

DAEWOO

INSTRUCTION MANUAL

TV/VCR COMBINATION

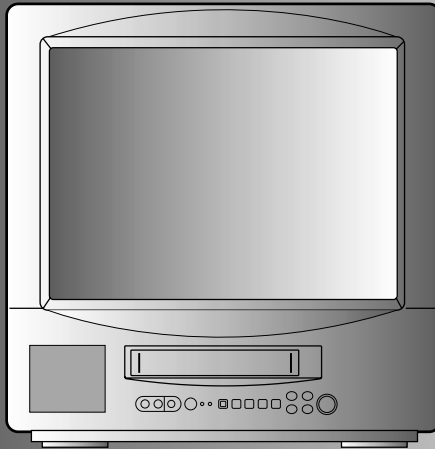

DVQ 14H1FC

DVQ 20H1FC

DVQ 14H2FC

DVQ 20H2FC

	CAUTION RISK OF ELECTRIC SHOCK DO NOT OPEN	
CAUTION : TO REDUCE THE RISK OF ELECTRIC SHOCK, DO NOT REMOVE COVER (OR BACK) NO USER-SERVICEABLE PARTS INSIDE. REFER SERVICING TO QUALIFIED SERVICE PERSONNEL.		



The lightning flash with arrowhead symbol, within an equilateral triangle, is intended to alert the user to the presence of uninsulated "dangerous voltage" within the product's enclosure that may be of sufficient magnitude to constitute a risk electric shock.



The exclamation point within an equilateral triangle is intended to alert the user to the presence of important operating and servicing instructions in the literature accompanying the appliance.

WARNING

TO PREVENT FIRE OR SHOCK HAZARD, DO NOT EXPOSE THIS APPLIANCE TO RAIN OR MOISTURE.

CAUTION

CHANGES OR MODIFICATIONS NOT EXPRESSLY APPROVED BY THE MANUFACTURER COULD VOID THE USER'S AUTHORITY TO OPERATE THE EQUIPMENT.

NOTE TO CATV SYSTEM INSTALLER

THIS REMINDER IS PROVIDED TO CALL THE CATV SYSTEM INSTALLER'S ATTENTION TO ARTICLE 820-40 OF THE NEC THAT PROVIDES GUIDELINES FOR PROPER GROUNDING AND, IN PARTICULAR, SPECIFIES THAT THE CABLE GROUND SHALL BE CONNECTED TO THE GROUNDING SYSTEM OF THE BUILDING, AS CLOSE TO THE POINT OF CABLE ENTRY AS PRACTICAL.

CAUTION

The AC power cord provided with this product is polarized (one blade wider than the other). To provide power to the TV, insert the AC plug into a standard 120V 60Hz polarized outlet.

NOTE

Never connect the plug to an electrical source other than one providing 120V 60Hz power. Use only the attached power cord. If the polarized AC cord does not fit into a non-polarized outlet, do not cut or file the blade. You are responsible for having the obsolete outlet replaced with a polarized outlet.

If you feel a static discharge when touching the unit, and the unit does not function, simply unplug the unit from the outlet. When you plug the unit back in, it should work normally.

Do not install power cords near any heating element or cooking appliances.

Precautions

LOCATION

For safe operation and satisfactory performance of your unit, keep the following in mind when selecting a place for its installation :

- Shield it from direct sunlight and keep it away from sources of intense heat.
- Avoid dusty or humid places.
- Avoid places with insufficient ventilation for proper heat dissipation. do not block the ventilation holes at the top and bottom of the unit.
do not place the unit on a carpet because this will block the ventilation holes.
- Install the unit in a horizontal position.
- Avoid locations subject to strong vibration.
- Do not place the unit near strong magnetic fields.
- Do not move the unit from a cold place to a hot place or vice versa (see the warning below).

AVOID THE HAZARDS OF ELECTRICAL SHOCK AND FIRE

- Do not handle the power cord with wet hands.
- Do not pull on the power cord when disconnecting it from an ac wall outlet. grasp it by plug.
- If, by accident, water is spilled on your unit, unplug the power cord immediately and take the unit to an authorized daewoo service center for servicing.
- Do not put your fingers or objects into the TV/VCR cassette holder.
- Do not place anything directly on top of the unit.

WARNING

Moisture condensation may occur inside the unit when it is moved from a cold place to a warm place, after heating in a cold room, or under conditions of high humidity. if a tape is played in a TV/VCR that has moisture, it may damage the tape and TV/VCR. when condensation occurs inside the unit, turn the power on and allow at least 2 hours for the unit to dry.

FCC WARNING

This equipment may generate or use radio frequency energy. changes or modifications to this equipment may cause harmful interference unless the modifications to this equipment may cause harmful interference unless the modifications are expressly approved in the instruction manual.

The user could lose the authority to operate this equipment if an unauthorized change or modification is made.

IMPORTANT COPYRIGHT INFORMATION

Unauthorized recording or use of broadcast television programming, video tape, film, or other copyrighted material may violate applicable copyright laws. we assume no responsibility for the unauthorized duplication, use or other acts which infringe upon the rights of copyright owners.

IMPORTANT SAFEGUARDS

PLEASE READ ALL THESE INSTRUCTIONS REGARDING YOUR TELEVISION EQUIPMENT AND RETAIN FOR FUTURE REFERENCE. FOLLOW ALL WARNINGS AND INSTRUCTIONS MARKED ON THE TV RECEIVER.

- 1 Read all of these instructions.
- 2 Save these instructions for later use.
- 3 Unplug this television equipment from the wall outlet before cleaning. Do not use liquid cleaners or aerosol cleaners. Use a damp cloth for cleaning.
- 4 Do not use attachments not recommended by the television equipment manufacturer as they may result in the risk of fire, electric shock or other personal injury.
- 5 Do not use this television equipment near water, for example, near a bathtub, wash-bowl, kitchen sink, or laundry tub, in a wet basement, or near a swimming pool, or the like.
- 6 Do not place this television equipment on an unstable cart, stand, or table. The television equipment may fall, causing serious injury to a child or adult, and serious damage to the equipment. Use only with a cart or stand recommended by the manufacturer, or sold with the television equipment. Wall or shelf mounting should follow the manufacturer's instructions, and should use a mounting kit approved by the manufacturer.
- 6A An appliance and cart combination should be moved with care. Quick stops, excessive force, and uneven surfaces may cause the appliance and cart combination to overturn.
- 7 Slots and openings in the cabinet and the back or bottom are provided for ventilation and to ensure reliable operation of the television equipment; and to protect it from overheating, these opening, must not be blocked or covered. The opening should never be blocked by placing the television equipment on a bed, sofa, rug, or other similar surface. (This equipment should never be placed near or over a radiator or heat register.) This television equipment should not be placed in a built-in installation such as a bookcase unless proper ventilation is provided.
- 8 This television equipment should be operated only from the type of power source indicated on the marking label. If you are not sure of the type of power supplied to your home, consult your television dealer or local power company.
- 9 This television equipment is equipped with a polarized alternating current line plug (a plug having one blade wider than the other). This plug will fit into the power outlet only one way. This is a safety feature. If you are unable to insert the plug fully into the outlet, try reversing the plug. If the plug should still fail to fit, contact your electrician to replace your obsolete outlet. Do not defeat the safety purpose of the polarized plug.
- 10 Do not allow anything to rest on the power cord. Do not locate this television equipment where the cord will be abused by persons walking on it.
- 11 Follow all warnings and instructions marked on the television equipment.
- 12 For added protection for this television equipment during a lightning storm, or when it is left unattended and unused for long periods of time, unplug it from the wall outlet and disconnect the antenna or cable system. This will prevent damage to the equipment due to lightning and power-line surges.



- 13** An outside antenna system should not be located in the vicinity of overhead power lines or other electric light or power circuits, or where it can fall into such power lines or circuits. When installing an outside antenna system, extreme care should be taken to keep from touching such power lines or circuits as contact with them might be fatal.
- 14** Do not overload wall outlets and extension cords as this can result in fire or electric shock.
- 15** Never push objects of any kind into this television equipment through openings as they may touch dangerous voltage points or short-out parts that could result in a fire or electric shock. Never spill liquid of any kind on the television equipment.
- 16** Do not attempt to service this television equipment yourself as opening or removing covers may expose you to dangerous voltage or other hazards. Refer all servicing to qualified service personnel.
- 17** Unplug this television equipment from the wall outlet and refer servicing to qualified service personnel under the following conditions:
- When the power-supply cord or plug is damaged or frayed.
 - If liquid has been spilled, or objects have fallen into the television equipment.
 - If the television equipment has been exposed to rain or water.
 - If the television equipment does not operate normally by following the operating instructions. Adjust only those controls that are covered by the operating instructions as an improper adjustment of other controls may result in damage and will often require extensive work by a qualified technician to restore the TV receiver to its normal operation.
 - If the television equipment has been dropped or the cabinet has been damaged.
 - When the television equipment exhibits a distinct change in performance - this indicates a need for service.

- 18** When replacement parts are required, be sure the service technician has used replacement parts specified by the manufacturer that have the same characteristics as the original part. Unauthorized substitutions may result in fire, electric shock or other hazards.
- 19** Upon completion of any service or repairs to this television equipment, ask the service technician to perform safety checks to determine that the television is in a safe operating condition.
- 20** If an outside antenna or cable system is connected to the television receiver, be sure the antenna or cable system is grounded so as to provide some protection against voltage surges and built-up static charges.

Section 810 of the National Electrical Code, ANSI/NFPA N0.70-1984, provides information with respect to proper grounding of the mast and supporting structure, grounding of the lead-in wire to an antenna discharge unit, size of grounding conductors, location of antenna-discharge unit, connection to grounding electrodes, and requirements for the grounding electrode.

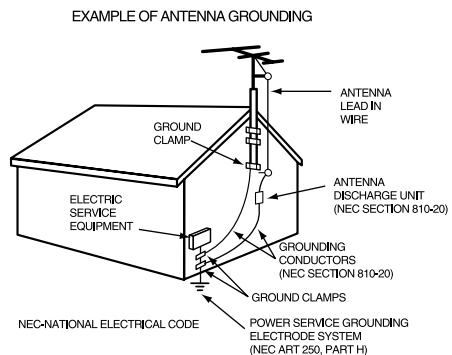

Table of Contents

Preface : Your New TV/VCR	2
Features	2
Unpacking Your TV/VCR	3
Chapter 1 : Overview of Your Equipment	4
Your TV/VCR's Front Panel	4
Your TV/VCR's Back Panel	5
Your Remote Controller	6
Chapter 2 : Connecting an Antenna or Cable to Your TV/VCR	9
Connecting an Antenna	9
Connecting a Cable System	11
Connecting Other Pieces of Equipment	12
Safety Notes	12
Chapter 3 : Operating Your TV	13
Turning Your TV/VCR On	13
Programming Your TV/VCR's Channel Memory	13
Changing channels	14
Changing the Volume	14
Changing the TV/VCR's Channel Memory	15
Displaying the TV/VCR's Status during TV operation	15
Adjusting Video Settings	16
Chapter 4 : Operating Your VCR	18
Video Cassette Tapes	18
Playing a Tape	19
Basic Recording	20
One Touch Recording (OTR)	21
Displaying the TV/VCR's Status during VCR Operation	22
Using the Counter (Zero Stop)	23
Chapter 5 : Using Timer Functions	24
Setting the Clock Automatically	24
Setting the Clock Manually	25
Setting the On Time	26
Setting the Off Time	26
Canceling the On Time or Off Time	27
Setting the Sleep Timer	28
Chapter 6 : Additional TV Features	29
Changing the Language of the On-Screen Menus	29
Captioning	29
CC on Mute	30
Power Restore	30
Parental Control Settings	31
Description of Parental Control Settings	32
Mini Glossary	33
Chapter 7 : Additional VCR Features	34
Programming to Record at a Later Time	34
Setting the Program Recording	35
Canceling the Program Record Settings	37
Displaying the Tape Counter	38
Auto Repeat PlayBack	39
Rental Play	39
Index Search (VISS)	40
Duplicating a Video Tape	41
Chapter 8 : Troubleshooting	42
Maintenance and specifications	43
Warranty	44

Your New TV/VCR

Congratulations on your purchase of a new Daewoo TV/VCR. We hope you find that your new TV/VCR provides you with years of reliable performance.

Your new TV/VCR is designed and engineered to provide you with the latest in features for your convenience. Listed below are just a few of the many features of your equipment.

Features

- **Auto Power On**

This feature automatically turns the TV/VCR on when you insert a cassette.

- **On-screen Programming**

You can use simple on-screen menus to perform all of the major operating features of your TV/VCR, including programming to record.

- **Tri-lingual Menus**

You can choose to display the on-screen menus in English, French or Spanish.

- **Auto Clock Setting**

Your TV/VCR can automatically set its internal clock based on a signal from local PBS stations.

- **Infrared Remote Control**

The remote control included with your TV/VCR allows you to complete almost all operations from the comfort of your easy chair.

- **181 Channel Capability**

Your TV/VCR has a advanced tuner that can receive up to 181 channels.

- **Closed Caption Decoder**

Your TV/VCR can decode the hidden text and captions that are broadcast with many shows and are included on many videotapes.

- **Record/Playback Speeds**

Your TV/VCR can recording to two speeds(SP, EP), playback to three speeds (SP, LP, EP). SP(Standard Play), LP(Long Play), EP (Extend Play)

- **Automatic Playback Speed Selection**

Your TV/VCR will automatically play a pre-recorded tape at the correct speed.

- **Still Frame Capability**

Your TV/VCR can display a single frame from a video tape.

- **Rental Play Mode**

This special setting improves the playback quality of worn tapes, especially rental tapes.

- **Repeat Playback**

You can set your TV/VCR to automatically repeat an entire video tape, or to repeat the recorded part of a videotape.

- **Video Index Search System (VISS)**

This feature allows you to find index marks on your tape quickly. Your TV/VCR places index marks at the beginning of each new recording.

- **One Touch Recording (OTR)**

You can quickly begin recording and set the length of time to record using just one button.

- **6 Events / 1 Month Timer Recording**

You can program up to six different recording sessions up to a month in advance.

- **Daily / Weekly Recording**

You can easily set your VCR to record every day at the same time, or to record every week at the same time.

- **Sleep Timer**

You can set your TV/VCR to turn off after a certain amount of time passes, from 15 minutes to 120 minutes.

- **On Timer**

You can set your TV/VCR to turn on at a certain time.

- **Parental Control**

Parental control is on the 31 page.

Unpacking Your TV/VCR

The following items are included with your TV/VCR. If these items are missing, please contact your Daewoo dealer immediately.

- 1 A remote control
- 2 A 300-ohm/75-ohm adaptor -> (13" only)
- 3 A rod antenna ("rabbit ears") -> (13" only)

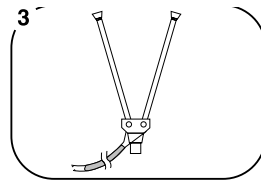
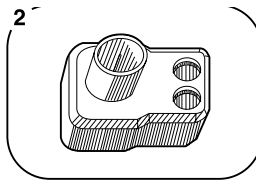
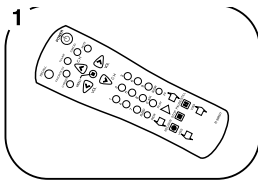

Overview of Your Equipment

Your TV/VCR's comes with a remote control. The section below summarizes the buttons, controls, and terminals that will use with your TV/VCR's.

Your TV/VCR's Front Panel

Below you will find short description of the buttons and indicators on the front panel. These are use following functions.

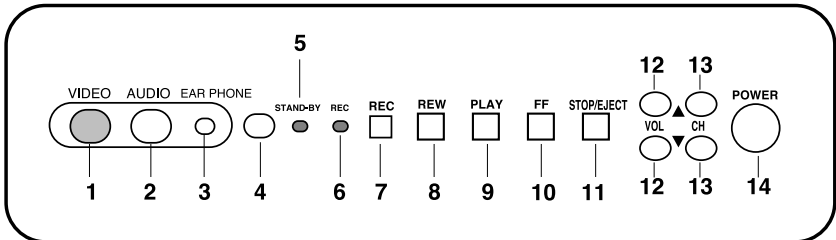

1 VIDEO in jack

Use this jack to receive a video signal from another A/V component.

2 AUDIO in jack

Use this jack to receive an audio signal from another A/V component.

3 EAR PHONE jack

Use this jack to the earphone (not supplied). The sound from the speaker is turned off.

4 Remote control receiver

This receiver receives a signal from your remote control. Do not block it.

5 STAND-BY (red) indicator

This indicator light up when the power is off.

6 REC (red/green) indicator

This indicator light up red when recording and light up green when timer program operating.

7 REC button

Press this button to begin recording. Press repeatedly to set a recording time using One-Touch Recording (OTR).

8 REW button

Press this button to rewind the tape.

9 PLAY button

Press this button to begin normal palyback of the tape

10 FF button (Fast Forward)

Press this button to fast forward the tape.

11 STOP/EJECT button

Press this button when the tape is moving to stop the tape. Press this button when the tape is stopped to eject it.

12 ◀VOL▶ buttons (volume)

Press these buttons to change your TV/VCR's volume.

13 ▼CH▲ buttons (channel)

Press these buttons to change channels on your TV/VCR. You will also use these buttons to adjust the tracking.

14 POWER button

Press this button to turn your TV/VCR on or off.

Your TV/VCR's Back Panel

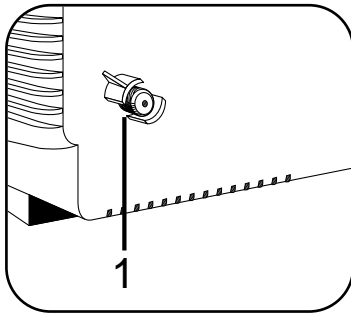

1 Antenna terminal

Use this terminal to attach an antenna or cable system to your TV/VCR.

Your Remote Controller

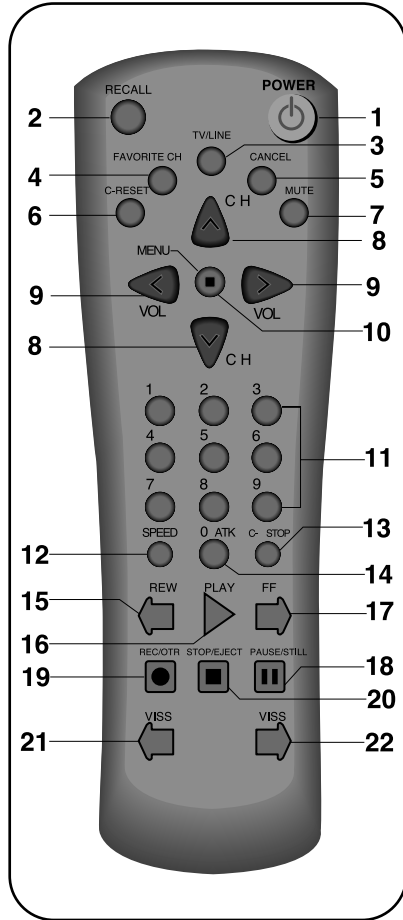

1. **POWER**
Press this button to turn your TV/VCR on or off.
2. **RECALL**
Press this button to display the current time, the counter, channel number and other status items.
3. **TV/LINE**
Press this button to select between viewing the signal coming from the antenna terminal (TV) or the signal coming from the A/V jack (LINE).
4. **FAVORITE CH**
Press this button to return to the previous channel you were watching.
5. **CANCEL**
Press this button to erase timer program recording settings.
6. **C-RESET**
Press this button to reset the counter to 0:00:00.
7. **MUTE**
Press to turn the TV/VCR's sound on and off.
8. **▼CH▲(TRK)**
Press these buttons to change channels on your TV/VCR, or select items in the menu system, or to adjust the tracking of a video tape during play-back.
9. **◀VOL▶**
Press these buttons to change your TV/VCR's volume, to activate selections in the menu system, or to change audio and video settings.

10. MENU

Press this button to turn the TV/VCR's menu system on and off.

11. 0-9

Press these buttons to change channels.

12. SPEED

Press this button to select the SP, EP tape speed when the tape recording.

13. C-ØSTOP

Press this button to find the counter zero.

14. 0(ATK)

Press this button to automatically set tracking point when the tape playback.

15. REW

Press this button to rewind the tape.

17. FF button (Fast Forward)

Press this button to fast forward the tape.

18. PAUSE/STILL

Press to temporarily stop the tape during recording or playback.

19. REC/OTR

Press this button to begin recording. Press repeatedly to set a recording time using One-Touch Recording (OTR)

20. STOP/EJECT

Press this button when the tape is moving to stop the tape. Press this button when the tape is stopped to eject it.

21. VISS -

Press this button to find the most recent index mark on tape and begin playing.

22. VISS +

Press this button to find the next index mark on tape and begin playing.

Installing Your Remote Control Batteries

1. Open the battery compartment on the back of the remote control.
2. Install two AAA-size batteries (not included) as shown. Make sure the “+” and “-” terminals are oriented correctly.
3. Replace the cover.

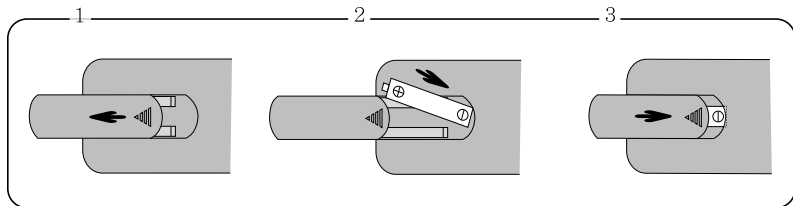

Notes

Do not mix different types of batteries, or mix an old and a new battery.

Remove and replace weak batteries. Weak batteries can leak and damage your controller. Dispose of batteries properly; never throw them into a fire.

Point your remote at the receiver on the center of the front of the TV/VCR. Make sure the receiver is not blocked.

The remote control can operate up to 30 feet away from the TV/VCR, if you are directly facing the front of the TV/VCR. Operating distance diminishes as you move to the sides of the TV/VCR.

Connecting an Antenna or Cable to Your TV/VCR

Your TV/VCR will provide you with the best performance if you connect it to an external antenna or cable system. Follow the directions below make this connection. Please note that you will normally only have to make one of the connections shown below, not all of them.

All connections will be made to the antenna terminal on the back of your TV/VCR. The antenna terminal is a silver metal post partially surrounded by two plastic tabs. For help in locating the antenna terminal, see “Your TV/VCR’s Back Panel” on page 5.

There is no antenna provided with your TV/VCR.

Connecting an Antenna

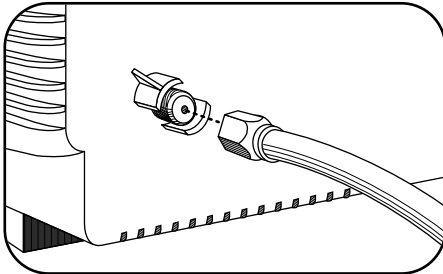

If your antenna ends in a single coaxial lead, simply press or screw the cable onto the antenna terminal on the back of your TV/VCR.

If your antenna ends in a pair of 300 ohm twin leads, you must use a 300-ohm/75-ohm adaptor. (An adaptor is included with your 13" TV/VCR.) Place the leads underneath the screws on the adaptor, tighten the screws, then press the adaptor onto the antenna terminal on the back of the TV/VCR.

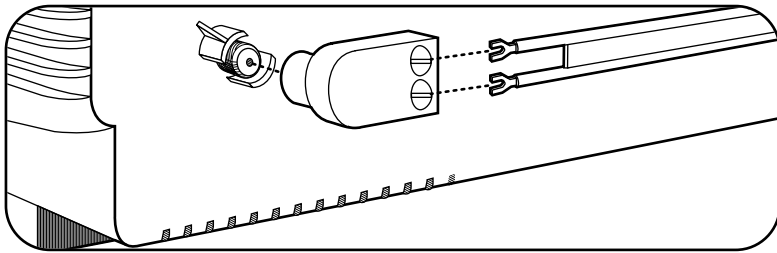

Antennas with two sets of leads

You might have two sets of leads from your antenna system, especially if you have one antenna for VHF signals and one antenna for UHF signals.

If your antenna system has both a coaxial lead and twin 300-ohm leads, you must obtain a combiner (available at your local electronics store). Press or screw the coaxial lead onto the combiner; place the twin leads underneath the screws on the combiner and tighten the screws. Press the cable from combiner onto the antenna terminal on the back of the TV/VCR.

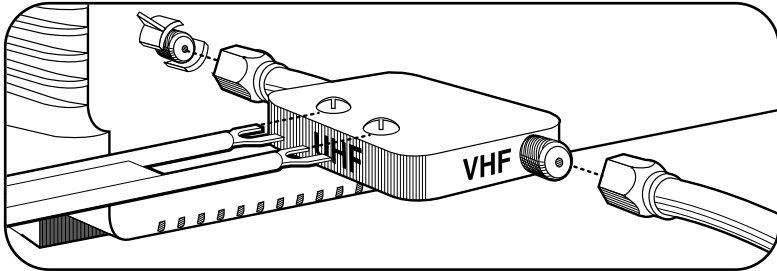

If your antenna system has two sets of twin 300-ohm leads, you must obtain a combiner (available at your local electronics store). Place one set of twin leads underneath the screws on the combiner and tighten the screws. Do the same with the other set of twin leads. Press the cable from the combiner onto the antenna terminal on the back of your TV/VCR.

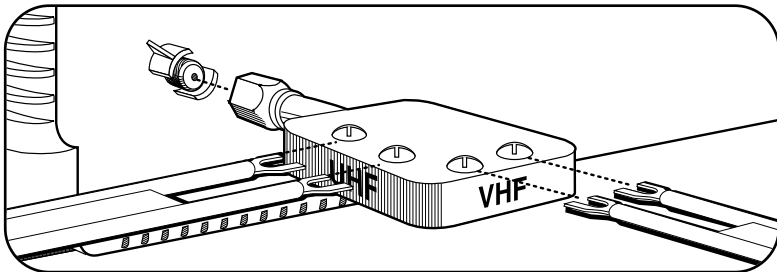

Connecting a Cable System

If your cable set-up is not described below, please contact your cable company for more information.

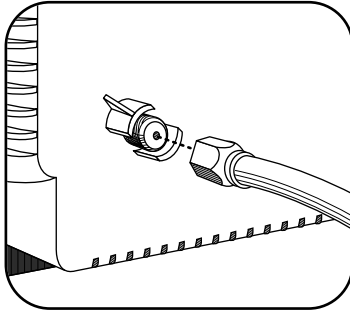

If your cable system does not require the use of a cable box, simply press or screw the incoming cable onto the antenna terminal on the back your TV.

If your cable system requires you to use a converter box for all channels, connect the incoming cable to the IN terminal on the converter box. Connect another cable between the OUT terminal on the converter box and the antenna terminal on the TV. You will need to keep your TV tuned to channel 3 or 4 and change channels using the converter box.

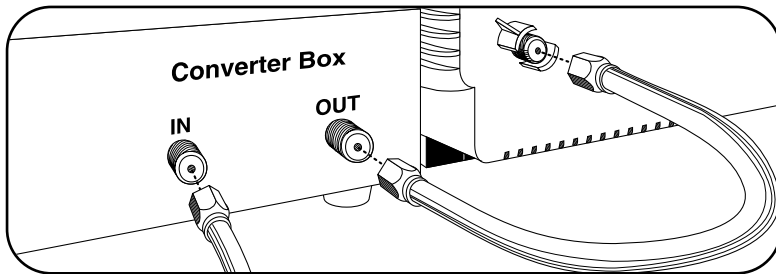

If your cable system only requires you to use a converter box for some channels (i. e. pay-TV channels), follow these steps: Find the primary incoming coaxial cable. Plug this cable into a splitter (available at your local electronics store). Connect one coaxial cable between one OUT terminal on the splitter and the IN terminal on the converter box. Connect another coaxial cable between the other OUT terminal on the splitter and the A-IN terminal on an A/B switch (available at your local electronics store.) Connect a third coaxial cable between the OUT terminal on the converter box and the B-IN terminal on the A/B switch. Finally, connect a coaxial cable between the OUT terminal on the A/B switch and the antenna terminal on the back of your TV/VCR.

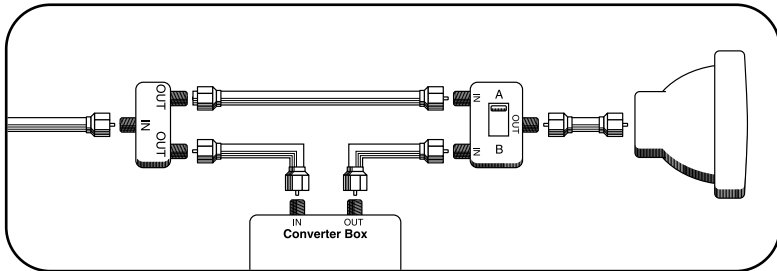

When the A/B switch is in the A position, you can change channels on the TV/VCR; when the A/B switch is in the B position, you need to change channels on the converter box (and your TV should be tuned to channel 3 or 4)

Connecting Other Pieces of Equipment

You may want to connect a VCR, laser disc player, satellite receiver, or another type of equipment to your TV/VCR. We recommend that you follow the instructions included with the piece of equipment you wish to connect.

If you connect other pieces of equipment to your TV/VCR using the audio/video jacks on the front panel, you will need to use the TV/LINE button on the remote control to view the signal coming through these jacks. See page 41 for more information.

Safety Notes

If you plan on being away from your home for an extended period of time, or if a thunderstorm is approaching, you should unplug your television, and you may wish to disconnect your TV from a rooftop or satellite antenna. You do not need to disconnect your TV from a cable system.

Operating Your TV

Once you have connected your TV/VCR to an antenna or cable system, plugged the TV in, and put batteries in the remote, you are ready to use the TV. The first thing you should do is program your TV/VCR so it memorizes all of available channels.

Turning Your TV/VCR On

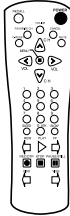

1. To turn your TV/VCR on, press the POWER button on the remote control. You can also use the POWER button on the front panel. Make sure your TV is plugged in before you try to turn it on.

Programming Your TV/VCR's Channel Memory

Your TV/VCR's memory determines the channels that are available using the ▲CH▼ buttons. If a channel is not in memory, you can tune to it with the number buttons, but not with the ▲CH▼ buttons. Follow these steps to program your TV/VCR's memory:

1. With the TV on, press the MENU button until "Set-Up" menu will be displayed.
2. Use the ▲CH▼ buttons to select "Reception", then use the VOL▶ button to select 'Air' or 'Cable'. If you connected an antenna to your TV/VCR, select 'Air'; If you connected a cable system, select 'Cable'.
3. Use the ▲CH▼ buttons to select "Memorize Channels", then use the VOL▶ button to enter the "Memorize Channels" process.
4. Press the MENU button to return to Set-Up menu.
5. Press the MENU button to return to normal TV viewing.

Your TV/VCR's channel memory will not be affected by a power outage. You will not need to re-program the memory unless you change the type of cable or antenna connected to your TV/VCR.

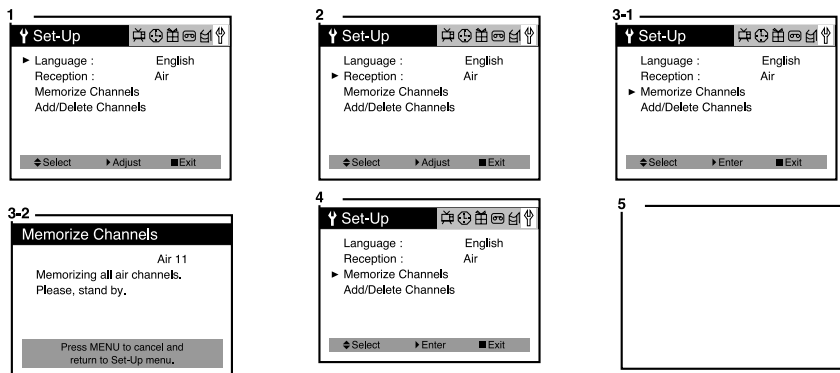

Changing Channels

You can change channels in three ways:

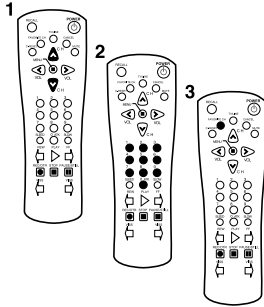

1. The ▲CH▼ buttons will take you through all memorized channels, one by one. The ▲CH▼ buttons will not access channels that have not been programmed into the TV's memory. For more information about programming channels into memory, see the section “Programming your TV/VCR's Channel Memory” on the previous page.
2. The number buttons (0-9) will take you to any channel, even if it has not been memorized. To change to a channel, enter its number; the TV/VCR will tune to the new channel when you enter the second digit of the channel.
3. The FAVORITE CH button will take you instantly to the last channel you were watching.

Changing the Volume

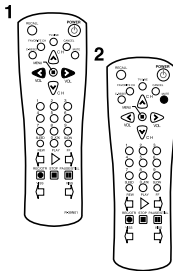

1. To change the volume of the TV/VCR set, use the ◀VOL▶ buttons on the remote or on the front panel.
2. To quickly turn off the sound, press the MUTE button on the remote. The ‘MUTE’ will appear on screen, colored green. To return the volume to its previous level, press MUTE again.

Changing the TV/VCR's Channel Memory

Your TV/VCR's memory determines the channels that are available using the ▲CH▼ buttons. You can add channels to this memory or remove them from memory. If a channel is removed from memory, you can tune to it with the number buttons, but you cannot tune to it with the buttons.

If there are just one channel memorized, then the Add/Delete Channels function will search the whole channels. But if there are two or more channel memorized, then the Add/Delete Channels function will search the memorized channels only.

Adding/Deleting a channel to memory

1. Use the number buttons to tune to the channel.
2. Press the MENU button until "Set-Up" menu will be displayed
3. Use the ▲CH▼ buttons to select "Add/Delete Channels", then use the VOL▶ button to enter the "Add/Delete Channels" process.
4. If the channel is not in memory, then use the ◀VOL▶ buttons to add the channel from memory.
5. If the channel is in memory, then use the ◀VOL▶ buttons to delete the channel from memory.
6. If you are going to delete other channel, then press the ▲CH▼ buttons until desired channel is selected. And press the ◀VOL▶ buttons to delete the channel.
7. Press MENU to exit.

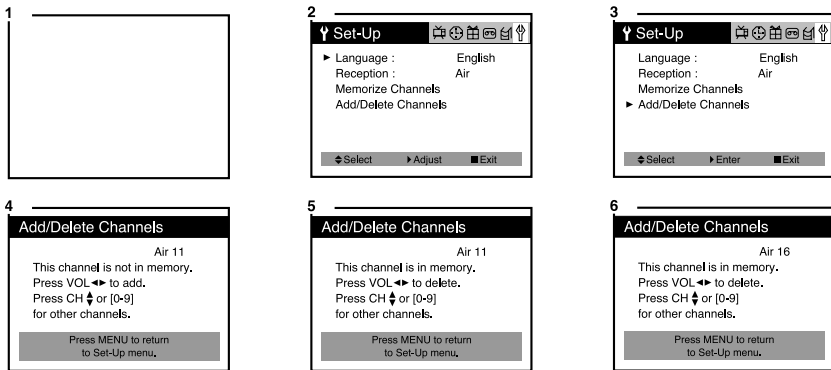

Displaying the TV/VCR's Status during TV Operation

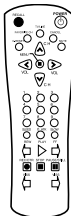

1. To quickly see the current channel number and status, press RECALL button on the remote control.
The current channel number and status will be displayed.

Adjusting Video Settings

You may wish to adjust the video settings (e. g. contrast or color) to obtain the most pleasing picture. To do so, follow these directions:

1. With the TV/VCR on, press the MENU button, then “Video” menu will appear.
2. The “Settings” item will be selected. Use the ◀VOL▶ buttons to turn Settings to Preset or Custom.
3. Use the buttons to select the video setting you wish to adjust.
4. Use the ◀VOL▶ buttons to adjust the video setting to the level you prefer.
5. When you are finished, press the MENU button until menu OSD will be disappeared.

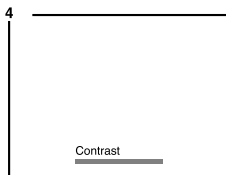
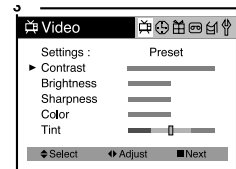
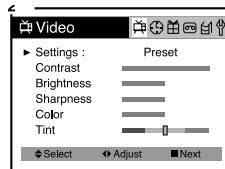
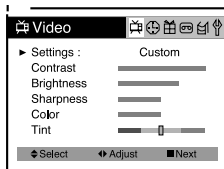

Returning to the factory settings

If you would like to return to the original video settings, as they were calibrated at the factory, follow these steps :

1. With the TV/VCR on, press the MENU button, then “Video” menu will appear.
2. Press the ◀VOL▶ buttons to set the “Settings” to ‘Preset’.

The TV/VCR will remember the ‘Custom’ settings you had previously chosen. When you set “Settings” to ‘Custom’ again, your previous custom settings will be restored.

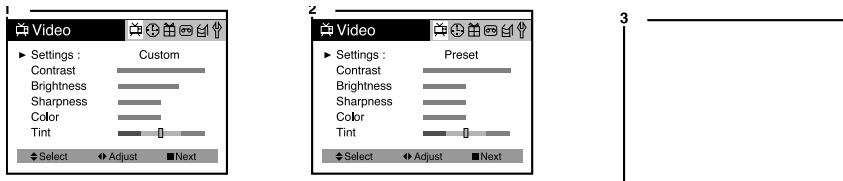

Descriptions of video settings

The contrast setting controls the relation between the light and black areas of the screen. If the light areas are too bright and are losing details, press the ◀VOL button; if the picture is gray and lacks contrast, press the VOL▶ button.

The brightness setting controls the overall amount of light in the picture. If the picture is too bright, press the ◀VOL button; if the picture is too dark, press the VOL▶ button.

The sharpness controls how the TV displays edges of objects on-screen. If the TV shows multiple vertical lines at the edges of an object, press the ◀VOL button; if the vertical edges of on-screen objects are fuzzy, press the VOL▶ button.

The color setting controls the intensity of color. If the color is over-saturated, press the ◀VOL button; if the color is washed out, press the VOL▶ button.

The tint setting controls the relationship of red and green in a picture. Tint is especially noticeable in flesh tones. If flesh tones seem too red or purple, press the ◀VOL button; if flesh tones are too green, press the VOL▶ button.

Operating Your VCR

Your TV/VCR has built-in VCR playback and recording capabilities, offering the ultimate in VCR convenience. This chapter explains the basic of using the VCR features of your unit.

Video Cassette Tapes

Your VCR uses VHS tapes. Only use tapes that have the official VHS mark:



Tape length/tape speed

VHS tapes come in different lengths, which, along with the tape speed, determine how much program time you can put on one tape. The following chart shows the maximum recording/playback time for each type of tape and each tape speed.

Type	SP (standard play)	LP (long play) (Play only)	EP (Extend play)
T-160	2 hours, 40 min.	5 hours 20 min	8 hours
T-120	2 hours	4 hours	6 hours
T-90	1hour 30 min.	3 hours	4 hours 30 min.
T-60	1 hour	2 hours	3 hours

Protecting your tapes

You can protect your tapes by removing the erasure prevention tab on the back of the tape. When this tab is removed, VCR cannot record over it. To once again be able to record on a tape with its tab removed, simply place a piece of tape over the space left by the removed tab.

Inserting a Tape

To insert a tape into your TV/VCR, hold it so that the windows on the tape face up, and the label of the tape faces away from the TV/VCR. Gently place the tape in the cassette compartment and push it in slowly. Once it is in the compartment part-way, the TV/VCR will pull the tape the rest of the way.

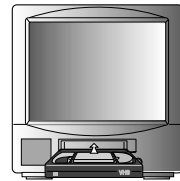

You can insert a tape into your TV/VCR even when it is turned off. If the tape has its erasure prevention tab removed, the TV/VCR will turn on and begin playing the tape.

Ejecting a tape

To remove a tape from the compartment, press the STOP/EJECT button on the front panel or on the remote control. The TV/VCR will eject the tape part-way. Grasp the cassette and remove the tape from the TV/VCR.

Playing a Tape

1. To begin playing a tape, place it in the TV/VCR's cassette compartment. If the erasure prevention tab has been removed, the tape will begin playing automatically. If the erasure prevention tab is intact, press the **PLAY** button on the front panel or on the remote control.
2. To pause the tape and display a still frame, press the **PAUSE/STILL** button on the remote control.
3. To stop the tape, press the **STOP/EJECT** button on the front panel or on the remote control.

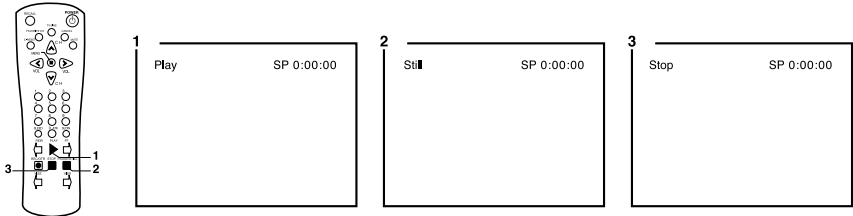

Searching for a scene

If you are looking for a particular scene, you can use the **FF** and **REW** buttons to find the scene faster.

1. Press the **FF** button during playback to search quickly in the forward direction. Press the **FF** button a second time to search at **7X** normal (in SP speed) or **11X** normal (in EP).

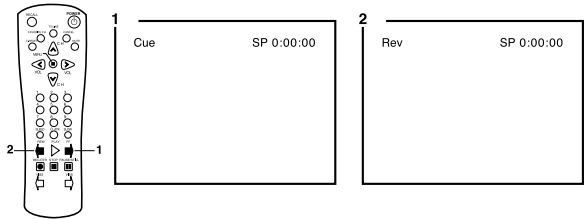

2. Press the **REW** button during playback to search quickly in the reverse direction. Press the **REW** button a second time to search at **7X** normal (in SP speed) or **11X** normal (in EP).

If you press **FF** or **REW** while the tape is stopped, the TV/VCR will quickly wind your tape in the selected direction. No picture from the tape will be displayed, but the tape moves at a much higher speed without the picture.

Tracking

“Tracking” is a term that describes how the TV/VCR “locks on” to the signal recorded on the tape. If the TV/VCR is not tracking correctly, the picture during playback will be jumpy and distorted.

Your TV/VCR is equipped with a sophisticated automatic tracking feature that can perfectly track a tape’s signal without adjustment from the user.

On some rare occasions, though, manual tracking may be required. To manually track a tape:

1. Begin playing back a tape.
2. Press and hold down the CH buttons on the remote control, one at a time. Adjust the tracking using these buttons until the picture is no longer distorted.

Basic Recording

Your TV/VCR makes it easy to record a program you are watching. To do this :

1. Place the tape on which you want to record in the cassette compartment. Fast forward or rewind to the point where you want to begin recording.
2. Tune to the channel you want to record.
3. Press the SPEED button repeatedly to select the tape speed at which you want to record : SP or EP
4. Press the REC/OTR button once. The tape will start recording the channel you are watching, and also add an index mark. The REC light on the front panel will light on red during recording.

If the tape has its erasure prevention tab removed, the tape will eject when your press REC/OTR button.

5. Press STOP/EJECT to stop recording.

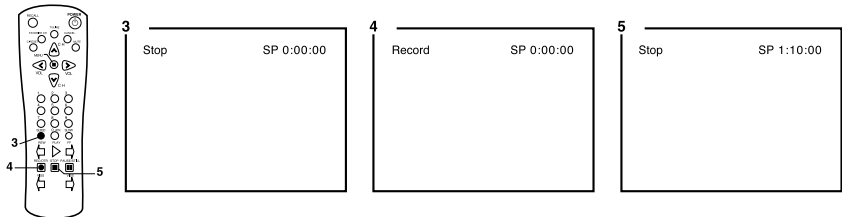

You cannot change channels while you are recording. To change channels, press PAUSE/STILL or STOP/EJECT to interrupt your recording.

If the tape reaches its end while recording, it will quit recording and eject the tape.

One Touch Recording (OTR)

One Touch Recording allows you to begin recording a channel, and also set how long you wish to record. The TV/VCR will automatically stop recording after the time you set has elapsed. To use OTR:

1. Follow steps 1-3 in “Basic Recording,” on the previous page, to begin recording.
2. Repeatedly press the REC/OTR button. Each time you press the REC/OTR button, 30 minutes is added to the OTR time, up to 4 hours.
3. When you have reached the length of time that you want the TV to record, stop pressing the OTR button. The TV/VCR will count down the time you set. When the timer reaches 00:00, recording will stop.
4. You can stop recording at any time by pressing STOP button.

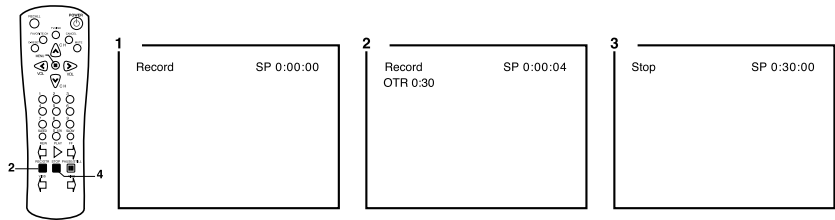

If you press the POWER button during OTR, the picture will turn off, but the tape will still record for the remainder of the OTR time. To stop recording, press STOP/EJECT.

To return to normal recording and cancel the OTR Time, press the REC/OTR button repeatedly until “4:00” is displayed, then press the REC/OTR button once more to return to normal recording.

If you program too much time into the OTR timer, continue to press the REC/OTR button. Once the time reaches “4:00,” press the REC/OTR button twice more to return to “0:30.”

You can not set an OTR time if the TV/VCR is recording a timer program.

Displaying the TV/VCR's Status during VCR Operation

If you have a tape in the TV/VCR's cassette compartment, you can display the following information.

1. Press the RECALL button. The current time, the current channel, the tape status (STOP, PLAY, REC, etc.), the tape speed, and the tape counter will be displayed.
2. Press the button a second time to see the current time, the current channel, the tape status, the tape speed, and the tape remain will be displayed. If the tape is playing, the current channel will not be displayed
3. Press the button a third time to return to normal viewing.

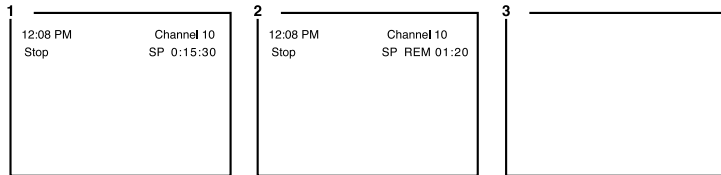

Using the Counter (Zero Stop)

The VCR counter can be used to keep track of your position on the tape. You can also use it to quickly return to a particular point on the tape. The counter cannot be displayed unless there is a cassette tape in the TV/VCR.

1. To display the counter, press the RECALL button until the counter is displayed in the right hand corner.
2. To reset the counter, press the C-RESET button on the remote control (0:00:00). The counter is also reset when you put a new cassette in your TV/VCR.
3. Press the MENU button until "Tape" menu will be displayed.
4. After play the tape, use the ▲CH▼ buttons to select the "Zero stop". If the press the VOL▶ button, you can quickly return to the 0:00:00.
5. The TV/VCR will rewind until it reaches the 0:00:00 mark on the counter, then it will stop. You can cancel the search for 0:00:00 by press the STOP button.
6. Press the C-ϕ STOP button on the remote control, you can quickly return to the 0:00:00.

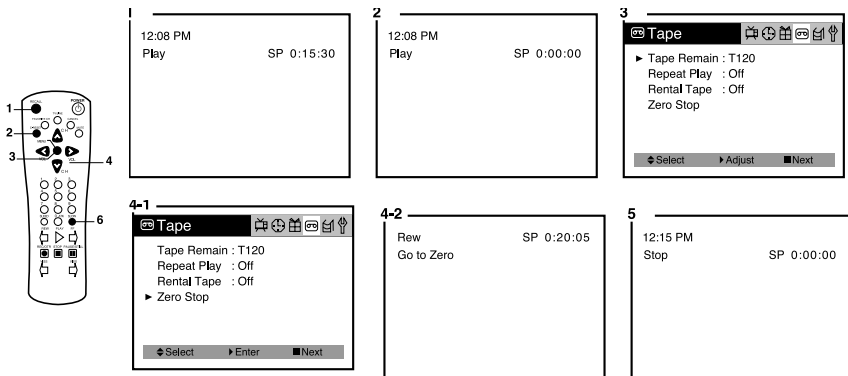

Using Timer Functions

Your TV/VCR has a built in-clock, and you can set the TV to turn on and off at times that you select. You can also set your TV to turn off after counting down a certain amount of time.

Setting the Clock Automatically

Your TV/VCR can automatically set its internal clock using a signal from a local PBS station. If you complete the following procedure, and your local PBS station is sending a time signal, then your TV/VCR will always show the correct time.

1. With the TV turned on, press the MENU button until “Time” menu is displayed.
2. The “Set Clock” item will be selected. Press the VOL▶ button twice, then “Auto” will be displayed in RED.
3. Press the ▲CH▼ buttons to display the “Auto Current Time Set” mode.
4. Use the ▲CH▼ buttons to set the PBS channel. If you don’t know the channel of the local PBS station, to set “Automatic”
5. Use the VOL▶ button to select “Time Zone”.
6. Press the ▲CH▼ buttons to select that corresponds to the time zone where you live. If you don’t know the time zone where you live, to set ‘Automatic’.
Press the ▲CH▼ buttons to change the Time Zone.
Automatic→Atlantic→Eastern→Central→Mountain→Pacific→
Alaska→Hawaii→Automatic
7. Use the VOL▶ button to select ‘DST’ (Daylight Savings Time).
8. Press the ▲CH▼ buttons to select DST “Automatic” “ON” “OFF”. (See the table blow)

Choose	To
Automatic	Select to set the daylight savings time automatically
ON	Select if your area uses daylight savings time
OFF	Select if your area does not use daylight savings time

9. Press the ■ MENU button to exit.
10. To activate the Automatic Clock setting, press the POWER button to turn off your TV/VCR. Leave the TV/VCR off for 4-5 minutes. When you turn the TV/VCR back on, the automatic clock should be set.

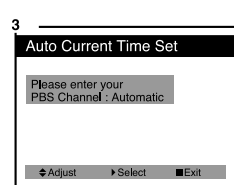
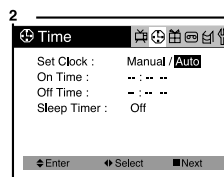
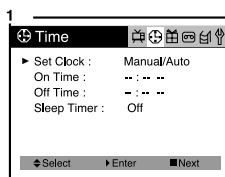

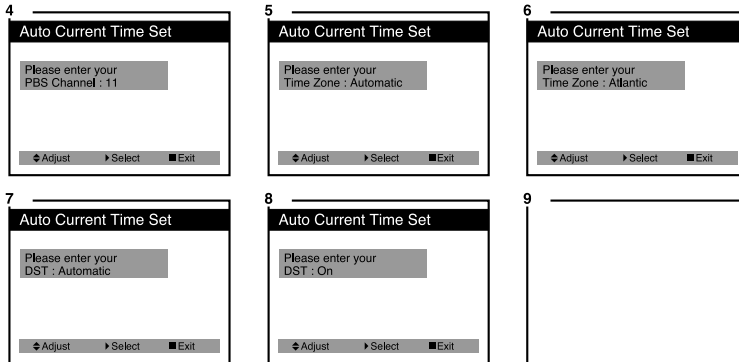

Setting the Clock Manually

If you are unable or not interested in using the Auto Clock feature, you can set your TV/VCR's clock manually.

1. With the TV turned on, press the MENU button until "Time" menu will be displayed.
2. The "Set Clock" item will be selected. Press the VOL▶ button once, then "Manual" will be displayed in RED.
3. Press the ▲CH▼ buttons to display the "Current Time Set" mode.
4. Use the ▲CH▼ buttons to set the month.
5. Press the VOL▶ button to select the day, year and time, use the ▲CH▼ buttons to setting.

If you hold down either ▲CH or CH▼ button, the corresponding numbers will change more quickly.

6. When the clock is set correctly, press the ■ MENU button to exit.

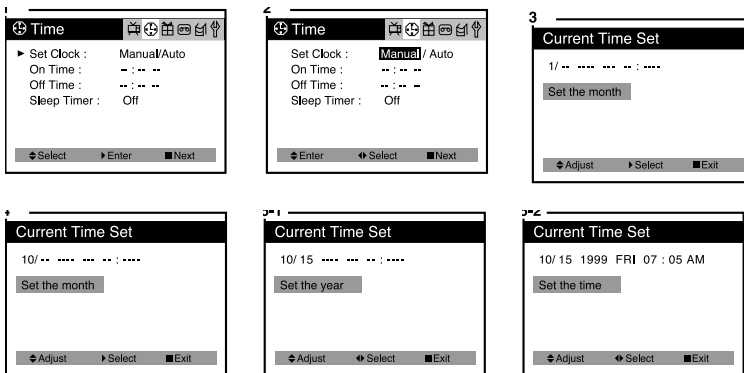



Setting the On Time

If you enter a time in the “On Time” setting, your TV/VCR will automatically turn on at that time.

Follow these instruction to set the “On Time”

1. With the TV turned on, press the MENU button until “Time” menu is displayed.
2. Use the ▲CH▼ buttons to select “On Time” item.
3. Press the VOL▶ button to display “On Time” in RED.
4. Press the ◀VOL▶ buttons to select the time and minute, press the ▲CH▼ buttons to time setting.
If you hold down either ▲CH or CH▼ button, the corresponding numbers will change more quickly.
5. When the clock is set correctly, press the ◀VOL▶ buttons to select “On Time” and use the ▲CH▼ buttons to select another “Time” function, or press the ■ MENU button to exit.

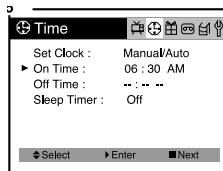
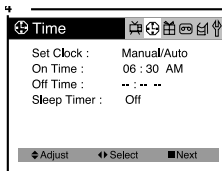
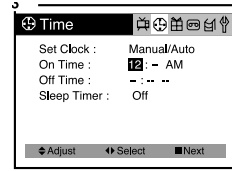
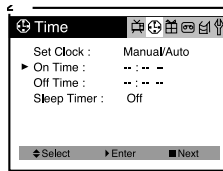
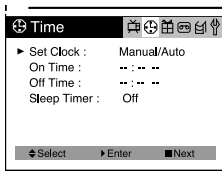

Setting the Off Time

If you enter a time in the “Off Time” setting, your TV/VCR will automatically turn off at that time.

Follow these instruction to set the “Off Time”

1. With the TV turned on, press the MENU button until “Time” menu will be displayed.
2. Use the ▲CH▼ buttons to select “Off Time” item.
3. Press the VOL▶ button to display “Off Time” in RED.

4. Press the ◀VOL▶ buttons to select the time and minute, press the ▲CH▼ buttons to time setting.
If you hold down either ▲CH or CH▼ button, the corresponding numbers will change more quickly.
5. When the clock is set correctly, press the ◀VOL▶ buttons to select “Off Time” and use the ▲CH▼ buttons to select another “Time” function, or press the ■ MENU button to exit.

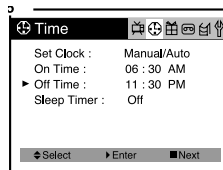
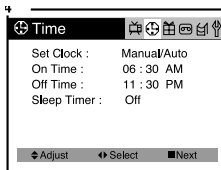
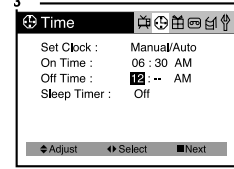
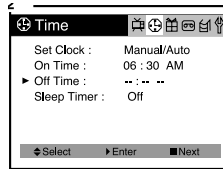
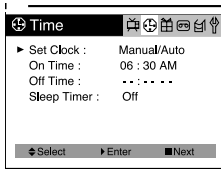

Canceling the On Time or Off Time

If you would like to cancel the On Time or Off Time, press the CANCEL button on the remote control. The On Time or Off time will not function correctly unless the clock has been set.

Setting the Sleep Timer

The sleep timer allows you to set an amount of time from 15 minutes to 2 hours.

TV/VCR count down the amount of time you set, then turn itself off.

To set the sleep timer:

1. With the TV turned on, press the MENU button until “Time” menu will be displayed.
2. Use the ▲CH▼ buttons to select “Sleep Timer” item.
3. Press the ◀VOL▶ buttons to set the sleep time. Each time you press the ◀VOL▶ buttons, you step between the available sleep times : 15min, 30min, 45min, 60min, 90min, or 120min.
4. When the clock is set correctly, press the ▲CH▼ buttons to select another “Time” function, or press the ■ MENU button to exit

To cancel the Sleep Timer, turn the TV/VCR off, or set the sleep time to “off” using one of the methods described above.

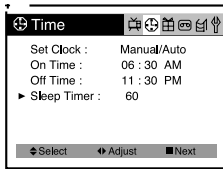
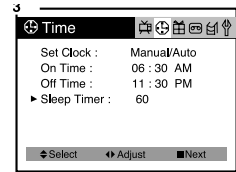
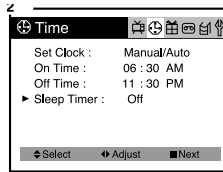
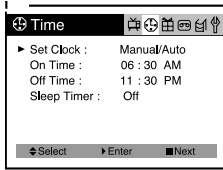

Additional TV Features

This section contains descriptions of the more advanced features of your TV.

Changing the Language of the On-Screen Menus

You can choose to display the on-screen menus in English, French, Spanish.
To change the on-screen language:

1. With the TV/VCR on, press the MENU button until “Set-Up” menu will be displayed.
2. The “Language” item will be selected. Press the VOL▶ button to select the language you want to use: French, Spanish.
3. To return normal TV viewing, press the MENU button until menu OSD will be disappeared.

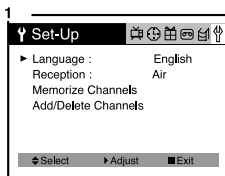

Captioning

Many TV shows contains “closed captions”. These captions are hidden words that can be displayed on your TV/VCR screen. There are two types of these words : “captions” usually follow the action on-screen, providing a written version of the dialogue, narration, and sound effects ; “text” is not usually related to the action on-screen, often providing information such as news or weather. A TV program might be providing more than one set of captions or one set of text.

To set your TV/VCR to display captions or text.

1. With the TV/VCR turned on, press the MENU button until “Special” menu will be displayed.
2. The “Closed Caption” item be selected. To turn captioning on, use the VOL▶ button to select Captions (CC1 or CC2) or Text (TEXT1, TEXT2)
At the time these instructions were written, only CC1 is normally available, but feel free to try the other selections.
3. Press the MENU button to return to normal TV viewing.
Your setting will remain intact until you change it.

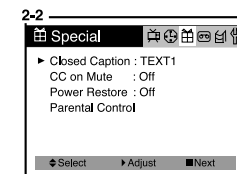
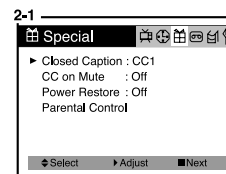
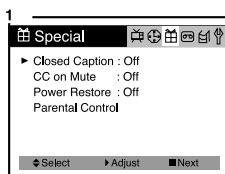

CC on Mute

When the sound is muted, user can select the caption display. It will display the caption content instead of sound mute.

1. With the TV turned on, press the MENU button until “Special” menu will be displayed.
2. Use the ▲CH▼ buttons to select “CC on Mute” item.
3. Use the VOL▶ button to select “CC1” or “CC2”.

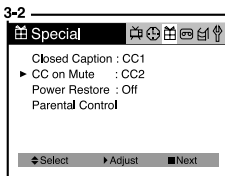
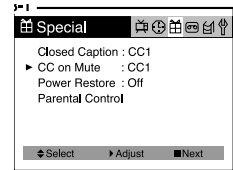
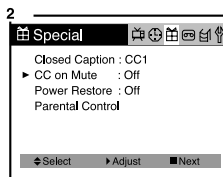
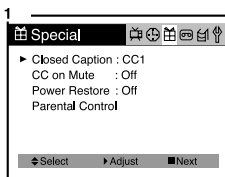

Power Restore

User can select the On/Off status when the power cord is put into the wall outlet. If user has a cable box with AC outlet, then user can connect the TV/VCR power cord to the AC outlet and control the TV/VCR without TV/VCR remote control. This function is rarely used for home use, so special care is needed while using.

1. With the TV/VCR turned on, press the MENU button until “Special” menu will be displayed.
2. Use the ▲CH▼ buttons select “Power Restore” item.
3. Use the VOL▶ button to select “On” or “Off”.

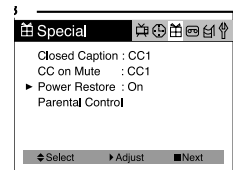
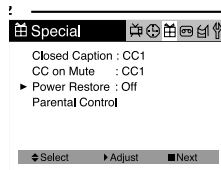
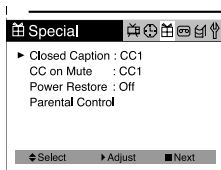

Parental Control Settings

This item help parents to set the standard for the programs which their children are going to watch.

1. With the TV/VCR turned on, press the MENU button until “Special” menu will be displayed.
 2. Use the ▲CH▼ buttons to select “Parental Control” item.
 3. Use the VOL▶ button to enter into “Parental Control” settings.
Set a 4-number password using the number keypad.
 4. Use the ▲CH▼ buttons to select Parental Control settings you wish to adjust.
- Descriptions of the Parental Control settings are on the next page.
5. Use the ◀VOL▶ buttons to adjust the Parental Control settings.
 6. Use the MENU button to return to the preview menu.

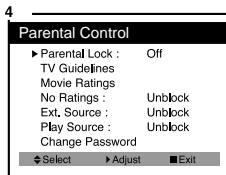
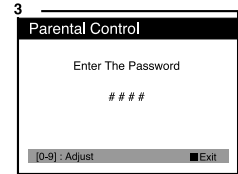
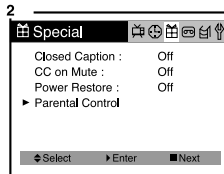
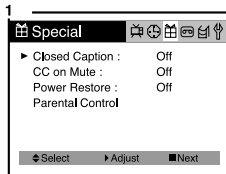

Description of Parental Control Settings

1. The Movie Ratings set the standard for movie, video, and other media excluding TV programs.

Use the ▲CH▼ buttons to select, ◀VOL▶ buttons to adjust.

2. The TV Guidelines set the standard for TV programs excluding sports and news.

Use the ▲CH▼ buttons to select, ◀VOL▶ buttons to adjust. You can set individual settings with ◀VOL▶ buttons.

3. The No Ratings item toggles between “Unblock” and “Block”.

This item determines whether to block or not the programs which are not rated by “Movie Ratings ” and “TV Guidelines”.

4. The Ext. Source item toggles between “Unblock” and “Block”.

5. The Play Source item toggles between “Unblock” and “Block”.

6. The Change Password item let you set or change the password for entering Parental Control item. Use the VOL▶ buttons to enter the password input display, and use the number buttons(0-9) to enter new password. After you entered the new password, confirmation display will appear. Try the password again.

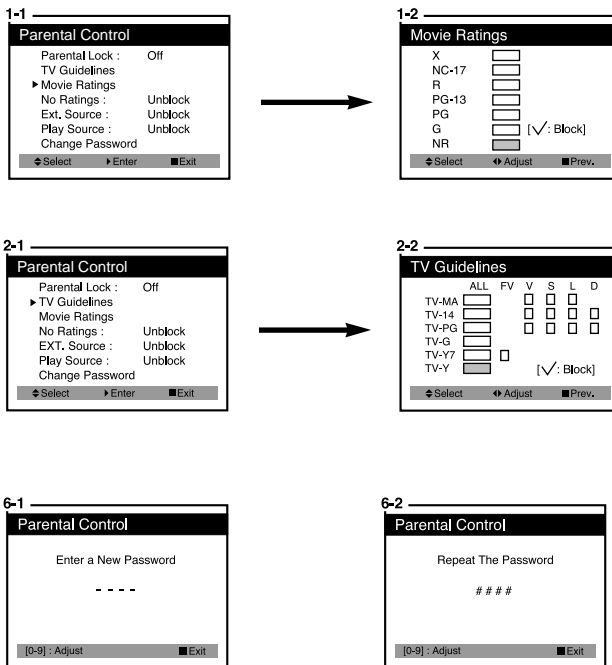

No Ratings means

1. When V-chip Data is error.
2. When any ratings are not detected.
3. Received a rating of “None” like news, sports, and emergency broadcast signals.

Mini Glossary

MOVIE RATING SYSTEM

X	Hard Core Films	Not for children under age 17 under any circumstance. Strong sexual content.
NC-17	Restrictd viewing	Same as X rating.
R	Restrictd viewing	Not for children under age 17. Strong element of sex and/or violence.
PG-13	Parental Guidance Suggested	Program is inappropriate for preteens, with a greater degree of offensive material than a PG rated program.
PG	Parental Guidance Suggested	Content is such that parents may not want their children to view the program.
G	General Audience	Content not offensive to most viewers.
NR	Not Rated	A motion picture that did not receive a rating for a variety of possible reasons.

TV PARENTAL GUIDELINE RATING SYSTEM

TV-MA	Mature Audience Only	Adults only, may contain Strong Dialog, Bad Language, Sex, and Violence Scenes.
TV-14	Parents Strongly Cautioned	Unsuitable for childern under 14, may contain Strong Dialog, Bad Language, Sex, and Violence Scenes.
TV-PG	Parental Guidance Suggested	Unsuitable for younger childern, may contain Suggestive Dialog, Bad Language, Sex, and Violence Scenes.
TV-G	General Audience	Considered suitable for all audiance; children may watch unattended.
TV-Y	Children	Consider suitable for all children under 7 years old.
TV-Y7	Children 7 and over	Consider suitable for children over 7, may contain Fantasy Violence Scenes.

FV=Fantasy Violence, V=Violence, S=Sex Scenes, L=Bad Language, D=Sexual Suggestive Dialog

Additional VCR Features

Programming to Record at a Later Time

One of the most convenient features of your new TV/VCR is the ability to record programs when you are not home. Your TV/VCR can be set to record up to six different programs at any time up to a month from now.

Getting ready

Before programming to record, keep the following things in mind :

- There must be a tape in the cassette compartment with its erasure prevention tab intact. The tape should be rewound or fast forwarded to the point where you want to begin recording.
- The clock must be set correctly.
- You should plan your programming sessions. If you program sessions that overlap, at least one your sessions will not be recorded correctly.
- The VCR buttons (PLAY, REW, FF) do not work during recording.

Setting the Program Recording

Here's an example of how to record a program broadcast on channel 26 from 8:00 PM to 9:00 PM Friday, 6th of February 1999, in EP mode.

1. With the TV/VCR turned on, press the MENU button until "Program" menu will be displayed.
2. Press the VOL ► button, then the today's date(Feb.05) appears in Red.
3. Press the ▲CH▼ buttons to set daily and weekly recording.
Press the ▲CH▼ buttons to setting changes as follows:
2/5(today) → 6 - - 28 → 1(next month) → 2 - - 4(next month) → Every SUN →
Every MON - - Every SAT → MON~FRI → SUN~SAT → 5(today).

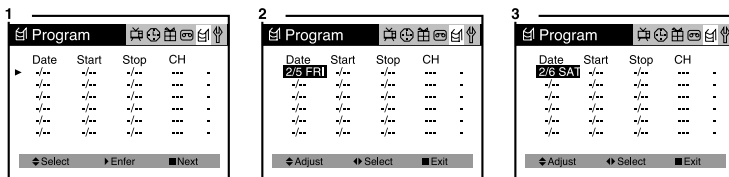

4. Press the VOL ► button, then set the hour of the recording Start time to "8" with the ▲CH▼ buttons.
5. Press the VOL ► button, then set the minute of the recording Start time to "00" with the ▲CH▼ buttons.
6. Press the VOL ► button, then set the hour of the recording Stop time to "9" with the ▲CH▼ buttons.

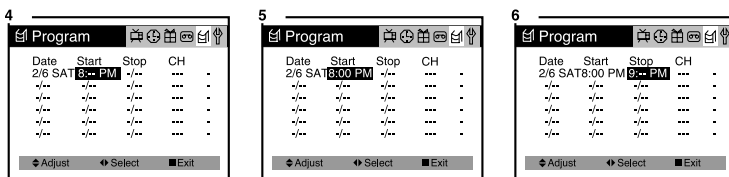

7. Press the VOL ► button, then set the minute of the recording Stop time to "00" with the ▲CH▼ buttons.
8. Press the VOL ► button, then set the channel to "26" with the ▲CH▼ buttons.
9. Press the VOL ► button, then set the recording speed to "EP" with the ▲CH▼ buttons.
You select the tape speed "AT" mode, default mode is set to "SP".
If the tape remain not to be enough, change the recording tape speed automatically "EP".

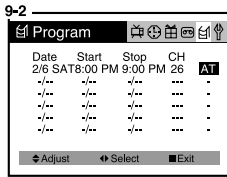
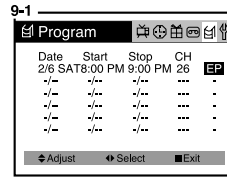
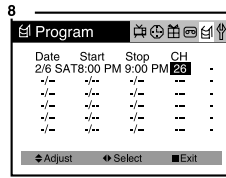
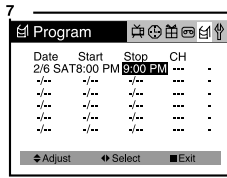

10. Press the VOL▶ button, then the cursor(▶) appears at the left margin
11. When you want to set other program, the CH▼ button to move the cursor(▶) to next line, then repeat step 2 through 10.
12. Press MENU to Exit the “Program” menu.

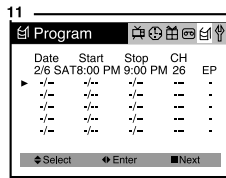
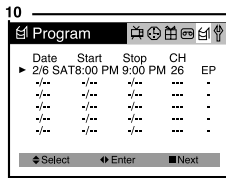

13. Press POWER to turn off the TV/VCR.
 The REC lamp on the front of the TV/VCR lights up to Green and the TV/VCR enters recording stand-by mode.
 The TV/VCR turn on automatically and start recording at the preset start time, and the REC lamp on the front of the TV/VCR changed from Green to Red.

Canceling the Program Record Settings

1. With the TV/VCR turn on, press the MENU button until “Program” menu will be displayed.
2. Using the ▲CH▼ buttons select the Program setting which you want to stop recording and press the CANCEL button.
3. Press the MENU button to exit the “Program” menu.

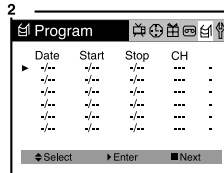
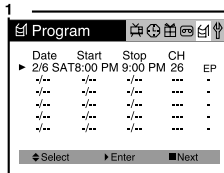

Displaying the Tape Counter

Press the RECALL button to display the tape counter. The tape counter shows the tape travel time in hours, minutes and seconds during recording or playback. Each time you press the RECALL button, the time counter and the remaining tape time counter appears alternately.

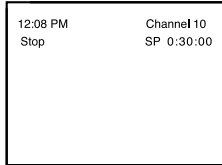

Time counter

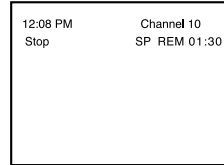

Remaining tape time counter

When you use a tape shorter than 120 minutes, set Tape Remain to T120. When you use a tape longer than 120 minutes, set Tape Remain to Others.

1. Press the MENU button until “Tape” menu will be displayed.
2. The “Tape Remain” item will be selected.
Press the VOL ► button to select “T120” or “Others”.
3. Press the MENU button until menu OSD will be disappeared.

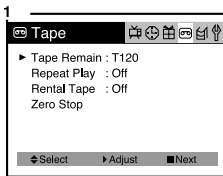

Auto Repeat PlayBack

You can set your TV/VCR to play a tape continuously. When you turn this feature on and start playing a tape, it will play to the end of the tape, then rewind to the beginning and start playing again. This will continue until you turn Auto Repeat Off.

1. Press the MENU button until “Tape” menu will be displayed.
2. Use the ▲CH▼ buttons to select “Repeat Play” item.
3. Press the VOL▶ button to select “On”.
4. Press the MENU button until menu OSD will be disappeared.

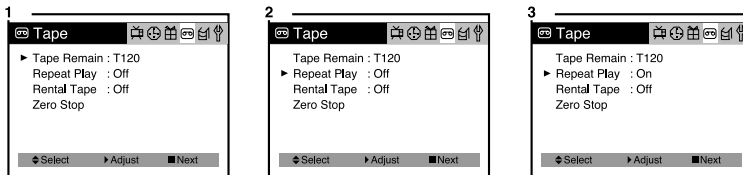

Rental Play

Your TV/VCR has a special video setting that improves the quality of worn video tapes, especially rental tapes. To use feature :

1. Press the MENU button until “Tape” menu will be displayed.
2. Use the ▲CH▼ buttons to select “Rental play” item.
3. Press the VOL▶ button to select “On”.
4. Press the MENU button until menu OSD will be disappeared.

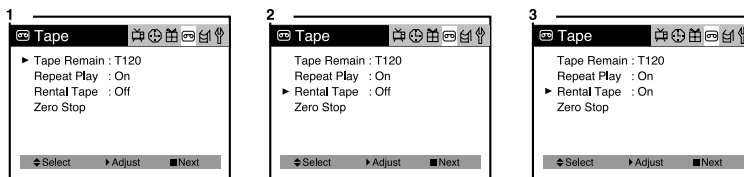

Index Search (VISS)

Your TV/VCR is equipped with the VHS Index Search System, or VISS. The VISS allows “index marks” to be placed on a video tape. These marks are similar to bookmarks - you can use the search system to quickly find these marks, and thereby find a point on the tape quickly.

Your TV/VCR automatically places an index mark on the tape every time it begins a recording session. Therefore, if you record six programs at six different times on a tape, there will be six index marks on the tape.

To search for an index mark:

1. Place a tape with index marks in your TV/VCR.
2. If the index mark is ahead on the tape, press the VISS+ button; if the index mark is behind on the tape, press VISS- button. The tape will fast forward or rewind (without picture) until it finds the index mark. Then, it will begin playing.
3. You can search further than the next index mark. For example, if you know that the show you want is three index marks behind, you can press the VISS- button three times. The TV/VCR will search for the third index mark, then begin playing.

VCRs and TV/VCRs from other manufacturers sometimes use the same VISS system.

Therefore, you may be able to search for index marks on tapes that were recorded on other VCRs.

Your TV/VCR cannot detect index marks unless they are least one minute apart on the tape.

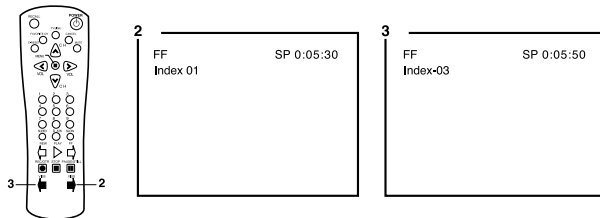

Duplicating a Video Tape

Because your TV/VCR has audio and video inputs, it is easy to make a copy of a tape, if you have another VCR or Video Camera. Follow these instructions :

1. Connect a audio cable from the AUDIO OUT jack on the VCR to the AUDIO jack on the front of your TV/VCR.
2. Connect a video cable from the VIDEO OUT jack on the VCR to the VIDEO jack on the front of your TV/VCR.

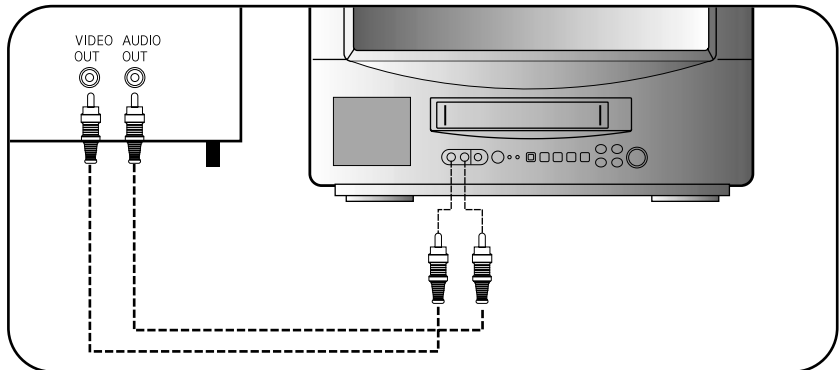

3. Press TV/LINE button on the remote control to set the TV/VCR to "LINE".
4. Insert the tape on which you want to record in the TV/VCR and set it to the point at which you want to begin recording.
5. Insert the tape from which you want to record in the VCR and set it to the point at which you want to begin recording.
6. Press the REC/OTR button on the TV/VCR.
7. Press the PLAY button on the VCR.
8. When you are finished recording, press the STOP button on both the TV/VCR and the VCR.

Troubleshooting

Your Daewoo television is designed to give you trouble-free performance for many years. If you have a problem with your TV, try the solutions listed below.

If the suggestions listed below do not solve your problem, contact your Daewoo dealer or an authorized Daewoo service center. You can also call Daewoo directly at 1-800-DAEWOO8.

There is no picture or sound, or the TV won't turn on.

- Make sure the TV is plugged in.
- Make sure the MUTE is not set.
- Make sure the power is on.
- If there is neither picture or sound, unplug the TV for 30 seconds, then plug it in and try again.

There is no picture or sound on some UHF channels.

- Try another station. If the other stations are OK, it may be a station problem.
- Check that the antenna is connected, is in good working order, has no broken wires, and is adjusted correctly.
- See if anything is interfering with the antenna signal.
- Make sure the AIR/CABLE setting is correct.

The sound is OK, but the picture is poor.

- Try another station. If the other stations are OK, it may be a station problem.
- Check that the antenna is connected and is in good working order, has no broken wires, and is adjusted correctly.

The picture is OK, but the sound is poor.

- Try another station. If the other stations are OK, it may be a station problem.
- Check that the antenna is connected, is in good working order, has no broken wires, and adjusted correctly.

There is poor reception on some channels.

- Try another station. If the other stations are OK, it may be a station problem.
- Check that the antenna is connected, is in good working order, has no broken wires, and is adjusted correctly.

You cannot tune to a cable channel.

- Make sure the AIR/CABLE setting is correct.
- The channel may not be programmed into memory.

The picture rolls, slants, shows lines, is grainy, has poor color, or has ghosts.

- Try another station. If the other station are OK, it may be a station problem.
- Check that the antenna is connected, is in good working order, has no broken wires, and is adjusted correctly.
- See if anything is interfering with the antenna signal.

The remote control does not work.

- Make sure the TV is plugged in.
- Make sure there are fresh batteries in the remote control.
- Make sure there is nothing blocking the remote control signal.

Servicing

Should your TV/VCR stop working, do not try to repair it yourself. There are no user-serviceable parts inside the unit. Turn the TV/VCR off, unplug the power cord, and take the unit to an authorized Daewoo repair center.

Cabinet Cleaning

To clean your TV/VCR, wipe it with a soft cloth that has been dampened with luke-warm water and wrung dry. Never use a solvent or alcohol. Never spray insecticides near your TV/VCR; such chemicals can cause damage and discoloration to the exterior of your TV/VCR.

Video Head Cleaning

If the picture is blurred or interrupted when palying back a tape, it may be caused by dirty video heads. Video heads can become dirty after long periods of playback, or from repeated use of rental tepes. To have your video heads cleaned, contact an authorized Daewoo repair center.

Specifications

Power Supply	AC 120V, 60Hz
Power Consumption	14H1FC/14H2FC : 60W; 20H1FC/20H2FC : 70W
Dimensions (WxHxD)	14H1FC/14H2FC : 382 x 404 x 365mm 20H1FC/20H2FC : 498 x 498 x 469mm
Weight	14H1FC/14H2FC : 14Kg ; 20H1FC/20H2FC : 23Kg
Channel Coverage	VHF : 2-13, CATV : 1, 14-125 ; UHF : 14-69
Video Signal System	NTSC Color
Picture Tube	13" or 19" diagonal
Antenna Input	VHF/UHF 75ohm, one input
VCR Format	VHS Standard
Tape Speed	SP : 33.35mm/sec ; LP : 16.67mm/sec ; EP : 11.12mm/sec
Playback Time	SP : 120min ; LP:240min; EP:360min (T-120 tape)
Speaker Output	8 Ohm, 1.3W
Video Input	1.0Vpp, 75 Ohm
Audio Input	3.8dBm, over 100K Ohm
Temperature	5°C to 40°C
Humidity	Less than 85%
Timer Programming	6 Events / 1 Month
Tuning System	Frequency Synthesized Tuning

Design and specifications are subject to changes without notice or legal obligaiton.

TELEVISION PRODUCT WARRANTY

Daewoo Electronics Canada Inc. (also known as DECI) warrants this product to be free from defects in material and workmanship and agrees to remedy any such defect. This warranty covers 3 years labor and 3 years parts from the date of original purchase. This warranty applies only to product purchased from an authorized DECI dealer and used within the boundaries of Canada. This warranty does not apply to product that has been improperly installed, subjected to usage for which the product was not designed, misused or abused, damaged during transportation, or which has been altered or repaired in any way that affects the reliability or detracts from its performance.

How to Obtain Warranty Service

Warranty service can only be provided by an authorized DECI Service center. For the closest authorized Service center to you, please contact your Dealer. In order to receive warranty service you must provide the authorized Service center with a copy of proof of purchase, signifying the date of purchase and the name of the Dealer from whom you purchased the product.

Statutory Warranties

The purchaser may have rights under existing provincial or federal laws, and where any terms of this warranty are prohibited by such laws, they are deemed null and void, but the remainder of the warranty shall remain in effect.

If you require further assistance, you may contact us at:

Daewoo Electronics Canada Inc.
170 Alden Road,
Markham, Ontario
L3R 4C1
Tel : (905) 415-7290
Fax : (905) 415-7287



This instrument is listed by Underwriter's Laboratories, Inc. It is designed and manufactured to meet rigid U.L. safety standards against X-radiation, fire, casualty and electrical hazards.



As an **ENERGY STAR**[®] Partner DAEWOO Electronics has determined that this product or product model meets the **ENERGY STAR**[®] guidelines for energy efficiency.



DAEWOO

Daewoo Electronics Canada Inc.

170 Alden Road

Markham, Ontario

L3R 4C1

Tel : (905) 415-7290