

HP Photosmart C5500 All-in-One series

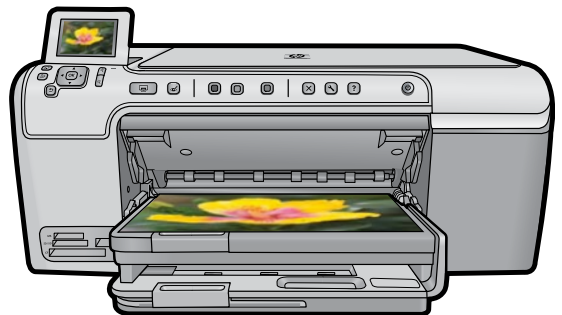

Windows Help



HP Photosmart C5500

All-in-One series



Contents

1	HP Photosmart C5500 All-in-One series Help	7
2	HP All-in-One overview	
	The HP All-in-One at a glance	9
	Control panel overview	10
	Control panel features	10
	Display icons	12
	Display sleep state	12
	Menu overview	12
	Copy Menu	12
	Photo Menu	13
	Scan Menu	13
	Setup Menu	13
	Help Menu	13
	Enter text using the visual keyboard	14
	Use the HP Photosmart Software	14
3	Find more information	17
4	Finish setting up the HP All-in-One	
	Set your preferences	19
	Set your language and country/region	19
	Set the default paper tray for PictBridge/DPOF/UPnP printing	20
	Enable faster browsing of photos	20
	Set the energy save mode	21
	Set the paper tray for printing from a Bluetooth device	21
	Restore the factory defaults	21
	Play a slideshow on the display	22
	Connect to a computer	23
	Connect to a Bluetooth® device	23
	What you need for a Bluetooth connection	23
	Connect the HP All-in-One to a computer using a Bluetooth® wireless connection	24
	Manage your Bluetooth settings	25
5	How do I?	31
6	Load originals and load paper	
	Load originals	33
	Choose papers for printing and copying	34
	Recommended papers for printing and copying	34
	Recommended papers and media for printing only	35
	Papers to avoid	36

Load paper.....	37
Load full-size paper or small-size photo paper.....	37
Load postcards, Hagaki, or index cards.....	40
Load envelopes.....	42
Load other types of paper.....	44
Load a CD/DVD.....	45
Avoid paper jams.....	49
7 Print from your computer	
Print from a software application.....	51
Make the HP All-in-One the default printer.....	52
Change the print settings for the current job.....	52
Set the paper size.....	52
Set the paper type for printing.....	53
View the print resolution.....	53
Change the print speed or quality.....	54
Change the page orientation.....	54
Scale the document size.....	55
Change the saturation, brightness, or color tone.....	55
Preview your print job.....	55
Change the default print settings.....	56
Printing shortcuts.....	56
Create printing shortcuts.....	57
Delete printing shortcuts.....	57
Perform special print jobs.....	58
Print a borderless image.....	58
Print a photo on photo paper.....	59
Print using Maximum dpi.....	60
Print onto a CD/DVD.....	61
Print on both sides of the page.....	62
Print a multiple-page document as a booklet.....	63
Print multiple pages on a single sheet.....	65
Print a multiple-page document in reverse order.....	65
Reverse an image for iron-on transfers.....	66
Print on transparencies.....	67
Print a group of addresses on labels or envelopes.....	67
Print a poster.....	68
Print a Web page.....	69
Stop a print job.....	69
8 Use the photo features	
Insert a memory card.....	71
Print photos.....	72
Create special projects from your photos.....	74
Save photos to your computer.....	74

Edit photos using the control panel.....	75
Remove red-eye.....	75
Rotate a photo.....	75
Zoom and pan to crop a photo.....	76
Automatically enhance your photos.....	77
Print a frame around your photo.....	77
Adjust the brightness of your photos.....	78
Apply special color effects to your photos.....	78
9 Use the scan features	
Scan an image.....	81
Scan an original to a computer.....	81
Scan an original to a memory card.....	82
Edit a scanned image.....	83
Edit a scanned document.....	83
Stop scanning.....	84
10 Use the copy features	
Make a copy.....	85
Preview your copy job.....	86
Change the copy settings for the current job.....	86
Set the number of copies.....	87
Set the copy paper size.....	87
Set the copy paper type.....	87
Change copy speed or quality.....	88
Adjust the lightness and darkness of your copy.....	89
Change default copy settings.....	89
Perform special copy jobs.....	90
Resize an original to fit onto letter or A4 paper.....	90
Crop an original.....	91
Shift the left margin.....	91
Improve the quality of a copy.....	92
Stop copying.....	92
11 Use the reprint features	
Make reprints of your photos.....	93
Edit a photo before reprinting.....	93
Fix a faded original.....	93
Rotate a photo.....	94
Zoom and pan to crop a photo.....	94
Adjust the brightness of your photos.....	95
Apply special color effects to your photos.....	96

12 Maintain the HP All-in-One

Work with print cartridges.....	97
Handle the print cartridges.....	98
Check the estimated ink levels.....	98
Replace the print cartridges.....	99
Use a photo print cartridge.....	103
Use the print cartridge protector.....	103
Remove ink from your skin and clothing.....	104
Ink-backup mode.....	105
Advanced print cartridge maintenance.....	105
Print a self-test report.....	114
Clean the HP All-in-One.....	115
Clean the glass.....	115
Clean the lid backing.....	115
Clean the exterior.....	116
Turn off the HP All-in-One.....	116

13 Shop for ink supplies..... 117**14 Troubleshooting**

View the Readme file.....	119
Setup troubleshooting.....	119
The product will not turn on.....	120
After setting up the product, it does not print.....	123
Uninstall and reinstall the software.....	130
Paper jams.....	131
Information on paper.....	132
Print quality troubleshooting.....	133
Wrong, inaccurate, or bleeding colors.....	133
Ink is not filling the text or graphics completely.....	136
The printout has a horizontal band of distortion near the bottom of a borderless print.....	138
Printouts have horizontal streaks or lines.....	139
Printouts are faded or have dull colors.....	141
Printouts seem blurry or fuzzy.....	144
Printouts are slanted or skewed.....	145
Ink streaks on the back of the paper.....	146
Paper is not picked up from the input tray.....	147
The text edges are jagged.....	148
Print troubleshooting.....	149
Envelopes print incorrectly.....	150
The product is not responding.....	151
The product prints meaningless characters.....	154
Nothing happens when I try to print.....	154
The margins are not printing as expected.....	158
Text or graphics are cut off at the edge of the page.....	159
A blank page came out while printing.....	161

Memory card troubleshooting.....	162
The Attention light blinks when I insert my memory card or storage device.....	163
The product does not read the memory card.....	164
The photos on the memory card do not transfer to my computer.....	165
Photos in a connected digital camera with PictBridge do not print.....	167
Scan troubleshooting.....	167
Scan fails.....	168
Text is incorrect or missing.....	170
The scan feature does not work.....	171
Copy troubleshooting.....	172
Nothing happens when I try to copy.....	172
Fit to Page is not working as expected.....	174
The image is cropped when I make a borderless copy.....	175
A borderless copy has white space around the edges.....	176
CD/DVD print troubleshooting.....	177
The product does not detect the CD/DVD holder.....	177
The product does not detect a CD/DVD on the holder.....	179
The product is printing on a non-printable area of my disc.....	180
The ink on the CD/DVD is not drying.....	181
Errors.....	182
Product messages.....	182
File messages.....	230
General user messages.....	232
Paper messages.....	237
Power and connection messages.....	242
Print cartridge messages.....	245

15 HP warranty and support

Warranty.....	269
Print cartridge warranty information.....	269
Support process.....	269
Before you call HP support.....	270
HP support by phone.....	270
Phone support period.....	271
Placing a call.....	271
After the phone support period.....	271
Additional warranty options.....	271
HP Quick Exchange Service (Japan).....	272
HP Korea customer support.....	272
Prepare the HP All-in-One for shipment.....	273
Remove the print cartridges before shipment.....	273
Remove the control panel faceplate.....	273
Pack the HP All-in-One.....	274

16 Technical information

Specifications.....	277
---------------------	-----

Environmental product stewardship program.....	278
Paper use.....	278
Plastics.....	279
Material safety data sheets.....	279
Recycling program.....	279
HP inkjet supplies recycling program.....	279
Energy Star® notice.....	279
Disposal of waste equipment by users in private households in the European Union.....	280
Regulatory notices.....	280
Regulatory model identification number.....	281
FCC statement.....	281
Notice to users in Korea.....	282
VCCI (Class B) compliance statement for users in Japan.....	282
Notice to users in Japan about the power cord.....	282
Noise emission statement for Germany.....	282
Toxic and hazardous substance table.....	282
Declaration of conformity (European Economic Area).....	283
HP Photosmart C5500 All-in-One series declaration of conformity.....	283
Index.....	285

1 HP Photosmart C5500 All-in-One series Help

For information about the HP All-in-One, see:

- [“HP All-in-One overview”](#) on page 9
- [“Find more information”](#) on page 17
- [“Finish setting up the HP All-in-One”](#) on page 19
- [“How do I?”](#) on page 31
- [“Load originals and load paper”](#) on page 33
- [“Print from your computer”](#) on page 51
- [“Use the photo features”](#) on page 71
- [“Use the scan features”](#) on page 81
- [“Use the copy features”](#) on page 85
- [“Use the reprint features”](#) on page 93
- [“Maintain the HP All-in-One”](#) on page 97
- [“Shop for ink supplies”](#) on page 117
- [“HP warranty and support”](#) on page 269
- [“Technical information”](#) on page 277

2 HP All-in-One overview

Use the HP All-in-One to print documents or photos from your computer, print photos directly from a memory card or storage device, scan documents or photos, make copies, or print directly on the surface of specially coated CDs and DVDs. HP papers that are specifically designed for the type of project you are printing produce the best results.

The HP All-in-One also provides built-in templates that you can use to print narrow- and wide-ruled notebook paper, graph paper, or music sheets that are perfect for your child's homework assignments. You can even print a task checklist to keep track of your list of things to do.

This section contains the following topics:

- [The HP All-in-One at a glance](#)
- [Control panel overview](#)
- [Menu overview](#)
- [Enter text using the visual keyboard](#)
- [Use the HP Photosmart Software](#)

The HP All-in-One at a glance

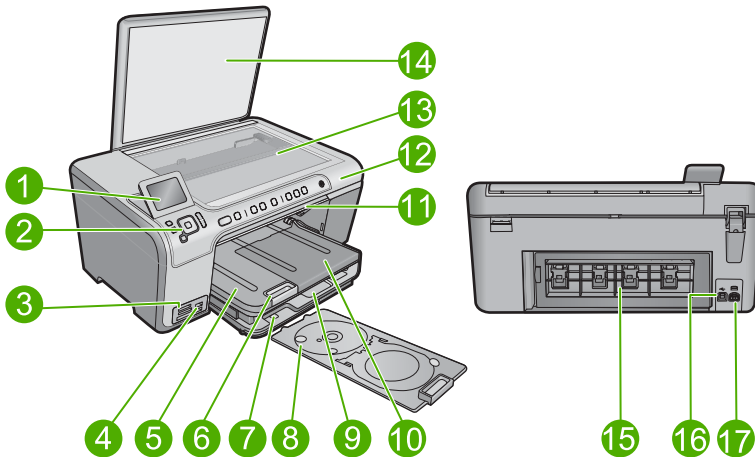

Label	Description
1	Color graphics display (also referred to as the display)
2	Control panel
3	Memory card slots and Photo light
4	Front USB port
5	Output tray

(continued)

Label	Description
6	Paper tray extender (also referred to as the tray extender)
7	CD/DVD holder storage
8	CD/DVD holder
9	Main input tray (also referred to as the input tray)
10	Photo tray
11	CD/DVD access door
12	Print cartridge door
13	Glass
14	Lid backing
15	Rear door
16	Rear USB port
17	Power connection*

* Use only with the power adapter supplied by HP.

Control panel overview

This section describes the functions of the control panel buttons and lights, as well as the icons and sleep state on the display.









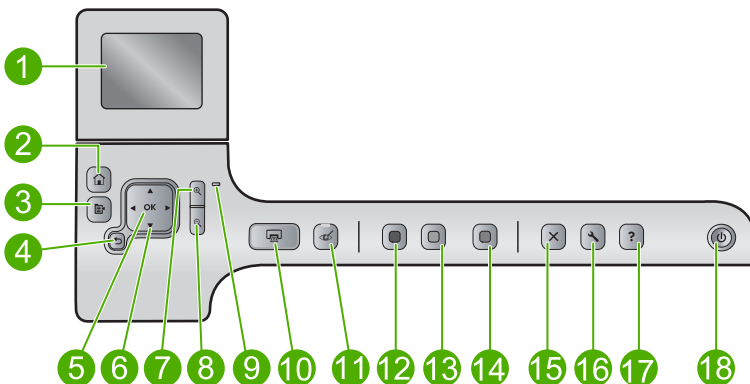







This section contains the following topics:

- [Control panel features](#)
- [Display icons](#)
- [Display sleep state](#)

Control panel features





The following diagram and related table provide a quick reference to the HP All-in-One control panel features.



Label	Icon	Name and Description
1		Color graphics display (also referred to as the display): Displays menus, photos, and messages. The display can be pulled up and angled for better viewing.
2		Home: Returns to the Home screen (the default screen when you turn on the product).
3		Menu: Presents a set of options related to the current display.
4		Back: Returns to the previous screen on the display.
5	OK	OK : Selects a menu setting, value, or photo on the display.
6		Directional pad: Allows you to navigate through photos and menu options by pressing the up, down, left, or right arrow buttons. If you are zooming in on a photo, you can also use the arrow buttons to pan around the photo and select a different area to print.
7		Zoom in + : Zooms in to enlarge the image on the display. You can also use this button together with the arrows on the directional pad to adjust the crop box for printing.
8		Zoom out - : Zooms out to show more of a photo. If you press this button when a photo is shown on the display at 100%, the Fit to Page feature is applied to the photo automatically.
9		Attention light: Indicates a problem occurred. See the display for more information.
10		Print Photos : Prints the photos selected on your memory card. If no photos are currently selected, the product prints the photo currently showing on the display.
11		Red-Eye Removal : Turns the Red-Eye Removal feature on or off. This feature turns on when a memory card is inserted. The product automatically corrects red-eye coloring in all the photos in the print queue.
12		Start Copy Black : Starts a black-and-white copy.
13		Start Copy Color : Starts a color copy.
14		Start Scan : Opens the Scan Menu where you can select a destination for your scan.
15		Cancel: Stops the current operation.
16		Setup : Opens the Setup menu where you can change product settings and perform maintenance functions.
17		Help : Opens the Help Menu on the display where you can select a topic to learn more about it. From the Home screen, pressing Help lists the topics for which help is available. Depending on the topic you select, the topic will appear on the display or on your computer screen. When viewing screens other than the Home screen, the Help button provides help applicable to the current screen.
18		On: Turns the product on or off. When the product is off, a minimal amount of power is still used. To completely remove power, turn off the product, and then unplug the power cord.

Display icons

The following icons can appear at the top right side of the display to provide important information about the HP All-in-One.

Icon	Purpose
	Shows that the ink level in all the print cartridges is 50% or more.
	Shows that one or more of the print cartridges are low on ink. You should replace the print cartridge when the print quality is no longer acceptable.
	Shows that an unknown print cartridge is inserted. This icon might appear if a print cartridge contains non-HP ink.
	Indicates that the Printer and PC Adapter with Bluetooth® Wireless Technology is connected to the front USB port.

Display sleep state

To prolong the life of the display, the HP All-in-One returns to the Home screen after 10 minutes of inactivity. After 15 minutes of inactivity, the display goes into a sleep state and the screen shuts off completely. The display turns back on when you press a control panel button, insert a memory card, lift the lid, or access the HP All-in-One from a connected computer.

Menu overview

The following topics provide a quick reference to top-level menus available from the Home screen and buttons on the control panel.

- [Copy Menu](#)
- [Photo Menu](#)
- [Scan Menu](#)
- [Setup Menu](#)
- [Help Menu](#)

Copy Menu

When you select **Copy** on the Home screen, the **Number of copies** screen appears. The following options are available when you press the Menu button from the **Number of copies** screen.

Size
Quality

Lighter/Darker
Preview
Crop
Paper Size
Paper Type
Margin Shift
Enhancements
Set as New Defaults

Photo Menu

The following options are available when you select **Photo** from the Home screen or insert a memory card.

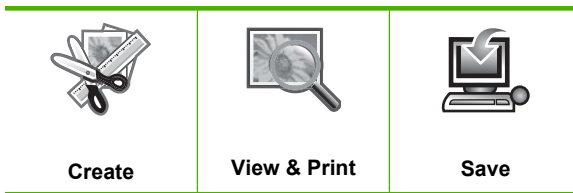

Scan Menu

The following options are available when you press **Start Scan** on the control panel or select **Scan** from the Home screen.

Scan and Reprint
Scan to Computer
Scan to Memory Card
Scan to USB Flash Drive

Setup Menu

The following options are available when you press **Setup** on the control panel.

Printable School Papers
Tools
Preferences
Bluetooth

Help Menu

The **Help Menu** provides quick access to key help topics. It is available if you press **Help** when the Home screen is showing on the display. If you select one of the first six topics, the help appears on the display. If you select one of the remaining topics, the help appears on your computer. The following options are available.

Use Control Panel

(continued)

Insert Print Cartridges
Load Printable CD/DVD
Load Paper in Photo Tray
Load Paper in Main Tray
Load Original on Scanner
How Do I...
Error Messages
General Troubleshooting
Use Memory Card
Get Support

Enter text using the visual keyboard

You can enter text or symbols by using the visual keyboard that automatically appears on the display when you need to enter text. For example, the visual keyboard automatically appears when you are setting up the Bluetooth device name.

To enter text using the visual keyboard

1. To select a letter, number, or symbol in the visual keyboard, press the arrows on the directional pad to highlight the appropriate selection.

To enter lowercase letters, uppercase letters, numbers, and symbols

- To enter lowercase letters, select the **abc** button on the visual keyboard, and then press **OK**.
 - To enter uppercase letters, select the **ABC** button on the visual keyboard, and then press **OK**.
 - To enter numbers, select the **123** button on the visual keyboard, and then press **OK**.
 - To enter symbols, select the **.@!** button on the visual keyboard, and then press **OK**.
2. After you highlight the appropriate letter, number, or symbol, press **OK** on the control panel to select it.
The selection appears on the display.

 **TIP:** To erase a letter, number, or symbol, select **Clear** on the visual keyboard, and then press **OK**.

3. When you are finished entering text, numbers, or symbols, select **Done** on the visual keyboard, and then press **OK**.

Use the HP Photosmart Software





The HP Photosmart Software provides a fast and easy way to make prints of your photos. It also provides access to other basic HP imaging software features, such as saving and viewing your photos.

For more information on using the HP Photosmart Software:

- Check the **Contents** panel on the left. Look for the **HP Photosmart Software Help contents** book at the top.
- If you do not see the **HP Photosmart Software Help contents** book at the top of the **Contents** panel, access the software help through the HP Solution Center.

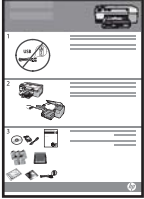
3 Find more information

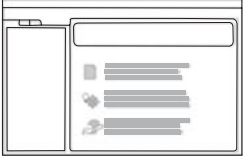
You can access a variety of resources, both printed and onscreen, that provide information about setting up and using the HP All-in-One.

	<p>Start Here guide</p> <p>The Start Here guide provides instructions for setting up the HP All-in-One and installing software. Make sure you follow the steps in the Start Here guide in order.</p> <p>If you have problems during setup, check the Start Here guide for troubleshooting information, or see "Troubleshooting" on page 119 in this onscreen Help.</p>
	<p>Basics Guide</p> <p>The Basics Guide contains an overview of the HP All-in-One, including step-by-step instructions for basic tasks, troubleshooting tips, and technical information.</p>
	<p>HP Photosmart animations</p> <p>The HP Photosmart animations, located in the relevant sections of the onscreen Help, show you how to complete key tasks on the HP All-in-One. You will learn how to load paper, load a CD/DVD, insert a memory card, and replace the print cartridges.</p>
	<p>Onscreen Help</p> <p>The onscreen Help provides detailed instructions on using all features of the HP All-in-One.</p> <ul style="list-style-type: none">• The How Do I? section provides links so you can quickly find information on performing common tasks.• The HP All-in-One overview section provides general information about the main features of the HP All-in-One.• The Troubleshooting section provides information about resolving errors you might encounter with the HP All-in-One.
	<p>Readme</p> <p>The Readme file contains the most recent information which might not be found in other publications.</p> <p>Install the software to access the Readme file.</p>
<p>www.hp.com/support</p>	<p>If you have Internet access, you can get help and support from the HP Web site. This Web site offers technical support, drivers, supplies, and ordering information.</p>

4 Finish setting up the HP All-in-One

After you have completed the steps in your Start Here guide, refer to this section to help you finish setting up the HP All-in-One. This section contains important setup-related information for your product.

This section contains the following topics:

- [Set your preferences](#)
- [Connect to a computer](#)
- [Connect to a Bluetooth® device](#)

Set your preferences

Before you begin using your product, you should review and, if necessary, adjust the general settings described in this section.

This section contains the following topics:

- [Set your language and country/region](#)
- [Set the default paper tray for PictBridge/DPOF/UPnP printing](#)
- [Enable faster browsing of photos](#)
- [Set the energy save mode](#)
- [Set the paper tray for printing from a Bluetooth device](#)
- [Restore the factory defaults](#)
- [Play a slideshow on the display](#)

Set your language and country/region

The language setting determines which language the HP All-in-One uses to show messages on the display. The country/region setting determines the default paper sizes and layouts for printing. You can change these settings at any time by using the following procedure.

To set your language and country/region

1. Press **Setup**.



2. Press the down arrow button to highlight **Preferences**, and then press **OK**.
3. Press the down arrow button to highlight **Set Language**, and then press **OK**.
4. Press the down arrow button to scroll through the languages. When the language you want to use is highlighted, press **OK**.

5. When prompted, press the down arrow button to highlight **Yes** for confirmation, and then press **OK**.
The **Preferences** menu reappears.
6. Press the down arrow button to highlight **Set Country/Region**, and then press **OK**.
7. Press the down arrow button to scroll through the countries/regions. When the country/region you want to use is highlighted, press **OK**.
8. When prompted, press the down arrow button to highlight **Yes** for confirmation, and then press **OK**.

Set the default paper tray for PictBridge/DPOF/UPnP printing

You can set the default paper tray to use when you print photos from a Pictbridge device, DPOF file, or a Universal Plug and Play (UPnP) device. This setting only applies to print jobs where the paper size settings are not specified on the Pictbridge device, DPOF file, or the UPnP device.

To set the default paper tray

1. Press **Setup**.



2. Press the down arrow button to highlight **Preferences**, and then press **OK**.
3. Press the down arrow button to highlight **Device-Printer Tray Select**, and then press **OK**.
4. Press the down arrow or the up arrow button to highlight one of the following, and then press **OK**.
 - **Prompt for Tray**: This option prompts for selecting a tray whenever a print job is sent.
 - **Photo Tray**: This selects the photo tray.
 - **Main Tray**: This selects the main input tray.

Enable faster browsing of photos

You can set up the HP All-in-One to enable faster photo browsing by writing small thumbnails to the memory card. The thumbnails take up a relatively small amount of space and are used to speed up the browsing performance of photos on the card.



NOTE: This feature is on by default.

To turn faster browsing on or off

1. Press **Setup**.



2. Press the down arrow button to highlight **Preferences**, and then press **OK**.

3. Press the down arrow button to highlight **Enable Faster Browsing**, and then press **OK**.
4. Press the down arrow or the up arrow button to highlight **On** or **Off**, and then press **OK**.

Set the energy save mode

When you turn off the HP All-in-One, it goes into Energy Save mode by default. This makes the product more energy efficient, but also means it can take longer than expected to turn the product on. If you want to reduce the start-up time, you can turn off the Energy Save mode.

 **NOTE:** This feature is on by default.

To turn energy saving mode on or off

1. Press **Setup**.



2. Press the down arrow button to highlight **Preferences**, and then press **OK**.
3. Press the down arrow button to highlight **Energy Save Mode**, and then press **OK**.
4. Press the down arrow or the up arrow button to highlight **On** or **Off**, and then press **OK**.

Set the paper tray for printing from a Bluetooth device

Set the default paper tray to use when you print photos from a Bluetooth device.

To set the paper tray for printing from a Bluetooth device

1. Press **Setup**.



2. Press the down arrow button to highlight **Bluetooth**, and then press **OK**.
3. Press the down arrow button to highlight **Bluetooth Tray Select**, and then press **OK**.
4. Press the down arrow button to highlight **Main Tray** or **Photo Tray**, and then press **OK**.

Restore the factory defaults

You can restore the current settings to what they were when you purchased the HP All-in-One.

 **NOTE:** Restoring the factory defaults will not affect any changes you made to scan settings and the language and country/region settings.

You can perform this process from the control panel only.

To restore the factory defaults

1. Press **Setup**.



2. Press the down arrow button to highlight **Tools**, and then press **OK**.
3. Press the down arrow button to highlight **Restore Factory Defaults**, and then press **OK**.

The factory default settings are restored.

Play a slideshow on the display

You can set up the HP All-in-One to play a slideshow on the display, similar to a screensaver on a computer, when you are not using the product.

There are two types of slideshows that you can enable:

- **Demo Mode**: appears after the HP All-in-One is inactive for one minute. The HP All-in-One shows interactive slides that enable you to try various features of the product. If **Demo Mode** is on, the product will not go to a low power sleep mode. **Demo Mode** is off by default.



NOTE: HP recommends leaving **Demo Mode** off.

- **Tips Slideshow**: appears only after you print from the computer. The HP All-in-One shows a short set of slides with information describing special features available on the product. The slideshow plays twice and then the display returns to the Home screen. **Tips Slideshow** is on by default.

To turn the demo mode on or off

1. Press **Setup**.



2. Press the down arrow button to highlight **Tools**, and then press **OK**.
3. Press the down arrow button to highlight **Demo Mode**, and then press **OK**.
4. Press the down arrow or the up arrow button to highlight **On** or **Off**, and then press **OK**.

To turn the tips slideshow on or off

1. Press **Setup**.



2. Press the down arrow button to highlight **Tools**, and then press **OK**.
3. Press the down arrow button to highlight **Tips Slideshow**, and then press **OK**.
4. Press the down arrow or the up arrow button to highlight **On** or **Off**, and then press **OK**.

Connect to a computer

The HP All-in-One comes equipped with a rear USB 2.0 High Speed port for connection to a computer.

If you use a USB cable to connect the HP All-in-One to a computer on a network, you can set up printer sharing on your computer. This enables other computers on the network to print to the HP All-in-One, using your computer as the host.

The **host** computer (your computer, connected directly to the HP All-in-One by a USB cable) has full software functionality. Other computers, which are referred to as the **clients**, have access only to the print features. HP recommends up to 5 computers for the best performance. You must perform other functions from the host computer or from the control panel on the HP All-in-One.

To connect the product with the USB cable

- ▲ Refer to the Start Here guide that came with your product for information on connecting to a computer with a USB cable.



NOTE: Do not connect the USB cable to the product until you are prompted to do so.

To enable printer sharing on a Windows computer

- ▲ Refer to the user guide that came with your computer or see the Windows onscreen Help.

Connect to a Bluetooth® device

If you insert an HP Bluetooth Adapter (such as the HP bt500) into the front USB port, you can print to the HP All-in-One from Bluetooth devices such as PDAs, camera phones, and computers.

This section contains the following topics:

- [What you need for a Bluetooth connection](#)
- [Connect the HP All-in-One to a computer using a Bluetooth® wireless connection](#)
- [Manage your Bluetooth settings](#)

What you need for a Bluetooth connection

To connect the HP All-in-One with a Bluetooth connection, you will need the following:

- A Bluetooth capable device (such as a PDA, camera phone, or computer)
- An HP Bluetooth Adapter

Some Bluetooth products exchange device addresses when they communicate with each other, so you might also need to find out the device address of the HP All-in-One in order to establish a connection.

To find out the device address of the product

1. Insert the HP Bluetooth Adapter into the front USB port.
2. Press **Setup**.



3. Press the down arrow button until **Bluetooth** is highlighted, and then press **OK**.
4. Press the down arrow button until **Device Address** is highlighted, and then press **OK**.
The **Device Address** appears, which is read only.
5. Make a note of the device address. You might need it later.

Connect the HP All-in-One to a computer using a Bluetooth® wireless connection

A Bluetooth connection provides a quick and easy way to print images from a Bluetooth-enabled computer without using a cable. With a Bluetooth connection you can access many of the same printing features as with a USB connection. For example, you can check the printer status, as well as the estimated amount of ink remaining in your ink cartridges.

 **NOTE:** The only software functionality available with a Bluetooth connection is printing. Scanning and software-based copying cannot be done over a Bluetooth connection. However, stand-alone copy functions are still available.

Before you print, you must connect an HP Bluetooth Adapter to the HP All-in-One.

You must have Windows Vista or Windows XP and either the Microsoft Bluetooth® Protocol Stack or the Widcomm Bluetooth® Protocol Stack installed in order to connect the HP All-in-One. It is possible to have both the Microsoft Stack and the Widcomm Stack on your computer, but you use only one of them to connect the HP All-in-One.

- **Microsoft stack:** If you have Windows Vista or Windows XP with Service Pack 2 installed on your computer, then your computer has the Microsoft Bluetooth® Protocol Stack. The Microsoft stack allows you to install an external Bluetooth® adapter automatically. If your Bluetooth® adapter supports the Microsoft stack but it does not install automatically, then you do not have the Microsoft stack on your computer. Check the documentation that came with the Bluetooth® adapter to see if it supports the Microsoft stack.
- **Widcomm stack:** If you have an HP computer with Bluetooth® built in then your computer has the Widcomm stack. If you have an HP computer and plug in an HP Bluetooth Adapter, it will install automatically using the Widcomm stack.

To install and print using the Microsoft stack

1. Make sure that you have installed the product software on the computer.

 **NOTE:** The purpose of installing the software is to make sure the printer driver is available for the Bluetooth® connection. Therefore, if you have already installed the software, you do not need to reinstall it. If you want both a USB and a Bluetooth® connection to the product, install the USB connection first. For more information, see the Start Here guide. However, if you do not want a USB connection, select **Directly to the computer** on the **Connection Type** screen. Also, on the **Connect Your Device Now** screen, select the check box next to **If you are unable to connect your device now...** at the bottom of the screen.

2. Attach an HP Bluetooth Adapter to the front USB port of the product.
3. If you are using an external Bluetooth® adapter for your computer, make sure your computer is started and then attach the Bluetooth® adapter to a USB port on the computer. If you have Windows Vista or Windows XP with Service Pack 2, the Bluetooth® drivers are installed automatically. If you are prompted to select a Bluetooth® profile, select **HCRP**.
If your computer has Bluetooth® built in, just make sure the computer is started.
4. On the Windows taskbar, click **Start**, and then click **Printers and Faxes** (or click **Control Panel**, and then **Printers**).
5. Double-click the **Add Printer** icon (or click **Add a printer**).
6. Click **Next**, and then select **A Bluetooth Printer**.
7. Follow the onscreen instructions to finish the installation.
8. Print as you would to any printer.

To install and print using the Widcomm stack

1. Make sure that you have installed the product software on the computer.

 **NOTE:** The purpose of installing the software is to make sure the printer driver is available for the Bluetooth® connection. Therefore, if you have already installed the software, you do not need to reinstall it. If you want both a USB and a Bluetooth® connection to the product, install the USB connection first. For more information, see the Start Here guide. However, if you do not want a USB connection, select **Directly to the computer** on the **Connection Type** screen. Also, on the **Connect Your Device Now** screen, select the check box next to **If you are unable to connect your device now...** at the bottom of the screen.

2. Attach an HP Bluetooth Adapter to the front USB port.
3. Click the **My Bluetooth Places** icon on the desktop or in the taskbar.
4. Click **View devices in range**.
5. Once the available devices are discovered, double-click the name of the product to finish the installation.
6. Print as you would to any printer.

Manage your Bluetooth settings

You can manage Bluetooth settings for the HP All-in-One through the HP All-in-One control panel.

This section contains the following topics:

- [View and print Bluetooth settings](#)
- [Change the device name](#)
- [Set Bluetooth security for the HP All-in-One](#)
- [Reset Bluetooth settings on the HP All-in-One](#)

View and print Bluetooth settings

You can view and print the Bluetooth settings for the HP All-in-One through the HP All-in-One control panel.

To view and print Bluetooth settings

1. Press **Setup**.



2. Press the down arrow button until **Bluetooth** is highlighted, and then press **OK**.
3. Press the down arrow button until **View and print Bluetooth settings** is highlighted, and then press **OK**.

The product shows the Bluetooth settings on the display and then prints them.

The following table describes the Bluetooth settings shown on the configuration page.

Parameter	Description
Device Address	The hardware address of the Bluetooth device.
Device Name	The device name assigned to the product, which can identify it on a Bluetooth device.
Passkey	A value that the user must enter in order to print via Bluetooth.
Visibility	Shows whether or not the HP All-in-One is visible to Bluetooth devices that are within range. <ul style="list-style-type: none"> • Visible to all: Any Bluetooth device within range can print to the HP All-in-One. • Not visible: Only Bluetooth devices that have stored the device address of the HP All-in-One can print to it.
Security	The level of security set for an HP All-in-One connected by Bluetooth. <ul style="list-style-type: none"> • Low: The HP All-in-One does not require a passkey. Any Bluetooth device within range can print to it. • High: The HP All-in-One requires a passkey from the Bluetooth device before allowing the device to send a print job.

Change the device name

Some Bluetooth products display the name of the HP All-in-One when connected. If you do not want the default name displayed as the name of the HP All-in-One, you can change the device name.

To change the device name of the product

1. Press **Setup**.



2. Press the down arrow button until **Bluetooth** is highlighted, and then press **OK**.
3. Press the down arrow button until **Device Name** is highlighted, and then press **OK**.



NOTE: The product ships with the predefined name of **Photosmart C5500**.

4. Use the visual keyboard to enter a new name.
5. When you have finished entering a name for the product, press **OK**.
The name you entered will appear on your Bluetooth device when you connect to the product to print.
6. Press **OK** to exit the **Setup** menu.

Related topics

[“Enter text using the visual keyboard” on page 14](#)

Set Bluetooth security for the HP All-in-One

You can enable the product security settings through the **Bluetooth** menu on the HP All-in-One. From the **Bluetooth** menu, you can:

- Ensure passkey authentication prior to someone printing to the HP All-in-One from a Bluetooth device.
- Make the HP All-in-One visible or invisible to Bluetooth devices that are within range.

This section contains the following topics:

- [Set the security level](#)
- [Set the HP All-in-One to be invisible to Bluetooth devices](#)

Set the security level

You can set the security level of the HP All-in-One to either **Low** or **High**. The default security setting is **Low**. Low level security does not require authentication.

- **Low:** does not support authentication. No passkey is required and any Bluetooth device within range can print to the HP All-in-One. This is the default security setting.
- **High:** supports authentication. You will need to enter a passkey before printing to the HP All-in-One.



NOTE: The HP All-in-One ships with a predefined passkey that is set to four zeroes "0000".

To set the product to require passkey authentication

1. Press **Setup**.



2. Press the down arrow button until **Bluetooth** is highlighted, and then press **OK**.
3. Press the down arrow button until **Passkey** is highlighted, and then press **OK**.
4. Use the visual keyboard to enter a new passkey.



NOTE: The passkey must be 1 to 4 characters long, and can only consist of numbers.

5. When you have finished entering your passkey, press **OK** to view the **Bluetooth** menu.
6. Press the down arrow button until **Security Level** is highlighted, and then press **OK**.
7. Press **OK** to select **High**.
High level security requires authentication.
Passkey authentication is now set for the product.

Related topics

[“Enter text using the visual keyboard” on page 14](#)

Set the HP All-in-One to be invisible to Bluetooth devices

You can set the HP All-in-One to be either **Visible to all** Bluetooth devices (public) or **Not visible** to any (private).

- **Visible to all:** This is the default accessibility level. Any Bluetooth device within range can print to the HP All-in-One.
- **Not visible:** Only Bluetooth devices that have stored the device address of the HP All-in-One can print to it.

To set the product to be Not visible

1. Press **Setup**.



2. Press the down arrow button until **Bluetooth** is highlighted, and then press **OK**.
3. Press the down arrow button until **Visibility** is highlighted, and then press **OK**.
4. Press the down arrow button to select **Not visible**, and then press **OK**.
The product is inaccessible to Bluetooth devices that have not stored its device address.

Reset Bluetooth settings on the HP All-in-One

You can reset all of the Bluetooth settings on the HP All-in-One to the factory defaults.

 **NOTE:** Only select **Reset Bluetooth** if you want all of the HP All-in-One Bluetooth settings returned to factory defaults.

To reset the Bluetooth settings

1. Press **Setup**.



2. Press the down arrow button until **Bluetooth** is highlighted, then press **OK**.
3. Press the down arrow button until **Reset Bluetooth** is highlighted, then press **OK**.

5 How do I?

This section contains links to commonly performed tasks, such as printing photos, scanning, and making copies.

- [“How do I print up to 13 x 18 cm \(5 x 7 inch\) borderless photos from a memory card?”](#) on page 72
- [“How do I make reprints of a photo in a variety of sizes?”](#) on page 93
- [“How do I make a black-and-white or color copy of a document?”](#) on page 85
- [“How do I print photos larger than 13 x 18 cm \(5 x 7 inch\) from a memory card?”](#) on page 72
- [“How do I save photos to my computer?”](#) on page 74
- [“How do I scan a photo or document to the computer?”](#) on page 81
- [“How do I print on both sides of the paper?”](#) on page 62
- [“How do I print custom labels on printable CD/DVDs?”](#) on page 61

6 Load originals and load paper

You can load many different types and sizes of paper in the HP All-in-One, including letter or A4 paper, photo paper, transparencies, and envelopes. In addition, the HP All-in-One enables you to load and print directly on the surface of specially coated CDs and DVDs.

By default, the HP All-in-One is set to detect the size and type of paper you load in the input tray automatically and then adjust its settings to generate the highest quality output for that paper. If you are using special papers, such as photo paper, transparency film, envelopes, or labels, or if you experience poor print quality using the automatic setting, you can manually set the paper size and type for print and copy jobs.

This section contains the following topics:

- [Load originals](#)
- [Choose papers for printing and copying](#)
- [Load paper](#)
- [Load a CD/DVD](#)
- [Avoid paper jams](#)

Load originals

You can copy or scan up to letter- or A4-size originals by loading them on the glass.

To load an original on the glass

1. Lift the lid to the open position.



2. Load your original print side down on the right front corner of the glass.

 **TIP:** For more help on loading an original, refer to the engraved guides along the edge of the glass.

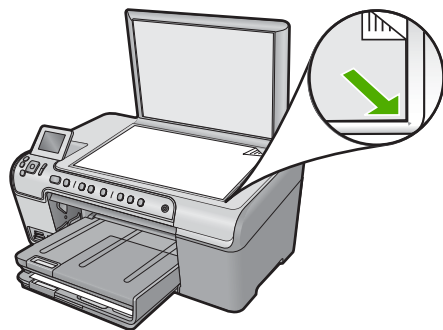

3. Close the lid.

Choose papers for printing and copying

You can use different types and sizes of paper in the HP All-in-One. Review the following recommendations to get the best printing and copying quality. Whenever you change paper types or sizes, remember to change those settings.

This section contains the following topics:

- [Recommended papers for printing and copying](#)
- [Recommended papers and media for printing only](#)
- [Papers to avoid](#)

Recommended papers for printing and copying

If you want the best print quality, HP recommends using HP papers that are specifically designed for the type of project you are printing. If you are printing photos, for example, load HP Premium or HP Premium Plus photo paper in the input tray.

The following is a list of HP papers you can use for copying and printing. Depending on your country/region, some of these papers might not be available.

HP Premium Plus Photo Paper

HP Premium Plus Photo Papers are the best HP photo paper, with image quality and fade resistance superior to store-processed photos. They are ideal for printing your high-resolution images for framing or including in a photo album. These papers are available in several sizes, including 10 x 15 cm (4 x 6 inch) (with or without tabs), 13 x 18 cm (5 x 7 inch), A4, and 8.5 x 11 inch.

HP Premium Photo Paper

HP Premium Photo Papers are high-quality, glossy-finish or soft gloss-finish photo papers. They look and feel like store-processed photos and can be mounted under glass or in an album. These papers are available in several sizes, including 10 x 15 cm (4 x 6 inch) (with or without tabs), A4, and 8.5 x 11 inch sizes for printing or copying photos from the product.

HP Advanced Photo Paper or HP Photo Paper

HP Advanced Photo Paper or HP Photo Paper is a sturdy, glossy photo paper that features an instant-dry finish for easy handling without smudging. It resists water, smears,

fingerprints, and humidity. Your prints have a look and feel comparable to a store-processed photo. It is available in several sizes, including A4, 8.5 x 11 inch, 10 x 15 cm (4 x 6 inch) (with or without tabs), and 13 x 18 cm (5 x 7 inch). HP Advanced Photo Paper is marked on the nonprinting corners with the following symbol:



HP Premium Inkjet Transparency Film

HP Premium Inkjet Transparency Film make your color presentations vivid and even more impressive. This film is easy to use and handle and dries quickly without smudging.

HP Premium Inkjet Paper

HP Premium Inkjet Paper is the ultimate coated paper for high-resolution usage. A smooth, matte finish makes it ideal for your highest-quality documents.

HP Bright White Inkjet Paper

HP Bright White Inkjet Paper delivers high-contrast colors and sharp text. It is opaque enough for two-sided color usage with no show-through, which makes it ideal for newsletters, reports, and flyers.

HP All-in-One Paper or HP Printing Paper

- HP All-in-One Paper is specifically designed for HP All-in-One products. It has an extra bright blue-white shade that produces sharper text and richer colors than ordinary multifunction papers.
- HP Printing Paper is a high-quality multifunction paper. It produces documents that look and feel more substantial than documents printed on standard multipurpose or copy paper.

To order HP papers and other supplies, go to www.hp.com/buy/supplies. If prompted, choose your country/region, follow the prompts to select your product, and then click one of the shopping links on the page.

 **NOTE:** At this time, some portions of the HP Web site are available in English only.

Recommended papers and media for printing only

Certain papers are supported only when you start the print job from your computer. The following list provides information about these papers.

If you want the best print quality, HP recommends using HP papers. Using paper that is too thin or too thick, paper that has a slick texture, or paper that stretches easily can cause paper jams. Using paper that has a heavy texture or does not accept ink can cause printed images to smear, bleed, or not fill in completely.

Depending on your country/region, some of these papers might not be available.

HP Inkjet-Printable CD/DVD Discs

HP Inkjet-Printable CD and DVD optical discs are offered in both white and silver matte finishes. Personalize CDs and DVDs with titles, graphics, or photos by printing directly on the discs.

HP Iron-On Transfers

HP Iron-On Transfers (for color fabrics or for light or white fabrics) are the ideal solution for creating custom T-shirts from your digital photos.

HP Photo Greeting Cards, HP Premium Photo Cards, and HP Note Cards

HP Photo Greeting Cards, Glossy or Matte, HP Premium Photo Cards, and HP Note Cards enable you to make your own greeting cards.

HP Brochure & Flyer Paper

HP Brochure & Flyer Paper (Gloss or Matte) is glossy-coated or matte-coated on both sides for two-sided use. They are the perfect choice for near-photographic reproductions and business graphics for report covers, special presentations, brochures, mailers, and calendars.

HP Premium Presentation Paper

HP Premium Presentation Paper gives your presentation a quality look and feel.

To order HP papers and other supplies, go to www.hp.com/buy/supplies. If prompted, choose your country/region, follow the prompts to select your product, and then click one of the shopping links on the page.



NOTE: At this time, some portions of the HP Web site are available in English only.

Papers to avoid

Using paper that is too thin or too thick, paper that has a slick texture, or paper that stretches easily can cause paper jams. Using paper that has a heavy texture or does not accept ink can cause printed images to smear, bleed, or not fill in completely.

Papers to avoid for all print and copy jobs

- Any size paper other than those listed in the printer software.
- Paper with cutouts or perforations (unless specifically designed for use with HP inkjet products).
- Highly textured stock, such as linen. It might not print evenly, and the ink can bleed into these papers.
- Extremely smooth, shiny, or coated papers not specifically designed for the product. They can jam the product or repel the ink.
- Multi-part forms, such as duplicate and triplicate forms. They can wrinkle or get stuck, and the ink is more likely to smear.
- Envelopes with clasps or windows. They can get stuck in the rollers and cause paper jams.
- Banner paper.

Additional papers to avoid when copying

- Envelopes.
- Transparency film other than HP Premium Inkjet Transparency Film.
- Iron-On Transfers.
- Greeting card paper.

Load paper

This section describes the procedure for loading different types and sizes of paper into the HP All-in-One for your copies or printouts.

💡 **TIP:** To help prevent rips, wrinkles, and curled or bent edges, store all paper flat in a resealable bag. If the paper is not stored properly, extreme changes in temperature and humidity might result in curled paper that does not work well in the HP All-in-One.

This section contains the following topics:

- [Load full-size paper or small-size photo paper](#)
- [Load postcards, Hagaki, or index cards](#)
- [Load envelopes](#)
- [Load other types of paper](#)

Load full-size paper or small-size photo paper

You can load many types and sizes of paper into the input trays of the HP All-in-One.

💡 **TIP:** Tap a stack of paper on a flat surface to align the edges. Make sure all the paper in the stack is the same size and type and free of rips, dust, wrinkles, and curled or bent edges.

To load full-size paper

1. Raise and hold the output tray in the open position.

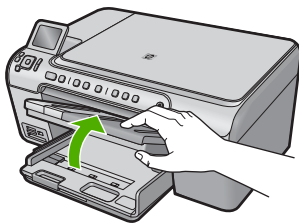

- Slide the paper-width guide to its outermost position.

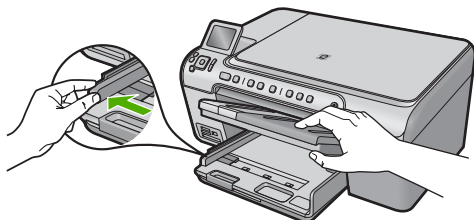

- Insert the stack of paper into the main input tray with the short edge forward and the print side down. Slide the stack of paper forward until it stops.

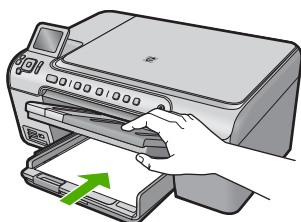

-
- ⚠ **CAUTION:** Make sure that the product is idle and silent when you load paper into the main input tray. If the product is servicing the print cartridges or otherwise engaged in a task, the paper stop inside the product might not be in place. You could push the paper too far forward, causing the product to eject blank pages.

- 💡 **TIP:** If you are using letterhead, insert the top of the page first with the print side down.
-

- Slide the paper-width guide inward until it stops at the edge of the paper. Do not overload the main input tray; make sure the stack of paper fits within the main input tray and is no higher than the top of the paper-width guide.

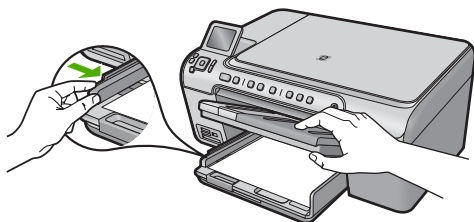

5. Lower the output tray. Pull the tray extender towards you, as far as it will go. Flip the paper catch at the end of the tray extender to open the extender the rest of the way.

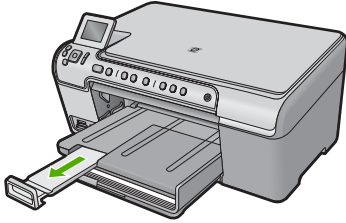

 **NOTE:** When you use legal-size paper, leave the tray extender closed.

To load up to 13 x 18 cm (5 x 7 inch) photo paper in the photo tray

1. Raise the photo tray lid.

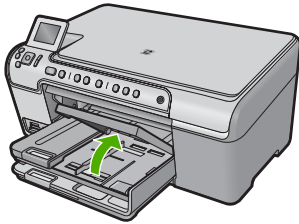

2. Slide the paper-width guide to its outermost position.

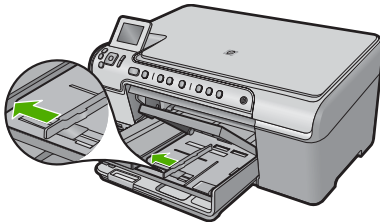

3. Insert the stack of photo paper into the photo tray with the short edge forward and the print side down. Slide the stack of photo paper forward until it stops.
If the photo paper you are using has perforated tabs, load the photo paper so that the tabs are closest to you.

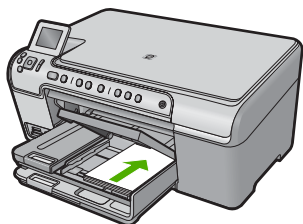

4. Slide the paper-width guide inward until it stops at the edge of the paper.
Do not overload the photo tray; make sure the stack of photo paper fits within the photo tray and is no higher than the top of the paper-width guide.

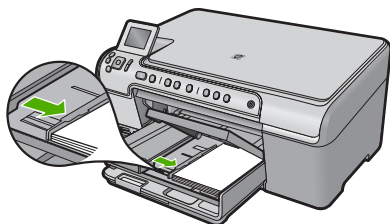

5. Lower the photo tray lid.

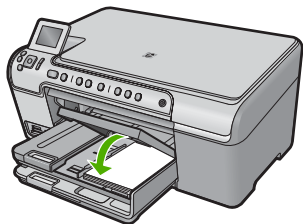

Load postcards, Hagaki, or index cards

You can load postcards, Hagaki, and index cards in the photo tray.

To load postcards, Hagaki, or index cards in the photo tray

1. Raise the photo tray lid.

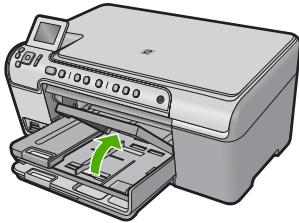

2. Slide the paper-width guide to its outermost position.

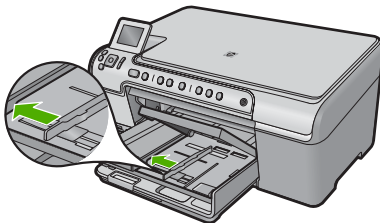

3. Insert the stack of cards into the photo tray with the short edge forward and the print side down. Slide the stack forward until it stops.

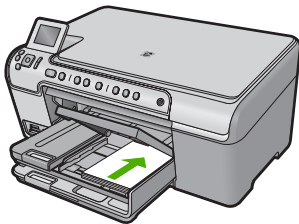

4. Slide the paper-width guide inward against the stack of cards until it stops. Do not overload the photo tray; make sure the stack of cards fits within the photo tray and is no higher than the top of the paper-width guide.

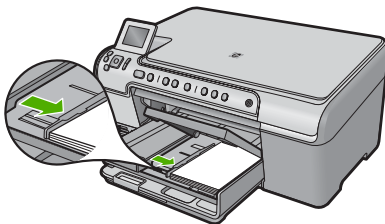

5. Lower the photo tray lid.

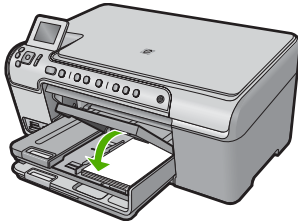

Load envelopes

You can load one or more envelopes into the main input tray of the HP All-in-One. Do not use shiny or embossed envelopes or envelopes that have clasps or windows.

 **NOTE:** For specific details on how to format text for printing on envelopes, consult the help files in your word processing software. For best results, consider using a label for the return address on envelopes.

To load envelopes

1. Raise and hold the output tray in the open position.

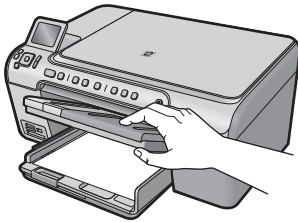

2. Remove all paper from the main input tray.

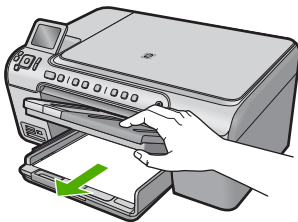

3. Slide the paper-width guide to its outermost position.

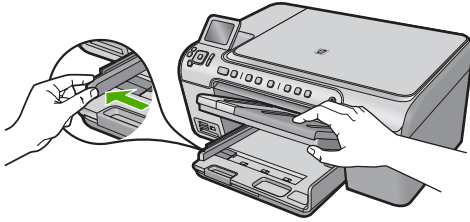

4. Insert one or more envelopes into the far-right side of the main input tray, with the envelope flaps on the left and facing up. Slide the stack of envelopes forward until it stops.

 **TIP:** To avoid paper jams, tuck the flap inside each envelope.

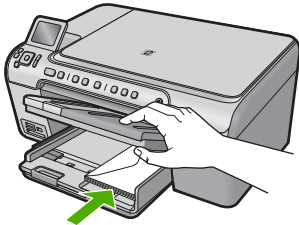

5. Slide the paper-width guide inward against the stack of envelopes until it stops. Do not overload the main input tray; make sure the stack of envelopes fits within the main input tray and is not higher than the top of the paper-width guide.

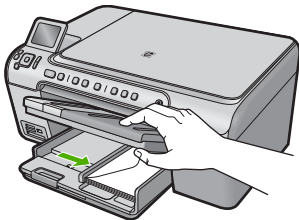

- Lower the output tray.

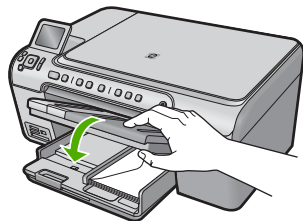

Related topics

[“Print a group of addresses on labels or envelopes” on page 67](#)

Load other types of paper

The following types of paper are designed for special projects. Create your project in the HP Photosmart Software or another application, set the paper type and size, and then print.

HP Premium Inkjet Transparency Film

- ▲ Insert the film so that the white transparency strip (with arrows and the HP logo) is on top and is going into the input tray first.

 **NOTE:** The HP All-in-One cannot automatically detect the paper type. For best results, set the paper type to transparency film in the software before printing onto transparency film.

HP Iron-On Transfers

1. Flatten the transfer sheet completely before using it; do not load curled sheets.

 **TIP:** To prevent curling, keep transfer sheets sealed in the original package until you are ready to use them.

2. Locate the blue stripe on the nonprinting side of the transfer paper and then manually feed one sheet at a time into the input tray with the blue stripe facing up.

HP Greeting Cards, HP Photo Greeting Cards, or HP Textured Greeting Cards

- ▲ Insert a small stack of HP greeting card paper into the input tray with the print side down; slide the stack of cards forward until it stops.

 **TIP:** Make sure the area on which you want to print is inserted first, print side down in the input tray.

Related topics

- [“Set the paper size” on page 52](#)
- [“Set the paper type for printing” on page 53](#)
- [“Print on transparencies” on page 67](#)

- [“Reverse an image for iron-on transfers”](#) on page 66
- [“Print a group of addresses on labels or envelopes”](#) on page 67

Load a CD/DVD

In addition to printing on paper, the HP All-in-One enables you to print directly on the surface of specially coated CDs and DVDs for print jobs started from a connected computer. You can design and create a custom label for your CD or DVD using the software that came with the HP All-in-One. You can then print the label on your printable CD or DVD media.

 **TIP:** It is recommended that you write your data to the CD or DVD before printing the label on it.

 **NOTE:** The HP All-in-One does not support a CD/DVD print job started from the control panel. You must use the software that came with the HP All-in-One to print on a CD/DVD. For more information, see the software help.

To load a regular-size (120 mm) CD/DVD on the CD/DVD tray

1. If the product is placed close to a wall, move it at least 7.5 cm (3 inches) away from the wall.
2. Carefully remove the CD/DVD holder from the storage area below the main paper tray.

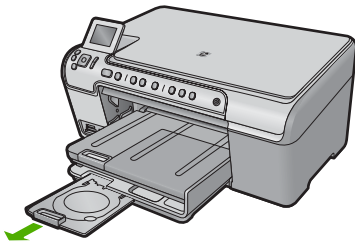

3. Securely snap the inkjet printable media onto the CD/DVD holder with the printable side up.

 **NOTE:** The CD/DVD should be placed on the ring at the end of the holder with the arrows.

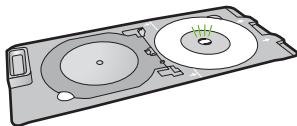

4. Lower the CD/DVD tray.
The CD/DVD tray is located just below the control panel. When in its lowered position, the CD/DVD tray sits on top of the output tray.

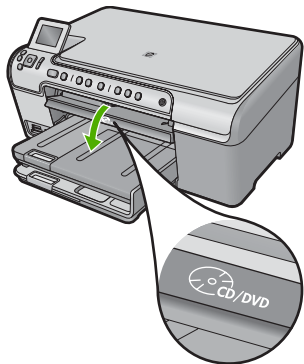

5. Push the CD/DVD holder into the product until the green lines on the CD/DVD holder line up with the green lines on the CD/DVD tray, and then press **OK**.

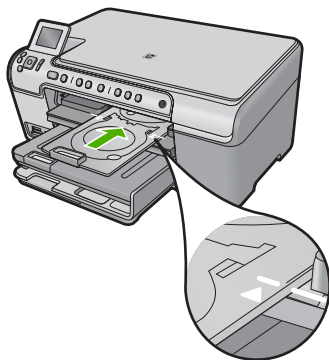

 **NOTE:** The product pulls the CD/DVD holder while printing on the media.

6. After printing, make sure you insert the CD/DVD holder back into the storage area.

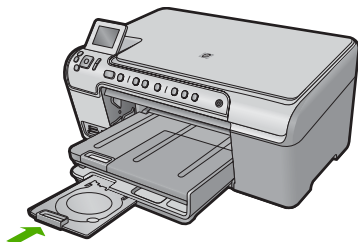

To load a small-size (80 mm) CD/DVD on the CD/DVD tray

1. If the product is placed close to a wall, move it at least 7.5 cm (3 inches) away from the wall.
2. Carefully remove the CD/DVD holder from the storage area below the main paper tray.

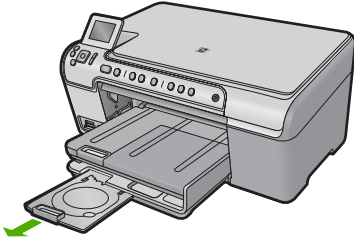

3. Securely snap the inkjet printable media onto the CD/DVD holder with the printable side up.



NOTE: The CD/DVD should be placed on the ring at the end of the holder with the arrows.

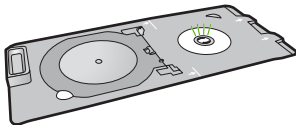

4. Flip the CD/DVD holder ring over the CD/DVD.

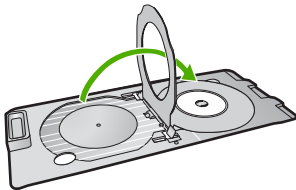

5. Lower the CD/DVD tray.

The CD/DVD tray is located just below the control panel. When in its lowered position, the CD/DVD tray sits on top of the output tray.

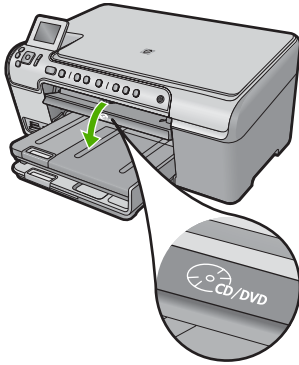

6. Push the CD/DVD holder into the product until the green lines on the CD/DVD holder line up to the green lines on the CD/DVD tray.

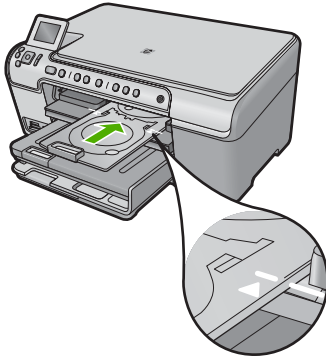

 **NOTE:** The product pulls the CD/DVD holder while printing on the media.

7. After printing, make sure you insert the CD/DVD holder back into the storage area.

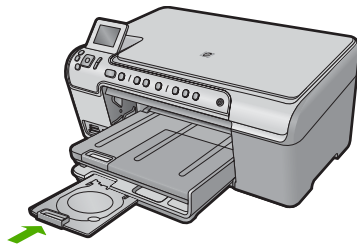

Avoid paper jams

To help avoid paper jams, follow these guidelines.

- Remove printed papers from the output tray frequently.
- Prevent curled or wrinkled photo paper by storing all unused photo paper flat in a resealable bag.
- Ensure that paper loaded in the input tray lays flat and the edges are not bent or torn.
- If you are printing labels, ensure that the label sheets are no more than two years old. Labels on older sheets might peel off when the paper is pulled through the product, and cause paper jams.
- Do not combine different paper types and paper sizes in the input tray; the entire stack of paper in the input tray must be the same size and type.
- Adjust the paper-width guide in the input tray to fit snugly against all paper. Make sure the paper-width guide does not bend the paper in the input tray.
- Do not force paper too far forward in the input tray.
- Use paper types that are recommended for the product.

Related topics

[“Clear paper jams” on page 131](#)

7 Print from your computer

The HP All-in-One can be used with any software application that allows printing. You can print a range of projects, such as borderless images, newsletters, greeting cards, iron-on transfers, and posters.

This section contains the following topics:

- [Print from a software application](#)
- [Make the HP All-in-One the default printer](#)
- [Change the print settings for the current job](#)
- [Change the default print settings](#)
- [Printing shortcuts](#)
- [Perform special print jobs](#)
- [Stop a print job](#)

Print from a software application

Most print settings are automatically handled by the software application. You need to change the settings manually only when you change print quality, print on specific types of paper or transparency film, or use special features.

To print from a software application

1. Make sure you have paper loaded in the input tray.
2. On the **File** menu in your software application, click **Print**.
3. Make sure the product is the selected printer.
4. If you need to change settings, click the button that opens the **Properties** dialog box. Depending on your software application, this button might be called **Properties**, **Options**, **Printer Setup**, **Printer**, or **Preferences**.



NOTE: When printing a photo, you must select options for the specific photo paper and photo enhancement.

5. Select the appropriate options for your print job by using the features available in the **Advanced**, **Printing Shortcuts**, **Features**, and **Color** tabs.



TIP: You can easily select the appropriate options for your print job by choosing one of the predefined print tasks on the **Printing Shortcuts** tab. Click a type of print task in the **Printing Shortcuts** list. The default settings for that type of print task are set and summarized on the **Printing Shortcuts** tab. If necessary, you can adjust the settings here and save your custom settings as a new printing shortcut. To save a custom printing shortcut, select the shortcut and click **Save As**. To delete a shortcut, select the shortcut and click **Delete**.

6. Click **OK** to close the **Properties** dialog box.
7. Click **Print** or **OK** to begin printing.

Make the HP All-in-One the default printer

You can set the HP All-in-One as the default printer to use from all software applications. This means that the HP All-in-One is automatically selected in the printer list when you select **Print** from the **File** menu in a software application. The default printer is automatically selected when you click the **Print** button in the toolbar of most software applications. For more information, see the Windows Help.

Change the print settings for the current job

You can customize the print settings of the HP All-in-One to handle nearly any print task.

This section contains the following topics:

- [Set the paper size](#)
- [Set the paper type for printing](#)
- [View the print resolution](#)
- [Change the print speed or quality](#)
- [Change the page orientation](#)
- [Scale the document size](#)
- [Change the saturation, brightness, or color tone](#)
- [Preview your print job](#)

Set the paper size

The **Size** setting helps the HP All-in-One determine the printable area on the page. Some of the paper size choices have a borderless equivalent, which allows you to print to the top, bottom, and side edges of the paper.

Usually, you set the paper size in the software application you used to create your document or project. However, if you are using custom-size paper, or if you cannot set the paper size from your software application, you can change the paper size in the **Properties** dialog box before printing.

To set the paper size

1. Make sure you have paper loaded in the input tray.
2. On the **File** menu in your software application, click **Print**.
3. Make sure the product is the selected printer.
4. Click the button that opens the **Properties** dialog box. Depending on your software application, this button might be called **Properties**, **Options**, **Printer Setup**, **Printer**, or **Preferences**.
5. Click the **Features** tab.
6. In the **Resizing Options** area, from the **Size** drop-down list, select **More**.
7. Select the appropriate paper size, and then click **OK**.

The following table lists the suggested paper size settings for the different types of paper you can load in the input tray. Make sure to look at the long list of choices in

the **Size** list to see if a defined paper size already exists for the type of paper you are using.

Paper type	Suggested paper size settings
Copier, multi-purpose, or plain papers	Letter or A4
Envelopes	Appropriate listed envelope size
Greeting-card papers	Letter or A4
Index cards	Appropriate listed card size (if listed sizes are not appropriate, you can specify a custom paper size)
Inkjet papers	Letter or A4
Iron-on T-shirt transfers	Letter or A4
Labels	Letter or A4
Legal	Legal
Letterhead	Letter or A4
Panorama photo paper	Appropriate listed panorama size (if listed sizes are not appropriate, you can specify a custom paper size)
Photo papers	10 x 15 cm (4 x 6 inch) (with or without tab), up to 13 x 18 cm (5 x 7 inch) (with or without tab), letter, A4, or an appropriate listed size
Transparency films	Letter or A4
Custom-size papers	Custom paper size

Set the paper type for printing

If you print on special papers, such as photo paper, transparency film, envelopes, or labels, or if you experience poor print quality, you can set the paper type manually.

To set the paper type for printing

1. Make sure you have paper loaded in the input tray.
2. On the **File** menu in your software application, click **Print**.
3. Make sure the product is the selected printer.
4. Click the button that opens the **Properties** dialog box.
Depending on your software application, this button might be called **Properties**, **Options**, **Printer Setup**, **Printer**, or **Preferences**.
5. Click the **Features** tab.
6. In the **Basic Options** area, from the **Paper Type** drop-down list, select **More**.
7. Select the type of paper that you have loaded, and then click **OK**.

View the print resolution

The printer software displays the print resolution in dots per inch (dpi). The dpi varies according to the paper type and print quality that you select in the printer software.

To view the print resolution

1. Make sure you have paper loaded in the input tray.
2. On the **File** menu in your software application, click **Print**.
3. Make sure the product is the selected printer.
4. Click the button that opens the **Properties** dialog box.
Depending on your software application, this button might be called **Properties**, **Options**, **Printer Setup**, **Printer**, or **Preferences**.
5. Click the **Features** tab.
6. In the **Paper Type** drop-down list, select the type of paper that you have loaded.
7. In the **Print Quality** drop-down list, select the appropriate print quality setting for your project.
8. Click the **Resolution** button to view the print resolution dpi for the paper type and print quality combination you selected.

Change the print speed or quality

The HP All-in-One automatically chooses a print quality and speed setting depending on the paper type setting you select. You can also change the print quality setting to customize the speed and quality of the print process.

To select a print speed or quality

1. Make sure you have paper loaded in the input tray.
2. On the **File** menu in your software application, click **Print**.
3. Make sure the product is the selected printer.
4. Click the button that opens the **Properties** dialog box.
Depending on your software application, this button might be called **Properties**, **Options**, **Printer Setup**, **Printer**, or **Preferences**.
5. Click the **Features** tab.
6. In the **Paper Type** drop-down list, select the type of paper that you have loaded.
7. In the **Print Quality** drop-down list, select the appropriate quality setting for your project.



NOTE: To find out what dpi the product will print based on the paper type and print quality settings you selected, click **Resolution**.

Change the page orientation

The page orientation setting allows you to print your document vertically or horizontally on the page.

Usually, you set the page orientation in the software application you used to create your document or project. However, if you are using custom-size or special HP paper, or if you cannot set the page orientation from your software application, you can change the page orientation in the **Properties** dialog box before printing.

To change the page orientation

1. Make sure you have paper loaded in the input tray.
2. On the **File** menu in your software application, click **Print**.

3. Make sure the product is the selected printer.
4. Click the button that opens the **Properties** dialog box.
Depending on your software application, this button might be called **Properties**, **Options**, **Printer Setup**, **Printer**, or **Preferences**.
5. Click the **Features** tab.
6. In the **Basic Options** area, do one of the following:
 - Click **Portrait** to print the document vertically on the page.
 - Click **Landscape** to print the document horizontally on the page.

Scale the document size

The HP All-in-One allows you to print the document at a different size than the original.

To scale the document size

1. Make sure you have paper loaded in the input tray.
2. On the **File** menu in your software application, click **Print**.
3. Make sure the product is the selected printer.
4. Click the button that opens the **Properties** dialog box.
Depending on your software application, this button might be called **Properties**, **Options**, **Printer Setup**, **Printer**, or **Preferences**.
5. Click the **Features** tab.
6. In the **Resizing options** area, click **Scale to paper size**, and then click the appropriate paper size from the drop-down list.

Change the saturation, brightness, or color tone

You can change the intensity of colors and the level of darkness in your printout by adjusting the **Saturation**, **Brightness**, or **Color Tone** options.

To change the saturation, brightness, or color tone

1. Make sure you have paper loaded in the input tray.
2. On the **File** menu in your software application, click **Print**.
3. Make sure the product is the selected printer.
4. Click the button that opens the **Properties** dialog box.
Depending on your software application, this button might be called **Properties**, **Options**, **Printer Setup**, **Printer**, or **Preferences**.
5. Click the **Color** tab.
6. Click the **More Color Options** button.
7. Move the sliders to adjust the **Saturation**, **Brightness**, or **Color Tone**.
 - **Brightness** indicates the lightness or darkness of the printed document.
 - **Saturation** is the relative purity of printed colors.
 - **Color Tone** affects the perceived warmth or coolness of printed colors, by adding more orange or blue tones, respectively, to your image.

Preview your print job

You can preview your print job before sending it to the HP All-in-One. This helps to prevent wasting paper and ink on projects that do not print as expected.

To preview your print job

1. Make sure you have paper loaded in the input tray.
2. On the **File** menu in your software application, click **Print**.
3. Make sure the product is the selected printer.
4. Click the button that opens the **Properties** dialog box.
Depending on your software application, this button might be called **Properties**, **Options**, **Printer Setup**, **Printer**, or **Preferences**.
5. Select the print settings appropriate for your project on each of the tabs in the dialog box.
6. Click the **Features** tab.
7. Select the **Show Preview Before Printing** check box.
8. Click **OK**, and then click **Print** or **OK** in the **Print** dialog box.
Your print job displays in the preview window.
9. In the **HP preview** window, do one of the following:
 - To print, click **Start Printing**.
 - To cancel, click **Cancel Printing**.

Change the default print settings

If there are settings that you frequently use for printing, you might want to make them the default print settings so they are already set when you open the **Print** dialog box from within your software application.

To change the default print settings

1. In the HP Solution Center, click **Settings**, point to **Print Settings**, and then click **Printer Settings**.
2. Make changes to the print settings, and click **OK**.

Printing shortcuts

Use printing shortcuts to print with print settings that you use often. The printer software has several specially designed printing shortcuts that are available in the Printing Shortcuts list.

 **NOTE:** When you select a printing shortcut the appropriate printing options are automatically displayed. You can leave them as is, change them, or create your own shortcuts for commonly used tasks.

Use the Printing Shortcuts tab for the following print tasks:

- **General Everyday Printing:** Print documents quickly.
- **Photo Printing–Borderless:** Print to the top, bottom, and side edges of 10 x 15 cm (4 x 6 inch) and 13 x 18 cm (5 x 7 inch) HP Photo Papers.
- **Photo Printing–With White Borders:** Print a photo with a white border around the edges.
- **Fast/Economical Printing:** Produce draft-quality printouts quickly.

- **Presentation Printing:** Print high-quality documents, including letters and transparencies.
- **Two-sided (Duplex) Printing:** Print two-sided pages manually.

This section contains the following topics:

- [Create printing shortcuts](#)
- [Delete printing shortcuts](#)

Related topics

- [“Print a borderless image” on page 58](#)
- [“Print photos” on page 72](#)
- [“Print on transparencies” on page 67](#)
- [“Print on both sides of the page” on page 62](#)

Create printing shortcuts

In addition to the printing shortcuts that are available in the **Printing Shortcuts** list, you can create your own printing shortcuts.

If you frequently print on transparency film, for example, you can create a printing shortcut by selecting the **Presentation Printing** shortcut, changing the paper type to **HP Premium Inkjet Transparency Film**, and then saving the modified shortcut under a new name; for example, **Transparency Presentations**. After creating the printing shortcut, simply select it when printing on transparency film rather than changing the print settings each time.

To create a printing shortcut

1. On the **File** menu in your software application, click **Print**.
2. Make sure the product is the selected printer.
3. Click the button that opens the **Properties** dialog box.
Depending on your software application, this button might be called **Properties**, **Options**, **Printer Setup**, **Printer**, or **Preferences**.
4. Click the **Printing Shortcuts** tab.
5. In the **Printing Shortcuts** list, click a printing shortcut.
The print settings for the selected printing shortcut are displayed.
6. Change the print settings to those you want in the new printing shortcut.
7. Click **Save as** and type a name for the new printing shortcut, and then click **Save**.
The printing shortcut is added to the list.

Delete printing shortcuts

You might want to delete printing shortcuts that you no longer use.

To delete a printing shortcut

1. On the **File** menu in your software application, click **Print**.
2. Make sure the product is the selected printer.

3. Click the button that opens the **Properties** dialog box.
Depending on your software application, this button might be called **Properties**, **Options**, **Printer Setup**, **Printer**, or **Preferences**.
4. Click the **Printing Shortcuts** tab.
5. In the **Printing Shortcuts** list, click the printing shortcut that you want to delete.
6. Click **Delete**.
The printing shortcut is removed from the list.



NOTE: Only the shortcuts that you have created can be deleted. The original HP shortcuts cannot be deleted.

Perform special print jobs

In addition to supporting standard print jobs, the HP All-in-One can perform special jobs such as printing borderless images, iron-on transfers, and posters.

This section contains the following topics:

- [Print a borderless image](#)
- [Print a photo on photo paper](#)
- [Print using Maximum dpi](#)
- [Print onto a CD/DVD](#)
- [Print on both sides of the page](#)
- [Print a multiple-page document as a booklet](#)
- [Print multiple pages on a single sheet](#)
- [Print a multiple-page document in reverse order](#)
- [Reverse an image for iron-on transfers](#)
- [Print on transparencies](#)
- [Print a group of addresses on labels or envelopes](#)
- [Print a poster](#)
- [Print a Web page](#)

Print a borderless image

Borderless printing lets you print to the top, bottom, and side edges of up to 13 x 18 cm (5 x 7 inch) photo paper.



TIP: For the best results, use HP Advanced Photo Paper to print your photos.



To print a borderless image

1. Load up to 13 x 18 cm (5 x 7 inch) paper in the photo tray.
2. On the **File** menu in your software application, click **Print**.

3. Make sure the product is the selected printer.
4. Click the button that opens the **Properties** dialog box.
Depending on your software application, this button might be called **Properties**, **Options**, **Printer Setup**, **Printer**, or **Preferences**.
5. Click the **Features** tab.
6. In the **Size** list, click **More**, and then select the size of photo paper loaded in the photo tray.
If a borderless image can be printed on the specified size, the **Borderless printing** check box is enabled.
7. In the **Paper Type** drop-down list, click **More**, and then select the appropriate paper type.

 **NOTE:** You cannot print a borderless image if the paper type is set to **Plain paper** or to a type of paper other than a photo paper.

8. Select the **Borderless** check box if it is not already checked.
If the borderless paper size and paper type are not compatible, the product software displays an alert and allows you to select a different type or size.
9. Click **OK**, and then click **Print** or **OK** in the **Print** dialog box.

 **NOTE:** Do not leave unused photo paper in the input tray. The paper might start to curl, which could reduce the quality of your printout. Photo paper should be flat before printing.

Print a photo on photo paper

To achieve the best print quality, HP recommends using HP papers that are specifically designed for the type of project you are printing along with genuine HP ink. HP papers and HP ink are specifically designed to work well together to provide high-quality output.

For photo printing, HP recommends that you use HP Advanced Photo Paper with the HP All-in-One.

To print a photo on photo paper

1. Load up to 13 x 18 cm (5 x 7 inch) paper in the photo tray or full-size photo paper in the main input tray.

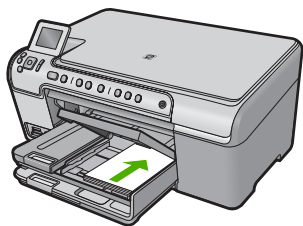

2. On the **File** menu in your software application, click **Print**.
3. Make sure the product is the selected printer.

4. Click the button that opens the **Properties** dialog box.
Depending on your software application, this button might be called **Properties**, **Options**, **Printer Setup**, **Printer**, or **Preferences**.
5. Click the **Features** tab.
6. In the **Basic Options** area, from the **Paper Type** drop-down list, select **More**. Then, select the appropriate photo paper type.
7. In the **Resizing Options** area, from the **Size** drop-down list, select **More**. Then, select the appropriate paper size.
If the paper size and paper type are not compatible, the printer software displays an alert and allows you to select a different type or size.
8. In the **Basic Options** area, select a high print quality, such as **Best**, from the **Print Quality** drop-down list.



NOTE: To achieve the highest dpi resolution, you can use the **Maximum dpi** setting with supported types of photo paper. If **Maximum dpi** is not listed in the Print quality drop-down list, you can enable it from the **Advanced** tab. For more information, see [“Print using Maximum dpi” on page 60](#).

9. In the **HP Real Life Technologies** area, click the **Photo fix** drop-down list and select from the following options:
 - **Off:** applies no **HP Real Life Technologies** to the image.
 - **Basic:** enhances low-resolution images; moderately adjusts image sharpness.
 - **Full:** automatically adjusts brightness, contrast, and sharpness; enhances low-resolution images; automatically removes red-eye coloring in the photo.



TIP: You can remove red-eye coloring in the photo when using the **Off** or **Basic** mode by selecting the **Remove red eye** check box.

10. Click **OK** to return to the **Properties** dialog box.
11. (Optional) If you want to print the photo in black and white, click the **Color** tab and select the **Print in grayscale** check box. From the drop-down list, select one of the following options:
 - **High Quality:** uses all the available colors to print your photo in grayscale. This creates smooth and natural shades of gray.
 - **Black Ink Only:** uses black ink to print your photo in grayscale. The gray shading is created by varying patterns of black dots, which might result in a grainy image.
12. Click **OK**, and then click **Print** or **OK** in the **Print** dialog box.



NOTE: Do not leave unused photo paper in the input tray. The paper might start to curl, which could reduce the quality of your printout. Photo paper should be flat before printing.

Print using Maximum dpi

Use maximum dpi mode to print high-quality, sharp images.

To get the most benefit from maximum dpi mode, use it to print high-quality images such as digital photographs. When you select the maximum dpi setting, the printer software displays the optimized dots per inch (dpi) that the HP All-in-One printer will print.

Printing in maximum dpi takes longer than printing with other settings and requires a large amount of disk space.

To print in Maximum dpi mode

1. Make sure you have paper loaded in the input tray.
2. On the **File** menu in your software application, click **Print**.
3. Make sure the product is the selected printer.
4. Click the button that opens the **Properties** dialog box.
Depending on your software application, this button might be called **Properties**, **Options**, **Printer Setup**, **Printer**, or **Preferences**.
5. Click the **Advanced** tab.
6. In the **Features** area, select the **Enable maximum dpi setting** check box.
7. Click the **Features** tab.
8. In the **Paper Type** drop-down list, click **More**, and then select the appropriate paper type.
9. In the **Print Quality** drop-down list, click **Maximum dpi**.

 **NOTE:** To find out what dpi the product will print based on the paper type and print quality settings you selected, click **Resolution**.

10. Select any other print settings that you want, and then click **OK**.

Print onto a CD/DVD

You can use the HP Photosmart Software to print directly onto the surface of an inkjet printable CD/DVD.

To print directly onto a CD/DVD

1. Use the software that came with the product to create and print a CD/DVD label.
2. When prompted, load a CD/DVD into the CD/DVD holder on the product.
3. Push the CD/DVD holder into the product until the green lines on the CD/DVD holder line up to the green lines on the CD/DVD tray.

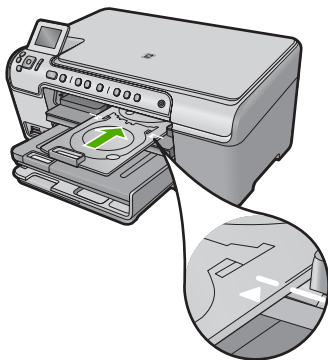

 **NOTE:** The product pulls the CD/DVD holder while printing on the media.

Related topics

[“Load a CD/DVD” on page 45](#)

Print on both sides of the page

You can print two-sided pages with the HP All-in-One manually. When printing two-sided pages, make sure to use paper that is thick enough so that images do not show through to the other side.

To print on both sides of the page

1. Load paper into the input tray.
2. On the **File** menu in your software application, click **Print**.
3. Make sure the product is the selected printer.
4. Click the button that opens the **Properties** dialog box.
Depending on your software application, this button might be called **Properties**, **Options**, **Printer Setup**, **Printer**, or **Preferences**.
5. Click the **Features** tab.
6. In the **Paper saving options** area, select **Manual** from the **Two-sided printing** drop-down list.
7. For binding, do one of the following:
 - For binding on the top like a notebook or calendar, select the **Flip Pages Up** check box.
This causes the odd and even pages of your document to print opposite of each other top-to-bottom. This ensures that the top of the page is always at the top of the sheet when you flip the pages up in your bound document.

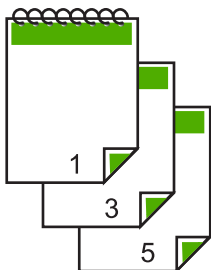

- For binding on the side like a book or magazine, click to clear the **Flip Pages Up** check box.
This causes the odd and even pages of your document to print opposite of each other left-to-right. This ensures that the top of the page is always at the top of the sheet when you turn the pages in your bound document.

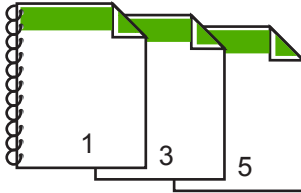

8. Click **OK**, and then click **Print** or **OK** in the **Print** dialog box.
The product begins printing. Wait until all the odd-numbered pages are printed before removing any of the printed pages from the output tray.
A dialog box displays instructions on the screen when it is time to process the second side of your job.
9. Click **Continue** when done.

Print a multiple-page document as a booklet

The HP All-in-One allows you to print your document as a small booklet, which you can fold and then staple together.

For best results, design your document to fit on a multiple of four pages, such as an 8, 12, or 16-page program for a child's school play or for a wedding.

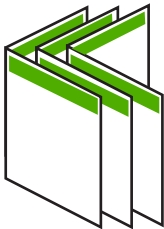

To print a multiple-page document as a booklet

1. Load paper into the input tray.
The paper should be thick enough so that the images do not show through to the other side.
2. On the **File** menu in your software application, click **Print**.
3. Make sure the product is the selected printer.
4. Click the button that opens the **Properties** dialog box.
Depending on your software application, this button might be called **Properties**, **Options**, **Printer Setup**, **Printer**, or **Preferences**.
5. Click the **Features** tab.

6. In the **Paper saving options** area, select **Manual** from the **Two-sided printing** drop-down list.
7. Select the binding edge from the **Booklet layout is** list, as appropriate for your language.
 - If your language reads left-to-right, click **Left edge binding**.
 - If your language reads right-to-left, click **Right edge binding**.

The **Pages per sheet** box is automatically set to two pages per sheet.

8. Click **OK**, and then click **Print** or **OK** in the **Print** dialog box.

The product begins printing.

A dialog box displays instructions on the screen when it is time to process the second side of your job. Do **not** click **Continue** in the dialog box until you have reloaded the paper as instructed in the following steps.

9. Wait until the product has stopped printing for several seconds before removing any of the printed pages from the output tray.

If you remove the pages while the document is still printing, the pages might get out of order.
10. Follow the instructions that appear on your screen for reloading the paper to print on the second side, and then click **Continue**.
11. When the entire document has finished printing, fold the stack of paper in half, so that the first page is on top, then staple the document along the crease.

 **TIP:** For best results, use a saddle stapler, or a heavy-duty stapler with a long reach to staple the booklet.

Figure 7-1 Left-edge binding for left-to-right languages

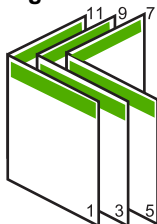
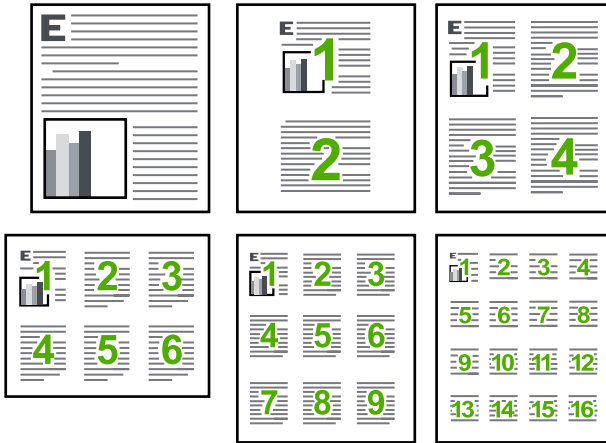

Figure 7-2 Right-edge binding for right-to-left languages



Print multiple pages on a single sheet

You can print up to 16 pages on a single sheet of paper.



To print multiple pages on a single sheet

1. Make sure you have paper loaded in the input tray.
2. On the **File** menu in your software application, click **Print**.
3. Make sure the product is the selected printer.
4. Click the button that opens the **Properties** dialog box. Depending on your software application, this button might be called **Properties**, **Options**, **Printer Setup**, **Printer**, or **Preferences**.
5. Click the **Features** tab.
6. In the **Pages per sheet** list, click **2**, **4**, **6**, **9**, or **16**.
7. If you want a border to appear around each page image printed on the sheet of paper, select the **Print page borders** check box.
8. In the **Page order** list, click an appropriate page order option. The sample output graphic is numbered to show how the pages will be ordered if you select each option.
9. Click **OK**, and then click **Print** or **OK** in the **Print** dialog box.

Print a multiple-page document in reverse order

Because of the way the paper feeds through the HP All-in-One, the first page that prints is print side up at the bottom of the stack. Usually this means you need to put the printed pages in the correct order.

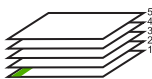

A better way is to print the document in reverse order so that the pages are stacked correctly.



 **TIP:** Set this option as a default setting so you do not have to remember to set it every time you print a multiple-page document.

To print a multiple-page document in reverse order

1. Make sure you have paper loaded in the input tray.
2. On the **File** menu in your software application, click **Print**.
3. Make sure the product is the selected printer.
4. Click the button that opens the **Properties** dialog box.
Depending on your software application, this button might be called **Properties**, **Options**, **Printer Setup**, **Printer**, or **Preferences**.
5. Click the **Advanced** tab.
6. In the **Layout Options** area, select **Front to Back** in the **Page Order** option.

 **NOTE:** If you set your document to print on both sides of the page, the **Front to Back** option is not available. Your document will automatically print in the correct order.

7. Click **OK**, and then click **Print** or **OK** in the **Print** dialog box.

 **NOTE:** When you are printing multiple copies, each set is printed completely before the next set is printed.

Reverse an image for iron-on transfers

This feature reverses an image so you can use it for iron-on transfers. This feature is also useful for transparencies when you want to make notations on the back of the transparency without scratching the original.

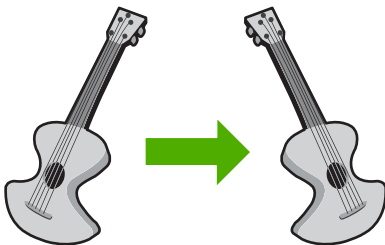

To reverse an image for iron-on transfers

1. On the **File** menu in your software application, click **Print**.
2. Make sure the product is the selected printer.

3. Click the button that opens the **Properties** dialog box.
Depending on your software application, this button might be called **Properties**, **Options**, **Printer Setup**, **Printer**, or **Preferences**.
4. Click the **Features** tab.
5. In the **Paper Type** drop-down list, click **More**, and then select **HP Iron-on Transfer** from the list.
6. If the selected size is not what you want, click an appropriate size in the **Size** list.
7. Click the **Advanced** tab.
8. In the **Features** area, select the **Mirror Image** check box.
9. Click **OK**, and then click **Print** or **OK** in the **Print** dialog box.

 **NOTE:** To prevent jams, manually feed the iron-on transfer sheets into the input tray one sheet at a time.

Print on transparencies

For the best results, HP recommends you use HP transparency products with the HP All-in-One.

To print on transparencies

1. Load the transparency into the input tray.
 2. On the **File** menu in your software application, click **Print**.
 3. Make sure the product is the selected printer.
 4. Click the button that opens the **Properties** dialog box.
Depending on your software application, this button might be called **Properties**, **Options**, **Printer Setup**, **Printer**, or **Preferences**.
 5. Click the **Features** tab.
 6. In the **Basic Options** area, from the **Paper Type** drop-down list, select **More**. Then select the appropriate paper type.
-
-  **TIP:** If you want to make notations on the back of the transparencies and erase them later without scratching the original, click the **Advanced** tab, and select the **Mirror Image** check box.
-
7. In the **Resizing Options** area, from the **Size** drop-down list, select **More**. Then, select an appropriate size.
 8. Click **OK**, and then click **Print** or **OK** in the **Print** dialog box.

 **NOTE:** The product automatically waits for transparencies to dry before releasing them. Ink dries slower on film than on plain paper. Make sure you allow enough time for the ink to dry before handling the transparency.

Print a group of addresses on labels or envelopes

With the HP All-in-One, you can print on a single envelope, a group of envelopes, or label sheets designed for inkjet printers.

To print a group of addresses on labels or envelopes

1. Print a test page on plain paper first.
2. Place the test page on top of the label sheet or envelope, and hold both up to the light. Check the spacing for each block of text. Make adjustments as needed.
3. Load the labels or envelopes into the main input tray.

△ **CAUTION:** Do not use envelopes with clasps or windows. They can get stuck in the rollers and cause paper jams.

4. Slide the paper-width guide inward against the stack of labels or envelopes until the guide stops.
5. If you are printing on envelopes, do the following:
 - a. Display the print settings, and click the **Features** tab.
 - b. In the **Resizing Options** area, click the appropriate envelope size in the **Size** list.
6. Click **OK**, and then click **Print** or **OK** in the **Print** dialog box.

Print a poster

You can create a poster by printing a document on multiple pages. The HP All-in-One prints dotted lines on some pages to indicate where to trim the pages before taping them together.

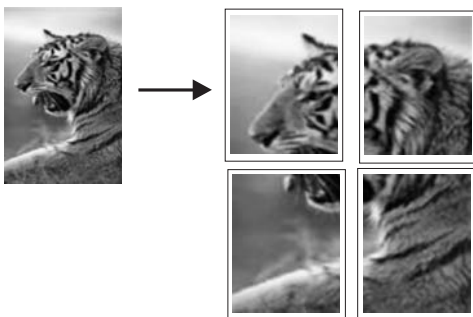

To print a poster

1. Make sure you have paper loaded in the input tray.
2. On the **File** menu in your software application, click **Print**.
3. Make sure the product is the selected printer.
4. Click the button that opens the **Properties** dialog box. Depending on your software application, this button might be called **Properties**, **Options**, **Printer Setup**, **Printer**, or **Preferences**.
5. Click the **Advanced** tab.
6. Expand **Document Options**, and then expand **Printer Features**.

7. In the **Poster Printing** drop-down list, click either **2x2 (4 sheets)**, **3x3 (9 sheets)**, **4x4 (16 sheets)**, or **5x5 (25 sheets)**.

This selection tells the product to enlarge your document so that it fits on 4, 9, 16, or 25 pages.

If your originals are of multiple pages, each of those pages will be printed on 4, 9, 16, or 25 pages. For example, if you have a one-page original and you select 3x3, you will get 9 pages; if you select 3x3 for a two-page original, 18 pages will print.

8. Click **OK**, and then click **Print** or **OK** in the **Print** dialog box.
9. After the poster has printed, trim the edges of the sheets and tape the sheets together.

Print a Web page

You can print a Web page from your Web browser on the HP All-in-One.

If you use Internet Explorer 6.0 or higher for Web browsing, you can use **HP Smart Web Printing** to ensure simple, predictable web printing with control over what you want and how you want it printed. You can access **HP Smart Web Printing** from the toolbar in Internet Explorer. For more information about **HP Smart Web Printing**, see the help file provided with it.

To print a Web page

1. Make sure you have paper loaded in the main input tray.
2. On the **File** menu in your Web browser, click **Print**.
The **Print** dialog box appears.
3. Make sure the product is the selected printer.
4. If your Web browser supports it, select the items on the Web page that you want to include in the printout.
For example, in Internet Explorer, click the **Options** tab to select options such as **As laid out on screen**, **Only the selected frame**, and **Print all linked documents**.
5. Click **Print** or **OK** to print the Web page.

 **TIP:** To print Web pages correctly, you might need to set your print orientation to **Landscape**.

Stop a print job

Although you can stop a print job from either the HP All-in-One or the computer, HP recommends you stop it from the HP All-in-One for best results.

To stop a print job from the product

- ▲ Press **Cancel**. If the print job does not stop, press **Cancel** again.
It can take a few moments for the print job to be cancelled.

To stop a print job from the computer

1. On the Windows taskbar, click **Start**, and then click **Control Panel**.
2. Click **Printers** (or double-click **Printers and Faxes**).

3. Double-click the product icon.

 **TIP:** You can also double-click the printer icon in the Windows taskbar.

4. Select the print job you want to cancel.
5. On the **Document** menu, click **Cancel Printing** or **Cancel**, or press the **Delete** key on your keyboard.

It can take a few moments for the print job to be cancelled.

8 Use the photo features

The HP All-in-One is equipped with memory card slots and a front USB port that enable you to print or edit photos from a memory card or storage device (such as a keychain drive, portable hard drive, or a digital camera in storage mode) without uploading your photos to a computer first. Additionally, if the HP All-in-One is connected to a computer with a USB cable, you can also transfer your photos to the computer to print, edit, or share.

You can print photos by connecting a PictBridge-compatible digital camera directly to the front USB port. When you print from a digital camera, the printer uses the settings that you selected on the camera. For more information, see the documentation that came with the camera.

This section contains the following topics:

- [Insert a memory card](#)
- [Print photos](#)
- [Create special projects from your photos](#)
- [Save photos to your computer](#)
- [Edit photos using the control panel](#)

Insert a memory card

The HP All-in-One supports memory cards and storage devices as described below. Each type of memory card can only be inserted in the appropriate slot for that card, and only one card or a storage device may be inserted at a time.

-
- △ **CAUTION:** Do not insert more than one memory card or a storage device at a time. If more than one memory card is inserted, or if a storage device is connected when a memory card is inserted, unrecoverable data loss might occur.
-

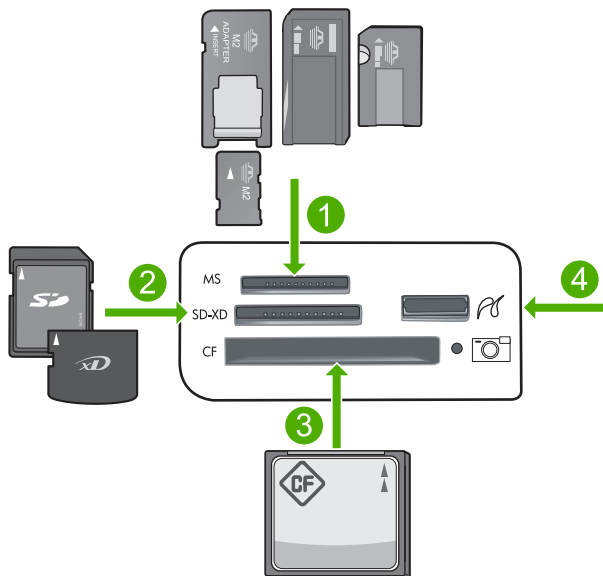

- | | |
|---|--|
| 1 | Memory Stick, Memory Stick Pro, Memory Stick Select, Memory Stick Magic Gate, Memory Stick Duo or Duo Pro (adapter optional), or Memory Stick Micro (adapter required) |
| 2 | MultiMediaCard (MMC), MMC Plus, Secure MultiMedia Card, MMC Mobile (RS-MMC; adapter required), Secure Digital (SD), Secure Digital Mini, Secure Digital High Capacity (SDHC), TransFlash MicroSD Card (adapter required), or xD-Picture card |
| 3 | CompactFlash (CF) types I and II |
| 4 | Front USB port (for storage devices) |

To insert a memory card

1. Make sure the product is on.
2. Insert the memory card or storage device into the appropriate slot.
The memory card area has a Photo light (below the camera icon) that indicates the status of the memory card. When it is solid green, your photos are ready to be viewed.

△ **CAUTION:** Do not pull out the memory card while the Photo light is flashing. A flashing light means the product is accessing the memory card. Wait until the light remains solid. Removing a memory card while it is being accessed might corrupt information on the card or damage the product or memory card.

📄 **NOTE:** The product only recognizes the JPG and TIF file formats on your memory card or storage device.

Print photos

You can print the photos on your memory card or storage device in a variety of sizes, from 10 x 15 cm (4 x 6 inch) up to the size of letter or A4 paper, including multiple small-size photos on a single page.

 **TIP:** To achieve the best print quality, HP recommends using HP papers that are specifically designed for the type of project you are printing along with genuine HP ink. HP papers and HP ink are specifically designed to work well together to provide high-quality output.

To print photos

1. Load photo paper in the appropriate input tray.
 - Load up to 13 x 18 cm (5 x 7 inch) photo paper in the photo tray.
 - Load full-size photo paper in the main input tray.
2. Insert a memory card into the appropriate slot on the product or connect a storage device to the front USB port.

 **NOTE:** If there are camera-selected photos on the memory device, the **DPOF Found** screen appears. Select **Yes** to print the camera-selected photos, or select **No** to browse through the photos on the memory device.

3. Press **OK** to select **View & Print**.
4. Press the left or right arrow button to scroll through the thumbnails of your photos.

 **TIP:** If you want to print all the photos on your card, press the Menu button and select **Select All Photos & Preview**.

5. When the photo you want to print is highlighted, press **OK**.

 **TIP:** If you want to print one copy of the photo using the default print settings, when the photo is highlighted, press **Print Photos** twice instead of pressing **OK**.

6. Press the up arrow button to increase the number of copies. You must specify at least one copy or the photo will not print.

 **TIP:** If you want to crop, rotate, or make any other changes to the photo before printing, press the Menu button.

7. (Optional) Continue left-right scrolling to add more photos to the print queue.
8. Press **OK** to preview the print job.
9. (Optional) Press the Menu button to change the print settings.



10. Press **Print Photos**.



 **TIP:** During printing, you can press **OK** to add more photos to the print queue.

Related topics

[“Edit photos using the control panel” on page 75](#)

Create special projects from your photos

The HP All-in-One enables you to create special projects from your photos, including:

- Photo albums
- Panorama prints
- Wallet-size photos
- Passport-size photos

To create special projects

1. Insert a memory card into the appropriate slot on the product or connect a storage device to the front USB port.



NOTE: If there are camera-selected photos on the memory device, the **DPOF Found** screen appears. Select **Yes** to print the camera-selected photos, or select **No** to browse through the photos on the memory device.

2. Make sure the photo tray or main input tray is loaded with the correct paper for the type of project you are creating.
3. Press the left arrow or right arrow button to highlight **Create**, and then press **OK**.
4. Press the left arrow or right arrow button to scroll through the projects. When the project you want to create is highlighted, press **OK**.
 - **Album Pages:** Enables you to select multiple photos and print them onto a series of themed album pages, which you can then bind to create a photo album. The photos in your album pages are placed in the same orientation for a visually pleasing presentation.
 - **Panorama Prints:** Enables you to print an existing wide angle (or panoramic) photo.



TIP: Some cameras have a panoramic mode that produces wide angle photos automatically. You can also "stitch" a series photos together using photo editing software, then save the file on your memory card for printing.

- **Wallets:** Enables you to print your own wallet-size photos to carry with you or give to friends or relatives.
 - **Passport Photos:** Enables you to print your own passport-size photos. (If you have questions on guidelines or restrictions for passport photos, contact a local passport service agency.)
5. Respond to the prompts for the project you are creating.
 6. At the **Print Preview** screen, press **Print Photos**.

Save photos to your computer

You can use the HP Photosmart Software installed on your computer to transfer photos from a memory card or storage device to your computer's hard drive for sharing photos online and printing from your computer.



NOTE: The HP All-in-One must be connected to a computer that has the HP Photosmart Software installed on it.

To save photos

1. Insert a memory card into the appropriate slot on the product or connect a storage device to the front USB port.
2. Press the right arrow button until **Save** is highlighted, and then press **OK**.
3. Follow the onscreen prompts on your computer to save the photos to your computer.

Edit photos using the control panel

The HP All-in-One offers several basic editing features that you can use to edit your photos manually before you print them, as well as a feature that enables you to automatically enhance your photos.

This section contains the following topics:

- [Remove red-eye](#)
- [Rotate a photo](#)
- [Zoom and pan to crop a photo](#)
- [Automatically enhance your photos](#)
- [Print a frame around your photo](#)
- [Adjust the brightness of your photos](#)
- [Apply special color effects to your photos](#)

Remove red-eye

The flash on a camera (especially on older camera models) can sometimes cause a subject's eyes to appear red in your photos. The HP All-in-One is set to automatically remove redness so that eyes appear the correct shade in your photos.

 **NOTE:** The changes you make to the photo apply only to viewing and printing the photo. The changes will not be saved on the memory card.

 **NOTE:** This feature is only available when a memory card or storage device is inserted.

To remove red-eye from photos

- ▲ By default, red-eye correction is automatically applied to all photos in the print queue. To turn off this feature, press the **Red-Eye Removal** button on the control panel when a memory card or storage device is inserted.



Related topics

["Print photos" on page 72](#)

Rotate a photo

Depending on how you were holding your digital camera at the time you took a photo, the photo might appear sideways or upside down on the display. You might need to rotate the photo to make it show properly on the display.

 **NOTE:** The HP All-in-One automatically adjusts the rotation so photos print properly on the page. When printing more than one, the photos are oriented to fit a maximum number of photos on the page.

To rotate a photo

1. Press the Menu button on the photo selection screen.



2. In the Edit Photo menu, press the up arrow or down arrow button to highlight **Rotate**, and then press **OK**.
3. Press the right arrow button repeatedly to rotate the image clockwise in 90 degree increments.
4. When you are done rotating the image, press **OK**.

Related topics

- [“Print photos” on page 72](#)
- [“Make reprints of your photos” on page 93](#)

Zoom and pan to crop a photo

The HP All-in-One enables you to zoom in or out on a specific area of a photo. When you print the photo, the photo is cropped so only the area shown on the display prints.

 **NOTE:** The changes you make to the photo apply only to viewing and printing the photo. The changes will not be saved on the memory card.

To crop a photo

1. Press the Menu button on the photo selection screen.



2. In the Edit Photo menu, press the up arrow or down arrow button to highlight **Crop**, and then press **OK**.
3. Press the Zoom in button or the Zoom out button to zoom closer to or farther away from the subject of the photo.



An outline appears on the photo to show you an approximate view of the area that will print.

4. Press the arrows on the directional pad to pan around the photo and select a specific area to print.
5. Press **OK** to crop the photo.

Related topics

- [“Print photos” on page 72](#)
- [“Make reprints of your photos” on page 93](#)

Automatically enhance your photos

The HP All-in-One is set up, by default, to enhance your photos automatically when you print them. When this feature is enabled, the HP All-in-One uses **HP Real Life Technologies** to:

- Adjust the brightness or darkness of your photos (shown in print preview and printed output)
- Adjust the lighting to make dark images appear brighter (shown on printed output only)
- Sharpen blurry images (shown on printed output only)

You can turn off the automatic photo enhancement feature for individual photos, on a per-image basis.

To turn off automatic photo enhancement

1. Press the Menu button on the photo selection screen.



2. In the Edit Photo menu, press the up arrow or down arrow button to highlight **Photo Fix**, and then press **OK**.
3. Press the up arrow or down arrow button to highlight **Off**, and then press **OK**.

Related topics

- [“Print photos” on page 72](#)

Print a frame around your photo

You can print a decorative colored border around the outside edge of your photo to frame the photo.

 **NOTE:** The changes you make to the photo apply only to viewing and printing the photo. The changes will not be saved on the memory card.

To print a frame around your photo

1. Press the Menu button on the photo selection screen.



2. In the Edit Photos menu, press the up arrow or down arrow button until **Frame** is highlighted, and then press **OK**.
3. Press the left arrow or right arrow button to scroll through the frames.
4. When the frame you want is highlighted, press **OK**.
The selected frame is applied to the photo and shown by itself on the display.

Related topics

[“Print photos” on page 72](#)

Adjust the brightness of your photos

You can adjust the brightness of a photo so that it prints lighter or darker than the original photo you took with your digital camera.

 **NOTE:** The changes you make to the photo apply only to viewing and printing the photo. The changes will not be saved on the memory card.

To adjust the brightness

1. Press the Menu button on the photo selection screen.



2. In the Edit Photo menu, press the up arrow or down arrow button to highlight **Brightness**, and then press **OK**.
3. Press the left arrow or right arrow button to increase or decrease the brightness of the photo.
The current brightness selection is indicated by the vertical line on the sidebar.
4. When you are done adjusting brightness, press **OK**.

Related topics

- [“Print photos” on page 72](#)
- [“Make reprints of your photos” on page 93](#)

Apply special color effects to your photos

You can apply special color effects to a photo so that it prints with a sepia, hand-tinted, or black-and-white finish.

 **NOTE:** The changes you make to the photo apply only to viewing and printing the photo. The changes will not be saved on the memory card.

To change the color effects

1. Press the Menu button on the photo selection screen.



2. In the Edit Photos menu, press the up arrow or down arrow button to highlight **Color Effect**, and then press **OK**.
3. Press the up arrow or down arrow button to select one of the following color effect options, and then press **OK**:

No Effect	Does not apply any special color effects to your photo.
Black & White	Prints the photo in black and white.
Sepia	Applies brown tones, similar to photos produced in the early 1900s, to your photo.
Antique	Applies brown tones along with some pale colors to your photo. With this option, your photo will look like it was hand-tinted.

Related topics

- [“Print photos”](#) on page 72
- [“Make reprints of your photos”](#) on page 93

9 Use the scan features

Scanning is the process of converting text and pictures into an electronic format for your computer. You can scan almost anything (photos, magazine articles and text documents) on the HP All-in-One.

You can use the scanning features of the HP All-in-One to do the following:

- Scan text from an article into your word processor and quote it in a report.
- Print business cards and brochures by scanning a logo and using it in your publishing software.
- Send photos to friends and relatives by scanning your favorite prints and including them in e-mail messages.
- Create a photographic inventory of your house or office.
- Archive treasured photos in an electronic scrapbook.

This section contains the following topics:

- [Scan an image](#)
- [Edit a scanned image](#)
- [Edit a scanned document](#)
- [Stop scanning](#)

Scan an image

You can scan to a connected computer that has the HP Photosmart Software installed or to a connected memory card or storage device.

 **NOTE:** You can also use the software you installed with the HP All-in-One to scan images. Using this software, you can edit a scanned image and create special projects using a scanned image. For more information, see the software help.

This section contains the following topics:

- [Scan an original to a computer](#)
- [Scan an original to a memory card](#)

Scan an original to a computer

You can scan originals placed on the glass by using the control panel.

 **NOTE:** To use the scan features, the HP All-in-One and computer must be connected and turned on. The HP Photosmart Software must also be installed and running on your computer prior to scanning. To verify that the HP Photosmart Software is running on a Windows computer, look for the HP All-in-One icon in the system tray at the lower right side of the screen, near the time.

NOTE: Closing the **HP Digital Imaging Monitor** icon in the Windows system tray can cause the HP All-in-One to lose some of its scan functionality. If this happens, you can restore full functionality by restarting your computer or by starting the HP Photosmart Software.

 **NOTE:** When scanning, the HP Photosmart Software enables you to save an image in the following file formats: BMP, DCX, FXP, GIF, JPG, PCD, PCX, and TIF.

To scan to a computer

1. Load your original print side down on the right front corner of the glass.

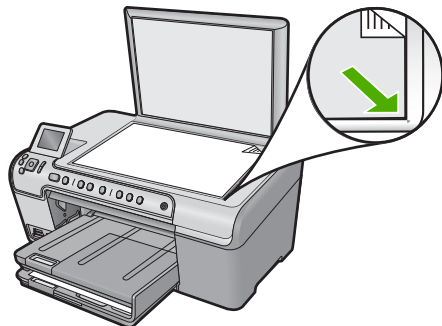

2. Press **Start Scan** on the control panel.
3. Press the down arrow button to highlight **Scan to Computer**, and then press **OK**.
4. The **Scan To** menu appears on the display. Press the down arrow button to select the job shortcut you want to use, and then press **OK**.

 **NOTE:** Job shortcuts define scan parameters, such as the software application, dpi, and color settings so you do not need to set them for each scan job.

A preview image of the scan appears on your computer, where you can edit it.

5. Follow the onscreen prompts to save the scan to your computer.

Scan an original to a memory card

You can send the scanned image as a JPEG image to the memory card or storage device that is currently inserted. This enables you to use the photo print options to print borderless prints and album pages from the scanned image.

To save a scan to the memory card or storage device

1. Make sure your memory card is inserted into the appropriate slot on the product, or a storage device is connected to the front USB port.
2. Load your original print side down on the right front corner of the glass.

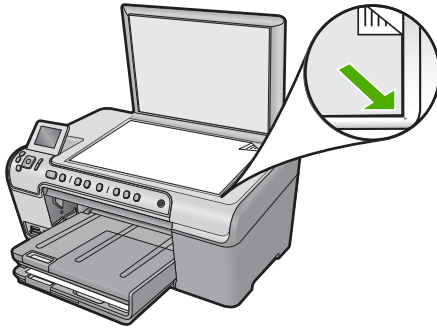

3. Press **Start Scan**.
4. Press the down arrow button to highlight **Scan to Memory Card** or **Scan to USB Flash Drive**, and then press **OK**.
The product scans the image and saves the file to the memory card or storage device in the JPEG format.

Edit a scanned image

You can edit a scanned image, such as a photo or graphic, using the software you installed with the HP All-in-One. Using this software, you can rotate or crop the image, as well as adjust the brightness, contrast, and color saturation.

Related topics

[“Use the HP Photosmart Software” on page 14](#)

Edit a scanned document

You can edit a scanned document using your Optical Character Recognition (OCR) software. Scanning text using OCR software enables you to bring the content of magazine articles, books, and other printed matter into your favorite word processor and many other applications as editable text. Learning to use OCR software correctly is important if you want to obtain the best results. Do not expect scanned text documents to be letter-perfect the first time you use your OCR software. Using OCR software is an art that takes time and practice to master.

Related topics

[“Use the HP Photosmart Software” on page 14](#)

Stop scanning

To stop scanning

- ▲ Press Cancel on the control panel.

10 Use the copy features

The HP All-in-One enables you to produce high-quality color and black-and-white copies on a variety of paper types, including transparencies. You can enlarge or reduce the size of an original to fit a specific paper size, adjust the darkness of the copy, and use special features to make high-quality copies of photos, including borderless copies.

 **TIP:** For the best copy performance on standard copy projects, set the paper size to **Letter** or **A4**, the paper type to **Plain Paper**, and the copy quality to **Fast**.

This section contains the following topics:

- [Make a copy](#)
- [Preview your copy job](#)
- [Change the copy settings for the current job](#)
- [Change default copy settings](#)
- [Perform special copy jobs](#)
- [Stop copying](#)

Make a copy

You can make quality copies from the control panel.

To make a copy from the control panel

1. Make sure you have paper loaded in the input tray.

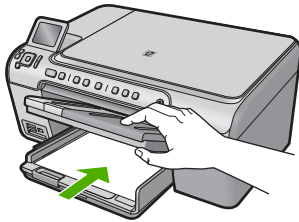

2. Load your original print side down on the right front corner of the glass.

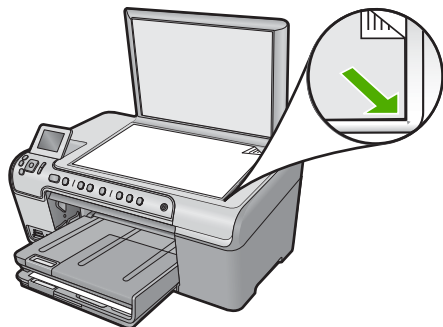

3. Press **Start Copy Black** or **Start Copy Color** to begin copying.

Preview your copy job

After changing settings on the HP All-in-One for making a copy, you can preview an image of the expected output on the display before starting the copy.

 **NOTE:** To ensure an accurate preview, change the paper size and type to reflect the actual paper you have loaded in the input tray. If you use the Automatic settings, the onscreen preview might not accurately represent the output. Instead, the preview will reflect what the output would be if the default paper type and size were loaded in the input tray.

Previews appear when you select **Preview** on the **Copy Menu**, or when you use the crop feature to specify a specific area of the original to copy.

To preview your copy from the control panel

1. Press **OK** when **Copy** is highlighted on the Home Screen.
2. Press the Menu button to select **Copy Settings**.



3. Change copy settings on the product to accurately reflect the copy you want to make.
4. Press the down arrow button to highlight **Preview**, and then press **OK**.
An image on the display shows how your copy will print.
5. Press **Start Copy Black** or **Start Copy Color** to accept the preview and begin copying.

Change the copy settings for the current job

You can customize the copy settings of the HP All-in-One to handle nearly any copy task.

This section contains the following topics:

- [Set the number of copies](#)
- [Set the copy paper size](#)
- [Set the copy paper type](#)
- [Change copy speed or quality](#)
- [Adjust the lightness and darkness of your copy](#)

Set the number of copies

You can set the number of copies from the control panel of the HP All-in-One or from the HP Photosmart Software. This task explains how to set the number of copies from the control panel only.

To set the number of copies from the control panel

1. Press **OK** when **Copy** is highlighted on the Home Screen.
2. Press the up arrow button to increase the number of copies, up to the maximum. (The maximum number of copies varies by model.)
3. Press **Start Copy Black** or **Start Copy Color**.

Set the copy paper size

You can set the paper size on the HP All-in-One. The paper size you select should match what is loaded in the input tray.

To set the paper size from the control panel

1. Press **OK** when **Copy** is highlighted on the Home Screen.
2. Press the Menu button to select **Copy Settings**.



3. Press the down arrow button to highlight **Paper Size** and then press **OK**.
4. Press the down arrow button to highlight the appropriate paper size present in the input tray, and then press **OK**.

Set the copy paper type

You can set the paper type on the HP All-in-One. The default paper type setting for copying is **Automatic**, which causes the HP All-in-One to detect the type of paper in the input tray.

To set the paper type for copies

1. Press **OK** when **Copy** is highlighted on the Home Screen.
2. Press the Menu button to select **Copy Settings**.



3. Press the down arrow button to highlight **Paper Type**, and then press **OK**.
4. Press the down arrow button until the appropriate paper type appears, and then press **OK**.

Refer to the following table to determine which paper type setting to choose based on the paper loaded in the input tray.

Paper type	Control panel setting
Copier paper or letterhead	Plain Paper
HP Bright White Paper	Plain Paper
HP Premium Plus Photo Paper, Glossy	Premium Photo
HP Premium Plus Photo Paper, Matte	Premium Photo
HP Premium Plus 10 x 15 cm (4 x 6 inch) Photo Paper	Premium Photo
HP Photo Paper	Photo Paper
HP Everyday Photo Paper	Everyday Photo
HP Everyday Photo Paper, Semi Gloss	Everyday Matte
HP Premium Paper	Premium Inkjet
Other inkjet paper	Premium Inkjet
HP Professional Brochure & Flyer Paper (Glossy)	Brochure Glossy
HP Professional Brochure & Flyer Paper (Matte)	Brochure Matte
HP Premium or Premium Plus Inkjet Transparency Film	Transparency
Other transparency film	Transparency
Plain Hagaki	Plain Paper
Glossy Hagaki	Premium Photo
L (Japan only)	Premium Photo
Advanced Photo Paper	Advanced Photo

Change copy speed or quality

The HP All-in-One provides three options that affect copy speed and quality:

- **Best** produces high quality for all paper and eliminates the banding (striping) effect that sometimes occurs in solid areas. **Best** copies slower than the **Normal** or **Fast** quality settings.
- **Normal** delivers high quality and is the recommended setting for most of your copying. **Normal** copies faster than **Best** and is the default setting.
- **Fast** copies faster than the **Normal** setting. The text is comparable to the quality of the **Normal** setting, but the graphics might be lower quality. The **Fast** setting uses less ink and extends the life of your ink cartridges.

To change the copy quality from the control panel

1. Press **OK** when **Copy** is highlighted on the Home Screen.
2. Press the Menu button to select **Copy Settings**.



3. Press the down arrow button to highlight **Quality**, and then press **OK**.
4. Press the up arrow or down arrow button to select a copy quality, and then press **OK**.

Adjust the lightness and darkness of your copy

You can use the **Lighter/Darker** option to adjust the contrast of the copies you make.

To adjust the copy contrast from the control panel

1. Press **OK** when **Copy** is highlighted on the Home Screen.
2. Press the Menu button to select **Copy Settings**.



3. Press the down arrow button to highlight **Lighter/Darker**, and then press **OK**.
4. Do one of the following:
 - Press the right arrow button to darken the copy.
 - Press the left arrow button to lighten the copy.
5. Press **OK**.

Change default copy settings

When you change copy settings from the control panel, the settings apply only to the current copy job. To apply copy settings to all future copy jobs, you can save the settings as defaults.

To set default copy settings from the control panel

1. Make any needed changes to the Copy settings.
2. Press **OK** when **Copy** is highlighted on the Home Screen.
3. Press the Menu button to select **Copy Settings**.



4. Press the down arrow button to highlight **Set as New Defaults**, and then press **OK**.
5. Press **OK** to confirm.

 **NOTE:** The settings you specify here are only saved on the product. They do not adjust the settings in the software. You can save your most frequently used software settings by using the HP Photosmart software.

Perform special copy jobs

In addition to supporting standard copy jobs, the HP All-in-One can perform special jobs such as cropping and resizing originals.

 **NOTE:** If you want to copy a photo, use the Reprints features. In addition to making an exact copy of the original, the Reprints feature also enables you to edit the lighting and colors before printing, as well as zoom and crop a specific area for printing.

This section contains the following topics:

- [Resize an original to fit onto letter or A4 paper](#)
- [Crop an original](#)
- [Shift the left margin](#)
- [Improve the quality of a copy](#)

Related topics

[“Use the reprint features” on page 93](#)

Resize an original to fit onto letter or A4 paper

The HP All-in-One enables you to make a different size copy than your original. For example, if you are copying a page from a small book, you can enlarge the copy so it fills the page and is easier to read. Similarly, if the original is larger than the paper you have loaded, you can reduce the copy so none of the original content is cropped.

Press the down arrow button or the up arrow button to highlight one of the following, and then press **OK**.

- **Actual Size:** This feature enables you to print an exact copy of the original.
- **Fit to Page:** This feature enables you to copy an original to fit within the printable margins of a page without the risk of cropping some part of your original.

 **NOTE:** In order to resize your original without changing the proportions or cropping the edges, the HP All-in-One might leave an uneven amount of white space around the edges of the paper.

- **Custom 100%:** This feature enables you to reduce or enlarge a copy of a document.

To resize a document from the control panel

1. Press **OK** when **Copy** is highlighted on the Home Screen.
2. Press the Menu button to select **Copy Settings**.



3. Press the down arrow button to highlight **Size**, and then press **OK**.
4. Press the up arrow or down arrow button to highlight the appropriate copy size, and then press **OK**.

Crop an original

After changing settings on the HP All-in-One for making a copy, you can use the crop feature to specify a particular area of the original to copy.

To crop your copy from the control panel

1. Press **OK** when **Copy** is highlighted on the Home Screen.
2. Press the Menu button to select **Copy Settings**.



3. Change copy settings on the product to accurately reflect the copy you want to make.
4. Press the down arrow button to highlight **Crop**, and then press **OK**.
5. Press the arrows on the directional pad to move the cursor to the upper left corner where you want the crop to begin, and then press **OK**.
6. Press the down arrow and right arrow button to move the cursor to the lower right corner of the crop area, and then press **OK**.

The product shows a preview image of the expected output on the display.

7. Press **Start Copy Black** or **Start Copy Color** to accept the preview and begin copying.

Shift the left margin

If you are planning to bind your copies along the left edge (for example, in a 3-ring binder), you can shift your copy slightly to the right, so that the words or images on the left side of the page do not extend into the binding margin.

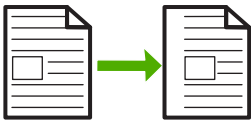

 **NOTE:** The HP All-in-One shifts the words and images approximately 9.5 mm (0.37 inch) to the right. To reduce the chances of cropping along the right edge as a result, do not use the **Margin Shift** and enlargement features together.

To shift the margin for your copy from the control panel

1. Press **OK** when **Copy** is highlighted on the Home Screen.
2. Press the Menu button to select **Copy Settings**.



3. Change copy settings on the product to accurately reflect the copy you want to make.
4. Press the down arrow button to highlight **Margin Shift**, and then press **OK**.
5. Press the up arrow button to highlight **On**, and then press **OK**.

Improve the quality of a copy

The HP All-in-One is designed to produce high-quality copies of documents containing both text and images.

However, you might need to change the **Enhancements** setting if the document you are copying contains just text or just an image, and you notice any of the following:

- Stray dots of color surround some text on your copies
- Large, black typefaces look splotchy (not smooth)
- Thin, colored objects or lines contain black sections
- Horizontal grainy or white bands appear in light- to medium-gray areas

To correct copy quality issues

1. Press **OK** when **Copy** is highlighted on the Home Screen.
2. Press the Menu button to select **Copy Settings**.



3. Press the down arrow button to highlight **Enhancements**, and then press **OK**.
4. Press the up arrow or down arrow button to highlight the type of document you are copying (**Text**, **Photo**, or **Mixed**), and then press **OK**.



NOTE: You can also try turning off **Enhancements** if you are seeing quality issues when copying.

Stop copying**To stop copying**

- ▲ Press Cancel on the control panel.

11 Use the reprint features

The HP All-in-One enables you to make reprints of photographic originals placed on the glass.

This section contains the following topics:

- [Make reprints of your photos](#)
- [Edit a photo before reprinting](#)

Make reprints of your photos

You can scan a printed copy of a photo to make reprints in a variety of sizes, up to the size of letter or A4 paper.

By default, the HP All-in-One is set to detect the type of paper you are using automatically. For the best results when reprinting photos, leave the **Paper Type** set to **Automatic**, and load photo paper in the HP All-in-One. You should only change the **Paper Type** if you see print quality issues using the **Automatic** setting.

To reprint an original photo

1. Load your original print side down on the right front corner of the glass.
2. Make sure the photo tray or main tray is loaded with the correct paper.
3. Press the right arrow button to highlight **Reprints**, and then press **OK**.
4. (Optional) Press the Menu button to change print settings before reprinting.
 - a. Press the left arrow or right arrow button to highlight the print layout pattern, and then press **OK**.
 - b. (Optional) Press the up arrow button to increase the number of copies.
 - c. (Optional) Press the Menu button on the reprint selection screen to edit the photo.
 - d. When you are done, press **OK**.
5. Press **Print Photos**.

Edit a photo before reprinting

The HP All-in-One offers several basic editing features that you can use to edit your photos manually before you make reprints of them.

This section contains the following topics:

- [Fix a faded original](#)
- [Rotate a photo](#)
- [Zoom and pan to crop a photo](#)
- [Adjust the brightness of your photos](#)
- [Apply special color effects to your photos](#)

Fix a faded original

If your photo has faded from age or sun exposure, you can fix it so that the colors in your reprint are more accurate to the original coloring.

To fix a faded original photo when making a reprint

1. Press the Menu button on the reprint selection screen.



2. In the Edit Photo menu, press the up arrow or down arrow button to highlight **Fix Faded Original**, and then press **OK**.
3. Press the up arrow or down arrow button to highlight **Yes**, and then press **OK**.

Related topics

[“Make reprints of your photos” on page 93](#)

Rotate a photo

Depending on how you placed your original on the glass to copy it, the photo might appear sideways or upside down on the display. You might need to rotate the photo to make it show properly on the display.

 **NOTE:** The HP All-in-One automatically adjusts the rotation so photos print properly on the page. When printing more than one, the photos are oriented to fit a maximum number of photos on the page.

To rotate a photo

1. Press the Menu button on the reprint selection screen.



2. In the Edit Photo menu, press the up arrow or down arrow button to highlight **Rotate**, and then press **OK**.
3. Press the right arrow button repeatedly to rotate the image clockwise in 90 degree increments.
4. When you are done rotating the image, press **OK**.

Related topics

- [“Print photos” on page 72](#)
- [“Make reprints of your photos” on page 93](#)

Zoom and pan to crop a photo

The HP All-in-One enables you to zoom in or out and print any particular portion of a photo. When you print the photo, only the cropped area shown on the display prints.

To crop a photo

1. Press the Menu button on the reprint selection screen.



2. In the Edit Photo menu, press the up arrow or down arrow button to highlight **Crop**, and then press **OK**.
3. Press the Zoom in button or the Zoom out button to zoom closer to or farther away from the subject of the photo.



An outline appears on the photo to show you an approximate view of the area that will print.

4. Press the arrows on the directional pad to pan around the photo and select a specific area to print.
5. Press **OK** to crop the photo.

Related topics

- [“Print photos” on page 72](#)
- [“Make reprints of your photos” on page 93](#)

Adjust the brightness of your photos

You can adjust the brightness of a photo so that it prints lighter or darker than your original.

To adjust the brightness

1. Press the Menu button on the reprint selection screen.



2. In the Edit Photo menu, press the up arrow or down arrow button to highlight **Brightness**, and then press **OK**.
3. Press the left arrow or right arrow button to increase or decrease the brightness of the photo.

The current brightness selection is indicated by the vertical line on the sidebar.

4. When you are done adjusting brightness, press **OK**.

Related topics

- [“Print photos” on page 72](#)
- [“Make reprints of your photos” on page 93](#)

Apply special color effects to your photos

You can apply special color effects to a photo so that it prints with a sepia, hand-tinted, or black-and-white finish.

To change the color effects

1. Press the Menu button on the reprint selection screen.



2. In the Edit Photos menu, press the up arrow or down arrow button to highlight **Color Effect**, and then press **OK**.
3. Press the up arrow or down arrow button to select one of the following color effect options, and then press **OK**:

No Effect	Does not apply any special color effects to your photo.
Black & White	Prints the photo in black and white.
Sepia	Applies brown tones, similar to photos produced in the early 1900s, to your photo.
Antique	Applies brown tones along with some pale colors to your photo. With this option, your photo will look like it was hand-tinted.

Related topics

- [“Print photos” on page 72](#)
- [“Make reprints of your photos” on page 93](#)

12 Maintain the HP All-in-One

The HP All-in-One requires little maintenance. Sometimes you might want to clean the glass and lid backing to remove surface dust and ensure that your copies and scans remain clear. You will also need to replace, align, or clean your print cartridges from time to time. This section provides instructions for keeping the HP All-in-One in top working condition. Perform these simple maintenance procedures as necessary.

This section contains the following topics:

- [Work with print cartridges](#)
- [Print a self-test report](#)
- [Clean the HP All-in-One](#)
- [Turn off the HP All-in-One](#)

Work with print cartridges

To ensure the best print quality from the HP All-in-One, you will need to perform some simple maintenance procedures. This section provides guidelines for handling the print cartridges and instructions for replacing, aligning, and cleaning the print cartridges.

This section contains the following topics:

- [Handle the print cartridges](#)
- [Check the estimated ink levels](#)
- [Replace the print cartridges](#)
- [Use a photo print cartridge](#)
- [Use the print cartridge protector](#)
- [Remove ink from your skin and clothing](#)
- [Ink-backup mode](#)
- [Advanced print cartridge maintenance](#)

Handle the print cartridges

Before you replace or clean a print cartridge, you should know the part names and how to handle the print cartridges.

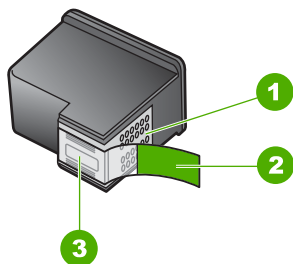

1	Copper-colored contacts
2	Plastic tape with pink pull tab (must be removed before installing)
3	Ink nozzles under tape

Hold the print cartridges by their black plastic sides, with the label on top. Do not touch the copper-colored contacts or the ink nozzles.



 **NOTE:** Handle the print cartridges carefully. Dropping or jarring cartridges can cause temporary printing problems, or even permanent damage.

Check the estimated ink levels

You can easily check the ink supply level to determine how soon you might need to replace a print cartridge. The ink supply level shows an estimate of the amount of ink remaining in the print cartridges.

 **NOTE:** If you have installed a refilled or remanufactured cartridge, or a cartridge that has been used in another printer, the ink level indicator might be inaccurate or unavailable.

NOTE: Ink level warnings and indicators provide estimates for planning purposes only. When you receive a low-ink warning message, consider having a replacement cartridge available to avoid possible printing delays.

NOTE: Ink from the cartridges is used in the printing process in a number of different ways, including in the initialization process, which prepares the product and cartridges for printing, and in printhead servicing, which keeps print nozzles clear and ink flowing smoothly. In addition, some residual ink is left in the cartridge after it is used. For more information, see www.hp.com/go/inkusage.

To check the ink levels from the control panel

1. Press **Setup**.



2. Press the down arrow button to highlight **Tools**, and then press **OK**.
3. Press the down arrow button to highlight **Display Ink Gauge**, and then press **OK**. The product displays a gauge that shows the estimated ink levels of all cartridges installed.
4. Press any button to return to the **Tools** menu.

To check the ink levels from the HP Photosmart Software

1. In the HP Solution Center, click **Settings**, point to **Print Settings**, and then click **Printer Toolbox**.



NOTE: You can also open the **Printer Toolbox** from the **Print Properties** dialog box. In the **Print Properties** dialog box, click the **Features** tab, and then click the **Printer Services** button.

The **Printer Toolbox** appears.

2. Click the **Estimated Ink Level** tab. The estimated ink levels for the print cartridges appear.

Replace the print cartridges

Follow these instructions when the ink level is low.



NOTE: When the ink level for the print cartridge is low, messages appear on the display and the computer screen. You can also check the ink levels at any time from the control panel or the HP Photosmart Software.

NOTE: Ink level warnings and indicators provide estimates for planning purposes only. When you receive a low-ink warning message, consider having a replacement cartridge available to avoid possible printing delays. You do not have to replace the cartridges until the print quality is unacceptable.

When you receive a low-ink warning message, make sure you have a replacement print cartridge available. You should also replace the print cartridges when you see faded text or if you experience print quality issues related to the print cartridges.

To order print cartridges for the HP All-in-One, go to www.hp.com/buy/supplies. If prompted, choose your country/region, follow the prompts to select your product, and then click one of the shopping links on the page.

 **NOTE:** At this time, some portions of the HP Web site are available in English only.

Choose the right cartridge combination

Choose the best combination of cartridges for your print job:

- Everyday printing: Use a black cartridge along with a tri-color cartridge.
- Color photos: Use a photo cartridge along with a tri-color cartridge.

To replace the print cartridges

1. Make sure the product is turned on.

 **CAUTION:** If the product is turned off when you open the print cartridge door to access the print cartridges, it will not release the cartridges for changing. You might damage the product if the print cartridges are not docked safely when you try to remove them.

2. Make sure you have letter or A4 unused plain white paper loaded in the input tray.
3. Open the print cartridge door.

The print carriage moves to the far right side of the product.

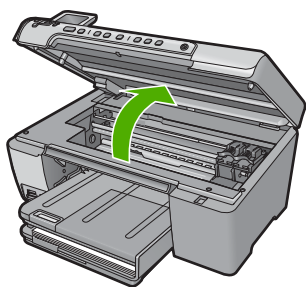

4. Wait until the print carriage is idle and silent. Lightly press down on a print cartridge to release it, and then pull the print cartridge toward you out of its slot.
If you are replacing the tri-color print cartridge, remove the print cartridge from the slot on the left.

If you are replacing the black or photo print cartridge, remove the print cartridge from the slot on the right.

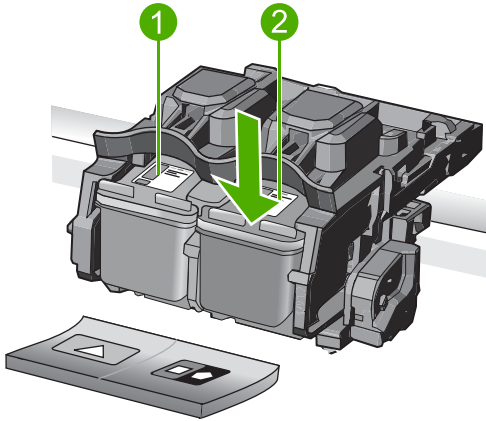

1	Print cartridge slot for the tri-color print cartridge
2	Print cartridge slot for the black and photo print cartridges

TIP: If you are removing the black print cartridge in order to install the photo print cartridge, store the black print cartridge in the print cartridge protector or an airtight plastic container.

- Remove the new print cartridge from its packaging and, being careful to touch only the black plastic, gently remove the plastic tape by using the pink pull tab.

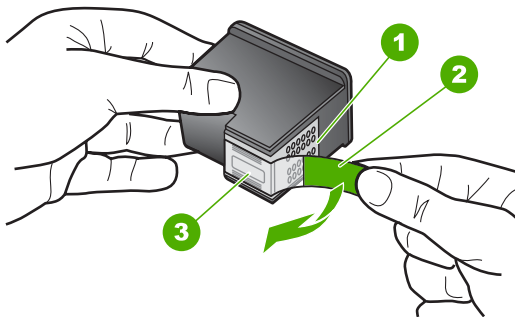

1	Copper-colored contacts
2	Plastic tape with pink pull tab (must be removed before installing)
3	Ink nozzles under tape

CAUTION: Do not touch the copper-colored contacts or ink nozzles. Also, do not re-tape the print cartridges. Doing so can result in clogs, ink failure, and bad electrical connections.



6. Hold the print cartridge with the HP logo on top, and insert the new print cartridge into the empty cartridge slot. Make sure you push the print cartridge in firmly until it snaps into place.

If you are installing the tri-color print cartridge, slide it into the left slot.

If you are installing a black or photo print cartridge, slide it into the right slot.

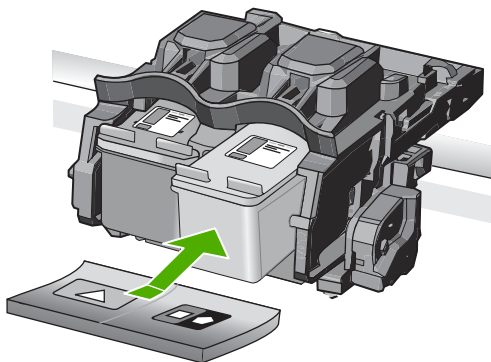

7. Close the print cartridge door.

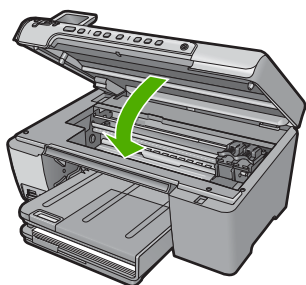

8. When prompted, press **OK**.

The product prints a print cartridge alignment page. Recycle or discard the alignment page.

 **NOTE:** If you have colored paper loaded in the input tray when you align the print cartridges, the alignment will fail. Load unused plain white paper into the input tray, and then try the alignment again.

Related topics

- [“Align the print cartridges”](#) on page 106
- [“Use a photo print cartridge”](#) on page 103
- [“Use the print cartridge protector”](#) on page 103

Use a photo print cartridge

You can optimize the quality of the color photos you print and copy with the HP All-in-One by purchasing a photo print cartridge. Remove the black print cartridge and insert the photo print cartridge in its place. With the tri-color print cartridge and photo print cartridge installed, you have a six-ink system, which provides enhanced quality color photos.

When you want to print regular text documents, swap the black print cartridge back in. Use a print cartridge protector or an airtight plastic container to keep your print cartridge secure when it is not being used.

Related topics

- [“Replace the print cartridges”](#) on page 99
- [“Use the print cartridge protector”](#) on page 103

Use the print cartridge protector

In some countries/regions, when you purchase a photo print cartridge, you might also receive a print cartridge protector. In other countries/regions, a print cartridge protector comes in the box with the HP All-in-One. If neither your print cartridge nor the HP All-in-One came with a print cartridge protector, you can use an airtight plastic container to protect your print cartridge.

 **NOTE:** If you use a plastic container, make sure the ink nozzles on the print cartridge do not touch the plastic.

The print cartridge protector is designed to keep a print cartridge secure and prevent it from drying out when it is not being used. Whenever you remove a print cartridge from the HP All-in-One with the intention of using it again later, store it in the print cartridge protector. For example, store the black print cartridge in a print cartridge protector if you are removing it so you can print high-quality photos with the photo and tri-color print cartridges.

To insert a print cartridge into the print cartridge protector

- ▲ Place the print cartridge into the print cartridge protector at a slight angle and snap it securely into place.

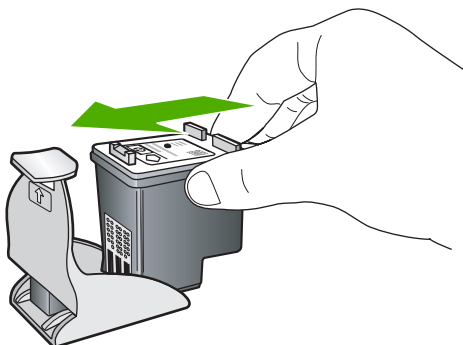

To remove the print cartridge from the print cartridge protector

- ▲ Press down on the top of the print cartridge protector to release the print cartridge, and then gently remove the print cartridge out of the print cartridge protector.

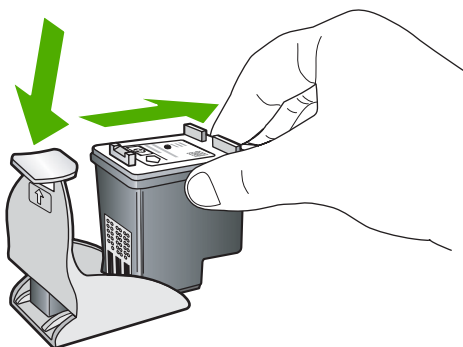

Remove ink from your skin and clothing

Follow these instructions to remove ink from your skin and clothing:

Surface	Remedy
Skin	Wash the area with an abrasive soap.
White fabric	Wash the fabric in <i>cold</i> water and use chlorine bleach.
Color fabric	Wash the fabric in <i>cold</i> water and use sudsy ammonia.

- △ **CAUTION:** Always use cold water to remove ink from fabric. Warm or hot water can set the ink into the fabric.

Ink-backup mode

Use the ink-backup mode to operate the HP All-in-One with only one print cartridge. The ink-backup mode is initiated when a print cartridge is removed from the print cartridge carriage. During ink-backup mode, the product can only print jobs from the computer. You cannot initiate a print job from the control panel (such as copying or printing from a memory card).

 **NOTE:** When the HP All-in-One operates in ink-backup mode, a message is displayed on screen. If the message is displayed and two print cartridges are installed in the product, verify that the protective piece of plastic tape has been removed from each print cartridge. When plastic tape covers the print cartridge contacts, the product cannot detect that the print cartridge is installed.

For more information about ink-backup mode, see the following topics:

- [Ink-backup mode output](#)
- [Exit ink-backup mode](#)

Ink-backup mode output

Printing in ink-backup mode slows the HP All-in-One and affects the quality of printouts.

Installed print cartridge	Result
Black print cartridge	Colors print as grayscale.
Tri-color print cartridge	Colors print but black is grayed and is not a true black.
Photo print cartridge	Colors print as grayscale.

 **NOTE:** HP does not recommend using the photo print cartridge for ink-backup mode.

Exit ink-backup mode

Install two print cartridges in the HP All-in-One to exit ink-backup mode.

Related topics

[“Replace the print cartridges” on page 99](#)

Advanced print cartridge maintenance

If you are experiencing problems with printing, you might have a problem with one or both of the print cartridges. You should perform the procedures in the following sections only when directed to do so for resolving print quality issues.

Performing the aligning and cleaning procedures unnecessarily can waste ink and shorten the life of the cartridges.

If you receive an error message about the print cartridges, see [“Print cartridge messages” on page 245](#) for more information.

This section contains the following topics:

- [Align the print cartridges](#)
- [Clean the print cartridges](#)
- [Clean the print cartridge contacts](#)
- [Clean the area around the ink nozzles](#)

Align the print cartridges

The product aligns the cartridges every time a new print cartridge is installed. You can also align the print cartridges to help resolve print quality issues. Aligning the print cartridges ensures high-quality output.

 **NOTE:** If you remove and reinstall the same print cartridge, the product will not prompt you to align the print cartridges. The product remembers the alignment values for that print cartridge, so you do not need to realign the print cartridges.

To align newly installed print cartridges

- ▲ When prompted, ensure plain white letter or A4 paper is loaded in the input tray, then press **OK**.

 **NOTE:** If you have colored paper loaded in the input tray when you align the print cartridges, the alignment will fail. Load unused plain white paper into the input tray, and then try the alignment again.

The product prints a test page, aligns the print cartridges, and calibrates the printer.

To align the print cartridges from the control panel at any time

1. Load letter, A4, or legal unused plain white paper into the input tray.
2. Press **Setup**.



3. Press the down arrow button or the up arrow button to highlight **Tools**, and press **OK**.
4. Press the down arrow button or the up arrow button to highlight **Align Print Cartridges**, and press **OK**.
5. The HP All-in-One prints a test page, aligns the print head, and calibrates the printer. Recycle or discard the page.

 **NOTE:** If you have colored paper loaded in the input tray when you align the printer, the alignment will fail. Load unused plain white paper into the input tray, and then try the alignment again.

A success or failure message appears.

6. Press **OK** to continue.

To align the print cartridges from the HP Photosmart Software

1. Load letter or A4 unused plain white paper into the input tray.

 **NOTE:** If you have colored paper loaded in the input tray when you align the print cartridges, the alignment will fail. Load unused plain white paper into the input tray, and then try the alignment again.

2. In the HP Solution Center, click **Settings**.
3. In the **Print Settings** area, click **Printer Toolbox**.

 **NOTE:** You can also open the **Printer Toolbox** from the **Print Properties** dialog box. In the **Print Properties** dialog box, click the **Features** tab, and then click **Printer Services**.

NOTE: You can also open the **Printer Toolbox** from the **Print Properties** dialog box. In the **Print Properties** dialog box, click the **Features** tab, and then click the **Printer Services** button.

The **Printer Toolbox** appears.

4. Click the **Device Services** tab.
5. Click **Align the Print Cartridges**.
6. When prompted, ensure plain white letter or A4 paper is loaded in the input tray, then press **OK**.

 **NOTE:** If you have colored paper loaded in the input tray when you align the print cartridges, the alignment will fail. Load unused plain white paper into the input tray, and then try the alignment again.

The product prints a print cartridge alignment sheet. Recycle or discard the page.

Clean the print cartridges

Use this feature when the self-test report shows streaking, white lines through any of the lines of color or when a color is muddy after installing a print cartridge for the first time. Do not clean print cartridges unnecessarily, as this wastes ink and shortens the life of the ink nozzles.

To clean the print cartridges from the control panel at any time

1. Load letter, A4, or legal unused plain white paper into the input tray.
2. Press **Setup**.



3. Press the down arrow button or the up arrow button to highlight **Tools**, and press **OK**.
4. Press the down arrow button or the up arrow button to highlight **Align Print Cartridges**, and press **OK**.

5. The product prints a test page, aligns the printhead, and calibrates the printer. Recycle or discard the page.



NOTE: If you have colored paper loaded in the input tray when you align the printer, the alignment will fail. Load unused plain white paper into the input tray, and then try the alignment again.

A success or failure message appears.

6. Press **OK** to continue.

To clean the print cartridges from the HP Photosmart Software

1. Load letter, A4, or legal unused plain white paper into the input tray.
2. In the HP Solution Center, click **Settings**.
3. In the **Print Settings** area, click **Printer Toolbox**.



NOTE: You can also open the **Printer Toolbox** from the **Print Properties** dialog box. In the **Print Properties** dialog box, click the **Features** tab, and then click **Printer Services**.

The **Printer Toolbox** appears.

4. Click the **Device Services** tab.
5. Click **Clean the Print Cartridges**.
6. Follow the prompts until you are satisfied with the quality of the output, and then click **Done**.
7. Follow the prompts until you are satisfied with the quality of the output, and then click **Done**.

There are three stages of cleaning. Each stage lasts from one to two minutes, uses one sheet of paper, and uses an increasing amount of ink. After each stage, review the quality of the printed page. You should only initiate the next phase of cleaning if the print quality is poor.

If print quality still seems poor after you clean the print cartridges, try cleaning the print cartridge contacts before replacing the affected print cartridge.

Related topics

- [“Clean the print cartridge contacts” on page 108](#)
- [“Replace the print cartridges” on page 99](#)

Clean the print cartridge contacts

-
- ⚠ **CAUTION:** Do not clean the print cartridge contacts unless you are having a problem with print quality and other measures have not been successful. For more information, see [“Print quality troubleshooting” on page 133](#).
-

Clean the print cartridge contacts if you get repeated messages on your computer screen prompting you to check a print cartridge after you already have cleaned or aligned the print cartridges.

Before cleaning the print cartridge contacts, remove the print cartridge and verify that nothing is covering the print cartridge contacts, then reinstall the print cartridge. If you continue to get messages to check the print cartridges, clean the print cartridge contacts.

Make sure you have the following materials available:

- Dry foam rubber swabs, lint-free cloth, or any soft material that will not come apart or leave fibers.

 **TIP:** Coffee filters are lint-free and work well for cleaning print cartridges.

- Distilled, filtered, or bottled water (tap water might contain contaminants that can damage the print cartridges).

 **CAUTION:** Do **not** use platen cleaners or alcohol to clean the print cartridge contacts. These can damage the print cartridge or the product.

To clean the print cartridge contacts

1. Make sure the product is turned on.

 **CAUTION:** If the product is turned off when you open the print cartridge door to access the print cartridges, it will not release the cartridges for changing. You might damage the product if the print cartridges are not docked safely when you try to remove them.

2. Open the print cartridge door.
The print carriage moves to the far right side of the product.

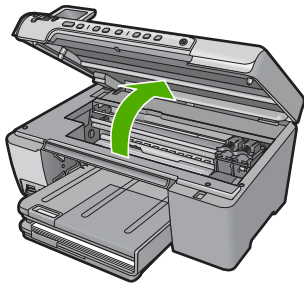

3. Wait until the print carriage is idle and silent, and then unplug the power cord from the back of the product.
4. Lightly press down on the print cartridge to release it, and then pull it towards you out of the slot.

 **NOTE:** Do not remove both print cartridges at the same time. Remove and clean each print cartridge one at a time. Do not leave a print cartridge outside the product for more than 30 minutes.

5. Inspect the print cartridge contacts for ink and debris buildup.
6. Dip a clean foam rubber swab or lint-free cloth into distilled water, and squeeze any excess water from it.
7. Hold the print cartridge by its sides.

8. Clean only the copper-colored contacts. Allow the print cartridges to dry for approximately ten minutes.

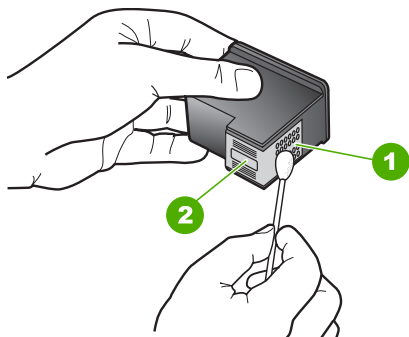

1	Copper-colored contacts
2	Ink nozzles (do not clean)

9. Hold the print cartridge with the HP logo on top, and insert the print cartridge back into the slot. Make sure you push the print cartridge in firmly until it snaps into place.

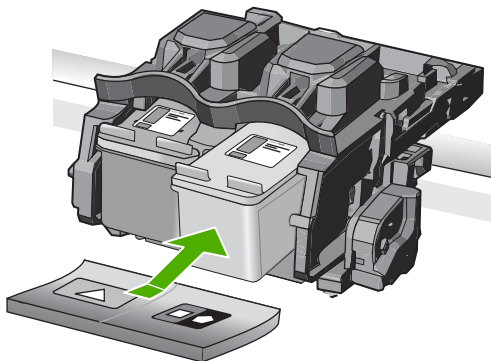

10. Repeat if necessary for the other print cartridge.
11. Gently close the print cartridge door and plug the power cord into the back of the product.

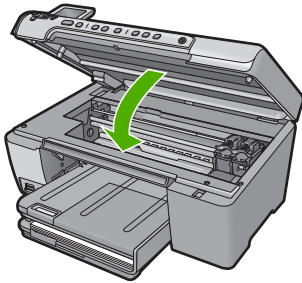

Related topics

- [“Clean the area around the ink nozzles” on page 111](#)
- [“Replace the print cartridges” on page 99](#)

Clean the area around the ink nozzles

If the product is used in a dusty environment, a small amount of debris might accumulate inside the product. This debris can include dust, hair, carpet, or clothing fibers. When debris gets on the print cartridges, it can cause ink streaks and smudges on printed pages. Ink streaking can be corrected by cleaning around the ink nozzles as described here.

 **NOTE:** Clean the area around the ink nozzles only if you continue to see streaks and smudges on your printed pages after you have already tried the automatic cleaning procedure from the Setup menu or the HP Photosmart software.

Make sure you have the following materials available:

- Dry foam rubber swabs, lint-free cloth, or any soft material that will not come apart or leave fibers.

 **TIP:** Coffee filters are lint-free and work well for cleaning print cartridges.

- Distilled, filtered, or bottled water (tap water might contain contaminants that can damage the print cartridges).

 **CAUTION:** Do not touch the copper-colored contacts or ink nozzles. Touching these parts can result in clogs, ink failure, and bad electrical connections.

To clean the area around the ink nozzles

1. Make sure the product is turned on.

△ **CAUTION:** If the product is turned off when you open the print cartridge door to access the print cartridges, it will not release the cartridges for changing. You might damage the product if the print cartridges are not docked safely when you try to remove them.

2. Open the print cartridge door.
The print carriage moves to the far right side of the product.

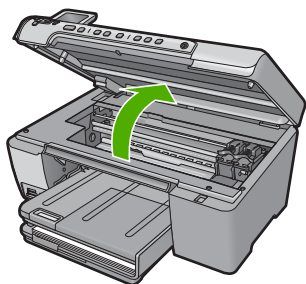

3. Wait until the print carriage is idle and silent, and then unplug the power cord from the back of the product.
4. Lightly press down on the print cartridge to release it, and then pull it towards you out of the slot.

📝 **NOTE:** Do not remove both print cartridges at the same time. Remove and clean each print cartridge one at a time. Do not leave a print cartridge outside the product for more than 30 minutes.

5. Place the print cartridge on a piece of paper with the ink nozzles facing up.
6. Lightly moisten a clean foam rubber swab with distilled water.

7. Clean the face and edges around the ink nozzle area with the swab, as shown below.

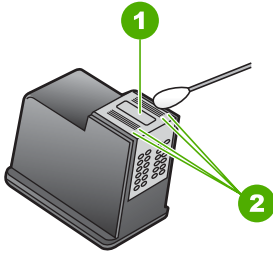

- | | |
|---|---|
| 1 | Nozzle plate (do not clean) |
| 2 | Face and edges around the ink nozzle area |

△ **CAUTION:** Do **not** clean the nozzle plate.

8. Hold the print cartridge with the HP logo on top, and insert the print cartridge back into the slot. Make sure you push the print cartridge in firmly until it snaps into place.

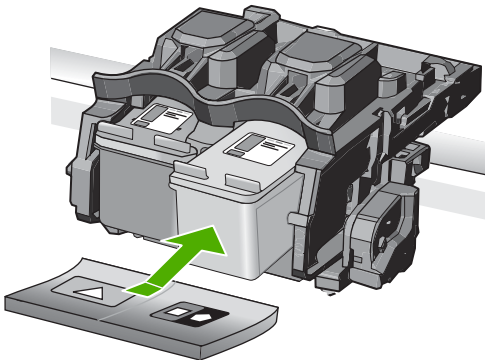

9. Repeat if necessary for the other print cartridge.
10. Gently close the print cartridge door and plug the power cord into the back of the product.

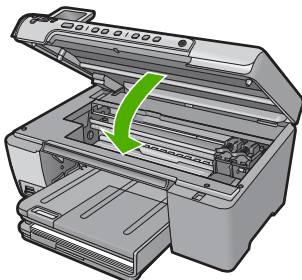

Related topics

[“Clean the print cartridges”](#) on page 107

Print a self-test report

If you are experiencing problems with printing, print a self-test report before you replace the print cartridges. This report provides useful information on several aspects of your product, including your print cartridges.

To print a self-test report

1. Load letter or A4 unused plain white paper into the input tray.
2. Press **Setup**.



3. Press the down arrow button to highlight **Tools**, and then press **OK**.
4. Press the down arrow button to highlight **Self-Test Report**, and then press **OK**.
The product prints a self-test report, which might indicate the source of the printing problem. A sample of the ink test area of the report is shown below.



5. Make sure the test patterns show a complete grid and the thick color lines are complete.
 - If more than a few lines in a pattern are broken, this might indicate a problem with the nozzles. You might need to clean the print cartridges.
 - If the black line is missing, faded, streaked, or shows lines, this might indicate a problem with the black or photo print cartridge in the right slot.
 - If any of the color lines are missing, faded, streaked, or show lines, this might indicate a problem with the tri-color print cartridge in the left slot.

Related topics

- “[Clean the print cartridges](#)” on page 107
- “[Replace the print cartridges](#)” on page 99
- “[Align the print cartridges](#)” on page 106

Clean the HP All-in-One

To ensure that your copies and scans remain clear, you might need to clean the glass and lid backing. You might also want to dust the exterior of the HP All-in-One.

 **TIP:** You can purchase an HP Cleaning Kit for Inkjet Printers and All-in-Ones (Q6260A) that provides everything needed to safely clean your HP device. For more information, go to: www.shopping.hp.com/accessories-store/printer.

This section contains the following topics:

- [Clean the glass](#)
- [Clean the lid backing](#)
- [Clean the exterior](#)

Clean the glass

Fingerprints, smudges, hair, and dust on the main glass surface slow down performance and affect the accuracy of the copy and scan features.

To clean the glass

1. Turn off the product, unplug the power cord, and raise the lid.
2. Clean the glass with a soft cloth or sponge slightly moistened with a nonabrasive glass cleaner.

 **CAUTION:** Do not use abrasives, acetone, benzene, or carbon tetrachloride on the glass, since they can damage it. Do not place or spray liquid directly on the glass. The liquid might seep under the glass and damage the product.

3. Dry the glass with a dry, soft, lint-free cloth to prevent spotting.
4. Turn on the product.

Clean the lid backing

Minor debris can accumulate on the white document backing located underneath the lid of the HP All-in-One.

To clean the lid backing

1. Turn off the product, unplug the power cord, and raise the lid.
2. Clean the white document backing with a soft cloth or sponge slightly moistened with a mild soap and warm water.
Wash the backing gently to loosen debris. Do not scrub the backing.

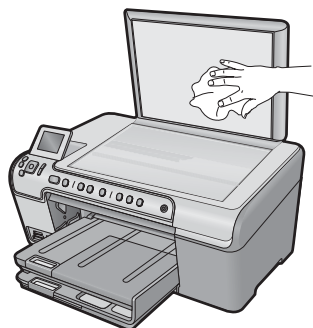

3. Dry the backing with a dry, soft, lint-free cloth.

△ **CAUTION:** Do not use paper-based wipes, as these might scratch the backing.

4. If further cleaning is needed, repeat the previous steps using isopropyl (rubbing) alcohol, and wipe the backing thoroughly with a damp cloth to remove any residual alcohol.

△ **CAUTION:** Be careful not to spill alcohol on the glass or exterior of the product, as this might damage it.

5. Plug in the power cord, and then turn on the product.

Clean the exterior

Use a soft cloth or slightly moistened sponge to wipe dust, smudges, and stains off the case. The interior of the HP All-in-One does not require cleaning. Keep fluids away from the control panel and the interior of the HP All-in-One.

△ **CAUTION:** To avoid damage to the exterior of the HP All-in-One, do not use alcohol or alcohol-based cleaning products.

Turn off the HP All-in-One

To avoid damaging the product, you must properly shut it down by using the On button located on the product. Wait until the On light turns off before you unplug the power cord or turn off a power strip.

13 Shop for ink supplies

For a list of print cartridge numbers, see the printed documentation that came with the HP All-in-One. You can also use the software that came with the HP All-in-One to find out the reorder number for all the print cartridges. You can order print cartridges online from the HP Web site. Additionally, you can contact a local HP reseller to find out the correct print cartridge reorder numbers for your product and purchase print cartridges.

To order genuine HP supplies for the HP All-in-One, go to www.hp.com/buy/supplies. If prompted, choose your country/region, follow the prompts to select your product, and then click one of the shopping links on the page.

 **NOTE:** Ordering print cartridges online is not supported in all countries/regions. If it is not supported in your country/region, contact a local HP reseller for information about purchasing print cartridges.

To order print cartridges from your desktop

- ▲ Click the **Shop for HP Supplies** icon on your desktop to connect to HP SureSupply. You will see a list of original HP printing supplies that are compatible with your product, as well as options to conveniently purchase the supplies you need (options vary by country/region).

If you deleted this icon from your desktop, click the **Start** menu, point to the **HP** folder, then click **Shop for Supplies**.

To order print cartridges through the HP Photosmart Software

1. In the HP Solution Center, click **Settings**, point to **Print Settings**, and then click **Printer Toolbox**.

 **NOTE:** You can also open the **Printer Toolbox** from the **Print Properties** dialog box. In the **Print Properties** dialog box, click the **Features** tab, and then click the **Printer Services** button.

2. Click the **Estimated Ink Levels** tab.
3. Click **Print Cartridge Ordering Information**.
The print cartridge reorder numbers appear.
4. Click **Order Online**.
HP sends detailed printer information, including model number, serial number, and ink supply levels, to an authorized online reseller. The supplies you need are preselected; you can change quantities, add or remove items, and then check out.

14 Troubleshooting

This section contains the following topics:

- [View the Readme file](#)
- [Setup troubleshooting](#)
- [Paper jams](#)
- [Print quality troubleshooting](#)
- [Print troubleshooting](#)
- [Memory card troubleshooting](#)
- [Scan troubleshooting](#)
- [Copy troubleshooting](#)
- [CD/DVD print troubleshooting](#)
- [Errors](#)

View the Readme file

You might want to refer to the Readme file for information on system requirements and possible installation problems.

You can access the Readme file by clicking **Start**, pointing to **Programs** or **All Programs**, pointing to **HP**, pointing to **Photosmart C5500 All-in-One series**, and then clicking **Readme**.

You can access the Readme file by double-clicking the icon located in the top-level folder of the HP All-in-One software CD-ROM.

Setup troubleshooting

This section contains setup troubleshooting information for the product.

Many issues are caused when the product is connected to the computer using a USB cable before the HP Photosmart software is installed on the computer. If you connected the product to your computer before the software installation screen prompts you to do so, you must follow these steps:

Troubleshooting common setup issues

1. Disconnect the USB cable from the computer.
2. Uninstall the software (if you have already installed it).
For more information, see "[Uninstall and reinstall the software](#)" on page 130.
3. Restart your computer.
4. Turn off the product, wait one minute, then restart it.
5. Reinstall the HP Photosmart software.

△ **CAUTION:** Do not connect the USB cable to the computer until prompted by the software installation screen.

This section contains the following topics:

- [The product will not turn on](#)
- [I connected the USB cable, but I am having problems using the product with my computer](#)
- [After setting up the product, it does not print](#)
- [The display shows the wrong language](#)
- [The wrong measurements are showing in menus on the display](#)
- [When I insert the CD-ROM into my computer's CD-ROM drive, nothing happens](#)
- [The Minimum System Checks screen appears](#)
- [A red X appears on the USB connect prompt](#)
- [I received a message that an Unknown Error has occurred](#)
- [The registration screen does not appear](#)
- [Uninstall and reinstall the software](#)

The product will not turn on

Try the following solutions if there are no light indications, no noise, and no movement from the product when you turn it on.

- [Solution 1: Make sure you use the power cord that came with the product](#)
- [Solution 2: Reset the product](#)
- [Solution 3: Press the On button more slowly](#)
- [Solution 4: Contact HP to replace the power supply](#)
- [Solution 5: Contact HP support for service](#)

Solution 1: Make sure you use the power cord that came with the product

Solution:

- Make sure the power cord is firmly connected to both the product and the power adapter. Plug the power cord into a power outlet, surge protector, or power strip.

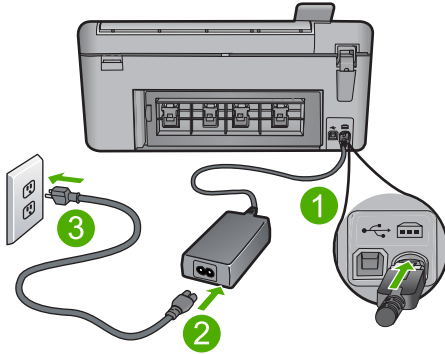

1	Power connection
2	Power cord and adapter
3	Power outlet

- If you are using a power strip, make sure the power strip is turned on. Or, try plugging the product directly into a power outlet.
- Test the power outlet to make sure it is working. Plug in an appliance that you know works, and see if the appliance has power. If not, then there might be a problem with the power outlet.
- If you plugged the product into a switched outlet, make sure the outlet is switched on. If it is switched to on but still does not work, then there might be a problem with the power outlet.

Cause: The product was not being used with the power cord provided.

If this did not solve the issue, try the next solution.

Solution 2: Reset the product

Solution: Turn off the product, and then unplug the power cord. Plug the power cord back in, and then press the On button to turn on the product.

Cause: The product experienced an error.

If this did not solve the issue, try the next solution.

Solution 3: Press the On button more slowly

Solution: The product might not respond if you press the On button too quickly. Press the On button once. It might take a few minutes for the product to turn on. If you press the On button again during this time, you might turn the product off.

△ **CAUTION:** If the product still does not turn on, it might have a mechanical failure. Unplug the product from the power outlet.

Contact HP support for service.

Go to: www.hp.com/support. If prompted, choose your country/region, and then click **Contact HP** for information on calling for technical support.

Cause: You pressed the On button too quickly.

If this did not solve the issue, try the next solution.

Solution 4: Contact HP to replace the power supply

Solution: Contact HP support to request a power supply for the product.

Go to: www.hp.com/support.

If prompted, choose your country/region, and then click **Contact HP** for information on calling for technical support.

Cause: The power supply was not intended for use with this product.

If this did not solve the issue, try the next solution.

Solution 5: Contact HP support for service

Solution: If you have completed all of the steps provided in the previous solutions and are still having a problem, contact HP support for service.

Go to: www.hp.com/support.

If prompted, choose your country/region, and then click **Contact HP** for technical support.

Cause: You might need assistance to enable the product or software to function properly.

I connected the USB cable, but I am having problems using the product with my computer

Solution: You must first install the software that came with the product before connecting the USB cable. During installation, do not plug in the USB cable until prompted by the onscreen instructions.

Once you have installed the software, connecting your computer to the product with a USB cable is straightforward. Simply plug one end of the USB cable into the back

of your computer and the other into the back of the product. You can connect to any USB port on the back of your computer.

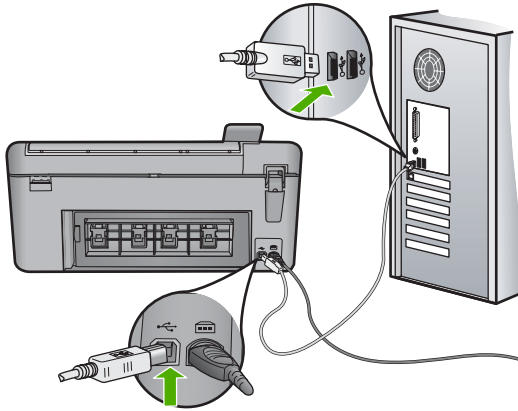

For more information on installing the software and connecting the USB cable, see the Start Here guide that came with the product.

Cause: The USB cable was connected before the software was installed. Connecting the USB cable before you are prompted can cause errors.

After setting up the product, it does not print

Try the following solutions to resolve the issue. Solutions are listed in order, with the most likely solution first. If the first solution does not solve the problem, continue trying the remaining solutions until the issue is resolved.

- [Solution 1: Check the connection between the product and computer](#)
- [Solution 2: Check that the ink cartridges are installed properly and have ink](#)
- [Solution 3: Press the On button to turn on the product](#)
- [Solution 4: Load paper in the input tray](#)

Solution 1: Check the connection between the product and computer

Solution: Check the connection between the product and computer.

Cause: The product and computer were not communicating with each other.

If this did not solve the issue, try the next solution.

Solution 2: Check that the ink cartridges are installed properly and have ink

Solution: Check that the ink cartridges are installed properly and have ink.

For more information, see:

[“Work with print cartridges” on page 97](#)

Cause: There might have been a problem with one or more of the ink cartridges.

If this did not solve the issue, try the next solution.

Solution 3: Press the On button to turn on the product

Solution: Look at the display on the product. If the display is blank and the On button is not lit, the product is turned off. Make sure the power cord is firmly connected to the product and plugged into a power outlet. Press the On button to turn on the product.

Cause: The product might not have been turned on.

If this did not solve the issue, try the next solution.

Solution 4: Load paper in the input tray

Solution: Load paper in the input tray.

For more information, see:

[“Load paper” on page 37](#)

Cause: The product might have been out of paper.

The display shows the wrong language

Solution: Change the language setting.

 **NOTE:** You will be prompted to set both the language and the country/region settings, by using the following procedure.

To set your language and country/region

1. Press **Setup**.



2. Press the down arrow button to highlight **Preferences**, and then press **OK**.
3. Press the down arrow button to highlight **Set Language**, and then press **OK**.
4. Press the down arrow button to scroll through the languages. When the language you want to use is highlighted, press **OK**.
5. When prompted, press the down arrow button to highlight **Yes** for confirmation, and then press **OK**.
The **Preferences** menu reappears.
6. Press the down arrow button to highlight **Set Country/Region**, and then press **OK**.

7. Press the down arrow button to scroll through the countries/regions. When the country/region you want to use is highlighted, press **OK**.
8. When prompted, press the down arrow button to highlight **Yes** for confirmation, and then press **OK**.

Cause: You might have selected the incorrect language when setting up the product.

The wrong measurements are showing in menus on the display

Solution: Change the country/region setting.

 **NOTE:** You will be prompted to set both the language and the country/region settings, by using the following procedure.

To set your language and country/region

1. Press **Setup**.



2. Press the down arrow button to highlight **Preferences**, and then press **OK**.
3. Press the down arrow button to highlight **Set Language**, and then press **OK**.
4. Press the down arrow button to scroll through the languages. When the language you want to use is highlighted, press **OK**.
5. When prompted, press the down arrow button to highlight **Yes** for confirmation, and then press **OK**.
The **Preferences** menu reappears.
6. Press the down arrow button to highlight **Set Country/Region**, and then press **OK**.
7. Press the down arrow button to scroll through the countries/regions. When the country/region you want to use is highlighted, press **OK**.
8. When prompted, press the down arrow button to highlight **Yes** for confirmation, and then press **OK**.

Cause: You might have selected the incorrect country/region when setting up the product. The country/region you select determines the paper sizes shown on the display.

When I insert the CD-ROM into my computer's CD-ROM drive, nothing happens

Solution: If the installation does not run automatically, you can start it manually.

To start the installation from a Windows computer

1. From the Windows **Start** menu, click **Run** (or click **Accessories**, and then **Run**).
2. In the **Run** dialog box, enter **d:\setup.exe**, and then click **OK**.

If your CD-ROM drive is not assigned to drive letter D, enter the appropriate drive letter.

Cause: The installation failed to run automatically.

The Minimum System Checks screen appears

Solution: Click **Details** to see what the specific problem is, and then correct the problem before attempting to install the software.

Cause: Your system did not meet the minimum requirements to install the software.

A red X appears on the USB connect prompt

Solution: Check that the product is turned on, and then try the USB connection again.

To retry the USB connection

1. Verify that the USB cable is set up properly as follows:
 - Unplug the USB cable and plug it in again or try plugging the USB cable into a different USB port.
 - Do not attach the USB cable to a keyboard.
 - Verify that the USB cable is 3 meters (9.8 feet) or less in length.
 - If you have several USB devices attached to your computer, you might want to unplug the other devices during the installation.
2. Unplug the product power cord, and then plug it in again.

3. Verify that the USB cable and power cord are plugged in.

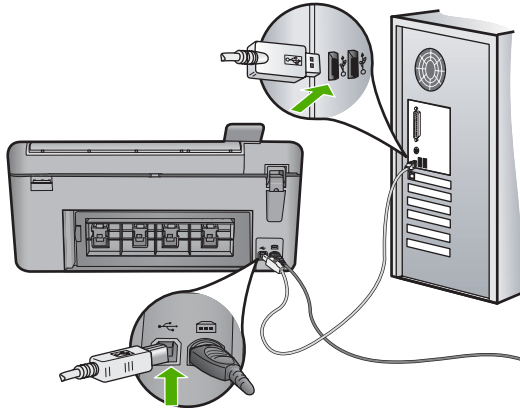

4. Click **Retry** to retry the connection.
 5. Continue with the installation and restart the computer when prompted.
- Cause:** The USB connection between the product and the computer failed.

I received a message that an Unknown Error has occurred

Solution: Uninstall the software completely, and then reinstall it.

To uninstall the software and reset the product

1. Disconnect and reset the product.

To disconnect and reset the product

- a. Make sure the product is turned on.
 - b. Press the On button to turn off the product.
 - c. Disconnect the power cord from the back of the product.
 - d. Reconnect the power cord to the back of the product.
 - e. Press the On button to turn on the product.
2. Uninstall the software completely.



NOTE: It is important that you follow the uninstall procedure carefully to ensure you have removed the software completely from the computer, before reinstalling it.

To uninstall the software completely

- a. On the Windows taskbar, click **Start, Settings, Control Panel**, (or just **Control Panel**).
- b. Double-click **Add/Remove Programs** (or click **Uninstall a program**).

- c. Remove all the items that are related to the HP Photosmart Software.

△ **CAUTION:** If the computer is manufactured by HP or Compaq, **do not** remove any applications other than those listed below.

- HP Imaging device functions
 - HP Document Viewer
 - HP Photosmart Essential
 - HP Image Zone
 - HP Photo and imaging gallery
 - HP Photosmart, Officejet, Deskjet (with the product name and software version number)
 - HP Software update
 - HP Share to Web
 - HP Solution Center
 - HP Director
 - HP Memories Disk Greeting Card Creator 32
- d. Go to C:\Program Files\HP or C:\Program Files\Hewlett-Packard (for some older products) and delete the Digital Imaging folder.
- e. Go to C:\WINDOWS and rename the twain_32 folder to twain_32 old.
3. Turn off programs that run in the background.

 **NOTE:** When the computer is turned on, a software group called the Terminate and Stay Resident (TSR) programs automatically loads. These programs activate some of the computer utilities, such as the anti-virus software, but are not required for the computer to function. Occasionally, TSR's prevent the HP software from loading so that it does not install properly. In Windows Vista and Windows XP, use the MSCONFIG utility to prevent TSR programs and services from starting up.

To turn off programs that run in the background

- a. On the Windows taskbar, click **Start**.
- b. Depending on your operating system, do one of the following:
 - In Windows Vista: In **Start Search**, type **MSCONFIG**, and then press **Enter**.
When the User Account Control dialog box appears, click **Continue**.
 - In Windows XP: Click **Run**. When the **Run** dialog box appears, type **MSCONFIG**, and then press **Enter**.
The **MSCONFIG** utility application appears.
- c. Click the **General** tab.
- d. Click **Selective Startup**.
- e. If there is a check mark next to **Load Startup Items**, click the check mark to remove it.
- f. Click the **Services** tab, and select the **Hide All Microsoft Services** box.
- g. Click **Disable all**.

- h. Click **Apply**, and then click **Close**.

 **NOTE:** If you receive a message stating **Access is denied** while making changes, click **OK** and continue. The message will not prevent you from making the changes.

- i. Click **Restart** to apply the changes to the computer during the next restart. After the computer restarts, the **You've used system configuration utility to make changes to the way windows starts** message appears.
- j. Click the check box next to **Do not show this message again**.
4. Run the **Disk Cleanup** utility to delete temporary files and folders.

To run the Disk Cleanup utility

- a. On the Windows taskbar, click **Start**, click **Programs** or **All Programs**, and then click **Accessories**.
- b. Click **System Tools**, and then click **Disk Cleanup**.
The **Disk Cleanup** analyzes the hard drive and then presents a report with a list of components to delete.
- c. Select the appropriate check boxes to remove the unnecessary components.

More information about the Disk Cleanup utility

The Disk Cleanup utility frees hard disk space on your computer by doing the following:

- Deleting temporary Internet files
 - Deleting downloaded program files
 - Emptying the Recycle Bin
 - Deleting files from your temporary folder
 - Deleting files created by other Windows tools
 - Removing optional Windows components that you do not use
- d. After selecting the components to remove, click **OK**.
5. Install the software.

To install the software

- a. Insert software CD into the CD-ROM drive of the computer.
The software installation will start automatically.

 **NOTE:** If the installation does not run automatically, from the Windows **Start** menu, click **Start Search** (or **Run**). In the **Start Search** (or **Run** dialog box), type `d:\setup.exe`, and then press **Enter**. (If your CD-ROM drive is not assigned to drive letter D, enter the appropriate drive letter.)

- b. Follow the prompts on the computer screen to install the software.
6. Try using the product again.

Cause: The source of the error was unknown.

The registration screen does not appear

Solution: You can access the registration (Sign up now) screen from the Windows taskbar by clicking **Start**, pointing to **Programs** or **All Programs**, **HP**, **Photosmart C5500 All-in-One series**, and then clicking **Product Registration**.

Cause: The registration screen did not launch automatically.

The registration screen did not launch automatically.

Uninstall and reinstall the software

If your installation is incomplete, or if you connected the USB cable to the computer before prompted by the software installation screen, you might need to uninstall and then reinstall the software. Do not simply delete the HP All-in-One application files from your computer. Make sure to remove them properly using the uninstall utility provided when you installed the software that came with the HP All-in-One.

To uninstall and reinstall the software

1. On the Windows taskbar, click **Start**, **Settings**, **Control Panel** (or just **Control Panel**).
2. Double-click **Add/Remove Programs** (or click **Uninstall a program**).
3. Select **HP Photosmart All-In-One Driver Software**, and then click **Change/Remove**.
Follow the onscreen instructions.
4. Disconnect the product from your computer.
5. Restart your computer.

 **NOTE:** It is important that you disconnect the product before restarting your computer. Do not connect the product to your computer until after you have reinstalled the software.

6. Insert the product CD-ROM into your computer's CD-ROM drive and then start the Setup program.

 **NOTE:** If the Setup program does not appear, locate the setup.exe file on the CD-ROM drive and double-click it.

NOTE: If you no longer have the installation CD, you can download the software from www.hp.com/support.

7. Follow the onscreen instructions and the instructions provided in the Start Here guide that came with the product.

When the software installation is complete, the **HP Digital Imaging Monitor** icon appears in the Windows system tray.

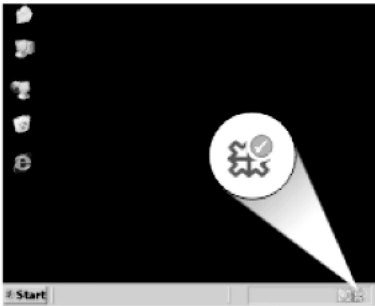

Paper jams

To help avoid paper jams, follow these guidelines:

- Remove printed papers from the output tray frequently.
- Prevent curled or wrinkled photo paper by storing all unused photo paper flat in a resealable bag.
- Ensure that paper loaded in the input tray lays flat and the edges are not bent or torn.
- Do not combine different paper types and paper sizes in the input tray; the entire stack of paper in the input tray must be the same size and type.
- Adjust the paper-width guide in the input tray to fit snugly against all paper. Make sure the paper-width guide does not bend the paper in the input tray.
- Do not force paper too far forward in the input tray.
- Use paper types that are recommended for the product.

This section contains the following topics:

- [Clear paper jams](#)
- [Information on paper](#)

Clear paper jams

Solution: In case of a paper jam, check the rear door. You might need to clear the paper jam from the rear door.

To clear a paper jam from the rear door

1. Press in the tab on the left side of the rear door to release the door. Remove the door by pulling it away from the product.

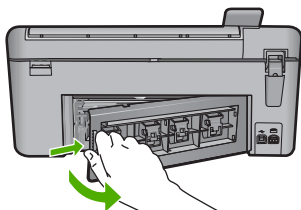

2. Gently pull the paper out of the rollers.

△ **CAUTION:** If the paper tears when you are removing it from the rollers, check the rollers and wheels for torn pieces of paper that might be remaining inside the product. If you do not remove all the pieces of paper from the product, more paper jams are likely to occur.

3. Replace the rear door. Gently push the door forward until it snaps into place.

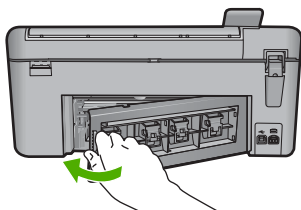

4. Press **OK** on the control panel to continue the current job.

Cause: Paper had jammed in the product.

Information on paper

The HP All-in-One is designed to work well with most paper types. Test a variety of paper types before buying a large quantity. Find a paper type that works well and is easy to purchase. HP papers are designed for the best quality results. In addition, follow these tips:

- Do not use paper that is too thin, that has a slick texture, or that stretches easily. It can feed incorrectly through the paper path, causing paper jams.
- Store photo media in its original packaging inside a resealable plastic bag on a flat surface in a cool, dry place. When you are ready to print, remove only the paper you plan to use immediately. When you have finished printing, return any unused photo paper to the plastic bag.
- Do not leave unused photo paper in the input tray. The paper might start to curl, which might reduce the quality of your printouts. Curled paper can also cause paper jams.

- Always hold photo paper by the edges. Fingerprints on photo paper can reduce print quality.
- Do not use paper that is heavily textured. It can cause graphics or text to print improperly.
- Do not combine different paper types and paper sizes in the input tray; the entire stack of paper in the input tray must be the same size and type.
- Store printed photos under glass or in a storage book to prevent bleeding over time from high humidity.

Print quality troubleshooting

Use this section to solve these print quality problems:

- [Wrong, inaccurate, or bleeding colors](#)
- [Ink is not filling the text or graphics completely](#)
- [The printout has a horizontal band of distortion near the bottom of a borderless print](#)
- [Printouts have horizontal streaks or lines](#)
- [Printouts are faded or have dull colors](#)
- [Printouts seem blurry or fuzzy](#)
- [Printouts have vertical streaks](#)
- [Printouts are slanted or skewed](#)
- [Ink streaks on the back of the paper](#)
- [Paper is not picked up from the input tray](#)
- [The text edges are jagged](#)

Wrong, inaccurate, or bleeding colors

If your printout has one of the following print quality problems, try the solutions in this section for help.

- Colors look different than what you expected.
For example, the colors in your graphic or photo look one way on your computer screen but print out differently, or magenta was replaced with cyan in your printout.
- Colors run into each other, or look like they are smeared on the page. The edges might have a feathering appearance instead of being sharp and defined.

Try the following solutions if the colors appear wrong, inaccurate, or bleed into each other.

- [Solution 1: Make sure you are using genuine HP print cartridges](#)
- [Solution 2: Make sure paper is loaded correctly in the input tray](#)
- [Solution 3: Check the paper type](#)
- [Solution 4: Check to see if the product is in ink-backup mode](#)
- [Solution 5: Check the print settings](#)
- [Solution 6: Clean or replace the print cartridges](#)

Solution 1: Make sure you are using genuine HP print cartridges

Solution: Check to see if your print cartridges are genuine HP print cartridges.

HP recommends that you use genuine HP print cartridges. Genuine HP print cartridges are designed and tested with HP printers to help you easily produce great results, time after time.

 **NOTE:** HP cannot guarantee the quality or reliability of non-HP supplies. Printer service or repairs required as a result of using a non-HP supply will not be covered under warranty.

If you believe you purchased genuine HP print cartridges, go to:

www.hp.com/go/anticounterfeit

Cause: Non-HP print cartridges were being used.

If this did not solve the issue, try the next solution.

Solution 2: Make sure paper is loaded correctly in the input tray

Solution: Make sure the paper is loaded correctly and that it is not wrinkled or too thick.

- Load paper with the side you want to print on facing down. For example, if you are loading glossy photo paper, load the paper with the glossy side down.
- Make sure the paper lays flat in the input tray and is not wrinkled. If the paper is too close to the printhead during printing, the ink might be smeared. This can happen if the paper is raised, wrinkled, or very thick, such as a mailing envelope.

For more information, see:

[“Load paper” on page 37](#)

Cause: The paper was loaded incorrectly, or it was wrinkled or too thick.

If this did not solve the issue, try the next solution.

Solution 3: Check the paper type

Solution: HP recommends that you use HP papers or any other paper type that is appropriate for the product.

Always make sure the paper you are printing on is flat. For best results when printing images, use HP Advanced Photo Paper.

Store photo media in its original packaging inside a resealable plastic bag on a flat surface in a cool, dry place. When you are ready to print, remove only the paper you plan to use immediately. When you have finished printing, return any unused photo paper to the plastic bag. This will prevent the photo paper from curling.

 **NOTE:** There is no problem with the ink supplies and replacing the print cartridges is unnecessary.

For more information, see:

- [“Recommended papers for printing and copying” on page 34](#)
- [“Information on paper” on page 132](#)

Cause: The wrong kind of paper was loaded in the input tray.

If this did not solve the issue, try the next solution.

Solution 4: Check to see if the product is in ink-backup mode

Solution: Check to see if the the product is printing in ink-backup mode, with only one print cartridge installed.

If the product is in ink-backup mode, text and photo quality will differ from those printed when using both print cartridges.

If you are satisfied with the print quality, continue printing in ink-backup mode. Or, replace the missing print cartridge.

For more information, see:

- [“Ink-backup mode” on page 105](#)
- [“Replace the print cartridges” on page 99](#)

Cause: A print cartridge was missing and the product was printing in ink-backup mode.

If this did not solve the issue, try the next solution.

Solution 5: Check the print settings

Solution: Check the print settings.

- Check the print settings to see if the color settings are incorrect.
For example, check to see if the document is set to print in grayscale. Or, check to see if advanced color settings such as saturation, brightness, or color tone, are set to modify the appearance of colors.
- Check the print quality setting and make sure it matches the type of paper loaded in the product.
You might need to choose a lower print quality setting, if colors are running into each other. Or, choose a higher setting if you are printing a high-quality photo, and then make sure photo paper such as HP Premium Photo Papers, is loaded in the input tray.

 **NOTE:** On some computer screens, colors might appear differently than they do when printed on paper. In this case, there is nothing wrong with the product, print settings, or print cartridges. No further troubleshooting is required.

For more information, see:

- [“Change the print speed or quality” on page 54](#)
- [“Recommended papers for printing and copying” on page 34](#)

Cause: The print settings were set incorrectly.

If this did not solve the issue, try the next solution.

Solution 6: Clean or replace the print cartridges

Solution: Check the estimated ink levels in the print cartridges.



NOTE: Ink level warnings and indicators provide estimates for planning purposes only. When you receive a low-ink warning message, consider having a replacement cartridge available to avoid possible printing delays. You do not need to replace the print cartridges until print quality becomes unacceptable.

If there is ink remaining in the print cartridges, but you are still noticing a problem, print a self-test report to determine if there is a problem with the print cartridges. If the self-test report shows a problem, clean the print cartridges. If the problem persists, you might need to replace the print cartridges.

For more information, see:

- [“Check the estimated ink levels” on page 98](#)
- [“Print a self-test report” on page 114](#)
- [“Clean the print cartridges” on page 107](#)

Cause: The print cartridges needed to be cleaned or there was insufficient ink.

Ink is not filling the text or graphics completely

Try the following solutions if the ink is not filling the text or image completely so that it appears that parts are missing or blank.

- [Solution 1: Check the print settings](#)
- [Solution 2: Check the paper type](#)
- [Solution 3: Make sure you are using genuine HP print cartridges](#)
- [Solution 4: Check the print cartridges](#)
- [Solution 5: Replace the print cartridge](#)

Solution 1: Check the print settings

Solution: Check the print settings.

- Check the paper type setting to make sure it matches the type of paper loaded in the input tray.
- Check the quality setting. Use a higher quality setting to increase the amount of ink used for printing.

For more information, see:

- [“Set the paper type for printing” on page 53](#)
- [“Change the print speed or quality” on page 54](#)
- [“Print using Maximum dpi” on page 60](#)
- [“Change copy speed or quality” on page 88](#)

Cause: The paper type or print quality settings were set incorrectly.

If this did not solve the issue, try the next solution.

Solution 2: Check the paper type

Solution: HP recommends that you use HP papers or any other paper type that is appropriate for the product.

Always make sure the paper you are printing on is flat. For best results when printing images, use HP Advanced Photo Paper.

Store photo media in its original packaging inside a resealable plastic bag on a flat surface in a cool, dry place. When you are ready to print, remove only the paper you plan to use immediately. When you have finished printing, return any unused photo paper to the plastic bag. This will prevent the photo paper from curling.

 **NOTE:** There is no problem with the ink supplies and replacing the print cartridges is unnecessary.

For more information, see:

- [“Recommended papers for printing and copying” on page 34](#)
- [“Information on paper” on page 132](#)

Cause: The wrong kind of paper was loaded in the input tray.

If this did not solve the issue, try the next solution.

Solution 3: Make sure you are using genuine HP print cartridges

Solution: Check to see if your print cartridges are genuine HP print cartridges.

HP recommends that you use genuine HP print cartridges. Genuine HP print cartridges are designed and tested with HP printers to help you easily produce great results, time after time.

 **NOTE:** HP cannot guarantee the quality or reliability of non-HP supplies. Printer service or repairs required as a result of using a non-HP supply will not be covered under warranty.

If you believe you purchased genuine HP print cartridges, go to:

www.hp.com/go/anticounterfeit

Cause: Non-HP print cartridges were being used.

If this did not solve the issue, try the next solution.

Solution 4: Check the print cartridges

Solution: Check the estimated ink levels in the print cartridges.

 **NOTE:** Ink level warnings and indicators provide estimates for planning purposes only. When you receive a low-ink warning message, consider having a replacement cartridge available to avoid possible printing delays. You do not need to replace the print cartridges until print quality becomes unacceptable.

If there is ink remaining in the print cartridges, but you are still noticing a problem, print a self-test report to determine if there is a problem with the print cartridges. If the

self-test report shows a problem, clean the print cartridges. If the problem persists, you might need to replace the print cartridges.

For more information, see:

- [“Check the estimated ink levels” on page 98](#)
- [“Print a self-test report” on page 114](#)
- [“Clean the print cartridges” on page 107](#)

Cause: The print cartridges needed to be cleaned or there was insufficient ink. If this did not solve the issue, try the next solution.

Solution 5: Replace the print cartridge

Solution: Replace the indicated print cartridge. You can also remove the indicated print cartridge and print using ink-backup mode.

Check to see if your print cartridge is still under warranty and end of warranty date has not been reached.

- If the end of warranty date has been reached, purchase a new print cartridge.
- If the end of warranty date has not been reached, contact HP support. Go to www.hp.com/support. If prompted, choose your country/region, and then click **Contact HP** for information on calling for technical support.

Cause: The print cartridge was damaged.

The printout has a horizontal band of distortion near the bottom of a borderless print

Try the following solutions if your borderless print has a blurry band or line on the bottom of it.

- [Solution 1: Check the paper type](#)
- [Solution 2: Use a higher print quality setting](#)
- [Solution 3: Rotate the image](#)

Solution 1: Check the paper type

Solution: HP recommends that you use HP papers or any other paper type that is appropriate for the product.

Always make sure the paper you are printing on is flat. For best results when printing images, use HP Advanced Photo Paper.

Store photo media in its original packaging inside a resealable plastic bag on a flat surface in a cool, dry place. When you are ready to print, remove only the paper you plan to use immediately. When you have finished printing, return any unused photo paper to the plastic bag. This will prevent the photo paper from curling.

 **NOTE:** There is no problem with the ink supplies and replacing the print cartridges is unnecessary.

For more information, see:

- [“Recommended papers for printing and copying”](#) on page 34
- [“Information on paper”](#) on page 132

Cause: The wrong kind of paper was loaded in the input tray.

If this did not solve the issue, try the next solution.

Solution 2: Use a higher print quality setting

Solution: Check the quality setting. Use a higher quality setting to increase the amount of ink used for printing.

 **NOTE:** For maximum dpi resolution, go to the **Advanced** tab, and then select **Enabled** from the **Maximum dpi** drop-down list.

For more information, see:

- [“Change the print speed or quality”](#) on page 54
- [“Print using Maximum dpi”](#) on page 60
- [“Change copy speed or quality”](#) on page 88

Cause: The print quality setting was set too low.

If this did not solve the issue, try the next solution.

Solution 3: Rotate the image

Solution: If the problem persists, use the software you installed with the product or another software application to rotate your image 180 degrees so that the light blue, gray, or brown hues in your image do not print at the bottom of the page.

For more information, see:

[“Change the page orientation”](#) on page 54

Cause: The photo image had odd hues printed near the bottom of the page.

Printouts have horizontal streaks or lines

Try the following solutions if your printout has lines, streaks, or marks on it that run across the width of the page.

- [Solution 1: Make sure the paper is loaded correctly](#)
- [Solution 2: Use a higher print quality setting](#)
- [Solution 3: If the print cartridge was dropped, wait for it to recover](#)
- [Solution 4: Clean the print cartridge nozzles](#)
- [Solution 5: Check the print cartridges](#)
- [Solution 6: Replace the print cartridge](#)

Solution 1: Make sure the paper is loaded correctly

Solution: Make sure that the paper is loaded correctly in the input tray.

For more information, see:

[“Load paper” on page 37](#)

Cause: The paper was not loaded correctly.

If this did not solve the issue, try the next solution.

Solution 2: Use a higher print quality setting

Solution: Check the quality setting. Use a higher quality setting to increase the amount of ink used for printing.



NOTE: For maximum dpi resolution, go to the **Advanced** tab, and then select **Enabled** from the **Maximum dpi** drop-down list.

For more information, see:

- [“Change the print speed or quality” on page 54](#)
- [“Print using Maximum dpi” on page 60](#)
- [“Change copy speed or quality” on page 88](#)

Cause: The print quality setting was set too low.

If this did not solve the issue, try the next solution.

Solution 3: If the print cartridge was dropped, wait for it to recover

Solution: Allow 30 minutes for the print cartridge to recover.

Cause: A tri-color or photo print cartridge was jarred or handled roughly during installation.

If this did not solve the issue, try the next solution.

Solution 4: Clean the print cartridge nozzles

Solution: Check the print cartridges. If it looks as though there are fibers or dust around the ink nozzles, clean the ink nozzle area of the print cartridge.

For more information, see:

[“Clean the area around the ink nozzles” on page 111](#)

Cause: The print cartridge nozzles needed to be cleaned.

If this did not solve the issue, try the next solution.

Solution 5: Check the print cartridges

Solution: Check the estimated ink levels in the print cartridges.



NOTE: Ink level warnings and indicators provide estimates for planning purposes only. When you receive a low-ink warning message, consider having a replacement cartridge available to avoid possible printing delays. You do not need to replace the print cartridges until print quality becomes unacceptable.

If there is ink remaining in the print cartridges, but you are still noticing a problem, print a self-test report to determine if there is a problem with the print cartridges. If the self-test report shows a problem, clean the print cartridges. If the problem persists, you might need to replace the print cartridges.

For more information, see:

- [“Check the estimated ink levels” on page 98](#)
- [“Print a self-test report” on page 114](#)
- [“Clean the print cartridges” on page 107](#)

Cause: The print cartridges needed to be cleaned or there was insufficient ink. If this did not solve the issue, try the next solution.

Solution 6: Replace the print cartridge

Solution: Replace the indicated print cartridge. You can also remove the indicated print cartridge and print using ink-backup mode.

Check to see if your print cartridge is still under warranty and end of warranty date has not been reached.

- If the end of warranty date has been reached, purchase a new print cartridge.
- If the end of warranty date has not been reached, contact HP support. Go to www.hp.com/support. If prompted, choose your country/region, and then click **Contact HP** for information on calling for technical support.

Cause: The print cartridge was damaged.

Printouts are faded or have dull colors

Try the following solutions if the colors in your printout are not as bright and intense as you expected.

- [Solution 1: Check the print settings](#)
- [Solution 2: Check the paper type](#)
- [Solution 3: If you are making a copy, place a protective sheet on the glass](#)
- [Solution 4: Clean the glass](#)
- [Solution 5: Check the print cartridges](#)
- [Solution 6: Replace the print cartridge](#)

Solution 1: Check the print settings

Solution: Check the print settings.

- Check the paper type setting to make sure it matches the type of paper loaded in the input tray.
- Check the quality setting. Use a higher quality setting to increase the amount of ink used for printing.

For more information, see:

- [“Set the paper type for printing” on page 53](#)
- [“Change the print speed or quality” on page 54](#)
- [“Print using Maximum dpi” on page 60](#)
- [“Change copy speed or quality” on page 88](#)

Cause: The paper type or print quality settings were set incorrectly.

If this did not solve the issue, try the next solution.

Solution 2: Check the paper type

Solution: HP recommends that you use HP papers or any other paper type that is appropriate for the product.

Always make sure the paper you are printing on is flat. For best results when printing images, use HP Advanced Photo Paper.

Store photo media in its original packaging inside a resealable plastic bag on a flat surface in a cool, dry place. When you are ready to print, remove only the paper you plan to use immediately. When you have finished printing, return any unused photo paper to the plastic bag. This will prevent the photo paper from curling.

For more information, see:

- [“Recommended papers for printing and copying” on page 34](#)
- [“Information on paper” on page 132](#)

Cause: The wrong kind of paper was loaded in the input tray.

If this did not solve the issue, try the next solution.

Solution 3: If you are making a copy, place a protective sheet on the glass

Solution: If you are making a copy, try placing one or more clear plastic sheet protectors directly on the glass, and then place the original print side down on top of the sheet protectors.

Cause: The quality of the original was poor.

If this did not solve the issue, try the next solution.

Solution 4: Clean the glass

Solution: Clean the glass and lid backing.

For more information, see:

- “[Clean the lid backing](#)” on page 115
- “[Clean the glass](#)” on page 115

Cause: Debris might be stuck on the glass or on the back of the document lid; this causes poor copy quality and slows down processing.

If this did not solve the issue, try the next solution.

Solution 5: Check the print cartridges

Solution: Check the estimated ink levels in the print cartridges.

 **NOTE:** Ink level warnings and indicators provide estimates for planning purposes only. When you receive a low-ink warning message, consider having a replacement cartridge available to avoid possible printing delays. You do not need to replace the print cartridges until print quality becomes unacceptable.

If there is ink remaining in the print cartridges, but you are still noticing a problem, print a self-test report to determine if there is a problem with the print cartridges. If the self-test report shows a problem, clean the print cartridges. If the problem persists, you might need to replace the print cartridges.

For more information, see:

- “[Check the estimated ink levels](#)” on page 98
- “[Print a self-test report](#)” on page 114
- “[Clean the print cartridges](#)” on page 107

Cause: The print cartridges needed to be cleaned or there was insufficient ink.

If this did not solve the issue, try the next solution.

Solution 6: Replace the print cartridge

Solution: Replace the indicated print cartridge. You can also remove the indicated print cartridge and print using ink-backup mode.

Check to see if your print cartridge is still under warranty and end of warranty date has not been reached.

- If the end of warranty date has been reached, purchase a new print cartridge.
- If the end of warranty date has not been reached, contact HP support. Go to www.hp.com/support. If prompted, choose your country/region, and then click **Contact HP** for information on calling for technical support.

Cause: The print cartridge was damaged.

Printouts seem blurry or fuzzy

Try the following solutions if your printout is not sharp or unclear.

 **TIP:** After reviewing the solutions in this section, you can go to HP's Web site to see if there is additional troubleshooting help. For more information, go to: www.hp.com/support.

- [Solution 1: Check the print settings](#)
- [Solution 2: Use a higher quality image](#)
- [Solution 3: Print the image in a smaller size](#)

Solution 1: Check the print settings

Solution: Check the print settings.

- Check the paper type setting to make sure it matches the type of paper loaded in the input tray.
- Check the quality setting. Use a higher quality setting to increase the amount of ink used for printing.

For more information, see:

- [“Set the paper type for printing” on page 53](#)
- [“Change the print speed or quality” on page 54](#)
- [“Print using Maximum dpi” on page 60](#)
- [“Change copy speed or quality” on page 88](#)

Cause: The paper type or print quality settings were set incorrectly.

If this did not solve the issue, try the next solution.

Solution 2: Use a higher quality image

Solution: Use a higher resolution image.

If you are printing a photo or graphic, and the resolution is too low, it will be blurry or fuzzy when printed.

If a digital photo or rasterized graphic has been resized, it can be blurry or fuzzy when printed.

Cause: The resolution of the image was low.

If this did not solve the issue, try the next solution.

Solution 3: Print the image in a smaller size

Solution: Reduce the size of the image and then print it.

If you are printing a photo or graphic, and the print size is set too high, it will be blurry or fuzzy when printed.

If a digital photo or rasterized graphic has been resized, it can be blurry or fuzzy when printed.

Cause: The image was printed in a larger size.

Printouts have vertical streaks

Solution: HP recommends that you use HP papers or any other paper type that is appropriate for the product.

Always make sure the paper you are printing on is flat. For best results when printing images, use HP Advanced Photo Paper.

Store photo media in its original packaging inside a resealable plastic bag on a flat surface in a cool, dry place. When you are ready to print, remove only the paper you plan to use immediately. When you have finished printing, return any unused photo paper to the plastic bag. This will prevent the photo paper from curling.

 **NOTE:** There is no problem with the ink supplies and replacing the print cartridges is unnecessary.

For more information, see:

- [“Recommended papers for printing and copying” on page 34](#)
- [“Information on paper” on page 132](#)

Cause: The wrong kind of paper was loaded in the input tray.

Printouts are slanted or skewed

Try the following solutions if your printout does not appear straight on the page.

- [Solution 1: Make sure the paper is loaded correctly](#)
- [Solution 2: Make sure only one type of paper is loaded](#)
- [Solution 3: Ensure that the rear door is securely installed](#)

Solution 1: Make sure the paper is loaded correctly

Solution: Make sure that the paper is loaded correctly in the input tray.

For more information, see:

[“Load paper” on page 37](#)

Cause: The paper was not loaded correctly.

If this did not solve the issue, try the next solution.

Solution 2: Make sure only one type of paper is loaded

Solution: Load only one type of paper at a time.

Cause: More than one type of paper was loaded in the input tray.

If this did not solve the issue, try the next solution.

Solution 3: Ensure that the rear door is securely installed

Solution: Make sure that the rear door is securely installed.

If you removed the rear door to clear a paper jam, replace it. Gently push the door forward until it snaps into place.

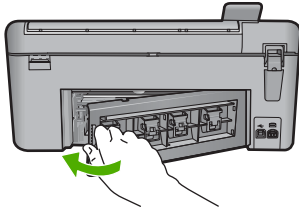

Cause: The rear door was not securely installed.

Ink streaks on the back of the paper

Try the following solutions if there is smeared ink on the back of your printout.

- [Solution 1: Print on a page of plain paper](#)
- [Solution 2: Wait while the ink dries](#)

Solution 1: Print on a page of plain paper

Solution: Print one or several pages of plain paper to soak up any excess ink in the product.

To remove excess ink using plain paper

1. Load several sheets of plain paper in the input tray.
2. Wait five minutes.
3. Print a document with little or no text.
4. Check the back of the paper for ink. If there is still ink on the back of the paper, try printing on another page of plain paper.

Cause: Ink accumulated inside the product, where the back of the paper rests during printing.

If this did not solve the issue, try the next solution.

Solution 2: Wait while the ink dries

Solution: Wait at least thirty minutes for the ink inside the product to dry, then try the print job again.

Cause: The excess ink in the product needed to dry out.

Paper is not picked up from the input tray

Try the following solutions to resolve the issue. Solutions are listed in order, with the most likely solution first. If the first solution does not solve the problem, continue trying the remaining solutions until the issue is resolved.

- [Solution 1: Make sure the paper is loaded correctly](#)
- [Solution 2: Check the print settings](#)
- [Solution 3: Clean the rollers](#)
- [Solution 4: Contact HP support for service](#)

Solution 1: Make sure the paper is loaded correctly

Solution: Make sure that the paper is loaded correctly in the input tray.

For more information, see:

[“Load paper” on page 37](#)

Cause: The paper was not loaded correctly.

If this did not solve the issue, try the next solution.

Solution 2: Check the print settings

Solution: Check the print settings.

- Check the paper type setting to make sure it matches the type of paper loaded in the input tray.
- Check the quality setting. Use a higher quality setting to increase the amount of ink used for printing.

For more information, see:

- [“Set the paper type for printing” on page 53](#)
- [“Change the print speed or quality” on page 54](#)
- [“Print using Maximum dpi” on page 60](#)
- [“Change copy speed or quality” on page 88](#)

Cause: The paper type or print quality settings were set incorrectly.

If this did not solve the issue, try the next solution.

Solution 3: Clean the rollers

Solution: Clean the rollers.

Make sure you have the following materials available:

- A lint-free cloth, or any soft material that will not come apart or leave fibers.
- Distilled, filtered, or bottled water (tap water might contain contaminants that can damage the print cartridges).

To clean the rollers

1. Turn off the product and remove the power cord.
2. Press in the tab on the left side of the rear door to release the door. Remove the door by pulling it away from the product.

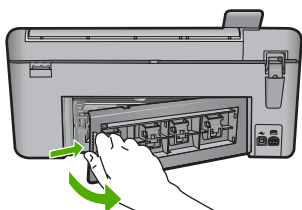

3. Dip the lint-free cloth into the purified or distilled water, and squeeze any excess water from it.
4. Clean the rubber rollers to remove any dust or dirt buildup.
5. Replace the rear door. Gently push the door forward until it snaps into place.
6. Plug the power cord back in, and turn on the product.
7. Try to print again.

Cause: The rollers were dirty and needed to be cleaned.

If this did not solve the issue, try the next solution.

Solution 4: Contact HP support for service

Solution: If you have completed all of the steps provided in the previous solutions and are still having a problem, contact HP support for service.

Go to: www.hp.com/support.

If prompted, choose your country/region, and then click **Contact HP** for technical support.

Cause: You might need assistance to enable the product or software to function properly.

The text edges are jagged

Try the following solutions if the text in your printouts is not sharp and the edges are rough.

- [Solution 1: Use TrueType or OpenType fonts](#)
- [Solution 2: Align the print cartridges](#)

Solution 1: Use TrueType or OpenType fonts

Solution: Use TrueType or OpenType fonts to ensure that the product is able to print smooth fonts. When selecting a font, look for the TrueType or OpenType icon.



TrueType icon



OpenType icon

Cause: The font was a custom size.

Some software applications offer custom fonts that have jagged edges when enlarged or printed. Also, if you want to print bitmapped text, it might have jagged edges when enlarged or printed.

If this did not solve the issue, try the next solution.

Solution 2: Align the print cartridges

Solution: Align the print cartridges.

For more information, see:

[“Align the print cartridges” on page 106](#)

Cause: The print cartridges needed to be aligned.

Print troubleshooting

Use this section to solve these printing problems:

- [Envelopes print incorrectly](#)
- [Borderless printing produces unexpected results](#)
- [The product is not responding](#)
- [The product prints meaningless characters](#)
- [Nothing happens when I try to print](#)
- [The pages in my document came out in the wrong order](#)
- [The margins are not printing as expected](#)
- [Text or graphics are cut off at the edge of the page](#)
- [A blank page came out while printing](#)
- [Ink is spraying the inside of the product when I print a photo](#)

Envelopes print incorrectly

Try the following solutions to resolve the issue. Solutions are listed in order, with the most likely solution first. If the first solution does not solve the problem, continue trying the remaining solutions until the issue is resolved.

- [Solution 1: Load the stack of envelopes correctly](#)
- [Solution 2: Check the envelope type](#)
- [Solution 3: Tuck the flaps to avoid paper jams](#)

Solution 1: Load the stack of envelopes correctly

Solution: Load a stack of envelopes in the input tray, with the envelope flaps facing up and to the left.

Make sure that you remove all paper from the input tray before loading the envelopes.

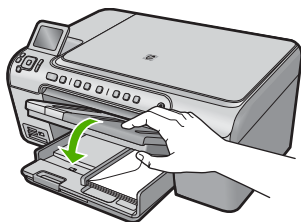

For more information, see:

[“Load envelopes” on page 42](#)

Cause: A stack of envelopes was loaded incorrectly.

If this did not solve the issue, try the next solution.

Solution 2: Check the envelope type

Solution: Do not use shiny or embossed envelopes or envelopes that have clasps or windows.

Cause: The wrong type of envelope was loaded.

If this did not solve the issue, try the next solution.

Solution 3: Tuck the flaps to avoid paper jams

Solution: To avoid paper jams, tuck the flaps inside the envelopes.

Cause: The flaps might get caught in the rollers.

Borderless printing produces unexpected results

Solution: Try printing the image from the photo imaging software that came with the product.

Cause: Printing a borderless image from a non-HP software application produced unexpected results.

The product is not responding

Try the following solutions to resolve the issue. Solutions are listed in order, with the most likely solution first. If the first solution does not solve the problem, continue trying the remaining solutions until the issue is resolved.

- [Solution 1: Turn on the product](#)
- [Solution 2: Load paper in the input tray](#)
- [Solution 3: Select the correct printer](#)
- [Solution 4: Check the printer driver status](#)
- [Solution 5: Wait until the product completes the current operation](#)
- [Solution 6: Remove all cancelled print jobs from the queue](#)
- [Solution 7: Clear the paper jam](#)
- [Solution 8: Make sure the print carriage can move freely](#)
- [Solution 9: Check the connection from the product to your computer](#)
- [Solution 10: Reset the product](#)

Solution 1: Turn on the product

Solution: Look at the On light located on the product. If it is not lit, the product is turned off. Make sure the power cord is firmly connected to the product and plugged into a power outlet. Press the On button to turn on the product.

Cause: The product was turned off.

If this did not solve the issue, try the next solution.

Solution 2: Load paper in the input tray

Solution: Load paper in the input tray.

For more information, see:

[“Load paper” on page 37](#)

Cause: The product was out of paper.

If this did not solve the issue, try the next solution.

Solution 3: Select the correct printer

Solution: Make sure you have selected the correct printer in your software application.

 **TIP:** You can set the product as the default printer to ensure that the printer is automatically selected when you select **Print** in the **File** menu of your different software applications.

Cause: The product was not the selected printer.

If this did not solve the issue, try the next solution.

Solution 4: Check the printer driver status

Solution: The printer driver status might have changed to either **offline** or **stop printing**.

To check the printer driver status

▲ In the HP Solution Center, click the **Status** tab.

Cause: The status of the printer driver had changed.

If this did not solve the issue, try the next solution.

Solution 5: Wait until the product completes the current operation

Solution: If the product is performing another task such as copying or scanning, your print job will be delayed until the product completes the current task.

Some documents take a long time to print. If nothing has printed several minutes after you sent a print job to the product, check the product display to see if there are any messages.

Cause: The product was busy with another task.

If this did not solve the issue, try the next solution.

Solution 6: Remove all cancelled print jobs from the queue

Solution: A print job might remain in the queue after it has been cancelled. The cancelled print job jams the queue and prevents the next print job from printing.

From your computer, open the printer folder and see if the cancelled job remains in the print queue. Try to delete the job from the queue. If the print job remains in the queue, try one or both of the following:

- Disconnect the USB cable from the product, restart the computer, and then reconnect the USB cable to the product.
- Shut down the product, restart the computer, and then restart the product.

Cause: A deleted print job was in the queue.

If this did not solve the issue, try the next solution.

Solution 7: Clear the paper jam

Solution: Clear the paper jam.

For more information, see:

[“Clear paper jams” on page 131](#)

Cause: The product had a paper jam.

If this did not solve the issue, try the next solution.

Solution 8: Make sure the print carriage can move freely

Solution: Unplug the power cable if it is not already unplugged. Check to see if the print cartridge carriage will move freely from one side of the printer to the other. Do not try to force it to move if it is hung up on something.

△ **CAUTION:** Be careful not to force the print cartridge carriage. If the carriage is stuck, forcing it to move will damage the printer.

For more information, see:

[“Carriage stall” on page 245](#)

Cause: The print carriage had stalled.

If this did not solve the issue, try the next solution.

Solution 9: Check the connection from the product to your computer

Solution: Check the connection from the product to your computer. Verify that the USB cable is securely plugged into the USB port on the back of the product. Make sure the other end of the USB cable is plugged into a USB port on your computer. After the cable is connected properly, turn off the product and then on again. If the product is connected to the computer through a Bluetooth connection, make sure that the connection is active and the product is turned on.

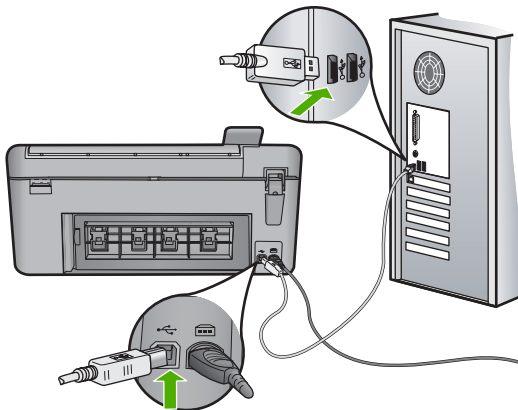

If the connections are secure, and nothing has printed several minutes after you sent a print job to the product, check the status of the product. In the HP Photosmart Software, click **Settings**, and then click **Status**.

Cause: The computer was not communicating with the product.

If this did not solve the issue, try the next solution.

Solution 10: Reset the product

Solution: Turn off the product, and then unplug the power cord. Plug the power cord back in, and then press the On button to turn on the product.

Cause: The product experienced an error.

The product prints meaningless characters

Try the following solutions to resolve the issue. Solutions are listed in order, with the most likely solution first. If the first solution does not solve the problem, continue trying the remaining solutions until the issue is resolved.

- [Solution 1: Reset the product](#)
- [Solution 2: Print a previously saved version of the document](#)

Solution 1: Reset the product

Solution: Turn off the product and your computer for 60 seconds, then turn them both on and try printing again.

Cause: There was no available memory in the product.

If this did not solve the issue, try the next solution.

Solution 2: Print a previously saved version of the document

Solution: Try printing another document from the same software application. If this works, then try printing a previously saved version of the document that is not corrupt.

Cause: The document was corrupt.

Nothing happens when I try to print

Try the following solutions to resolve the issue. Solutions are listed in order, with the most likely solution first. If the first solution does not solve the problem, continue trying the remaining solutions until the issue is resolved.

- [Solution 1: Turn on the product](#)
- [Solution 2: Load paper in the input tray](#)
- [Solution 3: Select the correct printer](#)
- [Solution 4: Check the printer driver status](#)
- [Solution 5: Wait until the product completes the current operation](#)
- [Solution 6: Remove all cancelled print jobs from the queue](#)
- [Solution 7: Clear the paper jam](#)
- [Solution 8: Make sure the print carriage can move freely](#)
- [Solution 9: Check the connection from the product to your computer](#)
- [Solution 10: Reset the product](#)

Solution 1: Turn on the product

Solution: Look at the On light located on the product. If it is not lit, the product is turned off. Make sure the power cord is firmly connected to the product and plugged into a power outlet. Press the On button to turn on the product.

Cause: The product was turned off.

If this did not solve the issue, try the next solution.

Solution 2: Load paper in the input tray

Solution: Load paper in the input tray.

For more information, see:

[“Load paper” on page 37](#)

Cause: The product was out of paper.

If this did not solve the issue, try the next solution.

Solution 3: Select the correct printer

Solution: Make sure you have selected the correct printer in your software application.

 **TIP:** You can set the product as the default printer to ensure that the printer is automatically selected when you select **Print** in the **File** menu of your different software applications.

Cause: The product was not the selected printer.

If this did not solve the issue, try the next solution.

Solution 4: Check the printer driver status

Solution: The printer driver status might have changed to either **offline** or **stop printing**.

To check the printer driver status

▲ In the HP Solution Center, click the **Status** tab.

Cause: The status of the printer driver had changed.

If this did not solve the issue, try the next solution.

Solution 5: Wait until the product completes the current operation

Solution: If the product is performing another task such as copying or scanning, your print job will be delayed until the product completes the current task.

Some documents take a long time to print. If nothing has printed several minutes after you sent a print job to the product, check the product display to see if there are any messages.

Cause: The product was busy with another task.

If this did not solve the issue, try the next solution.

Solution 6: Remove all cancelled print jobs from the queue

Solution: A print job might remain in the queue after it has been cancelled. The cancelled print job jams the queue and prevents the next print job from printing.

From your computer, open the printer folder and see if the cancelled job remains in the print queue. Try to delete the job from the queue. If the print job remains in the queue, try one or both of the following:

- Disconnect the USB cable from the product, restart the computer, and then reconnect the USB cable to the product.
- Shut down the product, restart the computer, and then restart the product.

Cause: A deleted print job was in the queue.

If this did not solve the issue, try the next solution.

Solution 7: Clear the paper jam

Solution: Clear the paper jam.

For more information, see:

[“Clear paper jams” on page 131](#)

Cause: The product had a paper jam.

If this did not solve the issue, try the next solution.

Solution 8: Make sure the print carriage can move freely

Solution: Unplug the power cable if it is not already unplugged. Check to see if the print cartridge carriage will move freely from one side of the printer to the other. Do not try to force it to move if it is hung up on something.

△ **CAUTION:** Be careful not to force the print cartridge carriage. If the carriage is stuck, forcing it to move will damage the printer.

For more information, see:

[“Carriage stall” on page 245](#)

Cause: The print carriage had stalled.

If this did not solve the issue, try the next solution.

Solution 9: Check the connection from the product to your computer

Solution: Check the connection from the product to your computer. Verify that the USB cable is securely plugged into the USB port on the back of the product. Make sure the other end of the USB cable is plugged into a USB port on your computer. After the cable is connected properly, turn off the product and then on again. If the product is connected to the computer through a Bluetooth connection, make sure that the connection is active and the product is turned on.

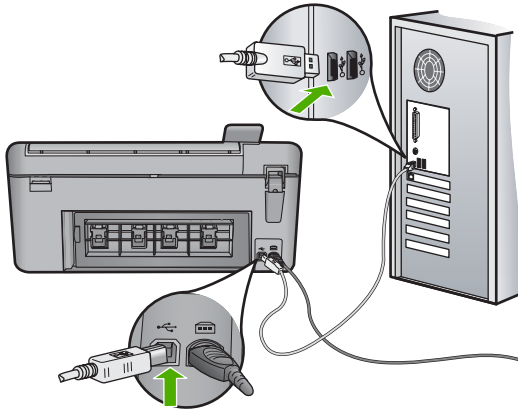

If the connections are secure, and nothing has printed several minutes after you sent a print job to the product, check the status of the product. In the HP Photosmart Software, click **Settings**, and then click **Status**.

Cause: The computer was not communicating with the product.

If this did not solve the issue, try the next solution.

Solution 10: Reset the product

Solution: Turn off the product, and then unplug the power cord. Plug the power cord back in, and then press the On button to turn on the product.

Cause: The product experienced an error.

The pages in my document came out in the wrong order

Solution: Print the document in reverse order. When the document finishes printing, the pages will be in correct order.

For more information, see:

[“Print a multiple-page document in reverse order”](#) on page 65

Cause: The print settings were set to print the first page of your document first. Because of the way the paper feeds through the product, the first page will be print side up at the bottom of the stack.

The margins are not printing as expected

Try the following solutions to resolve the issue. Solutions are listed in order, with the most likely solution first. If the first solution does not solve the problem, continue trying the remaining solutions until the issue is resolved.

- [Solution 1: Check the printer margins](#)
- [Solution 2: Verify the paper size setting](#)
- [Solution 3: Load the stack of paper correctly](#)
- [Solution 4: Load a stack of envelopes correctly in the input tray](#)

Solution 1: Check the printer margins

Solution: Check the printer margins.

Make sure the margin settings for the document do not exceed the printable area of the product.

To check your margin settings

1. Preview your print job before sending it to the product.
In most software applications, click the **File** menu, and then click **Print Preview**.
2. Check the margins.
The product uses the margins you have set in your software application, as long as they are greater than the minimum margins the product supports. For more information about setting margins in your software application, see the documentation that came with the software.
3. Cancel the print job if the margins are not satisfactory, and then adjust the margins in your software application.

Cause: The margins were not set correctly in your software application.

If this did not solve the issue, try the next solution.

Solution 2: Verify the paper size setting

Solution: Verify that you have selected the proper paper size setting for your project. Make sure that you have loaded the correct paper size in the input tray.

Cause: The paper size setting might not have been set correctly for the project you were printing.

If this did not solve the issue, try the next solution.

Solution 3: Load the stack of paper correctly

Solution: Remove the stack of paper from the input tray, reload the paper, and then slide the paper width guide inward until it stops at the edge of the paper.

For more information, see:

[“Load envelopes” on page 42](#)

Cause: The paper guides were not positioned correctly.

If this did not solve the issue, try the next solution.

Solution 4: Load a stack of envelopes correctly in the input tray

Solution: Load a stack of envelopes in the input tray, with the envelope flaps facing up and to the left.

Make sure that you remove all paper from the input tray before loading the envelopes.

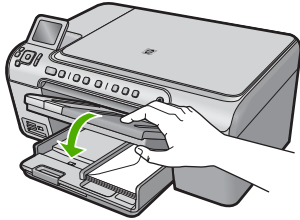

For more information, see:

[“Load envelopes” on page 42](#)

Cause: A stack of envelopes was loaded incorrectly.

Text or graphics are cut off at the edge of the page

Try the following solutions to resolve the issue. Solutions are listed in order, with the most likely solution first. If the first solution does not solve the problem, continue trying the remaining solutions until the issue is resolved.

- [Solution 1: Check the margin settings](#)
- [Solution 2: Check the layout of the document](#)
- [Solution 3: Load the stack of papers correctly](#)
- [Solution 4: Try printing with borders](#)

Solution 1: Check the margin settings

Solution: Check the printer margins.

Make sure the margin settings for the document do not exceed the printable area of the product.

To check your margin settings

1. Preview your print job before sending it to the product.
In most software applications, click the **File** menu, and then click **Print Preview**.
2. Check the margins.
The product uses the margins you have set in your software application, as long as they are greater than the minimum margins the product supports. For more information about setting margins in your software application, see the documentation that came with the software.
3. Cancel the print job if the margins are not satisfactory, and then adjust the margins in your software application.

Cause: The margins were not set correctly in your software application.

If this did not solve the issue, try the next solution.

Solution 2: Check the layout of the document

Solution: Make sure the layout of the document you are trying to print fits on a paper size supported by the product.

To preview the print layout

1. Load the correct paper size into the input tray.
2. Preview your print job before sending it to the product.
In most software applications, click the **File** menu, and then click **Print Preview**.
3. Check the graphics in the document to make sure that the current size fits within the printable area of the product.
4. Cancel the print job if the graphics do not fit in the printable area of the page.

 **TIP:** Some software applications allow you to scale the document to fit the paper size currently selected. Additionally, you can scale the size of a document from the print **Properties** dialog box.

Cause: The size of the document you were printing was larger than the paper loaded in the input tray.

If this did not solve the issue, try the next solution.

Solution 3: Load the stack of papers correctly

Solution: If the paper is misfeeding, it could cause parts of the document to cut off. Remove the stack of paper from the input tray, and then reload the paper.

For more information, see:

[“Load paper” on page 37](#)

Cause: The paper was loaded incorrectly.

If this did not solve the issue, try the next solution.

Solution 4: Try printing with borders

Solution: Try printing with borders by turning off the borderless option.

For more information, see:

[“Print a borderless image” on page 58](#)

Cause: Borderless printing was enabled. By selecting the **Borderless** option, your printed photo was enlarged and centered to fit the printable area of the page. Depending on the relative sizes of the digital photo and the paper on which you are printing, this could result in some parts of the image being cropped.

A blank page came out while printing

Try the following solutions to resolve the issue. Solutions are listed in order, with the most likely solution first. If the first solution does not solve the problem, continue trying the remaining solutions until the issue is resolved.

- [Solution 1: Remove any extra pages or lines at the end of the document](#)
- [Solution 2: Load paper in the input tray](#)
- [Solution 3: Check the print cartridge](#)

Solution 1: Remove any extra pages or lines at the end of the document

Solution: Open the document file in your software application and remove any extra pages or lines at the end of the document.

Cause: The document you were printing contained an additional blank page.

If this did not solve the issue, try the next solution.

Solution 2: Load paper in the input tray

Solution: If the product has only a few sheets remaining, load more paper in the input tray. If there is plenty of paper in the input tray, remove the paper, tap the stack of paper against a flat surface, and reload the paper into the input tray.

For more information, see:

[“Load paper” on page 37](#)

Cause: The product picked up two sheets of paper.

If this did not solve the issue, try the next solution.

Solution 3: Check the print cartridge

Solution: Check each print cartridge. The tape might have been removed from the copper-colored contacts, but still might cover the ink nozzles. If the tape is still

covering the ink nozzles, carefully remove the tape from the print cartridges. Do not touch the ink nozzles or the copper-colored contacts.

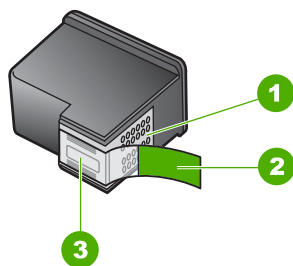

1	Copper-colored contacts
2	Plastic tape with pink pull tab (must be removed before installing)
3	Ink nozzles under tape



Cause: The protective plastic tape was only partially removed from the print cartridge.

Ink is spraying the inside of the product when I print a photo

Solution: Make sure you load photo paper in the input tray before you print a borderless print job.

For more information, see:

[“Load full-size paper or small-size photo paper” on page 37](#)

Cause: You were using the wrong paper type. The borderless print settings require you to print on photo paper.

Memory card troubleshooting

Use this section to solve these memory card problems:

- [My memory card no longer works in my digital camera](#)
- [The Photo light next to the memory card slots is blinking](#)
- [The Attention light blinks when I insert my memory card or storage device](#)
- [The product does not read the memory card](#)

- [The photos on the memory card do not transfer to my computer](#)
- [Photos in a connected digital camera with PictBridge do not print](#)

My memory card no longer works in my digital camera

Solution: Reformat your memory card in your camera or format your memory card on a Windows computer by selecting the FAT format. For more information, see the documentation that came with your digital camera.

Cause: You formatted the card on a Windows XP computer. By default, Windows XP formats a memory card of 8 MB or less and 64 MB or more with the FAT32 format. Digital cameras and other products use the FAT (FAT16 or FAT12) format and cannot recognize a FAT32 formatted card.

The Photo light next to the memory card slots is blinking

Solution: Do not pull out the memory card while the Photo light is flashing. A flashing light means the product is accessing the memory card. Wait until the light remains solid. Removing a memory card while it is being accessed might corrupt information on the card or damage the product and card.

For more information, see:

[“Insert a memory card” on page 71](#)

Cause: The product was reading the memory card.

The Attention light blinks when I insert my memory card or storage device

Try the following solutions to resolve the issue. Solutions are listed in order, with the most likely solution first. If the first solution does not solve the problem, continue trying the remaining solutions until the issue is resolved.

- [Solution 1: Remove and reinsert the memory card](#)
- [Solution 2: Remove the additional memory card](#)

Solution 1: Remove and reinsert the memory card

Solution: Remove and reinsert the memory card. You might have inserted it incorrectly. Turn the memory card so that the label faces up and the contacts are facing the product, and then push the card forward into the appropriate slot until the Photo light turns on.

If the problem continues, the memory card might be defective.

For more information, see:

[“Insert a memory card” on page 71](#)

Cause: The product detected an error with the memory card.

If this did not solve the issue, try the next solution.

Solution 2: Remove the additional memory card

Solution: Remove one of the memory cards. You can use only one memory card at a time.

For more information, see:

[“Insert a memory card” on page 71](#)

Cause: You had inserted more than one memory card.

The product does not read the memory card

Try the following solutions to resolve the issue. Solutions are listed in order, with the most likely solution first. If the first solution does not solve the problem, continue trying the remaining solutions until the issue is resolved.

- [Solution 1: Insert the memory card properly](#)
- [Solution 2: Insert the memory card fully into the appropriate slot on the product](#)
- [Solution 3: Remove the additional memory card](#)
- [Solution 4: Reformat the memory card in your digital camera](#)

Solution 1: Insert the memory card properly

Solution: Turn the memory card so that the label faces up and the contacts are facing the product, and then push the card forward into the appropriate slot until the Photo light turns on.

If the memory card is not inserted properly, the product will not respond and the green Photo light (near the memory card slots) will blink rapidly.

After the memory card has been inserted properly, the Photo light will blink green for a few seconds, and then remain lit.

Cause: The memory card was inserted backwards or upside down.

If this did not solve the issue, try the next solution.

Solution 2: Insert the memory card fully into the appropriate slot on the product

Solution: Make sure you fully insert the memory card into the appropriate slot on the product.

If the memory card is not inserted properly, the product will not respond and the green Photo light (near the memory card slots) will blink rapidly.

After the memory card has been inserted properly, the Photo light will blink green for a few seconds, and then remain lit.

Cause: The memory card was not fully inserted in the appropriate slot on the product.

If this did not solve the issue, try the next solution.

Solution 3: Remove the additional memory card

Solution: You can insert only one memory card at a time.

If more than one memory card is inserted, the green Photo light (near the memory card slots) will blink rapidly, and an error message will appear on the computer screen. Remove the additional memory card to resolve the problem.

Cause: You had inserted more than one memory card.

If this did not solve the issue, try the next solution.

Solution 4: Reformat the memory card in your digital camera

Solution: Check the computer screen for an error message telling you that the images on the memory card are corrupted.

If the file system on the card is corrupt, reformat the memory card in your digital camera. For more information, see the documentation that came with your digital camera.

△ **CAUTION:** Reformatting the memory card will delete any photos stored on the card. If you have previously transferred the photos from your memory card to a computer, try printing the photos from the computer. Otherwise, you will need to retake any photos you might have lost.

Cause: The memory card file system was corrupted.

The photos on the memory card do not transfer to my computer

Try the following solutions to resolve the issue. Solutions are listed in order, with the most likely solution first. If the first solution does not solve the problem, continue trying the remaining solutions until the issue is resolved.

- [Solution 1: Install the product software](#)
- [Solution 2: Turn on the product](#)
- [Solution 3: Turn on the computer](#)
- [Solution 4: Check the connection from the product to your computer](#)

Solution 1: Install the product software

Solution: Install the product software that came with the product. If it is installed, restart your computer.

To install the product software

1. Insert the product CD-ROM into your computer's CD-ROM drive and then start the Setup program.
2. When prompted, click **Install More Software** to install the product software.
3. Follow the onscreen instructions and the instructions provided in the Start Here guide that came with the product.

Cause: The product software was not installed.

If this did not solve the issue, try the next solution.

Solution 2: Turn on the product

Solution: Turn on the product.

Cause: The product was turned off.

If this did not solve the issue, try the next solution.

Solution 3: Turn on the computer

Solution: Turn on the computer

Cause: The computer was turned off.

If this did not solve the issue, try the next solution.

Solution 4: Check the connection from the product to your computer

Solution: Check the connection from the product to your computer. Verify that the USB cable is securely plugged into the USB port on the back of the product. Make sure the other end of the USB cable is plugged into a USB port on your computer. After the cable is connected properly, turn off the product and then on again. If the product is connected to the computer through a Bluetooth connection, make sure that the connection is active and the product is turned on.

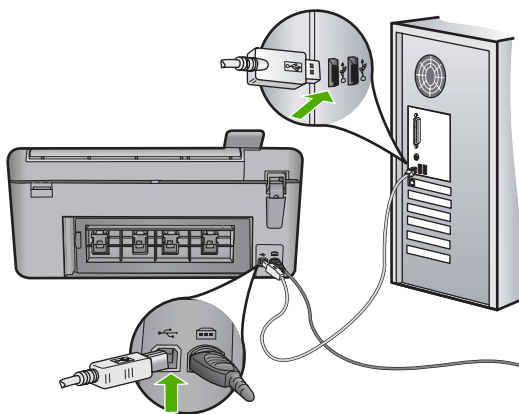

For more information on setting up the product and connecting it to your computer, see the Start Here guide that came with the product.

Cause: The product was not properly connected to the computer.

Photos in a connected digital camera with PictBridge do not print

Try the following solutions to resolve the issue. Solutions are listed in order, with the most likely solution first. If the first solution does not solve the problem, continue trying the remaining solutions until the issue is resolved.

- [Solution 1: Set the camera to PictBridge mode](#)
- [Solution 2: Save the photos in a supported file format](#)
- [Solution 3: Select photos on the camera for printing](#)

Solution 1: Set the camera to PictBridge mode

Solution: If the camera supports PictBridge, make sure the camera is set to PictBridge mode. See the user guide that came with the camera for instructions on how to do this.

Cause: The digital camera was not in PictBridge mode.
If this did not solve the issue, try the next solution.

Solution 2: Save the photos in a supported file format

Solution: Make sure the digital camera is saving photos in a file format that the PictBridge transfer feature supports (Exif/JPEG, JPEG, and DPOF).

Cause: The images were not in a supported format.
If this did not solve the issue, try the next solution.

Solution 3: Select photos on the camera for printing

Solution: Before you connect the digital camera to the front USB port on the product, select some photos on the camera for printing.

 **NOTE:** Some digital cameras do not allow you to select photos until after you have established a PictBridge connection. If this is the case, connect your digital camera to the front USB port, turn on the camera and change it to PictBridge mode, and then use the camera to select the photos you want to print.

Cause: You did not select any photos on the camera for printing.

Scan troubleshooting

Use this section to solve these scan problems:

- [Scan halts](#)
- [Scan fails](#)
- [Scan fails because of insufficient computer memory](#)
- [Scanned image is blank](#)
- [Scanned image is incorrectly cropped](#)
- [Scanned image has incorrect page layout](#)

- [Scanned image shows dotted lines instead of text](#)
- [Text format is incorrect](#)
- [Text is incorrect or missing](#)
- [The scan feature does not work](#)

Scan halts

Solution: Turn off the product and then turn it back on.

If this does not work, try changing the scan to a lower resolution.

Cause: The computer system resources might have been low.

Scan fails

Try the following solutions to resolve the issue. Solutions are listed in order, with the most likely solution first. If the first solution does not solve the problem, continue trying the remaining solutions until the issue is resolved.

- [Solution 1: Turn on your computer](#)
- [Solution 2: Check the connection from the product to your computer](#)
- [Solution 3: Install the HP Photosmart Software](#)
- [Solution 4: Start the HP Photosmart Software](#)

Solution 1: Turn on your computer

Solution: Turn on your computer.

Cause: The computer was not turned on.

If this did not solve the issue, try the next solution.

Solution 2: Check the connection from the product to your computer

Solution: Check the connection from the product to your computer. Verify that the USB cable is securely plugged into the USB port on the back of the product. Make sure the other end of the USB cable is plugged into a USB port on your computer. After the cable is connected properly, turn off the product and then on again. If the product is connected to the computer through a Bluetooth connection, make sure that the connection is active and the product is turned on.

For more information, see the Start Here guide.

Cause: The product was not connected to the computer.

If this did not solve the issue, try the next solution.

Solution 3: Install the HP Photosmart Software

Solution: Insert the HP Photosmart installation CD and install the software.

For more information, see the Start Here guide.

Cause: The HP Photosmart Software might not have been installed.

If this did not solve the issue, try the next solution.

Solution 4: Start the HP Photosmart Software

Solution: Start the software you installed with the product and try scanning again.

Cause: The HP Photosmart Software was installed, but was not running.

Scan fails because of insufficient computer memory

Solution: Close all programs that are not in use. This includes programs that run in the background, such as screen savers and virus checkers. If you turn off your virus checker, remember to turn it back on after you finish your scan.

If this does not work, it might help to restart your computer. Some programs do not release memory when you close them. Restarting your computer will clear the memory.

If this problem occurs frequently, or if you encounter memory problems while using other programs, you might need to add more memory to your computer. See the user guide that came with your computer for more information.

Cause: Too many programs were running on your computer.

Scanned image is blank

Solution: Load your original print side down on the right front corner of the glass.

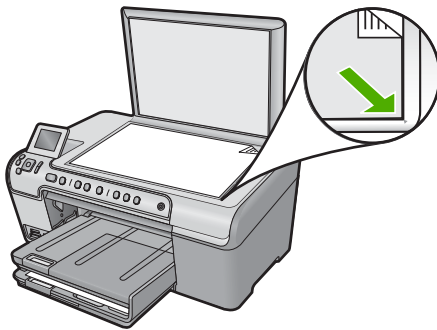

Cause: The original was placed incorrectly on the glass.

Scanned image is incorrectly cropped

Solution: The autcropping feature in the software crops anything that is not part of the main image. Sometimes this might not be what you want. In that case, turn off autcropping in the software and crop the scanned image manually, or not at all.

Cause: The software was set to automatically crop scanned pictures.

Scanned image has incorrect page layout

Solution: Turn off autocropping in the software to retain the page layout.

Cause: Automatic cropping was changing the page layout.

Scanned image shows dotted lines instead of text

Solution: Make a black-and-white copy of the original and then scan the copy.

Cause: If you used the **Text** image type to scan text that you planned to edit, the scanner might not have recognized color text. The **Text** image type scans at 300 x 300 dpi, in black and white.

If you scanned an original that has graphics or artwork surrounding the text, the scanner might not have recognized the text.

Text format is incorrect

Solution: Some applications cannot handle framed text formatting. Framed text is one of the scan document settings in the software. It maintains complex layouts, such as multiple columns from a newsletter, by putting the text in different frames (boxes) in the destination application. In the software, select the correct format so that the scanned text layout and formatting are retained.

Cause: The scan document settings were incorrect.

Text is incorrect or missing

Try the following solutions to resolve the issue. Solutions are listed in order, with the most likely solution first. If the first solution does not solve the problem, continue trying the remaining solutions until the issue is resolved.

- [Solution 1: Adjust the brightness in the software](#)
- [Solution 2: Clean the glass and lid](#)
- [Solution 3: Select the correct OCR language](#)

Solution 1: Adjust the brightness in the software

Solution: Adjust the brightness in the software, and then rescan the original.

Cause: The brightness was not set correctly.

If this did not solve the issue, try the next solution.

Solution 2: Clean the glass and lid

Solution: Turn off the product, unplug the power cord, and use a soft cloth to wipe the glass and the back of the document lid.

For more information, see:

- [“Clean the lid backing” on page 115](#)
- [“Clean the glass” on page 115](#)

Cause: Debris might have been stuck on the glass or on the back of the document lid. This can cause poor-quality scans.

If this did not solve the issue, try the next solution.

Solution 3: Select the correct OCR language

Solution: Select the correct OCR language in the software.

 **NOTE:** If you are using HP Photosmart Essential, the Optical Character Recognition (OCR) software might not be installed on your computer. To install the OCR software, you must re-insert the software disk and select **OCR** under the **Custom** installation options.

Cause: The scan document settings were not set to the correct optical character recognition (OCR) language. The **OCR language** tells the software how to interpret the characters it sees in the original image. If the **OCR language** does not match the language in the original, the scanned text might be incomprehensible.

The scan feature does not work

Try the following solutions to resolve the issue. Solutions are listed in order, with the most likely solution first. If the first solution does not solve the problem, continue trying the remaining solutions until the issue is resolved.

- [Solution 1: Turn on the computer](#)
- [Solution 2: Check the cables](#)
- [Solution 3: Install or reinstall the HP Photosmart Software](#)

Solution 1: Turn on the computer

Solution: Turn on the computer.

Cause: The computer was turned off.

If this did not solve the issue, try the next solution.

Solution 2: Check the cables

Solution: Check the cables that connect the product to your computer.

Cause: The product was not properly connected to the computer through a USB cable.

If this did not solve the issue, try the next solution.

Solution 3: Install or reinstall the HP Photosmart Software

Solution: Install or reinstall the software that came with the product.

Cause: The software that came with the product was not installed or was not running.

Copy troubleshooting

Use this section to solve these copy problems:

- [Nothing happens when I try to copy](#)
- [Parts of the original do not appear or are cut off](#)
- [Fit to Page is not working as expected](#)
- [The image is cropped when I make a borderless copy](#)
- [The printout is blank](#)
- [A borderless copy has white space around the edges](#)

Nothing happens when I try to copy

Try the following solutions to resolve the issue. Solutions are listed in order, with the most likely solution first. If the first solution does not solve the problem, continue trying the remaining solutions until the issue is resolved.

- [Solution 1: Turn on the product](#)
- [Solution 2: Place the original correctly on the glass](#)
- [Solution 3: Wait until the product completes the current operation](#)
- [Solution 4: The product does not support the paper type or envelope](#)
- [Solution 5: Clear the paper jam](#)

Solution 1: Turn on the product

Solution: Look at the On light located on the product. If it is not lit, the product is turned off. Make sure the power cord is firmly connected to the product and plugged into a power outlet. Press the On button to turn on the product.

Cause: The product was turned off.

If this did not solve the issue, try the next solution.

Solution 2: Place the original correctly on the glass

Solution: Load the original print side down on the right front corner of the glass as shown below.

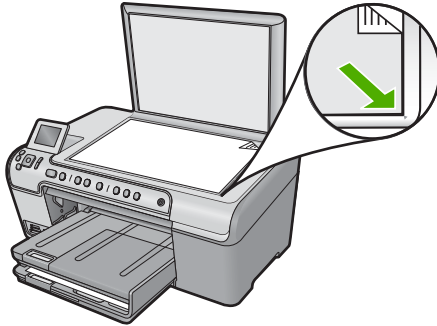

Cause: The original was placed incorrectly on the glass.

If this did not solve the issue, try the next solution.

Solution 3: Wait until the product completes the current operation

Solution: Check the On light. If it is blinking, the product is busy.

Cause: The product was busy copying or printing.

If this did not solve the issue, try the next solution.

Solution 4: The product does not support the paper type or envelope

Solution: Do not use the product to copy onto envelopes or other papers it does not support.

For more information, see:

[“Recommended papers for printing and copying” on page 34](#)

Cause: The product did not recognize the paper type.

If this did not solve the issue, try the next solution.

Solution 5: Clear the paper jam

Solution: Clear the paper jam and remove any torn paper that remains in the product.

For more information, see:

[“Clear paper jams” on page 131](#)

Cause: The product had a paper jam.

Parts of the original do not appear or are cut off

Solution: Load the original print side down on the right front corner of the glass as shown below.

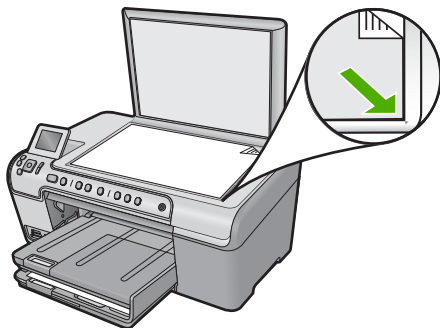

Cause: The original was placed incorrectly on the glass.

Fit to Page is not working as expected

Try the following solutions to resolve the issue. Solutions are listed in order, with the most likely solution first. If the first solution does not solve the problem, continue trying the remaining solutions until the issue is resolved.

- [Solution 1: Scan, enlarge, and then print a copy](#)
- [Solution 2: Place the original correctly on the glass](#)
- [Solution 3: Wipe the glass and the back of the document lid](#)

Solution 1: Scan, enlarge, and then print a copy

Solution: **Fit to Page** can only enlarge the original up to the maximum percentage allowed by your model. For example, 200% might be the maximum enlargement percentage allowed by your model. Enlarging a passport photo by 200% might not enlarge it enough for it to fit a full-size page.

If you want to make a large copy of a small original, scan the original into the computer, resize the image in the HP scanning software, and then print a copy of the enlarged image.

Cause: You were trying to increase the size of an original that was too small.

If this did not solve the issue, try the next solution.

Solution 2: Place the original correctly on the glass

Solution: Load the original print side down on the right front corner of the glass as shown below.

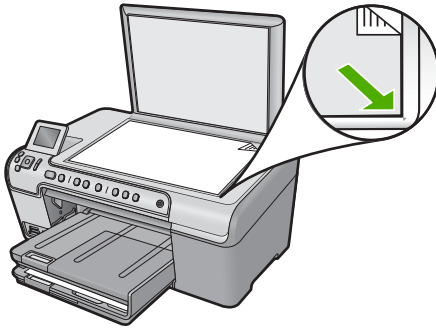

Cause: The original was placed incorrectly on the glass.
If this did not solve the issue, try the next solution.

Solution 3: Wipe the glass and the back of the document lid

Solution: Turn off the product, unplug the power cord, and then use a soft cloth to wipe the glass and the back of the document lid.

For more information, see:

- [“Clean the glass” on page 115](#)
- [“Clean the lid backing” on page 115](#)

Cause: Debris might have been stuck on the glass or on the back of the document lid. The product interprets anything it detects on the glass as part of the image.

The image is cropped when I make a borderless copy

Try the following solutions to resolve the issue. Solutions are listed in order, with the most likely solution first. If the first solution does not solve the problem, continue trying the remaining solutions until the issue is resolved.

- [Solution 1: Use Fit to Page to enlarge the photo](#)
- [Solution 2: Use Fit to Page to reduce the original to fit on the paper](#)

Solution 1: Use Fit to Page to enlarge the photo

Solution: If you want to enlarge a photo to fit a full-size page without cropping the edges, use **Fit to Page**.

For more information, see:

[“Resize an original to fit onto letter or A4 paper” on page 90](#)

Cause: The product cropped some of the image around the margins of the copy to achieve a borderless print without changing the proportions of the original.

If this did not solve the issue, try the next solution.

Solution 2: Use Fit to Page to reduce the original to fit on the paper

Solution: If your original is larger than the paper in the input tray, use the **Fit to Page** feature to reduce your original to fit on the paper in the input tray.

For more information, see:

[“Resize an original to fit onto letter or A4 paper”](#) on page 90

Cause: The original was larger than the paper in the input tray.

The printout is blank

Solution: Load the original print side down on the right front corner of the glass as shown below.

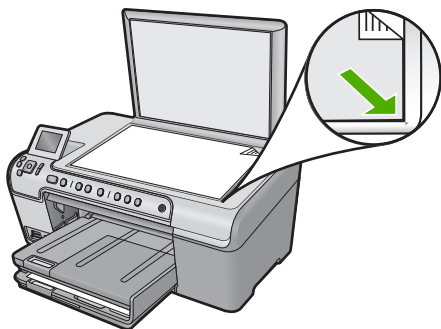

Cause: The original was placed incorrectly on the glass.

A borderless copy has white space around the edges

Try the following solutions to resolve the issue. Solutions are listed in order, with the most likely solution first. If the first solution does not solve the problem, continue trying the remaining solutions until the issue is resolved.

- [Solution 1: Scan, resize, and print the image](#)
- [Solution 2: Use photo paper to make borderless copies](#)

Solution 1: Scan, resize, and print the image

Solution: When you make a borderless copy of a very small original, the product enlarges the original up to a maximum percentage. This might leave white space around the edges. (The maximum percentage varies by model.)

Depending on the size of the borderless copy you are trying to make, the minimum size of the original varies. For example, you cannot enlarge a passport photo to create a letter-size borderless copy.

If you want to make a borderless copy of a very small original, scan the original into the computer, resize the image, and then print a borderless copy of the enlarged image.

Cause: You were trying to make a borderless copy of a very small original. If this did not solve the issue, try the next solution.

Solution 2: Use photo paper to make borderless copies

Solution: Use photo paper to make borderless copies.

For more information, see:

- [“Recommended papers for printing and copying”](#) on page 34
- [“Load paper”](#) on page 37

Cause: You were trying to make a borderless copy without using photo paper.

CD/DVD print troubleshooting

Use this section to solve any problems you might encounter while printing on CD/DVD surfaces with the HP All-in-One.

This section contains the following topics:

- [The product does not detect the CD/DVD holder](#)
- [The product does not detect a CD/DVD on the holder](#)
- [The product stalled while printing a CD/DVD](#)
- [The image on my printed disc is cropped and there is ink on the CD/DVD holder](#)
- [The product is printing on a non-printable area of my disc](#)
- [The design is not centered on my disc](#)
- [The ink on the CD/DVD is not drying](#)
- [The product reports a CD/DVD size mismatch error](#)
- [The CD/DVD holder is stuck in the storage area](#)

The product does not detect the CD/DVD holder

Try the following solutions to resolve the issue. Solutions are listed in order, with the most likely solution first. If the first solution does not solve the problem, continue trying the remaining solutions until the issue is resolved.

- [Solution 1: Push the CD/DVD holder into the CD/DVD tray](#)
- [Solution 2: Remove the CD/DVD holder from the storage area](#)
- [Solution 3: Place the CD/DVD on the CD/DVD holder](#)
- [Solution 4: Load the next disc on the CD/DVD holder](#)

Solution 1: Push the CD/DVD holder into the CD/DVD tray

Solution: Push the CD/DVD holder forward into the CD/DVD tray until the lines on the holder line up to the white lines on the tray. The end of the holder marked with arrows goes into the CD/DVD tray first.

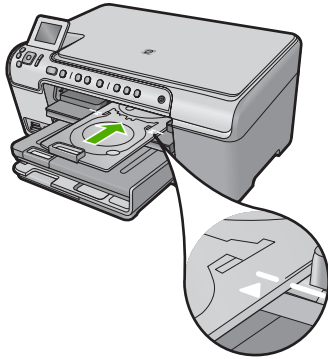

Cause: You did not push the CD/DVD holder far enough into the CD/DVD tray. If this did not solve the issue, try the next solution.

Solution 2: Remove the CD/DVD holder from the storage area

Solution: Remove the CD/DVD holder from the storage area below the main input tray. Make sure CD/DVD tray has been lowered and the printable disc is loaded onto the CD/DVD holder with the printable side up. Push the holder forward into the CD/DVD tray located below the control panel until the white lines on the holder line up to the white lines on the tray. The end of the holder marked with arrows goes into the CD/DVD tray first.

Cause: You inserted the CD/DVD holder back into the storage area. If this did not solve the issue, try the next solution.

Solution 3: Place the CD/DVD on the CD/DVD holder

Solution: Remove the CD/DVD holder from the storage area below the main input tray. Make sure CD/DVD tray has been lowered and the printable disc is loaded onto the CD/DVD holder with the printable side up. Push the holder forward into the CD/DVD tray located below the control panel until the white lines on the holder line up to the white lines on the tray. The end of the holder marked with arrows goes into the CD/DVD tray first.

Cause: You inserted the disc directly into the CD/DVD tray without placing it on the CD/DVD holder.

If this did not solve the issue, try the next solution.

Solution 4: Load the next disc on the CD/DVD holder

Solution: Remove the CD/DVD holder from the CD/DVD tray. Remove the printed CD/DVD from the holder. Load the next disc onto the CD/DVD holder with the printable side up and reinsert the holder into the CD/DVD tray until the lines on the holder line up to the white lines on the tray. When the product detects the holder, the prompt disappears.

Cause: The product prompted you to insert the next disc when printing multiple CD/DVDs in a print job.

The product does not detect a CD/DVD on the holder

Try the following solutions to resolve the issue. Solutions are listed in order, with the most likely solution first. If the first solution does not solve the problem, continue trying the remaining solutions until the issue is resolved.

- [Solution 1: Load a CD/DVD on the CD/DVD holder](#)
- [Solution 2: Load a CD/DVD with the printable side up](#)

Solution 1: Load a CD/DVD on the CD/DVD holder

Solution: Remove the CD/DVD holder from the CD/DVD tray. Load a printable disc onto the CD/DVD holder with the printable side up and reinsert the holder into the CD/DVD tray until the lines on the holder line up to the white lines on the tray.

Cause: You inserted the CD/DVD holder into the CD/DVD tray without loading a CD/DVD onto the holder.

If this did not solve the issue, try the next solution.

Solution 2: Load a CD/DVD with the printable side up

Solution: Remove the CD/DVD holder from the CD/DVD tray. Load a printable disc onto the CD/DVD holder with the printable side up and reinsert the holder into the CD/DVD tray until the lines on the holder line up to the white lines on the tray.

Cause: You loaded the CD/DVD upside down on the holder.

The product stalled while printing a CD/DVD

Solution: Ensure that there is at least 7.5 cm (3 inches) of space behind the product. Also, make sure that the slot on the back of the product is not blocked.

Cause: The product pulled the CD/DVD holder while printing on the CD/DVD. The holder can protrude about 7.5 cm (3 inches) from the back of the product. If there is not sufficient space behind the product, the holder stops and printing stalls.

The image on my printed disc is cropped and there is ink on the CD/DVD holder

Solution: If you are loading a regular-size (120 mm) CD/DVD onto the CD/DVD holder to be printed, **do not** flip the blue ring over the disc. The blue ring should only be used if you are printing on a small-size (80 mm) CD/DVD.

Before trying again, clean the CD/DVD holder to remove ink from the holder. This avoids ink contamination within the product, as well as protects your discs, hands, and clothing from stains later.

After the CD/DVD holder is clean and dry, load a new printable disc onto the holder with the printable side up. Leave the blue ring in its original location on the opposite side of the holder from your disc, as shown below. Reinsert the holder into the CD/DVD tray until the lines on the holder line up to the white lines on the tray and try your print again.

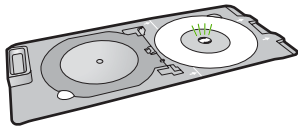

Cause: You loaded the CD/DVD onto the CD/DVD holder incorrectly.

The product is printing on a non-printable area of my disc

Try the following solutions to resolve the issue. Solutions are listed in order, with the most likely solution first. If the first solution does not solve the problem, continue trying the remaining solutions until the issue is resolved.

- [Solution 1: Change the software settings](#)
- [Solution 2: Load a new CD/DVD with the printable side up](#)

Solution 1: Change the software settings

Solution: Make sure the design you are printing is appropriate for the size of the media loaded in the CD/DVD holder, including the diameter of the inner and outer rings. Change the software settings accordingly to center and size your design for the disc you are using. Refer to the documentation or the online help of the software you are using for additional information.

Cause: Your design was not the correct size for the CD/DVD you loaded.

If this did not solve the issue, try the next solution.

Solution 2: Load a new CD/DVD with the printable side up

Solution: If you have already burned your content onto the CD/DVD, you might need to burn your contents again onto a new disc. Load the new disc onto the CD/DVD holder with the printable side up. Reinsert the holder into the CD/DVD tray until the lines on the holder line up to the white lines on the tray and try your print again.

Cause: You loaded the CD/DVD upside down on the holder.

The design is not centered on my disc

Solution: Change the software settings to center and size your design for the disc you are using. Refer to the documentation or the online help of the software you are using for additional information.

Cause: Your design settings were not correct.

The ink on the CD/DVD is not drying

Try the following solutions to resolve the issue. Solutions are listed in order, with the most likely solution first. If the first solution does not solve the problem, continue trying the remaining solutions until the issue is resolved.

- [Solution 1: Use inkjet printable discs](#)
- [Solution 2: Load a new CD/DVD with the printable side up](#)

Solution 1: Use inkjet printable discs

Solution: Make sure that the CD/DVD you use is compatible for inkjet printing. Inkjet printable discs normally have a white printing surface. (Some discs also have a silver printing surface.)

Cause: The surface of the disc was not compatible for printing.

If this did not solve the issue, try the next solution.

Solution 2: Load a new CD/DVD with the printable side up

Solution: If you have already burned your content onto the CD/DVD, you might need to burn your contents again onto a new disc. Load the new disc onto the CD/DVD holder with the printable side up. Reinsert the holder into the CD/DVD tray until the lines on the holder line up to the white lines on the tray and try your print again.

Cause: You loaded the CD/DVD upside down on the holder.

The product reports a CD/DVD size mismatch error

Solution: Cancel the print job and replace the CD/DVD currently loaded on the CD/DVD holder with a CD/DVD that is the same size as specified in the print job, or change the print settings in the software.

Cause: The size of the CD/DVD currently loaded on the CD/DVD holder did not match the size you specified when you started the print job from the computer.

The CD/DVD holder is stuck in the storage area

Solution: Pull the CD/DVD holder out as far as possible, until you feel resistance. Then, insert a flat blunt object (such as a butter knife or screwdriver) into the left corner of the storage slot and push down on the blue ring. With the blue ring pressed down, you should be able to pull the CD/DVD holder out of the storage slot.

Cause: You inserted the CD/DVD holder back into the storage area.

Errors

If the product has an error, the lights on the product might flash, or an error message might appear on your computer screen.

This section contains the following topics:

- [Product messages](#)
- [File messages](#)
- [General user messages](#)
- [Paper messages](#)
- [Power and connection messages](#)
- [Print cartridge messages](#)

Product messages

The following is a list of product-related error messages:

- [Carriage jam](#)
- [Product stall error](#)
- [Mechanism error](#)
- [Carriage blocked](#)
- [Firmware revision mismatch](#)
- [Memory is full](#)
- [Photo tray problem](#)
- [Photo tray cannot engage](#)
- [Photo tray cannot disengage](#)
- [CD/DVD tray open](#)
- [CD/DVD tray misaligned](#)
- [Insert CD/DVD holder](#)
- [Open CD/DVD tray](#)
- [CD/DVD holder not found](#)
- [CD/DVD not found](#)
- [Scan errors](#)
- [Unable to print](#)
- [Product might not be correctly installed](#)
- [Product was not found](#)
- [Product could not find available scan destinations](#)
- [Required software component was not found or was incorrectly installed](#)
- [Error occurred while communicating with the product](#)
- [Missing HP Photosmart Software](#)

Carriage jam

Try the following solutions to resolve the issue. Solutions are listed in order, with the most likely solution first. If the first solution does not solve the problem, continue trying the remaining solutions until the issue is resolved.

- [Solution 1: Clear the paper jam from the rear door](#)
- [Solution 2: Clear the paper jam from the front](#)
- [Solution 3: Make sure the print carriage can move freely](#)
- [Solution 4: Verify that the product is properly connected to a power source](#)
- [Solution 5: Print a self-test report](#)
- [Solution 6: Reset the product](#)
- [Solution 7: Contact HP support for service](#)

Solution 1: Clear the paper jam from the rear door

Solution: Clear the paper jam from the rear door.

For more information, see:

[“Clear paper jams” on page 131](#)

Cause: The product had a paper jam.

If this did not solve the issue, try the next solution.

Solution 2: Clear the paper jam from the front

Solution: Turn off the product and open the print cartridge door to access the print carriage area. Gently remove any paper that is stuck between the rollers, and then turn on the product again.

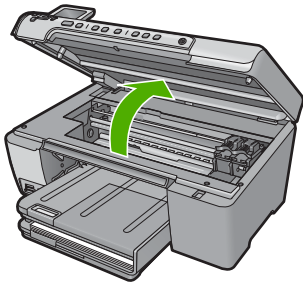

If this did not solve the issue, try the next solution.

Cause: Paper was stuck in the front rollers.

If this did not solve the issue, try the next solution.

Solution 3: Make sure the print carriage can move freely

Solution: Unplug the power cable if it is not already unplugged. Check to see if the print cartridge carriage will move freely from one side of the printer to the other. Do not try to force it to move if it is hung up on something.

△ **CAUTION:** Be careful not to force the print cartridge carriage. If the carriage is stuck, forcing it to move will damage the printer.

For more information, see:

[“Carriage stall” on page 245](#)

Cause: The print carriage had stalled.

If this did not solve the issue, try the next solution.

Solution 4: Verify that the product is properly connected to a power source

Solution: Verify that the product is properly connected to a suitable power source.

To verify the product is connected to a suitable power source

1. Make sure that you are using the power cord provided with the product.
2. If the product is connected to a computer, make sure the computer has a grounded (three-prong) power plug.
3. Make sure the power cord is firmly connected to both the product and the power adaptor.
4. Plug the power cord directly into a power outlet.

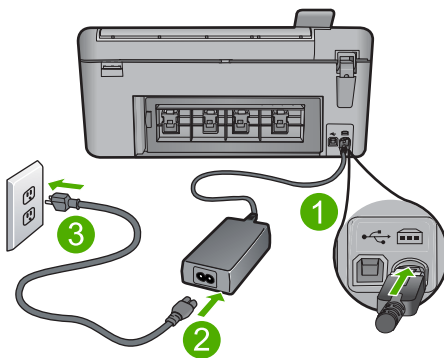

1	Power connection
2	Power cord and adaptor
3	Power outlet

5. Try to print from your computer.
If the product prints when plugged directly into a power outlet while disconnected from any power strips or surge suppressors, the power strip or surge suppressor might not be allowing sufficient voltage to reach the product.
6. If the product cannot print and the print carriage is still stalled, contact HP support for service.
Go to: www.hp.com/support.
If prompted, choose your country/region, and then click **Contact HP** for information on calling for technical support.

Cause: There might not be sufficient voltage for the product.

If this did not solve the issue, try the next solution.

Solution 5: Print a self-test report

Solution: Print a self-test report to see if the product can print.

To print a self-test report

1. Load letter or A4 unused plain white paper into the input tray.
2. Press and hold the Cancel button and then press the **Start Copy Color** button.
The product prints a self-test report, which might indicate the source of the printing problem. A sample of the ink test area of the report is shown below.



3. Make sure the test patterns show a complete grid and the thick color lines are complete.
 - If more than a few lines in a pattern are broken, this might indicate a problem with the nozzles. You might need to clean the print cartridges.
 - If the black line is missing, faded, streaked, or shows lines, this might indicate a problem with the black or photo print cartridge in the right slot.
 - If any of the color lines are missing, faded, streaked, or show lines, this might indicate a problem with the tri-color print cartridge in the left slot.

If the product can print a self-test report and can print from the computer (if applicable), then there is no need to follow the remaining solutions, as the error message might be false.

Cause: The error was false.

If this did not solve the issue, try the next solution.

Solution 6: Reset the product

Solution: Turn off the product, and then unplug the power cord. Plug the power cord back in, and then press the On button to turn on the product.

To reset the product

1. Remove all paper loaded in the input tray.
2. Make sure that the product is turned on and remove the USB cable from the back of the product.
3. Open the print cartridge door.

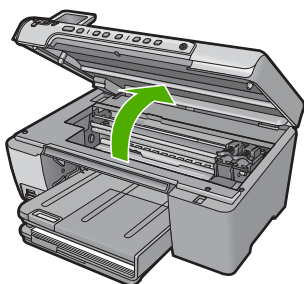

The print carriage should move to the far right side of the product.

4. Remove the print cartridges and keep them aside carefully.
5. Close the print cartridge door.
6. Disconnect the power cord from the product and wait for 60 seconds.
7. Reconnect the power cord to the product.
8. Turn on the product by pressing the On button.
9. Open the print cartridge door.

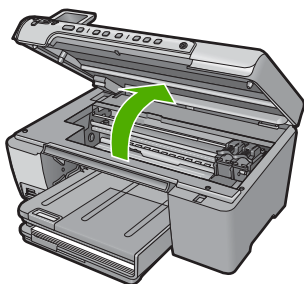

The print carriage should move to the far right side of the product.

10. Reinsert the print cartridges in the appropriate slots.

11. Close the print cartridge door.
12. Load paper in the input tray.
13. If prompted, print a cartridge calibration page, and then scan it.

Cause: The product experienced an error and had to be reset.

If this did not solve the issue, try the next solution.

Solution 7: Contact HP support for service

Solution: If you have completed all of the steps provided in the previous solutions and are still having a problem, contact HP support for service.

Go to: www.hp.com/support.

If prompted, choose your country/region, and then click **Contact HP** for technical support.

Cause: You might need assistance to enable the product or software to function properly.

Product stall error

Try the following solutions to resolve the issue. Solutions are listed in order, with the most likely solution first. If the first solution does not solve the problem, continue trying the remaining solutions until the issue is resolved.

- [Solution 1: Reset the product](#)
- [Solution 2: Contact HP support](#)

Solution 1: Reset the product

Solution: Turn off the product and reset it by disconnecting the power cord. Wait 60 seconds, and then plug in the power cord. Turn on the product.

Cause: You needed to reset the product.

If this did not solve the issue, try the next solution.

Solution 2: Contact HP support

Solution: Contact HP support for service.

Go to: www.hp.com/support.

If prompted, choose your country/region, and then click **Contact HP** for information on calling for technical support.

Cause: There was a problem with the product.

Mechanism error

Try the following solutions to resolve the issue. Solutions are listed in order, with the most likely solution first. If the first solution does not solve the problem, continue trying the remaining solutions until the issue is resolved.

- [Solution 1: Clear the paper jam](#)
- [Solution 2: Remove objects that are blocking the print carriage](#)

Solution 1: Clear the paper jam

Solution: Clear the paper jam and remove any torn paper that remains in the product.

For more information, see:

[“Clear paper jams” on page 131](#)

Cause: The product had a paper jam.

If this did not solve the issue, try the next solution.

Solution 2: Remove objects that are blocking the print carriage

Solution: Lower the ink cartridge access door to access the print carriage. Remove any objects that are blocking the print carriage, including any packing materials. Turn off the product and then turn it on again.

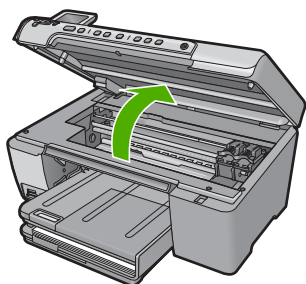

Cause: The print carriage was blocked.

Carriage blocked

Solution: Turn off the product and open the print cartridge door to access the print carriage area. Remove any objects that are blocking the print carriage (including any packing materials), and then turn on the product again.

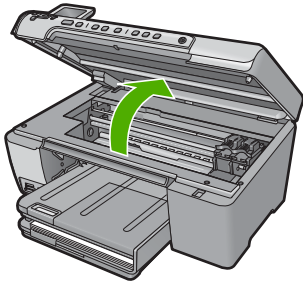

Follow the prompts on the display to continue.

Cause: The print carriage was blocked.

Firmware revision mismatch

Solution: Contact HP support for service.

Go to: www.hp.com/support.

If prompted, choose your country/region, and then click **Contact HP** for information on calling for technical support.

Cause: The revision number of the product firmware did not match the revision number of the software.

Memory is full

Solution: Try making fewer copies at a time.

Cause: The document you were copying exceeded the memory of the product.

Photo tray problem

Try the following solutions to resolve the issue. Solutions are listed in order, with the most likely solution first. If the first solution does not solve the problem, continue trying the remaining solutions until the issue is resolved.

- [Solution 1: Load more paper in the photo tray](#)
- [Solution 2: Make sure paper is loaded correctly in the photo tray](#)
- [Solution 3: Remove excess paper from the photo tray](#)
- [Solution 4: Make sure the sheets of paper are not stuck together](#)
- [Solution 5: Make sure the photo paper is not curled](#)
- [Solution 6: Load one sheet of paper at a time](#)

Solution 1: Load more paper in the photo tray

Solution: If the photo tray is empty or there are only a few sheets remaining, load more paper in the photo tray. If there is paper in the photo tray, remove the paper, tap the stack of paper against a flat surface, and reload the paper into the photo tray. Follow the prompts on the display or the computer screen to continue your print job.

Do not overload the photo tray; make sure the stack of photo paper fits within the photo tray and is no higher than the top of the paper-width guide.

Cause: There was not enough paper in the photo tray.

If this did not solve the issue, try the next solution.

Solution 2: Make sure paper is loaded correctly in the photo tray

Solution: Make sure you have paper loaded correctly in the photo tray.

For more information, see:

[“Load paper” on page 37](#)

Cause: The paper was not feeding properly because it was loaded incorrectly.

If this did not solve the issue, try the next solution.

Solution 3: Remove excess paper from the photo tray

Solution: Do not overload the photo tray; make sure the stack of photo paper fits within the photo tray and is no higher than the top of the paper-width guide.

Cause: There was too much paper loaded in the photo tray.

If this did not solve the issue, try the next solution.

Solution 4: Make sure the sheets of paper are not stuck together

Solution: Remove the paper from the photo tray and shuffle the paper so it does not stick together. Reload the paper into the photo tray and try printing again.

Cause: Two or more pieces of paper were stuck together.

If this did not solve the issue, try the next solution.

Solution 5: Make sure the photo paper is not curled

Solution: If the photo paper is curled, place the paper in a plastic bag and gently bend it the opposite direction of the curl until the paper lies flat. If the problem persists, use photo paper that is not curled.

Cause: The photo paper was curled.

If this did not solve the issue, try the next solution.

Solution 6: Load one sheet of paper at a time

Solution: Try loading just one sheet of photo paper in the photo tray at a time.

Cause: Paper might not feed properly if you are using the product in an extremely high- or low-humidity environment.

Photo tray cannot engage

Solution: Remove the output tray, and then replace it. Push the output tray in as far as it will go. Make sure the output is lowered all the way and lays flat.

Cause: The output tray was not inserted all the way.

Photo tray cannot disengage

Solution: Push the output tray all the way down.

Cause: The output tray was not lowered all the way.

CD/DVD tray open

Solution: Close the CD/DVD tray.

Cause: The CD/DVD tray was open when a print job was started from the computer.

CD/DVD tray misaligned

Solution: Remove the CD/DVD holder from the CD/DVD tray and then reinsert the holder. Make sure you push the CD/DVD holder into the tray evenly. Push the holder forward until the lines on the CD/DVD holder line up to the white lines on the CD/DVD tray.

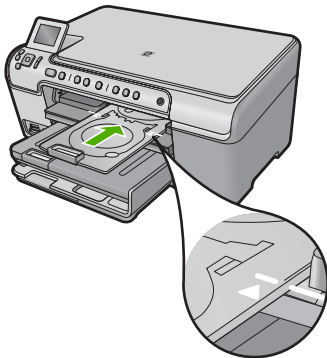

Cause: The CD/DVD holder was loaded incorrectly in the CD/DVD tray.

Insert CD/DVD holder

Try the following solutions to resolve the issue. Solutions are listed in order, with the most likely solution first. If the first solution does not solve the problem, continue trying the remaining solutions until the issue is resolved.

- [Solution 1: Load a CD/DVD on the CD/DVD holder](#)
- [Solution 2: Load the next CD/DVD on the CD/DVD holder](#)

Solution 1: Load a CD/DVD on the CD/DVD holder

Solution: Load the printable disc onto the CD/DVD holder with the printable side up. Lower the CD/DVD tray. Push the holder forward until the lines on the CD/DVD holder line up to the white lines on the CD/DVD tray. The end marked with arrows goes into the CD/DVD tray first.

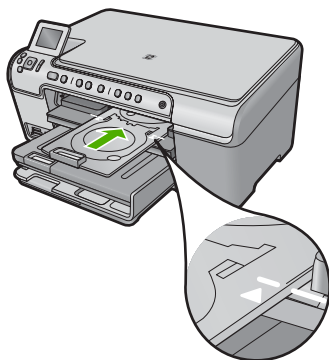

For more information, see:

[“Load a CD/DVD” on page 45](#)

Cause: The product prompted you to insert the CD/DVD holder for a single CD/DVD print job.

If this did not solve the issue, try the next solution.

Solution 2: Load the next CD/DVD on the CD/DVD holder

Solution: Remove the CD/DVD holder from the CD/DVD tray. Remove the printed CD/DVD from the holder. Load the next disc onto the CD/DVD holder with the printable side up and push the CD/DVD holder back into the CD/DVD tray until the lines on the holder line up to the white lines on the CD/DVD tray.

Cause: The product prompted you to insert the next disc when printing multiple CD/DVDs in a print job.

Open CD/DVD tray

Solution: Lower the CD/DVD tray. To continue, press **OK**.

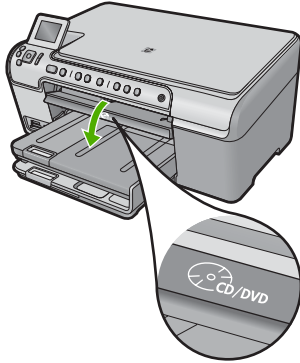

Cause: The CD/DVD tray was closed and a CD/DVD print job was started from the computer.

CD/DVD holder not found

Solution: Load a printable disc onto the CD/DVD holder with the printable side up. Lower the CD/DVD tray. Push the holder forward until the lines on the CD/DVD holder line up to the white lines on the CD/DVD tray. The end marked with arrows goes into the CD/DVD tray first. To continue, press **OK**.

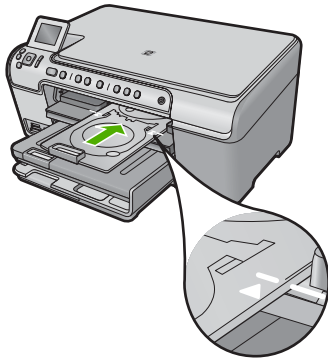

Cause: The CD/DVD holder was not inserted or it was not pushed in far enough.

CD/DVD not found

Solution: Remove the CD/DVD holder from the CD/DVD tray. Load a printable disc onto the CD/DVD holder with the printable side up, and then push the CD/DVD holder back into the CD/DVD tray until the lines on the holder line up to the white lines on the CD/DVD tray. To continue, press **OK**.

Cause: A printable CD/DVD was not found in the holder.

Scan errors

Review this section if you receive an error such as one of the following:

- An error occurred communicating with the scanning device.
- The scanning device could not be initialized.
- The scanning device could not be found.
- An internal error has occurred.
- The computer cannot communicate with the scanning device.



NOTE: Before starting to troubleshoot, make a copy to verify that the hardware is functioning correctly. If you cannot make a copy, see [“Troubleshooting” on page 119](#) for more troubleshooting information.

Try each of the following solutions separately. After completing the steps for each solution, try to scan again. If the product still does not work, then go to the next solution.

- [Solution 1: Verify if the software is installed correctly](#)
- [Solution 2: Refresh the Windows Device Manager](#)
- [Solution 3: Verify if the Digital Imaging Monitor is running](#)
- [Solution 4: Check the status of the product in the HP Solution Center](#)
- [Solution 5: Check the power supply](#)
- [Solution 6: Check the USB connection between the product and the computer](#)
- [Solution 7: Try scanning with Windows Image Acquisition \(WIA\)](#)
- [Solution 8: Disable the Lexbces service](#)
- [Solution 9: Run the Scan Diagnostic Utility](#)
- [Solution 10: Download and install the unexpected internal error and communications failure patch](#)
- [Solution 11: Check the USB chipset and controller](#)
- [Solution 12: Uninstall and then reinstall the software](#)

Solution 1: Verify if the software is installed correctly

Solution: Verify that the software was installed correctly. Open the HP Solution Center and verify that all the icons are present.

If the appropriate buttons for your product (such as **Make Copies**) do not appear, your installation might not be complete, and you might need to uninstall and then reinstall the software. Do not simply delete the application files from your hard drive. Make sure to remove them properly using the uninstall utility provided with the software.

To uninstall and reinstall the software

1. On the Windows taskbar, click **Start, Settings, Control Panel** (or just **Control Panel**).
2. Double-click **Add/Remove Programs** (or click **Uninstall a program**).

3. Select **HP Photosmart All-In-One Driver Software**, and then click **Change/Remove**.
Follow the onscreen instructions.
4. Disconnect the product from your computer.
5. Restart your computer.



NOTE: It is important that you disconnect the product before restarting your computer. Do not connect the product to your computer until after you have reinstalled the software.

6. Insert the product CD-ROM into your computer's CD-ROM drive and then start the Setup program.



NOTE: If the Setup program does not appear, locate the setup.exe file on the CD-ROM drive and double-click it.

NOTE: If you no longer have the installation CD, you can download the software from www.hp.com/support.

7. Follow the onscreen instructions and the instructions provided in the Start Here guide that came with the product.

After you have reinstalled the software, try to scan again.

Cause: The software installation was not complete.

If this did not solve the issue, try the next solution.

Solution 2: Refresh the Windows Device Manager

Solution: Refresh the Windows Device Manager.

To refresh the Windows Device Manager

1. On the Windows taskbar, click **Start**, right-click **My Computer**, and then click **Properties**.
2. Click the **Hardware** tab, and then click **Device Manager**.
3. Double-click **Universal Serial Bus Controllers**.
4. Click **USB Composite Device**, click **Action**, and then click **Uninstall**.
If a screen appears to confirm the deletion, confirm the deletion.
5. Disconnect the USB cable from the product.
6. Wait a few seconds, and then reconnect the cable.
This should restart the Windows device detection (Plug and Play). A **New Hardware found screen** might appear.
7. Click **Next** through all of the screens that appear in the Wizard to install the USB Composite Device.
8. Click **Finish** to complete the installation.
9. Try to scan again.
10. If these steps do not resolve the problem, try using a different USB cable to connect the product to the computer.

Cause: Communication problems between the product and the USB controller caused this error to occur. This might be caused by an incomplete installation, a USB cable longer than 3 meters (9.8 feet) in length, or a defective USB cable.

If this did not solve the issue, try the next solution.

Solution 3: Verify if the Digital Imaging Monitor is running

Solution: Verify that the **Digital Imaging Monitor** is running.

To check that the Digital Imaging Monitor is running

1. Look for the **Digital Imaging Monitor** icon in the system tray at the lower right side of the screen, near the time.
2. If the **Digital Imaging Monitor** icon is not present, restart the computer.
3. After the computer restarts, try to scan again.

Cause: The **Digital Imaging Monitor** was not running.

If this did not solve the issue, try the next solution.

Solution 4: Check the status of the product in the HP Solution Center

Solution: Check the status of the product in the HP Solution Center.

To check the status of the product

1. On the Windows taskbar, click **Start, Programs** or **All Programs, HP, HP Solution Center**.
2. Verify that the product is listed in the **Select Device** area or that the appropriate tab is selected.
3. Click **Status**.
If the product is working properly, a message appears indicating your product is ready.
4. If you receive a **Disconnected** error message, then check whether there is another instance or another tab for the product with a copy number included, such as HP Photosmart C5500 All-in-One series 2.
5. Select the second instance of the product and repeat steps 2 through 4.
6. Try to scan again.

Cause: There might have been two instances of the product connected to the HP Solution Center.

If this did not solve the issue, try the next solution.

Solution 5: Check the power supply

Solution: Check the power supply.

To check the power supply

1. Make sure the power cord is firmly connected to both the product and the power adapter. Plug the power cord into a power outlet, surge protector, or power strip.

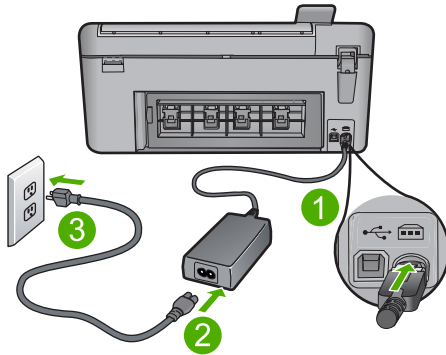

1	Power connection
2	Power cord and adapter
3	Power outlet

2. Make sure the product is turned on.
3. If the product is not receiving electrical power, connect it to another power outlet.
4. Turn off the product and reset it by disconnecting the power cord.
5. Wait 5 seconds, and plug in the power cord.
6. Turn on the product.
7. Try to scan again.

Cause: The product was not properly connected to a power supply or needed to be reset.

If this did not solve the issue, try the next solution.

Solution 6: Check the USB connection between the product and the computer

Solution: Check the USB connection between the product and the computer.

To check the USB connection

1. Verify that the USB cable is securely plugged into the USB port on the back of the product.
2. Make sure the other end of the USB cable is plugged into a USB port on your computer.

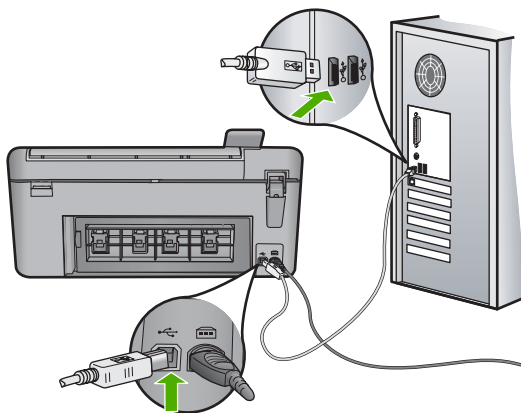

3. Try to scan again.
If the scan fails, continue to the next step.
4. Do one of the following, depending upon how the product is connected to the computer:
 - If the USB cable is connected to a USB hub, try unplugging and replugging the USB cable into the hub. If that does not work, try turning off the hub and then turning it on again. Finally, try disconnecting the cable from the hub and connecting it directly to the computer.
 - If the USB cable is connected to a docking station for a laptop, disconnect the cable from the docking station and connect it directly to the computer.
 - If the USB cable is directly connected to the computer, try plugging it into another USB port on the computer.
5. If there are other USB devices connected to the computer, disconnect the other devices, except for the keyboard and the mouse.
6. Check the USB cable to make sure it is functioning properly.

 **NOTE:** If you are using an older cable, it might not be working properly. Try connecting it to another product to see if the USB cable works. If you experience problems, the USB cable might need to be replaced. Also verify that the cable does not exceed 3 meters (9.8 feet) in length.

7. If another USB cable is available, try using that one instead.

8. Restart the computer.
 9. After the computer restarts, try to scan again.
- Cause:** The product was not properly connected to the computer.
If this did not solve the issue, try the next solution.
-

Solution 7: Try scanning with Windows Image Acquisition (WIA)

Solution: Try scanning with Windows Image Acquisition (WIA) instead of the HP Solution Center.

To scan using WIA

1. Make sure the product is turned on.
2. Verify that the USB cable is securely plugged into the USB port on the back of the product.
The USB icon on the cable faces up when the cable is properly connected.
3. Make sure the other end of the USB cable is plugged into a USB port on your computer.

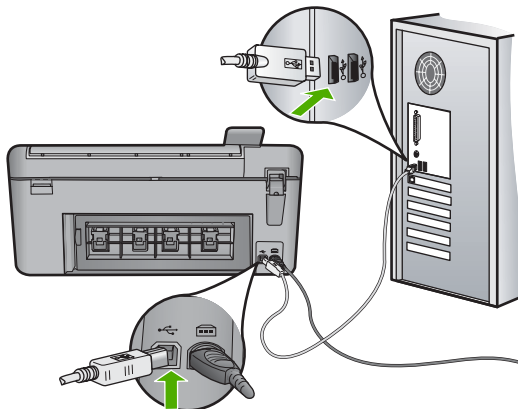

4. On the Windows taskbar, click **Start**, click **Programs** or **All Programs**, and then click **Accessories**.
5. Click **Imaging**.
6. From the Imaging application, click **File** and then click **Select Device**.
7. Select the product from the TWAIN source list.
8. Click **File**, and then click **Scan New**.
Imaging for Windows will scan from the product using TWAIN software instead of the HP Solution Center.

Cause: If you could scan using WIA, this is an indication that there was a problem with the HP Solution Center. You can continue to use WIA to scan, or try the next solution.

If this did not solve the issue, try the next solution.

Solution 8: Disable the Lexbces service

Solution: Check if the **Lexbces** service is started, and disable it.

If a Lexmark or Dell all-in-one device is connected with a USB cable to a computer where product is installed, the HP software might not scan because the **Lexbces** service is running.

 **NOTE:** This solution only applies if you have a Lexmark or Dell all-in-one.

To check for and disable the service

1. Log into Windows as an Administrator.
2. Press the **Ctrl + Alt + Delete** to open the **Task Manager**.
3. Click the **Processes** tab.
4. If the Lexbceserver service is listed in the **Image Name** list, disable it.

To disable the service

- a. On the Windows taskbar, click **Start**, right-click **My Computer**, and then click **Manage**.
The **Computer Management** appears.
- b. Double-click **Services and Applications**, and then double-click **Services**.
- c. In the right pane, right-click **Lexbceserver**, and then click **Properties**.
- d. On the **General** tab, in the **Service status** area, click **Stop**.
- e. From the **Startup type** drop-down menu, select **Disabled**, and then click **OK**.
- f. Click **OK** to close the dialog box.
5. Backup the Registry.

△ **CAUTION:** Incorrectly editing the registry might severely damage your system. Before making changes to the registry, back up valuable data on the computer.

To back up the Registry

- a. On the Windows taskbar, click **Start**.
- b. Depending on your operating system, do one of the following:
 - In Windows Vista: In **Start Search**, type `regedit`, and then press **Enter**.
When the User Account Control dialog box appears, click **Continue**.
 - In Windows XP: Click **Run**. When the **Run** dialog box appears, type `regedit`, and then press **Enter**.
The **Registry Editor** appears.
- c. In the **Registry Editor**, select **My Computer**.
- d. With **My Computer** highlighted, click **File**, and then click **Export**.
- e. Browse to a storage location that is easy for you to remember; for example: **My Documents** or **Desktop**.
- f. In the **Export Range** area, select **All**.

- g. Enter a filename for the backed up Registry.
HP suggests naming the file with the current date; for example: Registry Backup 04_01_07.
 - h. Click **Save** to save the Registry.
6. Edit the registry.

To edit the Registry

- a. Select the **HKEY_LOCAL_MACHINE\System\CurrentControlSet\Services\Spooler** Registry key.
Details of the Registry key appears on the pane to the right.
 - b. Check the **DependOnService** data string (in the pane on the right) to see if **lexbces** is listed in the **Data** column.
 - c. If the **Data** column contains **lexbces**, right-click **DependOnService** and select **Modify**.
Do one of the following:
 - If you see only **lexbces**, but not **RPCSS**, delete **lexbces** and enter **RPCSS**.
 - If you see both **lexbces** and **RPCSS**, delete only **lexbces** and keep **RPCSS**.
 - d. Click **OK**.
7. Restart the computer, and then try to scan again.
If you can scan successfully, then proceed with the next step to restart the **Lexbcservice** service.



NOTE: Restarting the service enables the normal functionality of the Lexmark or Dell devices without affecting HP software.

8. Restart the **Lexbcservice** service.

To restart the service

- a. On the Windows taskbar, click **Start**, right-click **My Computer**, and then click **Manage**.
The **Computer Management** screen appears.
- b. Double-click **Services and Applications**, and then double-click **Services**.
- c. In the right pane, right-click **Lexbcservice**, and then click **Properties**.
- d. On the **General** tab, in the **Service status** area, click **Start**.
- e. From the **Startup type** drop-down menu, select **Automatic**, and then click **OK**.
- f. Click **OK** to close the dialog box.

Cause: The **Lexbcservice** service installed by a Lexmark printer, Lexmark all-in-one, or Dell all-in-one, caused a scan communication error.

If this did not solve the issue, try the next solution.

Solution 9: Run the Scan Diagnostic Utility

Solution: Download and run the **Scan Diagnostic** utility to find and correct problems with your product.

To download and run the Scan Diagnostic utility

1. Go to: www.hp.com and click **Software and driver downloads**.
2. Select **Download drivers and software (and firmware)**.
3. Type your product name and model number in the field provided, and then press **Enter**.
4. Select the operating system of your computer where the HP software is installed.
5. Go to the **Utility** section and download the **HP Scan diagnostic** utility.
6. Try to scan.

If an error condition is identified with any of the HP software components, a red X is displayed next to the component. If there is no error condition, a green check mark is displayed next to the component. The utility is equipped with a **Fix** button to correct the error conditions.

Cause: There was a problem with the connection between the product and the computer.

If this did not solve the issue, try the next solution.

Solution 10: Download and install the unexpected internal error and communications failure patch

Solution: Download and install the **unexpected internal error and communications failure** patch.

This patch resolves the **An unexpected internal error has occurred** error and other communication failures with the product.

To install the patch

1. Go to: www.hp.com and click **Software and driver downloads**.
2. Select **Download drivers and software (and firmware)**.
3. Select the operating system of your computer where the HP software is installed.
4. Go to the **Patch** section and download the **HP Image zone/photo and imaging unexpected internal error and communications failure patch**.
5. Double-click the patch to install it on the computer.
6. Try to scan.

Cause: You needed to install the **unexpected internal error and communications failure** patch.

If this did not solve the issue, try the next solution.

Solution 11: Check the USB chipset and controller

Solution: Check the USB chipset and controller.

Scan communication errors can occur because of compatibility issues with USB chipsets installed on the computer. This can be caused by a mismatch in the

handshake timing between HP product chipset and certain types of USB chipsets on the computer.

To check the USB chipset and controller

1. On the Windows taskbar, click **Start**, right-click **My Computer**, and then click **Properties**.
2. Click the **Hardware** tab, and then click **Device Manager**.
3. Open **Universal Serial Bus Controllers** by clicking the plus sign (+) next to it.
4. Check if you have one of the following chipsets listed:
 - SIS 7001 USB host controller
 - ALI chipsets
 - NEC universal host controllers
 - Intel 82801 AA, Intel 82801BA/BAM



NOTE: This is not a comprehensive list. If you are experiencing communication issues while trying to scan, follow the steps below to resolve the issue.

5. Disconnect all USB devices (printers, scanners, cameras, etc.) from the computer, except the mouse or keyboard.
6. Reconnect the USB cable to the USB port on the back of the product.
7. Reconnect the other end of the USB cable to a USB port on your computer.

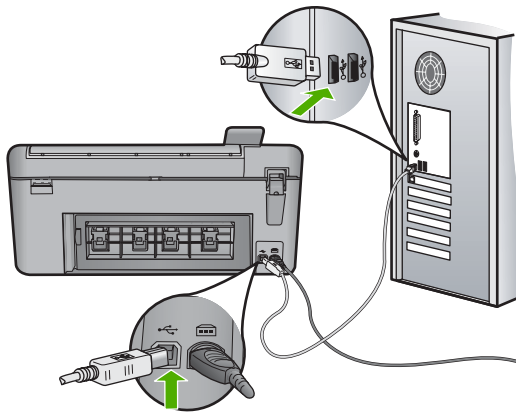

8. Make sure the power cord is firmly connected to both the product and the power adaptor. Plug the power cord into a power outlet, surge protector, or power strip.

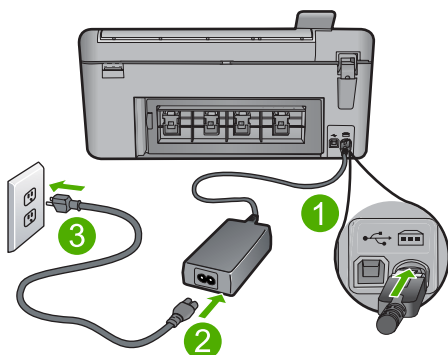

1	Power connection
2	Power cord and adaptor
3	Power outlet

9. Turn on the product.
10. Print a self-test report to test the basic standalone functionality of the product. See the following procedure for more information about printing a self-test report.
11. Try to scan.
 - If the scan is successful, other USB devices connected to the computer might be causing the problem.
12. If the scan is successful, then connect one USB device at a time to the computer.
13. Test the scanning functionality after each connection, until you identify which piece of equipment is causing the problem.
14. If the product fails to scan. Or, does not establish communication with the computer along with any of the USB devices plugged in, then connect a powered USB hub between the product and the computer.
 - This might help to establish, or to maintain, communication between the computer and the product. See the following section for more information about USB hubs.

To print a self-test report

1. Load letter or A4 unused plain white paper into the input tray.
2. Press and hold the Cancel button and then press the **Start Copy Color** button. The product prints a self-test report, which might indicate the source of the printing problem. A sample of the ink test area of the report is shown below.



3. Make sure the test patterns show a complete grid and the thick color lines are complete.
 - If more than a few lines in a pattern are broken, this might indicate a problem with the nozzles. You might need to clean the print cartridges.
 - If the black line is missing, faded, streaked, or shows lines, this might indicate a problem with the black or photo print cartridge in the right slot.
 - If any of the color lines are missing, faded, streaked, or show lines, this might indicate a problem with the tri-color print cartridge in the left slot.

More information about using a USB hub

- Verify that the USB hub is a powered hub and the power adapter is plugged in. Some powered hubs do not include the power adapter as a standard item.
- The hub must be plugged into a power source.
- Some hubs cannot handle more than four full-power USB devices. You can connect a maximum of five hubs to the system.
- If the product has trouble with a hub when the hubs are connected together, or there are more than four devices on the hub, connect the product to the hub that is directly connected to the computer (unless there are known issues).

Cause: There was a compatibility issue with USB chipsets installed on the computer.

If this did not solve the issue, try the next solution.

Solution 12: Uninstall and then reinstall the software

Solution: Uninstall the software completely, and then reinstall it.

To uninstall the software and reset the product

1. Disconnect and reset the product.

To disconnect and reset the product

- a. Make sure the product is turned on.
 - b. Press the On button to turn off the product.
 - c. Disconnect the power cord from the back of the product.
 - d. Reconnect the power cord to the back of the product.
 - e. Press the On button to turn on the product.
2. Uninstall the software completely.



NOTE: It is important that you follow the uninstall procedure carefully to ensure you have removed the software completely from the computer, before reinstalling it.

To uninstall the software completely

- a. On the Windows taskbar, click **Start, Settings, Control Panel**, (or just **Control Panel**).
- b. Double-click **Add/Remove Programs** (or click **Uninstall a program**).
- c. Remove all the items that are related to the HP Photosmart Software.

△ **CAUTION:** If the computer is manufactured by HP or Compaq, **do not** remove any applications other than those listed below.

- HP Imaging device functions
 - HP Document Viewer
 - HP Photosmart Essential
 - HP Image Zone
 - HP Photo and imaging gallery
 - HP Photosmart, Officejet, Deskjet (with the product name and software version number)
 - HP Software update
 - HP Share to Web
 - HP Solution Center
 - HP Director
 - HP Memories Disk Greeting Card Creator 32
- d. Go to C:\Program Files\HP or C:\Program Files\Hewlett-Packard (for some older products) and delete the Digital Imaging folder.
 - e. Go to C:\WINDOWS and rename the twain_32 folder to twain_32 old.

3. Turn off programs that run in the background.



NOTE: When the computer is turned on, a software group called the Terminate and Stay Resident (TSR) programs automatically loads. These programs activate some of the computer utilities, such as the anti-virus software, but are not required for the computer to function. Occasionally, TSR's prevent the HP software from loading so that it does not install properly. In Windows Vista and Windows XP, use the MSCONFIG utility to prevent TSR programs and services from starting up.

To turn off programs that run in the background

- a. On the Windows taskbar, click **Start**.
- b. Depending on your operating system, do one of the following:
 - In Windows Vista: In **Start Search**, type `MSCONFIG`, and then press **Enter**.
When the User Account Control dialog box appears, click **Continue**.
 - In Windows XP: Click **Run**. When the **Run** dialog box appears, type `MSCONFIG`, and then press **Enter**.
The **MSCONFIG** utility application appears.
- c. Click the **General** tab.
- d. Click **Selective Startup**.
- e. If there is a check mark next to **Load Startup Items**, click the check mark to remove it.
- f. Click the **Services** tab, and select the **Hide All Microsoft Services** box.
- g. Click **Disable all**.
- h. Click **Apply**, and then click **Close**.



NOTE: If you receive a message stating **Access is denied** while making changes, click **OK** and continue. The message will not prevent you from making the changes.

- i. Click **Restart** to apply the changes to the computer during the next restart. After the computer restarts, the **You've used system configuration utility to make changes to the way windows starts** message appears.
 - j. Click the check box next to **Do not show this message again**.
4. Run the **Disk Cleanup** utility to delete temporary files and folders.

To run the Disk Cleanup utility

- a. On the Windows taskbar, click **Start**, click **Programs** or **All Programs**, and then click **Accessories**.
- b. Click **System Tools**, and then click **Disk Cleanup**.
The **Disk Cleanup** analyzes the hard drive and then presents a report with a list of components to delete.

- c. Select the appropriate check boxes to remove the unnecessary components.

More information about the Disk Cleanup utility

The Disk Cleanup utility frees hard disk space on your computer by doing the following:

- Deleting temporary Internet files
- Deleting downloaded program files
- Emptying the Recycle Bin
- Deleting files from your temporary folder
- Deleting files created by other Windows tools
- Removing optional Windows components that you do not use

- d. After selecting the components to remove, click **OK**.

5. Install the software.

To install the software

- a. Insert software CD into the CD-ROM drive of the computer.
The software installation will start automatically.

 **NOTE:** If the installation does not run automatically, from the Windows **Start** menu, click **Start Search** (or **Run**). In the **Start Search** (or **Run**) dialog box, type `d:\setup.exe`, and then press **Enter**. (If your CD-ROM drive is not assigned to drive letter D, enter the appropriate drive letter.)

- b. Follow the prompts on the computer screen to install the software.

6. Try using the product again.

Cause: The software needed to be completely uninstalled and reinstalled.

Unable to print

Try the following solutions to resolve the issue. Solutions are listed in order, with the most likely solution first. If the first solution does not solve the problem, continue trying the remaining solutions until the issue is resolved.

- [Solution 1: Print a self test report](#)
- [Solution 2: Clear the print queue](#)
- [Solution 3: Disconnect and reconnect the USB cable](#)
- [Solution 4: Verify that the product is set as the default printer](#)
- [Solution 5: Check if the printer is paused or offline](#)
- [Solution 6: Clear the print queue manually](#)
- [Solution 7: Stop and restart the print spooler](#)
- [Solution 8: Verify whether the software application has a problem](#)

Solution 1: Print a self test report

Solution: Print a self-test report to see if the product can print.

To print a self-test report

1. Load letter or A4 unused plain white paper into the input tray.
2. Press **Setup**.



3. Press the down arrow button to highlight **Tools**, and then press **OK**.
4. Press the down arrow button to highlight **Self-Test Report**, and then press **OK**.
The product prints a self-test report, which might indicate the source of the printing problem. A sample of the ink test area of the report is shown below.



5. Make sure the test patterns show a complete grid and the thick color lines are complete.
 - If more than a few lines in a pattern are broken, this might indicate a problem with the nozzles. You might need to clean the print cartridges.
 - If the black line is missing, faded, streaked, or shows lines, this might indicate a problem with the black or photo print cartridge in the right slot.
 - If any of the color lines are missing, faded, streaked, or show lines, this might indicate a problem with the tri-color print cartridge in the left slot.

If the self-test report fails to print, make sure you set up the product properly. See the Start Here guide that came with the product for information about setting it up.

Cause: The product was not set up properly.

If this did not solve the issue, try the next solution.

Solution 2: Clear the print queue

Solution: Restart your computer to clear the print queue.

To clear the print queue

1. Restart your computer.
2. After the computer has restarted, check the print queue.
 - a. Depending upon your operating system, do one of the following:
 - Windows Vista: On the Windows taskbar, click **Start**, click **Control Panel**, and then click **Printers**.
 - Windows XP: On the Windows taskbar, click **Start**, click **Control Panel**, and then click **Printers and Faxes**.
 - b. Double-click the icon for your product to open the print queue.
If there are no print jobs pending, the issue might have been resolved.
3. Try to print again.

Cause: The computer needed to be restarted to clear the print queue.

If this did not solve the issue, try the next solution.

Solution 3: Disconnect and reconnect the USB cable

Solution: Disconnect the USB cable from the computer and product, and then reconnect it.

To disconnect and reconnect the USB cable

1. Disconnect the USB cable from the product.
2. Disconnect the USB cable from the computer.
3. Leave the USB cable disconnected for 5-6 seconds.
4. Reconnect the USB cable to the product and the computer.

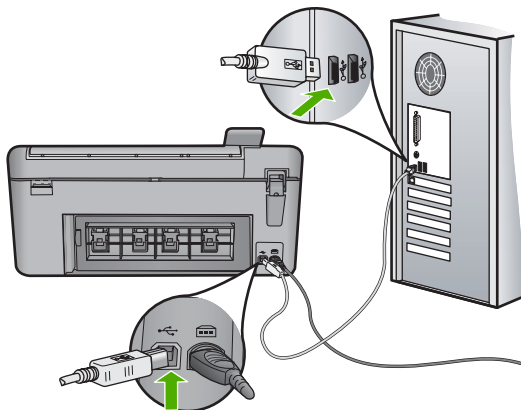

After reconnecting the USB cable, the product should start printing the jobs in queue.

 **NOTE:** If you are connecting the product through a USB hub, make sure the hub is turned on. If the hub is on, try connecting directly to your computer.

5. If the product does not start printing automatically, start another print job.

Cause: The USB cable needed to be disconnected.

If this did not solve the issue, try the next solution.

Solution 4: Verify that the product is set as the default printer

Solution: Check to make sure the product is set as the default printer and it is using the correct printer driver.

To verify that the product is set as the default printer

1. Depending upon your operating system, do one of the following:
 - Windows Vista: On the Windows taskbar, click **Start**, click **Control Panel**, and then click **Printers**.
 - Windows XP: On the Windows taskbar, click **Start**, click **Control Panel**, and then click **Printers and Faxes**.
2. Make sure the correct product is set as the default printer.
The default printer has a check mark in a black circle next to it.
3. If the wrong product is set as the default printer, right-click the correct product and select **Set as Default**.

To verify the print driver

1. Depending upon your operating system, do one of the following:
 - Windows Vista: On the Windows taskbar, click **Start**, click **Control Panel**, and then click **Printers**.
 - Windows XP: On the Windows taskbar, click **Start**, click **Control Panel**, and then click **Printers and Faxes**.
2. Right-click the icon next to the product, and select **Properties**.
3. Click the **Ports** tab to verify that the product is using the correct port.
The port that the product is using is highlighted and has a check mark next to it. The product should be set to use a DOT4 or the USB00X (where X is replaced by a number) port.
4. If the product is using the wrong port, click the correct port to select it.
The port that the product is now using is highlighted and has a check mark next to it.
5. Click the **Advanced** tab.
6. Check the driver listed in the **Driver** drop-down menu to verify that the product is using the correct driver.
The name of your product should be listed as the driver.

7. If the wrong driver is selected, select the correct driver from the **Driver** drop-down menu.
8. Click **OK** to save your changes.

Cause: The product was not be set as the default printer, or the wrong driver might have been configured.

If this did not solve the issue, try the next solution.

Solution 5: Check if the printer is paused or offline

Solution: Check to make sure the product is not paused or offline.

To check if the printer is paused or offline

1. Depending upon your operating system, do one of the following:
 - Windows Vista: On the Windows taskbar, click **Start**, click **Control Panel**, and then click **Printers**.
 - Windows XP: On the Windows taskbar, click **Start**, click **Control Panel**, and then click **Printers and Faxes**.
2. Double-click the icon for your product to open the print queue.
3. On the **Printer** menu, make sure there are no check marks next to **Pause Printing** or **Use Printer Offline**.
On the **Printer** menu, make sure there are no check marks next to **Pause Printing** or **Use Printer Offline**. If a check mark is present on either option, click the menu option to remove it. If the menu has the **Use Printer Online** option, select that option to put a check mark next to it.
4. If you made any changes, try to print again.

Cause: The product was paused or offline.

If this did not solve the issue, try the next solution.

Solution 6: Clear the print queue manually

Solution: Manually clear the print queue.

To clear the print queue manually

1. Depending upon your operating system, do one of the following:
 - Windows Vista: On the Windows taskbar, click **Start**, click **Control Panel**, and then click **Printers**.
 - Windows XP: On the Windows taskbar, click **Start**, click **Control Panel**, and then click **Printers and Faxes**.
2. Double-click the icon for your product to open the print queue.
3. On the **Printer** menu, click **Cancel all documents** or **Purge Print Document**, and then click **Yes** to confirm.

4. If there are still documents in the queue, restart the computer and try printing again after the computer has restarted.
5. Check the print queue again to make sure it is clear, and then try to print again. If the print queue is not clear, or if it is clear but jobs are still failing to print, proceed to the next solution.

Cause: The print queue needed to be manually cleared.

If this did not solve the issue, try the next solution.

Solution 7: Stop and restart the print spooler

Solution: Restart the print spooler.

To stop and restart the print spooler

1. On the Windows taskbar, click **Start**, and then click **Control Panel**.
2. Double-click **Administrative Tools**, and then double-click **Services**.
3. Scroll down the list and click **Print Spooler**, and then click **Stop** to stop the service.
4. Click **Start** to restart the service, and then click **OK**.
5. Restart the computer and try printing again after the computer has restarted.

Cause: The print spooler needed to be restarted.

If this did not solve the issue, try the next solution.

Solution 8: Verify whether the software application has a problem

Solution: Verify whether the software application is the problem.

To verify the software application

1. Close the software application and reopen it.
2. Try to print again from the software application.



NOTE: The printer might not support printing from a DOS application. Determine if the software application is Windows-based or DOS-based by checking the system requirements of the application.

3. Try printing from Notepad to see if the issue is the software application or the driver.

To print from Notepad

- a. On the Windows taskbar, click **Start**, and then click **Programs** or **All Programs**.
- b. Click **Accessories**, and then click **Notepad**.

- c. Type a few characters of text into Notepad.
 - d. Click **File**, and then click **Print**.
4. If printing is successful from Notepad but not the software application, contact the manufacturer of that application for support.

Cause: The software application was failing or could not communicate with the print driver correctly.

Product might not be correctly installed

Try the following solutions to resolve the issue. Solutions are listed in order, with the most likely solution first. If the first solution does not solve the problem, continue trying the remaining solutions until the issue is resolved.

- [Solution 1: Reset the product](#)
- [Solution 2: Check the power cord and USB cable](#)
- [Solution 3: Restart the computer](#)
- [Solution 4: Uninstall and reinstall the product](#)
- [Solution 5: Uninstall and reinstall the HP Photosmart Software](#)

Solution 1: Reset the product

Solution: Turn off the product and reset it by disconnecting the power cord. Wait 60 seconds, and then plug in the power cord. Turn on the product.

Cause: The product had to be reset.

If this did not solve the issue, try the next solution.

Solution 2: Check the power cord and USB cable

Solution: Make sure that the power cord and USB cable are properly attached and plugged in. Also, make sure that the product is turned on.

To check the power supply

1. Make sure the power cord is firmly connected to both the product and the power adaptor. Plug the power cord into a power outlet, surge protector, or power strip.

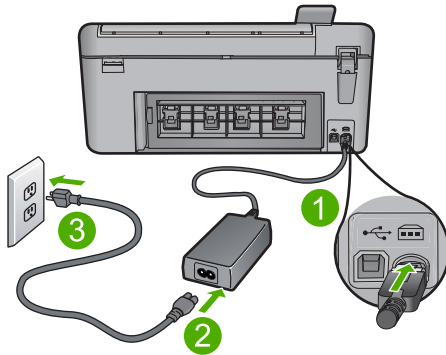

1	Power connection
2	Power cord and adaptor
3	Power outlet

2. Make sure the product is turned on.
3. If the product is not receiving electrical power, connect it to another power outlet.
4. Turn off the product and reset it by disconnecting the power cord.
5. Wait 5 seconds, and plug in the power cord.
6. Turn on the product.
7. Try to scan again.

To check the USB connection

1. Verify that the USB cable is securely plugged into the USB port on the back of the product.
2. Make sure the other end of the USB cable is plugged into a USB port on your computer.

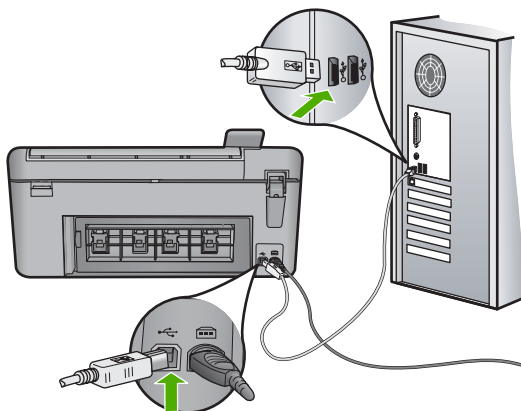

3. Try to scan again.
If the scan fails, continue to the next step.
4. Do one of the following, depending upon how the product is connected to the computer:
 - If the USB cable is connected to a USB hub, try unplugging and replugging the USB cable into the hub. If that does not work, try turning off the hub and then turning it on again. Finally, try disconnecting the cable from the hub and connecting it directly to the computer.
 - If the USB cable is connected to a docking station for a laptop, disconnect the cable from the docking station and connect it directly to the computer.
 - If the USB cable is directly connected to the computer, try plugging it into another USB port on the computer.
5. If there are other USB devices connected to the computer, disconnect the other devices, except for the keyboard and the mouse.
6. Check the USB cable to make sure it is functioning properly.

 **NOTE:** If you are using an older cable, it might not be working properly. Try connecting it to another product to see if the USB cable works. If you experience problems, the USB cable might need to be replaced. Also verify that the cable does not exceed 3 meters (9.8 feet) in length.

7. If another USB cable is available, try using that one instead.
8. Restart the computer.
9. After the computer restarts, try to scan again.

Cause: The power cord or USB cable was not attached properly.

If this did not solve the issue, try the next solution.

Solution 3: Restart the computer

Solution: Restart the computer.

Cause: You might not have restarted the computer after installing the product software. Or, there might have been another problem with the computer.

If this did not solve the issue, try the next solution.

Solution 4: Uninstall and reinstall the product

Solution: Uninstall the product from the **Printers and Faxes** control panel and then reinstall it.

To uninstall and reinstall the product

1. Disconnect the USB cable between the product and the computer.
2. On the Windows taskbar, click **Start, Printers and Faxes**.
3. Right-click the product and select **Delete**.
4. Wait several seconds, and then reconnect the product to the computer with the USB cable.
5. Follow any onscreen prompts to reinstall the product.

Cause: There might have been a problem when you originally installed the product.

If this did not solve the issue, try the next solution.

Solution 5: Uninstall and reinstall the HP Photosmart Software

Solution: Uninstall the complete HP Photosmart Software from the computer and then reinstall it using the CD that came with your product.

To uninstall and reinstall the software

1. On the Windows taskbar, click **Start, Settings, Control Panel**.
2. Double-click **Add/Remove Programs**.
3. Remove all the items that are related to the HP scanning software.
A message appears on the computer to restart after removing some programs from the **Add/Remove Programs** list.
4. Select **Click here to restart later**.
5. Disconnect the product from your computer and then restart your computer.



NOTE: It is important that you disconnect the product before restarting your computer. Do not connect the product to your computer until after you have reinstalled the software.

6. Insert the HP Photosmart CD-ROM into your computer's CD-ROM drive and then start the Setup program.



NOTE: If the Setup program does not appear, locate the setup.exe file on the CD-ROM drive and double-click it.

7. Follow the onscreen instructions and the instructions provided in the Start Here guide that came with the product.
8. If you are still having trouble scanning, remove the following additional applications from the Add/Remove Programs list, if they are present.

△ **CAUTION:** If the computer is manufactured by HP or Compaq, do **not** remove any applications other than those listed below.

- HP Imaging device functions
- HP Document Viewer
- HP Photosmart Essential
- HP Image Zone
- HP Photo and imaging gallery
- HP Photosmart, Officejet, Deskjet, (with product name and software version number)
- HP Software update
- HP Share to web
- HP Solution Center
- HP Director
- HP Memories Disk Greeting Card Creator 32

Cause: There might have been a problem when you originally installed the HP Photosmart Software.

Product was not found

Try the following solutions to resolve the issue. Solutions are listed in order, with the most likely solution first. If the first solution does not solve the problem, continue trying the remaining solutions until the issue is resolved.

- [Solution 1: Reset the product](#)
- [Solution 2: Check the power cord and USB cable](#)
- [Solution 3: Restart the computer](#)
- [Solution 4: Uninstall and reinstall the product](#)
- [Solution 5: Uninstall and reinstall the HP Photosmart Software](#)

Solution 1: Reset the product

Solution: Turn off the product and reset it by disconnecting the power cord. Wait 60 seconds, and then plug in the power cord. Turn on the product.

Cause: You needed to reset the product.

If this did not solve the issue, try the next solution.

Solution 2: Check the power cord and USB cable

Solution: Make sure that the power cord and USB cable are properly attached and plugged in. Also, make sure that the product is turned on.

To check the power supply

1. Make sure the power cord is firmly connected to both the product and the power adaptor. Plug the power cord into a power outlet, surge protector, or power strip.

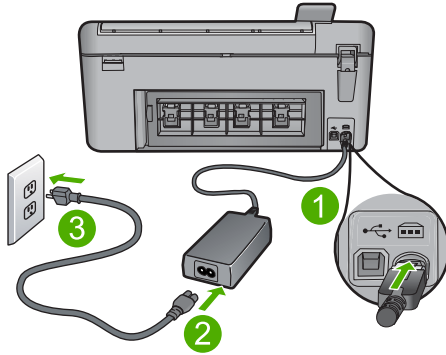

1	Power connection
2	Power cord and adaptor
3	Power outlet

2. Make sure the product is turned on.
3. If the product is not receiving electrical power, connect it to another power outlet.
4. Turn off the product and reset it by disconnecting the power cord.
5. Wait 5 seconds, and plug in the power cord.
6. Turn on the product.
7. Try to scan again.

To check the USB connection

1. Verify that the USB cable is securely plugged into the USB port on the back of the product.
2. Make sure the other end of the USB cable is plugged into a USB port on your computer.

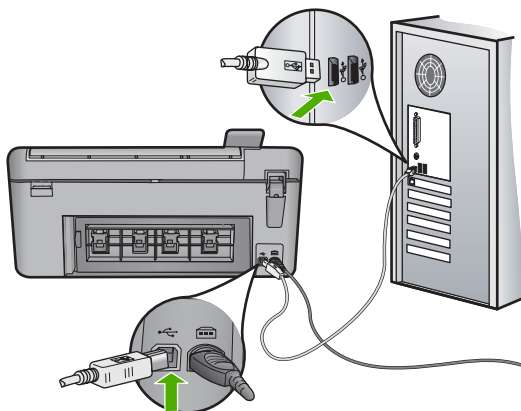

3. Try to scan again.
If the scan fails, continue to the next step.
4. Do one of the following, depending upon how the product is connected to the computer:
 - If the USB cable is connected to a USB hub, try unplugging and replugging the USB cable into the hub. If that does not work, try turning off the hub and then turning it on again. Finally, try disconnecting the cable from the hub and connecting it directly to the computer.
 - If the USB cable is connected to a docking station for a laptop, disconnect the cable from the docking station and connect it directly to the computer.
 - If the USB cable is directly connected to the computer, try plugging it into another USB port on the computer.
5. If there are other USB devices connected to the computer, disconnect the other devices, except for the keyboard and the mouse.
6. Check the USB cable to make sure it is functioning properly.

 **NOTE:** If you are using an older cable, it might not be working properly. Try connecting it to another product to see if the USB cable works. If you experience problems, the USB cable might need to be replaced. Also verify that the cable does not exceed 3 meters (9.8 feet) in length.

7. If another USB cable is available, try using that one instead.
8. Restart the computer.
9. After the computer restarts, try to scan again.

Cause: The power cord or USB cable was not attached properly.

If this did not solve the issue, try the next solution.

Solution 3: Restart the computer

Solution: Restart the computer.

Cause: You might not have restarted the computer after installing the product software. Or, there might have been another problem with the computer.

If this did not solve the issue, try the next solution.

Solution 4: Uninstall and reinstall the product

Solution: Uninstall the product from the **Printers and Faxes** control panel and then reinstall it.

To uninstall and reinstall the product

1. Disconnect the USB cable between the product and the computer.
2. On the Windows taskbar, click **Start, Printers and Faxes**.
3. Right-click the product and select **Delete**.
4. Wait several seconds, and then reconnect the product to the computer with the USB cable.
5. Follow any onscreen prompts to reinstall the product.

Cause: There might have been a problem when you originally installed the product.

If this did not solve the issue, try the next solution.

Solution 5: Uninstall and reinstall the HP Photosmart Software

Solution: Uninstall the complete HP Photosmart Software from the computer and then reinstall it using the CD that came with your product.

To uninstall and reinstall the software

1. On the Windows taskbar, click **Start, Settings, Control Panel**.
2. Double-click **Add/Remove Programs**.
3. Remove all the items that are related to the HP scanning software.
A message appears on the computer to restart after removing some programs from the **Add/Remove Programs** list.
4. Select **Click here to restart later**.
5. Disconnect the product from your computer and then restart your computer.



NOTE: It is important that you disconnect the product before restarting your computer. Do not connect the product to your computer until after you have reinstalled the software.

6. Insert the HP Photosmart CD-ROM into your computer's CD-ROM drive and then start the Setup program.



NOTE: If the Setup program does not appear, locate the setup.exe file on the CD-ROM drive and double-click it.

7. Follow the onscreen instructions and the instructions provided in the Start Here guide that came with the product.
8. If you are still having trouble scanning, remove the following additional applications from the Add/Remove Programs list, if they are present.

△ **CAUTION:** If the computer is manufactured by HP or Compaq, do **not** remove any applications other than those listed below.

- HP Imaging device functions
- HP Document Viewer
- HP Photosmart Essential
- HP Image Zone
- HP Photo and imaging gallery
- HP Photosmart, Officejet, Deskjet, (with product name and software version number)
- HP Software update
- HP Share to web
- HP Solution Center
- HP Director
- HP Memories Disk Greeting Card Creator 32

Cause: There might have been a problem when you originally installed the HP Photosmart Software.

Product could not find available scan destinations

Try the following solutions to resolve the issue. Solutions are listed in order, with the most likely solution first. If the first solution does not solve the problem, continue trying the remaining solutions until the issue is resolved.

- [Solution 1: Restart the computer](#)
- [Solution 2: Uninstall and reinstall the HP Photosmart Software](#)

Solution 1: Restart the computer

Solution: Restart the computer.

Cause: You might not have restarted the computer after installing the product software. Or, there might have been another problem with the computer.

If this did not solve the issue, try the next solution.

Solution 2: Uninstall and reinstall the HP Photosmart Software

Solution: Uninstall the complete HP Photosmart Software from the computer and then reinstall it using the CD that came with your product.

To uninstall and reinstall the software

1. On the Windows taskbar, click **Start, Settings, Control Panel**.
2. Double-click **Add/Remove Programs**.

3. Remove all the items that are related to the HP scanning software.
A message appears on the computer to restart after removing some programs from the **Add/Remove Programs** list.
4. Select **Click here to restart later**.
5. Disconnect the product from your computer and then restart your computer.



NOTE: It is important that you disconnect the product before restarting your computer. Do not connect the product to your computer until after you have reinstalled the software.

6. Insert the HP Photosmart CD-ROM into your computer's CD-ROM drive and then start the Setup program.



NOTE: If the Setup program does not appear, locate the setup.exe file on the CD-ROM drive and double-click it.

7. Follow the onscreen instructions and the instructions provided in the Start Here guide that came with the product.
8. If you are still having trouble scanning, remove the following additional applications from the Add/Remove Programs list, if they are present.



CAUTION: If the computer is manufactured by HP or Compaq, do **not** remove any applications other than those listed below.

- HP Imaging device functions
- HP Document Viewer
- HP Photosmart Essential
- HP Image Zone
- HP Photo and imaging gallery
- HP Photosmart, Officejet, Deskjet, (with product name and software version number)
- HP Software update
- HP Share to web
- HP Solution Center
- HP Director
- HP Memories Disk Greeting Card Creator 32

Cause: There might have been a problem when you originally installed the HP Photosmart Software.

Required software component was not found or was incorrectly installed

Solution: Uninstall the complete HP Photosmart Software from the computer and then reinstall it using the CD that came with your product.

To uninstall and reinstall the software

1. On the Windows taskbar, click **Start, Settings, Control Panel**.
2. Double-click **Add/Remove Programs**.

3. Remove all the items that are related to the HP scanning software.
A message appears on the computer to restart after removing some programs from the **Add/Remove Programs** list.
4. Select **Click here to restart later**.
5. Disconnect the product from your computer and then restart your computer.

 **NOTE:** It is important that you disconnect the product before restarting your computer. Do not connect the product to your computer until after you have reinstalled the software.

6. Insert the HP Photosmart CD-ROM into your computer's CD-ROM drive and then start the Setup program.

 **NOTE:** If the Setup program does not appear, locate the setup.exe file on the CD-ROM drive and double-click it.

7. Follow the onscreen instructions and the instructions provided in the Start Here guide that came with the product.
8. If you are still having trouble scanning, remove the following additional applications from the Add/Remove Programs list, if they are present.

 **CAUTION:** If the computer is manufactured by HP or Compaq, do **not** remove any applications other than those listed below.

- HP Imaging device functions
- HP Document Viewer
- HP Photosmart Essential
- HP Image Zone
- HP Photo and imaging gallery
- HP Photosmart, Officejet, Deskjet, (with product name and software version number)
- HP Software update
- HP Share to web
- HP Solution Center
- HP Director
- HP Memories Disk Greeting Card Creator 32

Cause: There might have been a problem when you originally installed the HP Photosmart Software.

Error occurred while communicating with the product

Try the following solutions to resolve the issue. Solutions are listed in order, with the most likely solution first. If the first solution does not solve the problem, continue trying the remaining solutions until the issue is resolved.

- [Solution 1: Reset the product](#)
- [Solution 2: Check the power cord and USB cable](#)
- [Solution 3: Restart the computer](#)
- [Solution 4: Uninstall and reinstall the product](#)

- [Solution 5: Uninstall and reinstall the HP Photosmart Software](#)
- [Solution 6: Contact HP support for service](#)

Solution 1: Reset the product

Solution: Turn off the product and reset it by disconnecting the power cord. Wait 60 seconds, and then plug in the power cord. Turn on the product.

Cause: You needed to reset the product.

If this did not solve the issue, try the next solution.

Solution 2: Check the power cord and USB cable

Solution: Make sure that the power cord and USB cable are properly attached and plugged in. Also, make sure that the product is turned on.

To check the power supply

1. Make sure the power cord is firmly connected to both the product and the power adaptor. Plug the power cord into a power outlet, surge protector, or power strip.

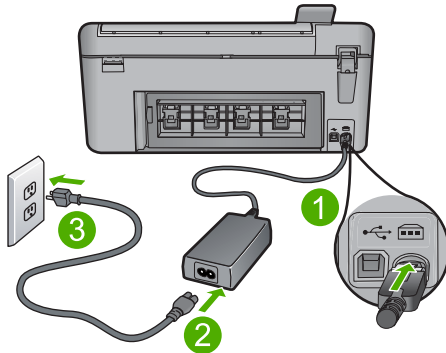

1	Power connection
2	Power cord and adaptor
3	Power outlet

2. Make sure the product is turned on.
3. If the product is not receiving electrical power, connect it to another power outlet.
4. Turn off the product and reset it by disconnecting the power cord.
5. Wait 5 seconds, and plug in the power cord.
6. Turn on the product.
7. Try to scan again.

To check the USB connection

1. Verify that the USB cable is securely plugged into the USB port on the back of the product.
2. Make sure the other end of the USB cable is plugged into a USB port on your computer.

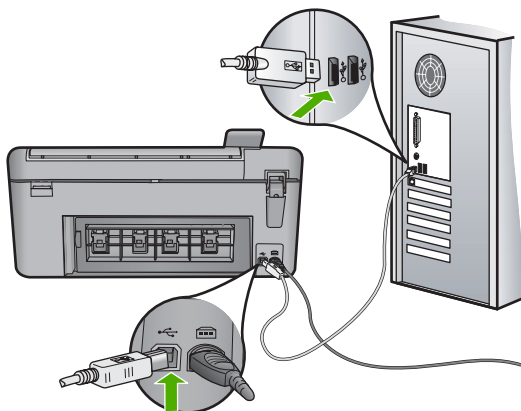

3. Try to scan again.
If the scan fails, continue to the next step.
4. Do one of the following, depending upon how the product is connected to the computer:
 - If the USB cable is connected to a USB hub, try unplugging and replugging the USB cable into the hub. If that does not work, try turning off the hub and then turning it on again. Finally, try disconnecting the cable from the hub and connecting it directly to the computer.
 - If the USB cable is connected to a docking station for a laptop, disconnect the cable from the docking station and connect it directly to the computer.
 - If the USB cable is directly connected to the computer, try plugging it into another USB port on the computer.
5. If there are other USB devices connected to the computer, disconnect the other devices, except for the keyboard and the mouse.
6. Check the USB cable to make sure it is functioning properly.

 **NOTE:** If you are using an older cable, it might not be working properly. Try connecting it to another product to see if the USB cable works. If you experience problems, the USB cable might need to be replaced. Also verify that the cable does not exceed 3 meters (9.8 feet) in length.

7. If another USB cable is available, try using that one instead.
8. Restart the computer.
9. After the computer restarts, try to scan again.

Cause: The power cord or USB cable was not attached properly.

If this did not solve the issue, try the next solution.

Solution 3: Restart the computer

Solution: Restart the computer.

Cause: You might not have restarted the computer after installing the product software. Or, there might have been another problem with the computer.

If this did not solve the issue, try the next solution.

Solution 4: Uninstall and reinstall the product

Solution: Uninstall the product from the **Printers and Faxes** control panel and then reinstall it.

To uninstall and reinstall the product

1. Disconnect the USB cable between the product and the computer.
2. On the Windows taskbar, click **Start, Printers and Faxes**.
3. Right-click the product and select **Delete**.
4. Wait several seconds, and then reconnect the product to the computer with the USB cable.
5. Follow any onscreen prompts to reinstall the product.

Cause: There might have been a problem when you originally installed the product.

If this did not solve the issue, try the next solution.

Solution 5: Uninstall and reinstall the HP Photosmart Software

Solution: Uninstall the complete HP Photosmart Software from the computer and then reinstall it using the CD that came with your product.

To uninstall and reinstall the software

1. On the Windows taskbar, click **Start, Settings, Control Panel**.
2. Double-click **Add/Remove Programs**.
3. Remove all the items that are related to the HP scanning software.
A message appears on the computer to restart after removing some programs from the **Add/Remove Programs** list.
4. Select **Click here to restart later**.
5. Disconnect the product from your computer and then restart your computer.



NOTE: It is important that you disconnect the product before restarting your computer. Do not connect the product to your computer until after you have reinstalled the software.

6. Insert the HP Photosmart CD-ROM into your computer's CD-ROM drive and then start the Setup program.



NOTE: If the Setup program does not appear, locate the setup.exe file on the CD-ROM drive and double-click it.

7. Follow the onscreen instructions and the instructions provided in the Start Here guide that came with the product.
8. If you are still having trouble scanning, remove the following additional applications from the Add/Remove Programs list, if they are present.

△ **CAUTION:** If the computer is manufactured by HP or Compaq, do **not** remove any applications other than those listed below.

- HP Imaging device functions
- HP Document Viewer
- HP Photosmart Essential
- HP Image Zone
- HP Photo and imaging gallery
- HP Photosmart, Officejet, Deskjet, (with product name and software version number)
- HP Software update
- HP Share to web
- HP Solution Center
- HP Director
- HP Memories Disk Greeting Card Creator 32

Cause: There might have been a problem when you originally installed the HP Photosmart Software.

If this did not solve the issue, try the next solution.

Solution 6: Contact HP support for service

Solution: If you have completed all of the steps provided in the previous solutions and are still having a problem, contact HP support for service.

Go to: www.hp.com/support.

If prompted, choose your country/region, and then click **Contact HP** for technical support.

Cause: You might need assistance to enable the product or software to function properly.

Missing HP Photosmart Software

Try the following solutions to resolve the issue. Solutions are listed in order, with the most likely solution first. If the first solution does not solve the problem, continue trying the remaining solutions until the issue is resolved.

- [Solution 1: Install the HP Photosmart Software](#)
- [Solution 2: Turn on the product](#)
- [Solution 3: Turn on the computer](#)
- [Solution 4: Check the connection from the product to your computer](#)

Solution 1: Install the HP Photosmart Software

Solution: Install the HP Photosmart Software that came with the product. If it is installed, restart your computer.

To install the HP Photosmart Software

1. Insert the product CD-ROM into your computer's CD-ROM drive and then start the Setup program.
2. When prompted, click **Install More Software** to install the HP Photosmart Software.
3. Follow the onscreen instructions and the instructions provided in the Start Here guide that came with the product.

Cause: The HP Photosmart Software was not installed.

If this did not solve the issue, try the next solution.

Solution 2: Turn on the product

Solution: Turn on the product.

Cause: The product was turned off.

If this did not solve the issue, try the next solution.

Solution 3: Turn on the computer

Solution: Turn on the computer

Cause: The computer was turned off.

If this did not solve the issue, try the next solution.

Solution 4: Check the connection from the product to your computer

Solution: Check the connection from the product to your computer. Verify that the USB cable is securely plugged into the USB port on the back of the product. Make sure the other end of the USB cable is plugged into a USB port on your computer. After the cable is connected properly, turn off the product and then on again. If the

product is connected to the computer through a Bluetooth connection, make sure that the connection is active and the product is turned on.

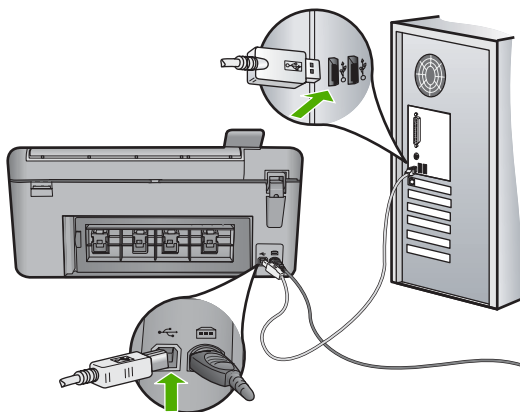

For more information on setting up the product and connecting it to your computer, see the Start Here guide that came with the product.

Cause: The product was not properly connected to the computer.

File messages

The following is a list of file-related error messages:

- [Error reading or writing the file](#)
- [Unreadable files. NN files could not be read](#)
- [Photos not found](#)
- [File not found](#)
- [File format not supported](#)
- [Invalid file name](#)
- [Supported file types for the product](#)
- [File corrupted](#)

Error reading or writing the file

Solution: Check to see if you have the right folder and file name.

Cause: The product software could not open or save the file.

Unreadable files. NN files could not be read

Solution: Reinsert the memory card in the product. If this does not work, retake the photos with your digital camera. If you already transferred the files to your computer, try printing those files by using the HP Photosmart Software. The copies might not be damaged.

Cause: Some of the files on the inserted memory card were damaged.

Photos not found

Try the following solutions to resolve the issue. Solutions are listed in order, with the most likely solution first. If the first solution does not solve the problem, continue trying the remaining solutions until the issue is resolved.

- [Solution 1: Reinsert the memory card](#)
- [Solution 2: Print photos from the computer](#)

Solution 1: Reinsert the memory card

Solution: Reinsert the memory card. If this does not work, retake the photos with your digital camera. If you already transferred the files to your computer, try printing those files by using the HP Photosmart Software. The copies might not be damaged.

Cause: Some of the files on the inserted memory card were damaged.

If this did not solve the issue, try the next solution.

Solution 2: Print photos from the computer

Solution: Take some photos with your digital camera, or if you previously saved photos on your computer, you can print them using the HP Photosmart Software.

Cause: No photos were found on the memory card.

File not found

Solution: Close some applications and try the task again.

Cause: There was not enough available memory on your computer to create a print preview file.

File format not supported

Solution: Open the file in another application, and save it in a format that the HP software recognizes.

Cause: The HP software did not recognize or support the file format of the image you are trying to open or save. If the file extension indicates it is a supported file type, the file might be corrupted.

Invalid file name

Solution: Make sure that you are not using any invalid symbols in the file name.

Cause: The file name you entered was invalid.

Supported file types for the product

The product software only recognizes JPG and TIF images.

File corrupted

Try the following solutions to resolve the issue. Solutions are listed in order, with the most likely solution first. If the first solution does not solve the problem, continue trying the remaining solutions until the issue is resolved.

- [Solution 1: Reinsert the memory card in the product](#)
- [Solution 2: Reformat the memory card in your digital camera.](#)

Solution 1: Reinsert the memory card in the product

Solution: Reinsert the memory card in the product. If this does not work, retake the photos with your digital camera. If you already transferred the files to your computer, try printing those files by using the HP Photosmart Software. The copies might not be damaged.

Cause: Some of the files on the inserted memory card were damaged.

If this did not solve the issue, try the next solution.

Solution 2: Reformat the memory card in your digital camera.

Solution: Check the computer screen for an error message telling you that the images on the memory card are corrupted.

If the file system on the card is corrupt, reformat the memory card in your digital camera.

△ **CAUTION:** Reformatting the memory card will delete any photos stored on the card. If you have previously transferred the photos from your memory card to a computer, try printing the photos from the computer. Otherwise, you will need to retake any photos you might have lost.

Cause: The memory card file system was corrupted.

General user messages

The following is a list of messages related to common user errors:

- [Memory card error](#)
- [Cannot crop](#)
- [Borderless printing error](#)
- [Disconnected](#)
- [Out of disk space](#)
- [Card access error](#)
- [Use only one card at a time](#)
- [Card is inserted incorrectly](#)
- [Card is damaged](#)
- [Card is not fully inserted](#)
- [CD/DVD is upside down](#)

- [CD/DVD printing problem](#)
- [CD/DVD size mismatch](#)

Memory card error

Try the following solutions to resolve the issue. Solutions are listed in order, with the most likely solution first. If the first solution does not solve the problem, continue trying the remaining solutions until the issue is resolved.

- [Solution 1: Remove all but one memory card](#)
- [Solution 2: Remove the memory card and reinsert it correctly](#)
- [Solution 3: Push the memory card all the way forward](#)

Solution 1: Remove all but one memory card

Solution: Remove all but one memory card. The product reads the remaining memory card and displays the first photo stored on the memory card.

Cause: There were two or more memory cards inserted into the product at the same time.

If this did not solve the issue, try the next solution.

Solution 2: Remove the memory card and reinsert it correctly

Solution: Remove the memory card and reinsert it correctly. The label of the memory card faces up and should be readable as you insert it into the slot.

Cause: You had inserted the memory card backwards or upside down.

If this did not solve the issue, try the next solution.

Solution 3: Push the memory card all the way forward

Solution: Remove the memory card and reinsert it in the memory card slot until it stops.

Cause: You had not fully inserted the memory card.

Cannot crop

Try the following solutions to resolve the issue. Solutions are listed in order, with the most likely solution first. If the first solution does not solve the problem, continue trying the remaining solutions until the issue is resolved.

- [Solution 1: Close some applications or restart your computer](#)
- [Solution 2: Empty the Recycle Bin on your desktop](#)

Solution 1: Close some applications or restart your computer

Solution: Close all unnecessary applications. This includes applications that run in the background, such as screensavers and virus checkers. (If you turn off your virus checker, remember to turn it back on after you finish.) Try restarting your computer

to clear the memory. You might need to purchase more RAM. Refer to the documentation that came with your computer.

Cause: The computer did not have enough memory.
If this did not solve the issue, try the next solution.

Solution 2: Empty the Recycle Bin on your desktop

Solution: Empty the Recycle Bin on your desktop. You might also need to remove files from the hard disk; for example, delete temporary files.

Cause: For scanning, there must be at least 50 MB of space available on your computer's hard disk.

Borderless printing error

Solution: Borderless printing cannot occur with only the black print cartridge installed. Install the tri-color print cartridge.

For more information, see:

[“Replace the print cartridges” on page 99](#)

Cause: The product was in ink-backup mode with only the black print cartridge installed, and a borderless print job was initiated.

Disconnected

Solution: Make sure your product is turned on and connected to your computer.

Cause: Your product was not turned on.

Out of disk space

Solution: Close some applications and try the task again.

Cause: There was not enough available memory on your computer to perform the task.

Card access error

Try the following solutions to resolve the issue. Solutions are listed in order, with the most likely solution first. If the first solution does not solve the problem, continue trying the remaining solutions until the issue is resolved.

- [Solution 1: Remove all but one memory card](#)
- [Solution 2: Remove the memory card and reinsert it correctly](#)
- [Solution 3: Push the memory card all the way forward](#)

Solution 1: Remove all but one memory card

Solution: Remove all but one memory card. The product reads the remaining memory card and displays the first photo stored on the memory card.

Cause: There were two or more memory cards inserted into the product at the same time.

If this did not solve the issue, try the next solution.

Solution 2: Remove the memory card and reinsert it correctly

Solution: Remove the memory card and reinsert it correctly. The label of the Compact Flash card faces up and should be readable as you insert it into the slot.

Cause: You had inserted the Compact Flash memory card backwards or upside down.

If this did not solve the issue, try the next solution.

Solution 3: Push the memory card all the way forward

Solution: Remove the memory card and reinsert it in the memory card slot until it stops.

Cause: You had not fully inserted the memory card.

Use only one card at a time

Solution: You can insert only one memory card at a time.

If more than one memory card is inserted, the green Photo light (near the memory card slots) will blink rapidly, and an error message will appear on the computer screen. Remove the additional memory card to resolve the problem.

Cause: Multiple memory cards were inserted in the product.

Card is inserted incorrectly

Solution: Turn the memory card so that the label faces up and the contacts are facing the product, and then push the card forward into the appropriate slot until the Photo light turns on.

If the memory card is not inserted properly, the product will not respond and the green Photo light (near the memory card slots) will blink rapidly.

After the memory card has been inserted properly, the Photo light will blink green for a few seconds, and then remain lit.

Cause: The memory card was inserted backwards or upside down.

Card is damaged

Solution: Reformat your memory card in your camera or format your memory card in a Windows XP computer by selecting the FAT format. For more information, see the documentation that came with your digital camera.

△ **CAUTION:** Reformatting the memory card will delete any photos stored on the card. If you have previously transferred the photos from your memory card to a computer, try printing the photos from the computer. Otherwise, you will need to retake any photos you might have lost.

Cause: You formatted the card on a Windows XP computer. By default, Windows XP formats a memory card of 8 MB or less and 64 MB or more with the FAT32 format. Digital cameras and other products use the FAT (FAT16 or FAT12) format and cannot recognize a FAT32 formatted card.

Card is not fully inserted

Solution: Make sure you fully insert the memory card into the appropriate slot on the product.

If the memory card is not inserted properly, the product will not respond and the green Photo light (near the memory card slots) will blink rapidly.

After the memory card has been inserted properly, the Photo light will blink green for a few seconds, and then remain lit.

Cause: The memory card was not fully inserted.

CD/DVD is upside down

Solution: Make sure the CD/DVD is snapped onto the CD/DVD holder with the printable label side up.

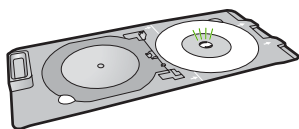

Cause: The CD/DVD was loaded upside down on the CD/DVD holder.

CD/DVD printing problem

Solution: Make sure that there is sufficient space behind the product and that the CD/DVD exit slot on the back of the product is not blocked. If the product is placed close to a wall, move it at least 7.5 cm (3 inches) away from the wall.

Cause: The product stalled while printing.

CD/DVD size mismatch

Solution: Replace the CD/DVD currently loaded on the CD/DVD holder with a CD/DVD that is the same size as specified in the print job, or cancel the print job and start again to specify the correct size in the software.

Cause: The size of the CD/DVD currently loaded on the CD/DVD holder did not match the size you specified when you started the print job from the computer.

Paper messages

The following is a list of paper-related error messages:

- [Paper upside down](#)
- [Paper orientation error](#)
- [Cannot load paper from input tray](#)
- [Ink is drying](#)
- [Out of paper](#)
- [Paper jam or misfeed](#)
- [Paper mismatch](#)
- [Wrong paper width](#)

Paper upside down

Solution: Load paper in the input tray print side down.

Cause: Paper in the input tray was upside down.

Paper orientation error

Solution: Insert paper into the input tray with the short edge forward and the print side down. Slide the paper forward until it stops.

Cause: Paper in the input tray was in landscape orientation.

Cannot load paper from input tray

Solution: If the product is out of paper or there are only a few sheets remaining, load more paper in the input tray. If there is paper in the input tray, remove the paper, tap the stack of paper against a flat surface, and reload the paper into the input tray. Press the button next to **OK** to continue your print job.

Cause: There was not enough paper in the input tray.

Ink is drying

Solution: Leave the sheet in the output tray until the message disappears. If it is necessary to remove the printed sheet before the message disappears, carefully hold the printed sheet on the underside or the edges, and place it on a flat surface to dry.

Cause: Transparencies and some other media require a drying time that is longer than normal.

Out of paper

Try the following solutions to resolve the issue. Solutions are listed in order, with the most likely solution first. If the first solution does not solve the problem, continue trying the remaining solutions until the issue is resolved.

- [Solution 1: Replace the rear door](#)
- [Solution 2: Make sure the paper is loaded correctly](#)
- [Solution 3: Check the print settings](#)
- [Solution 4: Clean the paper feed rollers with the HP Paper Feed Cleaning Kit](#)
- [Solution 5: Clean the rollers](#)
- [Solution 6: Contact HP support for service](#)

Solution 1: Replace the rear door

Solution: If you removed the rear door to clear a paper jam, replace it. Gently push the door forward until it snaps into place.

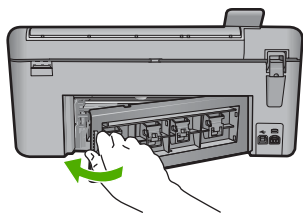

Cause: The rear door was removed from the product.
If this did not solve the issue, try the next solution.

Solution 2: Make sure the paper is loaded correctly

Solution: Make sure that the paper is loaded correctly in the input tray.

For more information, see:

[“Load paper” on page 37](#)

Cause: The paper was not loaded correctly.

If this did not solve the issue, try the next solution.

Solution 3: Check the print settings

Solution: Check the print settings.

- Check the paper type setting to make sure it matches the type of paper loaded in the input tray.
- Check the quality setting. Use a higher quality setting to increase the amount of ink used for printing.

For more information, see:

- “[Set the paper type for printing](#)” on page 53
- “[Change the print speed or quality](#)” on page 54
- “[Print using Maximum dpi](#)” on page 60
- “[Change copy speed or quality](#)” on page 88

Cause: The paper type or print quality settings were set incorrectly.

If this did not solve the issue, try the next solution.

Solution 4: Clean the paper feed rollers with the HP Paper Feed Cleaning Kit

Solution: Some inkjet products require a special kit, called the HP Paper Feed Cleaning Kit, to clean the paper feed rollers and resolve this issue. To see if this affects your product, go to: www.hp.com/support.

Search for "HP Paper Feed Cleaning Kit" for more information about this kit and to check whether it is required for your product.

Cause: The paper feed rollers were dirty and needed to be cleaned with the HP Paper Feed Cleaning Kit.

If this did not solve the issue, try the next solution.

Solution 5: Clean the rollers

Solution: Clean the rollers.

Make sure you have the following materials available:

- Lint-free cloth, or any soft material that will not come apart or leave fibers.
- Distilled, filtered, or bottled water.

To clean the rollers

1. Turn off the product and remove the power cord.
2. Press in the tab on the left side of the rear door to release the door. Remove the door by pulling it away from the product.

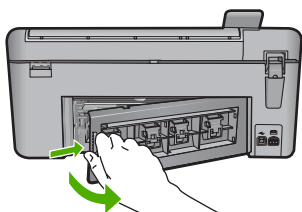

3. Dip the lint-free cloth into the purified or distilled water, and squeeze any excess water from it.
4. Clean the rubber rollers to remove any dust or dirt buildup.
5. Replace the rear door. Gently push the door forward until it snaps into place.
6. Plug the power cord back in, and turn on the product.
7. Try to print again.

Cause: The rollers were dirty and needed to be cleaned.

If this did not solve the issue, try the next solution.

Solution 6: Contact HP support for service

Solution: If you have completed all of the steps provided in the previous solutions and are still having a problem, contact HP support for service.

Go to: www.hp.com/support.

If prompted, choose your country/region, and then click **Contact HP** for technical support.

Cause: You might need assistance to enable the product or software to function properly.

Paper jam or misfeed

Solution: In case of a paper jam, check the rear door. You might need to clear the paper jam from the rear door.

To clear a paper jam from the rear door

1. Press in the tab on the left side of the rear door to release the door. Remove the door by pulling it away from the product.

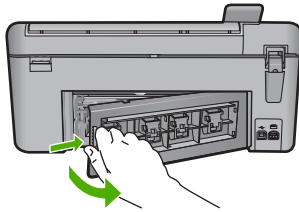

2. Gently pull the paper out of the rollers.

△ **CAUTION:** If the paper tears when you are removing it from the rollers, check the rollers and wheels for torn pieces of paper that might be remaining inside the product. If you do not remove all the pieces of paper from the product, more paper jams are likely to occur.

3. Replace the rear door. Gently push the door forward until it snaps into place.

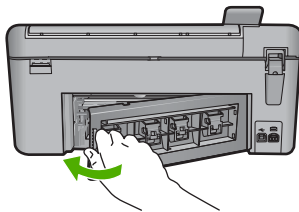

4. Press the button next to **OK** to continue the current job.

Cause: Paper had jammed in the product.

Paper mismatch

Solution: Change the print setting or load the appropriate paper in the input tray.

- Do not use paper that is too thin, that has a slick texture, or that stretches easily. It can feed incorrectly through the paper path, causing paper jams.
- Store photo media in its original packaging inside a resealable plastic bag on a flat surface in a cool, dry place. When you are ready to print, remove only the paper you plan to use immediately. When you have finished printing, return any unused photo paper to the plastic bag.
- Always hold photo paper by the edges. Fingerprints on photo paper can reduce print quality.
- Do not use paper that is heavily textured. It can cause graphics or text to print improperly.

- Do not combine different paper types and paper sizes in the input tray; the entire stack of paper in the input tray must be the same size and type.
- Store printed photos under glass or in a storage book to prevent bleeding over time from high humidity.

For more information, see:

- [“Set the paper type for printing” on page 53](#)
- [“Set the paper size” on page 52](#)

Cause: The print setting for the print job did not match the paper type or size loaded in the product.

Wrong paper width

Solution: Change the print setting or load the appropriate paper in the input tray.

For more information, see:

[“Set the paper type for printing” on page 53](#)

Cause: The print setting chosen for the print job did not match the paper loaded in the product.

Power and connection messages

The following is a list of power- and connection-related error messages:

- [Product not found](#)
- [Communication test failed](#)
- [Improper shutdown](#)
- [Two-way communication lost](#)

Product not found

Solution: If the product is not properly connected to the computer, communication errors might occur. Make sure the USB cable is securely connected to the product and the computer, as shown below.

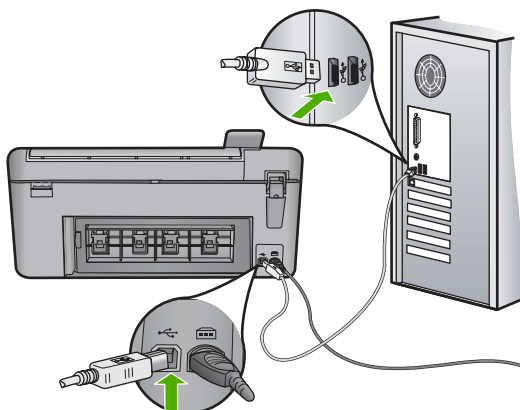

Cause: The USB cable was not plugged in properly.

Communication test failed

Try the following solutions to resolve the issue. Solutions are listed in order, with the most likely solution first. If the first solution does not solve the problem, continue trying the remaining solutions until the issue is resolved.

- [Solution 1: Turn on the product](#)
- [Solution 2: Connect the product to the computer](#)

Solution 1: Turn on the product

Solution: Look at the display on the product. If the display is blank and the On light is not lit, the product is turned off. Make sure the power cord is firmly connected to the product and plugged into a power outlet. Press the On button to turn on the product.

Cause: The product was turned off.

If this did not solve the issue, try the next solution.

Solution 2: Connect the product to the computer

Solution: If the product is not properly connected to the computer, communication errors can occur. Make sure the USB cable is securely connected to the product and the computer, as shown below.

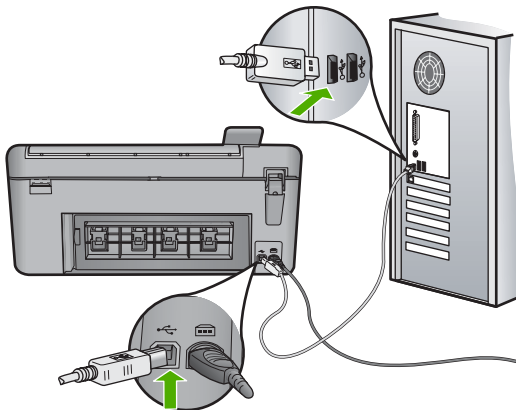

Cause: The product was not connected to the computer.

Improper shutdown

Solution: Press the On button to turn the product on and off.

Cause: The last time the product was used, it was not turned off properly. If the product is turned off by turning off the switch on a power strip or by using a wall switch, the product might be damaged.

Two-way communication lost

Try the following solutions to resolve the issue. Solutions are listed in order, with the most likely solution first. If the first solution does not solve the problem, continue trying the remaining solutions until the issue is resolved.

- [Solution 1: Turn on the product](#)
- [Solution 2: Connect the product to the computer](#)

Solution 1: Turn on the product

Solution: Look at the display on the product. If the display is blank and the On light is not lit, the product is turned off. Make sure the power cord is firmly connected to the product and plugged into a power outlet. Press the On button to turn on the product.

Cause: The product was turned off.

If this did not solve the issue, try the next solution.

Solution 2: Connect the product to the computer

Solution: If the product is not properly connected to the computer, communication errors can occur. Make sure the USB cable is securely connected to the product and the computer, as shown below.

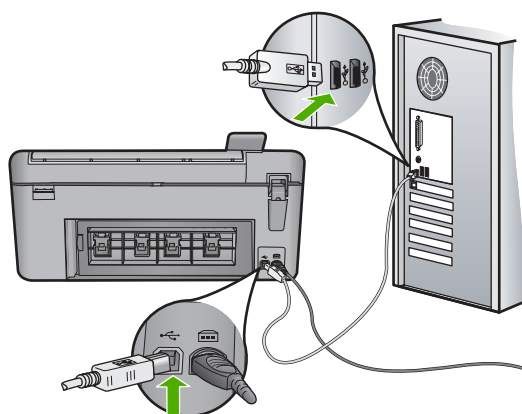

Cause: The product was not connected to the computer.

Print cartridge messages

The following is a list of print cartridge error messages:

- [Low on ink](#)
- [Carriage stall](#)
- [Need alignment or alignment failed](#)
- [Print cartridges incorrectly installed](#)
- [Non-HP cartridges installed](#)
- [Printing in ink-backup mode](#)
- [Print cartridge is missing, incorrectly installed, or not intended for your product](#)
- [Print cartridges missing or not detected](#)
- [Incompatible print cartridges](#)
- [Print cartridge is not intended for use in this product](#)
- [Print cartridges in wrong slot](#)
- [Print cartridge problem](#)
- [Previously used genuine HP cartridge installed](#)
- [Original HP ink depleted](#)

Low on ink

Solution: Ink level warnings and indicators provide estimates for planning purposes only. When you receive a low-ink warning message, consider having a replacement cartridge available to avoid possible printing delays. You do not need to replace the print cartridges until print quality becomes unacceptable.

If you have installed a refilled or remanufactured cartridge, or a cartridge that has been used in another product, the ink level indicator might be inaccurate or unavailable.

For HP product return and recycling information, visit us at: www.hp.com/recycle.

Cause: The indicated print cartridges were estimated to be low on ink and might need to be replaced soon.

Carriage stall

Try the following solutions to resolve the issue. Solutions are listed in order, with the most likely solution first. If the first solution does not solve the problem, continue trying the remaining solutions until the issue is resolved.

- [Solution 1: Clear the paper jam from the rear door](#)
- [Solution 2: Clear the paper jam from the front](#)
- [Solution 3: Make sure the print carriage can move freely](#)
- [Solution 4: Verify that the product is properly connected to a power source](#)
- [Solution 5: Print a self-test report](#)
- [Solution 6: Reset the product](#)
- [Solution 7: Contact HP support for service](#)

Solution 1: Clear the paper jam from the rear door

Solution: Clear the paper jam from the rear door.

For more information, see:

[“Clear paper jams” on page 131](#)

Cause: The product had a paper jam.

If this did not solve the issue, try the next solution.

Solution 2: Clear the paper jam from the front

Solution: Turn off the product and open the print cartridge door to access the print carriage area. Gently remove any paper that is stuck between the rollers, and then turn on the product again.

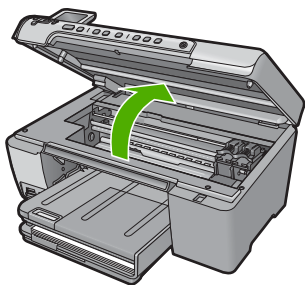

If this did not solve the issue, try the next solution.

Cause: Paper was stuck in the front rollers.

If this did not solve the issue, try the next solution.

Solution 3: Make sure the print carriage can move freely

Solution: Unplug the power cable if it is not already unplugged. Check to see if the print carriage carriage will move freely from one side of the printer to the other. Do not try to force it to move if it is hung up on something.

△ **CAUTION:** Be careful not to force the print carriage carriage. If the carriage is stuck, forcing it to move will damage the printer.

Cause: The print carriage had stalled.

If this did not solve the issue, try the next solution.

Solution 4: Verify that the product is properly connected to a power source

Solution: Verify that the product is properly connected to a suitable power source.

To verify the product is connected to a suitable power source

1. Make sure that you are using the power cord provided with the product.
2. If the product is connected to a computer, make sure the computer has a grounded (three-prong) power plug.
3. Make sure the power cord is firmly connected to both the product and the power adaptor.
4. Plug the power cord directly into a power outlet.

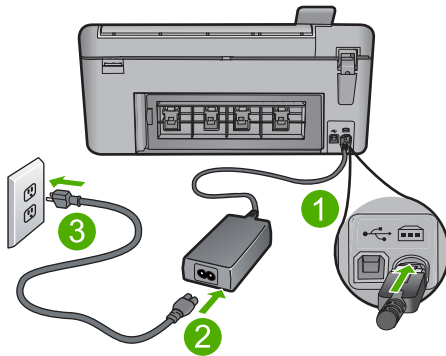

1	Power connection
2	Power cord and adaptor
3	Power outlet

5. Try to print from your computer.
If the product prints when plugged directly into a power outlet while disconnected from any power strips or surge suppressors, the power strip or surge suppressor might not be allowing sufficient voltage to reach the product.
6. If the product cannot print and the print carriage is still stalled, contact HP support for service.
Go to: www.hp.com/support.
If prompted, choose your country/region, and then click **Contact HP** for information on calling for technical support.

Cause: There might not be sufficient voltage for the product.

If this did not solve the issue, try the next solution.

Solution 5: Print a self-test report

Solution: Print a self-test report to see if the product can print.

If the product can print a self-test report and can print from the computer (if applicable), then there is no need to follow the remaining solutions, as the error message might be false.

For more information, see:

[“Print a self-test report” on page 114](#)

Cause: The error was false.

If this did not solve the issue, try the next solution.

Solution 6: Reset the product

Solution: Turn off the product, and then unplug the power cord. Plug the power cord back in, and then press the On button to turn on the product.

To reset the product

1. Remove all paper loaded in the input tray.
2. Make sure that the product is turned on and remove the USB cable from the back of the product.
3. Open the print cartridge door.

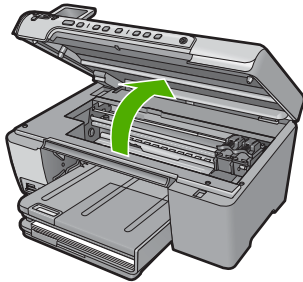

The print carriage should move to the far right side of the product.

4. Remove the print cartridges and keep them aside carefully.
5. Close the print cartridge door.
6. Disconnect the power cord from the product and wait for 60 seconds.
7. Reconnect the power cord to the product.
8. Turn on the product by pressing the On button.
9. Open the print cartridge door.

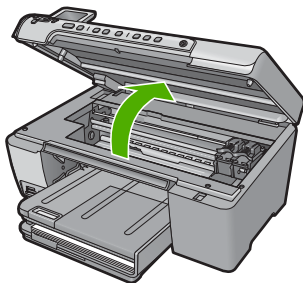

The print carriage should move to the far right side of the product.

10. Reinsert the print cartridges in the appropriate slots.
11. Close the print cartridge door.
12. Load paper in the input tray.
13. If prompted, print a cartridge calibration page, and then scan it.

Cause: The product experienced an error and had to be reset.

If this did not solve the issue, try the next solution.

Solution 7: Contact HP support for service

Solution: If you have completed all of the steps provided in the previous solutions and are still having a problem, contact HP support for service.

Go to: www.hp.com/support.

If prompted, choose your country/region, and then click **Contact HP** for technical support.

Cause: You might need assistance to enable the product or software to function properly.

Need alignment or alignment failed

Try the following solutions to resolve the issue. Solutions are listed in order, with the most likely solution first. If the first solution does not solve the problem, continue trying the remaining solutions until the issue is resolved.

- [Solution 1: Incorrect type of paper is loaded in the input tray](#)
- [Solution 2: Make sure the protective tape is removed from the print cartridges](#)
- [Solution 3: Check if print cartridges are fully inserted](#)
- [Solution 4: Align newly installed print cartridges](#)
- [Solution 5: Print cartridge might be defective](#)

Solution 1: Incorrect type of paper is loaded in the input tray

Solution: If you have colored paper loaded in the input tray when you align the print cartridges, the alignment fails. Load unused plain white letter or A4 paper into the input tray, and then try the alignment again. If the alignment fails again, you might have a defective print cartridge.

To find support and warranty information, go to the HP Web site at www.hp.com/support. If prompted, choose your country/region, and then click **Contact HP** for information on calling for technical support.

Cause: Incorrect type of paper was loaded in the input tray.

If this did not solve the issue, try the next solution.

Solution 2: Make sure the protective tape is removed from the print cartridges

Solution: Check each print cartridge. The tape might have been removed from the copper-colored contacts, but still might cover the ink nozzles. If the tape is still covering the ink nozzles, carefully remove the tape from the print cartridges. Do not touch the ink nozzles or the copper-colored contacts.

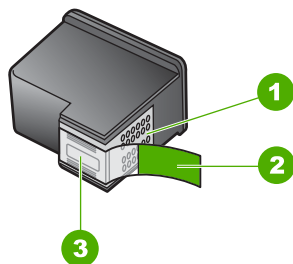

1	Copper-colored contacts
2	Plastic tape with pink pull tab (must be removed before installing)
3	Ink nozzles under tape



Remove and then reinsert the print cartridges. Verify that they are fully inserted and locked in place.

Cause: Protective tape was covering the print cartridges.

If this did not solve the issue, try the next solution.

Solution 3: Check if print cartridges are fully inserted

Solution: Remove and then reinsert the print cartridges. Verify that they are fully inserted and locked in place.

Cause: The contacts on the print cartridge were not touching the contacts in the print carriage.

If this did not solve the issue, try the next solution.

Solution 4: Align newly installed print cartridges

Solution: You must align the print cartridges to ensure excellent print quality.

If the alignment error persists and you cannot clear it, your print cartridge might be defective. Check to see if your print cartridge is still under warranty and end of warranty date has not been reached.

- If the end of warranty date has been reached, purchase a new print cartridge.
- If the end of warranty date has not been reached, contact HP support. Go to www.hp.com/support. If prompted, choose your country/region, and then click **Contact HP** for information on calling for technical support.

For more information, see:

- [“Align the print cartridges” on page 106](#)
- [“Print cartridge warranty information” on page 269](#)
- [“Shop for ink supplies” on page 117](#)

Cause: You installed new print cartridges that needed alignment.

If this did not solve the issue, try the next solution.

Solution 5: Print cartridge might be defective

Solution: Contact HP support for service.

Go to: www.hp.com/support.

If prompted, choose your country/region, and then click **Contact HP** for information on calling for technical support.

Cause: The print cartridge was defective.

Print cartridges incorrectly installed

Solution: Remove and reinsert the print cartridges and verify that they are fully inserted and locked in place.

Also, make sure the print cartridges are installed into the correct slots.

To make sure the print cartridges are installed correctly

1. Make sure the product is turned on.

△ **CAUTION:** If the product is turned off when you open the print cartridge door to access the print cartridges, it will not release the cartridges for changing. You might damage the product if the print cartridges are not docked safely when you try to remove them.

2. Open the print cartridge door.
The print carriage moves to the far right side of the product.

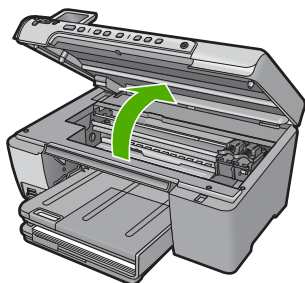

3. Check to make sure you are using the correct print cartridges for your product. For a list of compatible print cartridges, see the printed documentation that came with the product.

4. Remove the black print cartridge from the slot on the right. Do not touch the ink nozzles or the copper-colored contacts. Check for possible damage to the copper-colored contacts or ink nozzles.

Make sure the clear plastic tape has been removed. If it is still covering the ink nozzles, gently remove the clear plastic tape by using the pink pull tab. Make sure you do not remove the copper colored tape containing the electrical contacts.

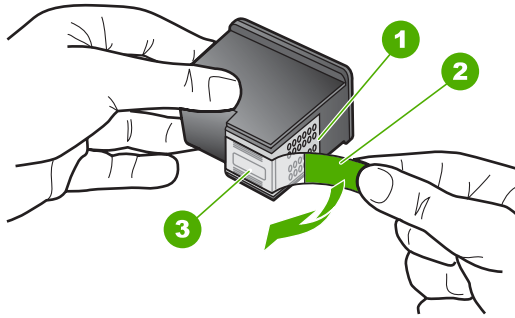

1	Copper-colored contacts
2	Plastic tape with pink pull tab (must be removed before installing)
3	Ink nozzles under tape

5. Reinsert the print cartridge by sliding it forward into the slot on the right. Then push the print cartridge forward until it clicks into the socket.

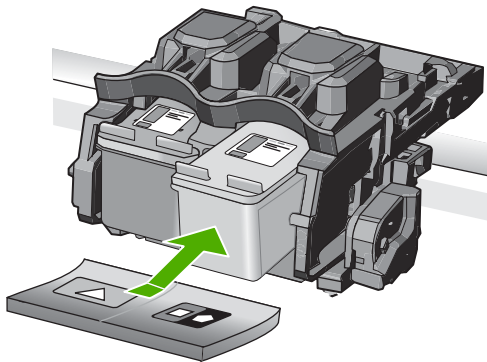

6. Repeat steps 1 and 2 for the tri-color print cartridge on the left side.

Cause: The indicated print cartridges were installed incorrectly.

Non-HP cartridges installed

Solution: Follow the prompts on the display to continue, or replace the indicated print cartridges with genuine HP cartridges.

HP recommends that you use genuine HP print cartridges. Genuine HP print cartridges are designed and tested with HP printers to help you easily produce great results, time after time.

 **NOTE:** HP cannot guarantee the quality or reliability of non-HP supplies. Printer service or repairs required as a result of using of a non-HP supply will not be covered under warranty.

If you believe you purchased genuine HP print cartridges, go to:

www.hp.com/go/anticounterfeit

For more information, see:

[“Replace the print cartridges” on page 99](#)

Cause: The product detected that a non-HP print cartridge was installed.

Printing in ink-backup mode

Solution: If you receive the ink-backup mode message and two print cartridges are installed in the product, verify that the protective piece of plastic tape has been removed from each print cartridge. When plastic tape covers the print cartridge contacts, the product cannot detect that the print cartridge is installed.

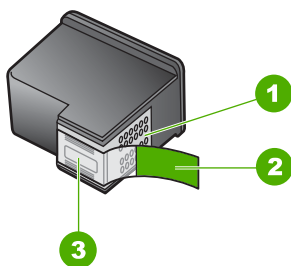

1	Copper-colored contacts
2	Plastic tape with pink pull tab (must be removed before installing)
3	Ink nozzles under tape

Cause: When the product detected that only one print cartridge is installed, ink-backup mode is initiated. This printing mode lets you print with a single print cartridge, but it slows the product and affects the quality of printouts.

Print cartridge is missing, incorrectly installed, or not intended for your product

Try the following solutions to resolve the issue. Solutions are listed in order, with the most likely solution first. If the first solution does not solve the problem, continue trying the remaining solutions until the issue is resolved.

- [Solution 1: Insert the print cartridges](#)
- [Solution 2: Remove the tape from the print cartridges](#)

- [Solution 3: Remove and reinsert the print cartridges](#)
- [Solution 4: Contact HP support](#)

Solution 1: Insert the print cartridges

Solution: One or both of the print cartridges is missing. Remove and reinsert the print cartridges and verify that they are fully inserted and locked in place. If the problem persists, clean the contacts of the print cartridges.

For more information, see:

[“Clean the print cartridge contacts” on page 108](#)

Cause: The print cartridge was missing.

If this did not solve the issue, try the next solution.

Solution 2: Remove the tape from the print cartridges

Solution: Check each print cartridge. The tape might have been removed from the copper-colored contacts, but still might cover the ink nozzles. If the tape is still covering the ink nozzles, carefully remove the tape from the print cartridges. Do not touch the ink nozzles or the copper-colored contacts.

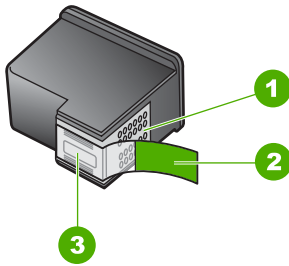

1	Copper-colored contacts
2	Plastic tape with pink pull tab (must be removed before installing)
3	Ink nozzles under tape



Cause: Protective tape was covering the print cartridges.

If this did not solve the issue, try the next solution.

Solution 3: Remove and reinsert the print cartridges

Solution: One or both of the print cartridges are not installed or are installed incorrectly. Remove and reinsert the print cartridges and verify that they are fully inserted and locked in place. If the problem persists, clean the copper-colored contacts of the print cartridges.

For more information, see:

[“Clean the print cartridges” on page 107](#)

Cause: One or both of the print cartridges were not installed or were installed incorrectly.

If this did not solve the issue, try the next solution.

Solution 4: Contact HP support

Solution: Contact HP support for service.

Go to: www.hp.com/support.

If prompted, choose your country/region, and then click **Contact HP** for information on calling for technical support.

Cause: The print cartridge was defective or not intended for use in this product.

Print cartridges missing or not detected

Try the following solutions to resolve the issue. Solutions are listed in order, with the most likely solution first. If the first solution does not solve the problem, continue trying the remaining solutions until the issue is resolved.

- [Solution 1: Reinsert the print cartridges](#)
- [Solution 2: Clean the print cartridge contacts](#)
- [Solution 3: Replace the print cartridge](#)

Solution 1: Reinsert the print cartridges

Solution: Remove and reinsert the print cartridges and verify that they are fully inserted and locked in place.

Also, make sure the print cartridges are installed into the correct slots.

To make sure the print cartridges are installed correctly

1. Make sure the product is turned on.

△ **CAUTION:** If the product is turned off when you open the print cartridge door to access the print cartridges, it will not release the cartridges for changing. You might damage the product if the print cartridges are not docked safely when you try to remove them.

2. Open the print cartridge door.
The print carriage moves to the far right side of the product.

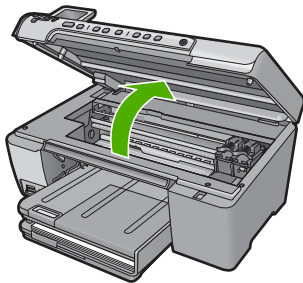

3. Check to make sure you are using the correct print cartridges for your product.
For a list of compatible print cartridges, see the printed documentation that came with the product.

- Remove the black print cartridge from the slot on the right. Do not touch the ink nozzles or the copper-colored contacts. Check for possible damage to the copper-colored contacts or ink nozzles.

Make sure the clear plastic tape has been removed. If it is still covering the ink nozzles, gently remove the clear plastic tape by using the pink pull tab. Make sure you do not remove the copper colored tape containing the electrical contacts.

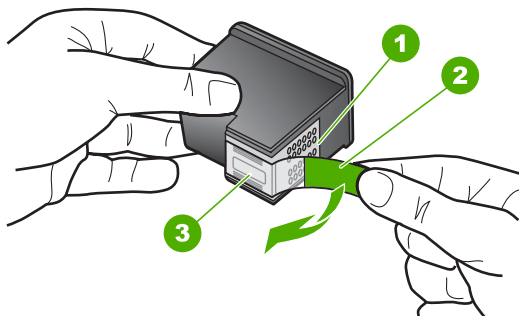

1	Copper-colored contacts
2	Plastic tape with pink pull tab (must be removed before installing)
3	Ink nozzles under tape

- Reinsert the print cartridge by sliding it forward into the slot on the right. Then push the print cartridge forward until it clicks into the socket.

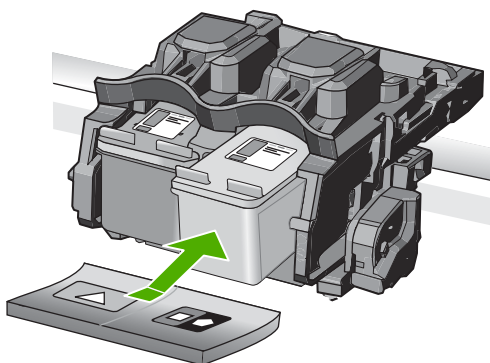

- Repeat steps 1 and 2 for the tri-color print cartridge on the left side.

Cause: The indicated print cartridges were installed incorrectly.

If this did not solve the issue, try the next solution.

Solution 2: Clean the print cartridge contacts

Solution: Clean the print cartridge contacts.

Make sure you have the following materials available:

- Dry foam rubber swabs, lint-free cloth, or any soft material that will not come apart or leave fibers.

 **TIP:** Coffee filters are lint-free and work well for cleaning print cartridges.

- Distilled, filtered, or bottled water (tap water might contain contaminants that can damage the print cartridges).

 **CAUTION:** Do **not** use platen cleaners or alcohol to clean the print cartridge contacts. These can damage the print cartridge or the product.

For more information, see:

[“Clean the print cartridge contacts” on page 108](#)

Cause: The print cartridge contacts needed to be cleaned.

If this did not solve the issue, try the next solution.

Solution 3: Replace the print cartridge

Solution: Replace the indicated print cartridge. You can also remove the indicated print cartridge and print using ink-backup mode.

 **NOTE:** During ink-backup mode, the product can only print jobs from the computer. You cannot initiate a print job from the control panel (such as printing a photo from a memory card).

Check to see if your print cartridge is still under warranty and end of warranty date has not been reached.

- If the end of warranty date has been reached, purchase a new print cartridge.
- If the end of warranty date has not been reached, contact HP support. Go to www.hp.com/support. If prompted, choose your country/region, and then click **Contact HP** for information on calling for technical support.

For more information, see:

[“Print cartridge warranty information” on page 269](#)

Cause: The print cartridge was damaged.

Incompatible print cartridges

Try the following solutions to resolve the issue. Solutions are listed in order, with the most likely solution first. If the first solution does not solve the problem, continue trying the remaining solutions until the issue is resolved.

- [Solution 1: Check the print cartridge](#)
- [Solution 2: Contact HP support for service](#)

Solution 1: Check the print cartridge

Solution: Check to make sure you are using the correct print cartridges for your product. For a list of compatible print cartridges, see the printed documentation that came with the product.

If you are using print cartridges that are not compatible with the product, replace the indicated print cartridges with print cartridges that are compatible.

If it appears that you are using the correct print cartridges, proceed to the next solution.

For more information, see:

[“Replace the print cartridges” on page 99](#)

Cause: The indicated print cartridges were not compatible with the product.

If this did not solve the issue, try the next solution.

Solution 2: Contact HP support for service

Solution: If you have completed all of the steps provided in the previous solutions and are still having a problem, contact HP support for service.

Go to: www.hp.com/support.

If prompted, choose your country/region, and then click **Contact HP** for technical support.

Cause: The print cartridges were not intended for use in this product.

Print cartridge is not intended for use in this product

Solution: Contact HP support for service.

Go to: www.hp.com/support.

If prompted, choose your country/region, and then click **Contact HP** for information on calling for technical support.

Cause: The print cartridge was not intended for use in this product.

Print cartridges in wrong slot

Solution: Remove and reinsert the print cartridges and verify that they are fully inserted and locked in place.

Also, make sure the print cartridges are installed into the correct slots.

To make sure the print cartridges are installed correctly

1. Make sure the product is turned on.

△ **CAUTION:** If the product is turned off when you open the print cartridge door to access the print cartridges, it will not release the cartridges for changing. You might damage the product if the print cartridges are not docked safely when you try to remove them.

2. Open the print cartridge door.
The print carriage moves to the far right side of the product.

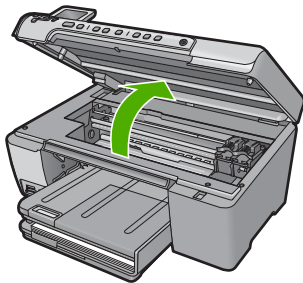

3. Check to make sure you are using the correct print cartridges for your product.
For a list of compatible print cartridges, see the printed documentation that came with the product.

- Remove the black print cartridge from the slot on the right. Do not touch the ink nozzles or the copper-colored contacts. Check for possible damage to the copper-colored contacts or ink nozzles.
Make sure the clear plastic tape has been removed. If it is still covering the ink nozzles, gently remove the clear plastic tape by using the pink pull tab. Make sure you do not remove the copper colored tape containing the electrical contacts.

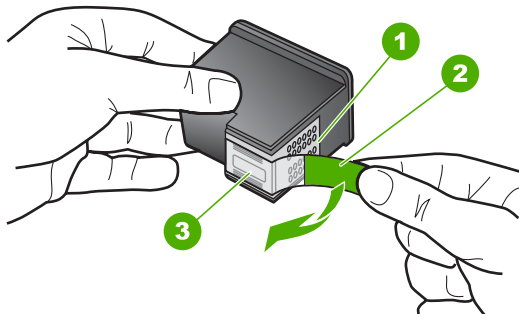

1	Copper-colored contacts
2	Plastic tape with pink pull tab (must be removed before installing)
3	Ink nozzles under tape

- Reinsert the print cartridge by sliding it forward into the slot on the right. Then push the print cartridge forward until it clicks into the socket.

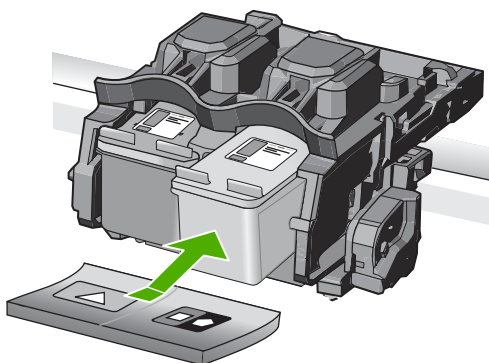

- Repeat steps 1 and 2 for the tri-color print cartridge on the left side.

NOTE: If the print cartridges are installed in the wrong slots and you cannot remove them from the product, contact HP support for service.

Go to: www.hp.com/support.

If prompted, choose your country/region, and then click **Contact HP** for information on calling for technical support.

Cause: The indicated print cartridges were installed incorrectly.

Print cartridge problem

The message might indicate which cartridge is causing the problem. If so, try the following solutions to resolve the issue. Solutions are listed in order, with the most likely solution first. If the first solution does not solve the problem, continue trying the remaining solutions until the issue is resolved.

If the message does not indicate which cartridge is causing the problem, follow these steps to determine which cartridge is the problem cartridge. After you determine which cartridge is the problem cartridge, continue with the first solution.

To determine which print cartridge is having the problem

1. Make sure the product is on.

△ **CAUTION:** If the product is turned off when you open the print cartridge door to access the print cartridges, it will not release the cartridges for changing. You might damage the product if the print cartridges are not docked safely when you try to remove them.

2. Open the print cartridge door.
The print carriage moves to the far right side of the product.

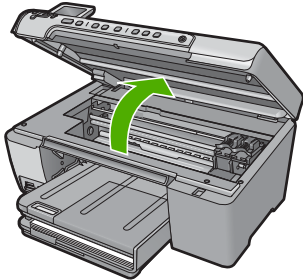

3. Check to make sure you are using the correct print cartridges for your product. For a list of compatible print cartridges, see the printed documentation that came with the product.

4. Remove the black print cartridge from the slot on the right. Press down on the cartridge to release it, and then pull it toward you out of the slot.

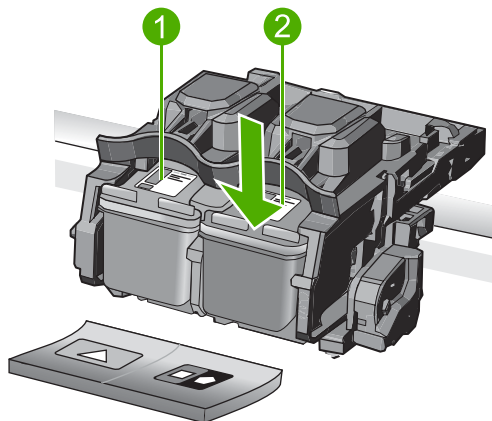

1	Tri-color print cartridge
2	Black print cartridge

5. Close the print cartridge door.
6. Check to see if the error has been resolved.
 - If the error has been resolved, then there is a problem with the black print cartridge.
 - If the error has not been resolved, continue to the next step.
7. Open the print cartridge door and reinsert the black print cartridge by sliding it forward into the slot on the right. Then push the print cartridge forward until it clicks into the slot.

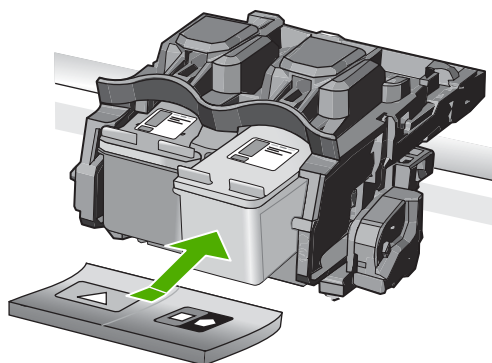

8. Remove the tri-color print cartridge from the slot on the left. Press down on the cartridge to release it, and then pull it toward you out of the slot.
9. Close the print cartridge door.

10. Check to see if the error has been resolved.
 - If the error has been resolved, then there is a problem with the tri-color print cartridge.
 - If the error has not been resolved, then there is a problem with both print cartridges.
11. Open the print cartridge door and reinsert the tri-color print cartridge by sliding it forward into the slot on the left. Then push the print cartridge forward until it clicks into the slot.
12. Close the print cartridge door.
 - [Solution 1: Remove and reinsert the print cartridges](#)
 - [Solution 2: Clean the print cartridge contacts](#)
 - [Solution 3: Replace the print cartridge](#)

Solution 1: Remove and reinsert the print cartridges

Solution: Remove and reinsert the print cartridges and verify that they are fully inserted and locked in place.

Also, make sure the print cartridges are installed into the correct slots.

To make sure the print cartridges are installed correctly

1. Make sure the product is turned on.

△ **CAUTION:** If the product is turned off when you open the print cartridge door to access the print cartridges, it will not release the cartridges for changing. You might damage the product if the print cartridges are not docked safely when you try to remove them.

2. Open the print cartridge door.
The print carriage moves to the far right side of the product.

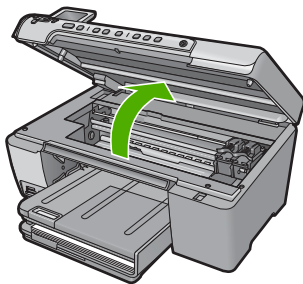

3. Check to make sure you are using the correct print cartridges for your product.
For a list of compatible print cartridges, see the printed documentation that came with the product.

- Remove the black print cartridge from the slot on the right. Do not touch the ink nozzles or the copper-colored contacts. Check for possible damage to the copper-colored contacts or ink nozzles.

Make sure the clear plastic tape has been removed. If it is still covering the ink nozzles, gently remove the clear plastic tape by using the pink pull tab. Make sure you do not remove the copper colored tape containing the electrical contacts.

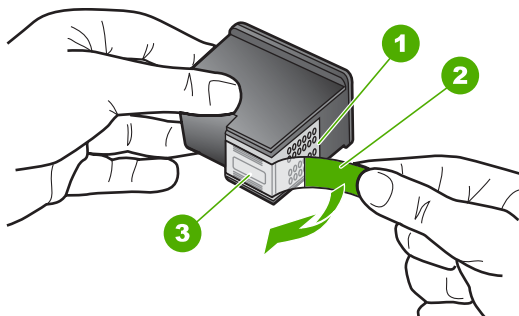

1	Copper-colored contacts
2	Plastic tape with pink pull tab (must be removed before installing)
3	Ink nozzles under tape

- Reinsert the print cartridge by sliding it forward into the slot on the right. Then push the print cartridge forward until it clicks into the socket.

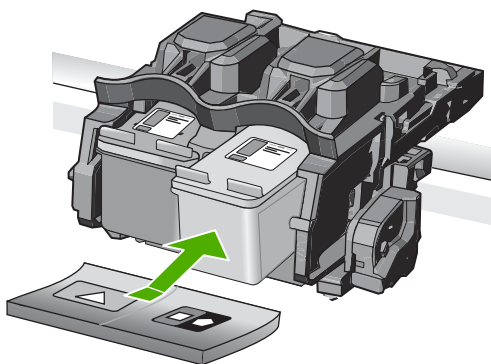

- Repeat steps 1 and 2 for the tri-color print cartridge on the left side.

Cause: The indicated print cartridges were installed incorrectly.
If this did not solve the issue, try the next solution.

Solution 2: Clean the print cartridge contacts

Solution: Clean the print cartridge contacts on the print cartridges that are experiencing the problem.

Make sure you have the following materials available:

- Dry foam rubber swabs, lint-free cloth, or any soft material that will not come apart or leave fibers.

 **TIP:** Coffee filters are lint-free and work well for cleaning print cartridges.

- Distilled, filtered, or bottled water (tap water might contain contaminants that can damage the print cartridges).

 **CAUTION:** Do **not** use platen cleaners or alcohol to clean the print cartridge contacts. These can damage the print cartridge or the product.

For more information, see:

[“Clean the print cartridge contacts” on page 108](#)

Cause: The print cartridge contacts needed to be cleaned.

If this did not solve the issue, try the next solution.

Solution 3: Replace the print cartridge

Solution: Replace the print cartridges that are experiencing the problem. If only one of the print cartridges is experiencing the problem, you can also remove it and print using ink-backup mode.

 **NOTE:** During ink-backup mode, the product can only print jobs from the computer. You cannot initiate a print job from the control panel (such as printing a photo from a memory card).

Cause: One or both of the print cartridges were having a problem.

Previously used genuine HP cartridge installed

Solution: Check the print quality of the current print job. If it is satisfactory, follow the prompts on the display to continue.

HP recommends that you have an new print cartridge available, to avoid printing delays.

 **NOTE:** Ink levels might not be available for the indicated print cartridges.

Cause: The genuine HP ink cartridge was previously used in some other product.

Original HP ink depleted

Solution: Follow the prompts on the display to continue, or replace the indicated print cartridges with genuine HP cartridges.

HP recommends that you use genuine HP print cartridges. Genuine HP print cartridges are designed and tested with HP printers to help you easily produce great results, time after time.

 **NOTE:** HP cannot guarantee the quality or reliability of non-HP supplies. Printer service or repairs required as a result of using of a non-HP supply will not be covered under warranty.

If you believe you purchased genuine HP print cartridges, go to:

www.hp.com/go/anticounterfeit

For more information, see:

[“Replace the print cartridges” on page 99](#)

Cause: The original HP ink in the indicated print cartridges had been depleted.

15 HP warranty and support

Hewlett-Packard provides Internet and phone support for the HP All-in-One.

This section contains the following topics:

- [Warranty](#)
- [Print cartridge warranty information](#)
- [Support process](#)
- [Before you call HP support](#)
- [HP support by phone](#)
- [Additional warranty options](#)
- [HP Quick Exchange Service \(Japan\)](#)
- [HP Korea customer support](#)
- [Prepare the HP All-in-One for shipment](#)
- [Pack the HP All-in-One](#)

Warranty

For more information about the warranty, see the printed documentation that came with the product.

Print cartridge warranty information

The HP cartridge warranty is applicable when the product is used in its designated HP printing device. This warranty does not cover HP ink products that have been refilled, remanufactured, refurbished, misused, or tampered with.

During the warranty period the product is covered as long as the HP ink is not depleted and the end of warranty date has not been reached. The end of warranty date, in YYYY/MM/DD format, may be found on the product as indicated:

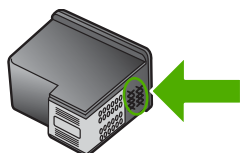

For a copy of the HP Limited Warranty Statement, see the printed documentation that came with the product.

Support process

If you have a problem, follow these steps:

1. Check the documentation that came with the product.
2. Visit the HP online support Web site at www.hp.com/support. HP online support is available to all HP customers. It is the fastest source for up-to-date product information and expert assistance and includes the following features:
 - Fast access to qualified online support specialists
 - Software and driver updates for the product

- Valuable product and troubleshooting information for common problems
 - Proactive product updates, support alerts, and HP newsgroups that are available when you register the product
3. Call HP support. Support options and availability vary by product, country/region, and language.

Before you call HP support

Software programs from other companies might be included with the HP All-in-One. If you experience problems with any of those programs, you will receive the best technical assistance by calling the experts at that company.

If you need to contact HP support, do the following before you call:

1. Make sure that:
 - a. The product is plugged in and turned on.
 - b. The specified print cartridges are installed correctly.
 - c. The recommended paper is properly loaded in the input tray.
2. Reset the product:
 - a. Turn off the product by pressing the On button.
 - b. Unplug the power cord from the back of the product.
 - c. Plug the power cord back into the product.
 - d. Turn on the product by pressing the On button.
3. To find support and warranty information, go to the HP Web site at www.hp.com/support. If prompted, choose your country/region, and then click **Contact HP** for information on calling for technical support.
Check the HP Web site for updated information or troubleshooting tips for the product.
4. If you are still experiencing problems and need to speak with an HP support representative, do the following:
 - a. Have the specific name of the product, as it appears on the control panel, available.
 - b. Print a self-test report.
 - c. Make a color copy to have available as a sample printout.
 - d. Be prepared to describe your problem in detail.
 - e. Have your serial number ready.
You can view the serial number by looking at the sticker on the rear side of the product. The serial number is the 10-character code in the upper left corner of the sticker.



NOTE: The device serial number can also be accessed using the HP Photosmart software. To access the device serial number from the software, on the Windows taskbar, click **Start > All Programs > HP > HP Solution Center**. On the **Help** page, click **Technical information** under **Tools**.

5. Call HP support. Be near the product when you call.

Related topics

["Print a self-test report" on page 114](#)

HP support by phone

For a list of support phone numbers, see the printed documentation that came with the device. This section contains the following topics:

- [Phone support period](#)
- [Placing a call](#)
- [After the phone support period](#)

Phone support period

One year of phone support is available in North America, Asia Pacific, and Latin America (including Mexico). To determine the duration of phone support in Europe, the Middle East, and Africa, go to www.hp.com/support. Standard phone company charges apply.

Placing a call

Call HP support while you are in front of the computer and the product. Be prepared to provide the following information:

- Model number (located on the label on the front of the product)
- Serial number (located on the back or bottom of the product)
- Messages that appear when the situation occurs
- Answers to these questions:
 - Has this situation happened before?
 - Can you re-create it?
 - Did you add any new hardware or software to your computer at about the time that this situation began?
 - Did anything else occur prior to this situation (such as a thunderstorm, product was moved, etc.)?

After the phone support period

After the phone support period, help is available from HP at an additional cost. Help may also be available at the HP online support Web site: www.hp.com/support. Contact your HP dealer or call the support phone number for your country/region to learn more about support options.

Additional warranty options

Extended service plans are available for the HP All-in-One at additional costs. Go to www.hp.com/support, select your country/region and language, then explore the services and warranty area for information about the extended service plans.

HP Quick Exchange Service (Japan)

プリント カートリッジに問題がある場合は以下に記載されている電話番号に連絡してください。プリント カートリッジが故障している、または欠陥があると判断された場合、HP Quick Exchange Service がこのプリント カートリッジを正常品と交換し、故障したプリント カートリッジを回収します。保障期間中は、修理代と送料は無料です。また、お住まいの地域にもよりますが、プリンタを次の日までに交換することも可能です。

電話番号： 0570-000511 (自動応答)
03-3335-9800 (自動応答システムが使用できない場合)

サポート時間： 平日の午前 9:00 から午後 5:00 まで
土日の午前 10:00 から午後 5:00 まで
祝祭日および 1 月 1 日から 3 日は除きます。

サービスの条件:

- サポートの提供は、カスタマケアセンターを通してのみ行われます。
- カスタマケアセンターがプリンタの不具合と判断した場合に、サービスを受けることができます。

ご注意：ユーザの扱いが不適切であったために故障した場合は、保障期間中であっても修理は有料となります。詳細については保証書を参照してください。

その他の制限:

- 運搬の時間はお住まいの地域によって異なります。詳しくは、カスタマケアセンターに連絡してご確認ください。
- 出荷配送は、当社指定の配送業者が行います。
- 配送は交通事情などの諸事情によって、遅れる場合があります。
- このサービスは、将来予告なしに変更することがあります。

For instructions on how to pack your product for exchange, see [“Pack the HP All-in-One”](#) on page 274.

HP Korea customer support

HP 한국 고객 지원 문의

- 고객 지원 센터 대표 전화
1588-3003
- 제품가격 및 구입처 정보 문의 전화
080-703-0700
- 전화 상담 가능 시간:
평 일 09:00~18:00
토요일 09:00~13:00
(일요일, 공휴일 제외)

Prepare the HP All-in-One for shipment

If, after contacting HP support or returning to the point of purchase, you are requested to send the HP All-in-One in for service, make sure you remove and keep the following items before returning your device:

- The print cartridges
- The control panel faceplate
- The power cord, USB cable, and any other cable connected to the HP All-in-One

△ CAUTION: The replacement HP All-in-One will not be shipped with a power cord. Store the power cord in a safe place until the replacement HP All-in-One arrives.

- Any paper loaded in the input tray
- Remove any originals you might have loaded in the HP All-in-One

This section contains the following topics:

- [Remove the print cartridges before shipment](#)
- [Remove the control panel faceplate](#)

Remove the print cartridges before shipment

Before you return the HP All-in-One, make sure you remove your print cartridges.

 **NOTE:** This information does not apply to customers in Japan. For information on service options in Japan, see "[HP Quick Exchange Service \(Japan\)](#)" on page 272.

To remove print cartridges before shipment

1. Turn on the HP All-in-One and wait until the print carriage is idle and silent. If the HP All-in-One will not turn on, skip this step and go to step 2.
2. Open the print cartridge door.
3. Remove the print cartridges from their slots.

 **NOTE:** If the HP All-in-One does not turn on, you can unplug the power cord and then manually slide the print carriage to the far right side to remove the print cartridges.

4. Place the print cartridges in an airtight plastic container so they will not dry out, and put them aside. Do not send them with the HP All-in-One unless the HP customer support call agent instructs you to.
5. Close the print cartridge door and wait a few minutes for the print carriage to move back to its home position (on the left side).

 **NOTE:** Make sure the scanner is idle and has returned to its parked position before turning off the HP All-in-One.

6. Press the On button to turn off the HP All-in-One.

Remove the control panel faceplate

Remove the control panel faceplate before returning the HP All-in-One for repair.

 **NOTE:** This information does not apply to customers in Japan. For information on service options in Japan, see "[HP Quick Exchange Service \(Japan\)](#)" on page 272.

△ CAUTION: The HP All-in-One must be unplugged before following these steps.

To remove the control panel faceplate

1. Press the On button to turn off the HP All-in-One.
2. Unplug the power cord, and then disconnect it from the HP All-in-One. Do not return the power cord with the HP All-in-One.
3. Remove the control panel faceplate as follows:
 - a. Place your hands on each side of the control panel faceplate.
 - b. Place the fingertips of your left hand in the small gap under the display, and then pry the faceplate down and to the right.

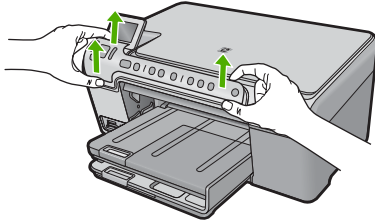

4. Retain the control panel faceplate. Do not return the control panel faceplate with the HP All-in-One.

CAUTION: The replacement HP All-in-One might not come with a control panel faceplate. Store your control panel faceplate in a safe place, and when the replacement HP All-in-One arrives, reattach your control panel faceplate. You must attach your control panel faceplate to use the control panel functions on the replacement HP All-in-One.

NOTE: See the Start Here guide that came with the HP All-in-One for instructions on how to attach your control panel faceplate. The replacement HP All-in-One might come with instructions for setting up your device.

Pack the HP All-in-One

Complete the following steps once you have removed the print cartridges, removed the control panel faceplate, turned off the HP All-in-One, and unplugged it.

To pack the HP All-in-One

1. If available, pack the HP All-in-One for shipment by using the original packing materials or the packaging materials that came with your exchange device.

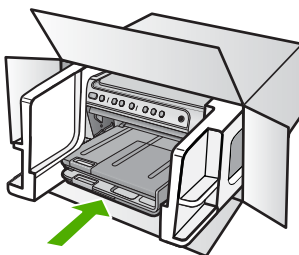

If you do not have the original packaging materials, please use other adequate packaging materials. Shipping damage caused by improper packaging and/or improper transportation is not covered under the warranty.

2. Place the return shipping label on the outside of the box.
3. Include the following items in the box:
 - A complete description of symptoms for service personnel (samples of print quality problems are helpful).
 - A copy of the sales slip or other proof of purchase to establish the warranty coverage period.
 - Your name, address, and a phone number where you can be reached during the day.

16 Technical information

The technical specifications and international regulatory information for the HP All-in-One are provided in this section.

For additional specifications, see the printed documentation that came with the HP All-in-One.

This section contains the following topics:

- [Specifications](#)
- [Environmental product stewardship program](#)
- [Regulatory notices](#)

Specifications

Technical specifications for the HP All-in-One are provided in this section. For additional specifications, see the printed documentation that came with the HP All-in-One.

System requirements

Software and system requirements are located in the Readme file.

For information about future operating system releases and support, visit the HP online support Web site at www.hp.com/support.

Paper specifications

Type	Paper weight	Input tray*	Output tray†	Photo tray*
Plain paper	20 to 24 lb. (75 to 90 gsm)	Up to 125 (20 lb. paper)	50 (20 lb. paper)	n/a
Legal paper	20 to 24 lb. (75 to 90 gsm)	Up to 100 (20 lb. paper)	50 (20 lb. paper)	n/a
Cards	110 lb. index max (200 gsm)	Up to 20	25	Up to 20
Envelopes	20 to 24 lb. (75 to 90 gsm)	Up to 15	15	n/a
Transparency film	n/a	Up to 40	25	n/a
Labels	n/a	Up to 40	25	n/a
5 x 7 inch (13 x 18 cm) Photo paper	145 lb. (236 gsm)	Up to 20	20	Up to 20
4 x 6 inch (10 x 15 cm) Photo paper	145 lb. (236 gsm)	Up to 20	20	Up to 20
8.5 x 11 inch (216 x 279 mm) Photo paper	n/a	Up to 40	25	n/a

* Maximum capacity.

† Output tray capacity is affected by the type of paper and the amount of ink you are using. HP recommends emptying the output tray frequently.

*

 **NOTE:** For a complete list of supported media sizes, see the printer driver.

Print specifications

- Print speeds vary according to the complexity of the document
- Panorama-size printing
- Method: drop-on-demand thermal inkjet
- Language: PCL3 GUI

Copy specifications

- Copy resolution up to 4800x1200 optimized dpi output using a scan resolution of 1200x1200ppi
- Digital image processing
- Up to 50 copies from original (varies by model)
- Zoom to 400%, fit to page
- Copy speeds vary according to the complexity of the document

Scan specifications

- Image editor included
- Integrated OCR software automatically converts scanned text to editable text (if installed)
- Twain-compliant interface
- Resolution: up to 1200 x 2400 dpi optical (varies by model); 19200 dpi enhanced (software)
- Color: 48-bit color, 8-bit grayscale (256 levels of gray)
- Maximum scan size from glass: 21.6 x 29.7 cm (8.5 x 11.7 inches)

Print resolution

To find out about the printer resolution, see the printer software. For more information, see [“View the print resolution” on page 53](#).

Print cartridge yield

Visit www.hp.com/pageyield for more information on estimated cartridge yields.

Acoustic information

If you have Internet access, you can get acoustic information from the HP Web site. Go to: www.hp.com/support.

Environmental product stewardship program

Hewlett-Packard is committed to providing quality products in an environmentally sound manner. Design for recycling has been incorporated into this product. The number of materials has been kept to a minimum while ensuring proper functionality and reliability. Dissimilar materials have been designed to separate easily. Fasteners and other connections are easy to locate, access, and remove using common tools. High priority parts have been designed to access quickly for efficient disassembly and repair.

For more information, visit HP's Commitment to the Environment Web site at:

www.hp.com/hpinfo/globalcitizenship/environment/index.html

This section contains the following topics:

- [Paper use](#)
- [Plastics](#)
- [Material safety data sheets](#)
- [Recycling program](#)
- [HP inkjet supplies recycling program](#)
- [Energy Star® notice](#)
- [Disposal of waste equipment by users in private households in the European Union](#)

Paper use

This product is suited for the use of recycled paper according to DIN 19309 and EN 12281:2002.

Plastics

Plastic parts over 25 grams are marked according to international standards that enhance the ability to identify plastics for recycling purposes at the end of product life.

Material safety data sheets

Material safety data sheets (MSDS) can be obtained from the HP Web site at:

www.hp.com/go/msds

Recycling program

HP offers an increasing number of product return and recycling programs in many countries/regions, and partners with some of the largest electronic recycling centers throughout the world. HP conserves resources by reselling some of its most popular products. For more information regarding recycling of HP products, please visit:

www.hp.com/hpinfo/globalcitizenship/environment/recycle/

HP inkjet supplies recycling program

HP is committed to protecting the environment. The HP Inkjet Supplies Recycling Program is available in many countries/regions, and lets you recycle used print cartridges and ink cartridges free of charge. For more information, go to the following Web site:

www.hp.com/hpinfo/globalcitizenship/environment/recycle/

Energy Star® notice

This product is designed to reduce power consumption and save natural resources without compromising product performance. It has been designed to reduce total energy consumption both during operation and when the product is not active. This product qualifies for ENERGY STAR® which is a voluntary program established to encourage the development of energy-efficient office products.



ENERGY STAR is a U.S. registered service mark of the U.S. EPA. As an ENERGY STAR partner, HP has determined that this product meets ENERGY STAR guidelines for energy efficiency.

For more information on ENERGY STAR guidelines, go to the following Web site:

www.energystar.gov

Disposal of waste equipment by users in private households in the European Union



Technical information

Disposal of Waste Equipment by Users in Private Households in the European Union
 This symbol on the product or on its packaging indicates that this product must not be disposed of with your other household waste. Instead, it is your responsibility to dispose of your waste equipment by handing it over to a designated collection point for the recycling of waste electrical and electronic equipment. The separate collection and recycling of your waste equipment to the limit of disposal will help to conserve natural resources and ensure that it is recycled in a manner that protects human health and the environment. For more information about where you can drop off your waste equipment for recycling, please contact your local city office, your household waste disposal service or the shop where you purchased the product.

Evacuación de los equipos usados por los usuarios en los hogares privados en la Unión Europea
 La presencia de este símbolo en el producto o en su embalaje indica que este producto no puede ser desechado con los residuos domésticos. En su lugar, es su responsabilidad eliminarlo de su hogar de una manera que proteja la salud humana y el medio ambiente. Para más información acerca de dónde y cómo puede dejar estos residuos para su reciclado, póngase en contacto con las autoridades locales de su ciudad, con el servicio de gestión de residuos domésticos o con la tienda donde adquirió el producto.

Entsorgung von Elektrogeräten durch Benutzer in privaten Haushalten in der EU
 Dieses Symbol auf dem Produkt oder dessen Verpackung gibt an, dass das Produkt nicht zusammen mit dem Restmüll entsorgt werden darf. Es obliegt daher Ihrer Verantwortung, das Gerät an einer entsprechenden Stelle für die Entsorgung oder Wiederverwertung von Elektrogeräten aller Art abzugeben (z.B. einen Wertstoffhof). Die separate Sammlung und das Recycling Ihrer alten Elektrogeräte zum Zeitpunkt Ihrer Entsorgung tragen zum Schutz der Umwelt bei und gewährleisten, dass sie auf eine Art und Weise recycelt werden, die keine Gefährdung für die Gesundheit des Menschen und der Umwelt darstellt. Weitere Informationen darüber, wo Sie alte Elektrogeräte zum Recyceln abgeben können, erhalten Sie bei den örtlichen Behörden, Wertstoffhöfen oder dort, wo Sie das Gerät erworben haben.

Smaltimento di apparecchiature da rottamare da parte di privati nell'Unione Europea
 Questo simbolo che appare sul prodotto o sulla confezione indica che il prodotto non deve essere smaltito assieme agli altri rifiuti domestici. Gli utenti devono provvedere allo smaltimento delle apparecchiature da rottamare portandole al luogo di raccolta indicato per il riciclaggio delle apparecchiature elettriche ed elettroniche. La raccolta e il riciclaggio separati delle apparecchiature da rottamare in fase di smaltimento favoriscono la conservazione delle risorse naturali e garantiscono che tali apparecchiature vengano trattate nel rispetto dell'ambiente e della salute della salute. Per ulteriori informazioni sui punti di raccolta delle apparecchiature da rottamare, contattare il proprio comune di residenza, il servizio di smaltimento dei rifiuti locale o il negozio presso il quale è stato acquistato il prodotto.

Eliminación de residuos de aparatos eléctricos y electrónicos por parte de usuarios domésticos en la Unión Europea
 Este símbolo en el producto o en el embalaje indica que no se puede desechar el producto junto con los residuos domésticos. Por el contrario, si debe eliminar este tipo de residuo, es su responsabilidad el llevarlo entregándolo en un punto de recogida designado de reciclado de aparatos eléctricos y electrónicos. El reciclaje y el reciclado por separado de estos residuos en el momento de la eliminación ayudará a preservar recursos naturales y a garantizar que el dispositivo propiamente se recicla y el medio ambiente. Si desea información adicional sobre los lugares donde puede dejar estos residuos para su reciclado, póngase en contacto con las autoridades locales de su ciudad, con el servicio de gestión de residuos domésticos o con la tienda donde adquirió el producto.

Likvidace vyzložíšho zařízení uživatelé v domácnosti v zemích EU
 Toto značka na produktu nebo na jeho obalu označuje, že tento produkt nesmí být likvidován společně s ostatními domácími odpady. Odpovědné za to, že vyzložíšho zařízení bude předáno příslušným orgánům pro recyklaci vyzložíšho zařízení a elektronických zařízení. Likvidace vyzložíšho zařízení samostatným způsobem a recyklaci nepožaduje zachování přírodních zdrojů a zajišťuje, že recyklace proběhne chráníc lidi a životní prostředí. Další informace o tom, kam můžete vyzložíšho zařízení předat k recyklaci, můžete získat od úřadu místní samosprávy, od společnosti provádějící svoz a likvidaci domovního odpadu nebo v obchodě, kde jste produkt zakoupili.

Bortskaffelse af affaldsudyret for brugere i private husholdninger i EU
 Dette symbol på produktet eller på dets emballage indikerer, at produktet ikke må bortskaffes sammen med andet husholdningsaffald. I stedet er det din ansvar at bortskaffe affaldsudyret ved at aflever det på et dedikeret punkt til behandling af elektrisk og elektronisk affaldsudyret. Den separate indsamling og genbrug af dit affaldsudyret på tidspunktet for bortskaffelse er med til at bevare naturlige ressourcer og sikre, at genbrug finder sted på en måde, der beskytter menneskers helbred samt miljøet. Hvis du vil vide mere om, hvor du kan aflevere dit affaldsudyret til genbrug, kan du kontakte myndighederne, dit lokale genbrugscenter, dit lokale forretningscenter eller den forretning, hvor du købte produktet.

Afvoer van afgedankte apparatuur door gebruikers in particuliere huishoudens in de Europese Unie
 Dit symbool op het product of de verpakking geeft aan dat dit product niet mag worden afgevoerd met het huishoudelijk afval. Het is u verantwoordelijkheid uw afgedankte apparatuur af te leveren op een aangewezen inzamelpunt voor de verwerking van afgedankte elektrische en elektronische apparatuur. De gescheiden inzameling en verwerking van uw afgedankte apparatuur draagt bij tot het sparen van natuurlijke bronnen en het hergebruik van materiaal op een wijze die de volksgesondheid en het milieu beschermt. Voor meer informatie over waar u uw afgedankte apparatuur kunt inleveren voor recycling kunt u contact opnemen met het gemeentehuis in uw woonplaats, de reinigingsdienst of de winkel waar u het product hebt aangekocht.

Ermojeladimastes kasusselt kõrvaldamiseks seadmete käitlemine Euroopa Liidus
 Kui tootel või toote pakendil on see sümbol, ei tohi seda toodet viiea teha koos muude kodumajapidamiste elektriliste ja elektroniliste seadmetega üheskoos ära visata. Selle asemel peate toote toimetama kindlale koostamiseks mõeldud kogumispunktile, kus seadmed eraldi kogutakse ja käitlemine toimib seadmete eraldi kogumise ja käitlemise abil. Ühiselt visamine seadmete eraldi kogumise ja käitlemise abil aitab säästuda loodusressursid ning tagada, et käitlemine toimib inimeste tervisele ja keskkonnale ohult. Lisateavet selle kohta, kuhu saate üliksõidetud seadme käitlemaks, võite saada kohalikele omavalitsustele, otsekoostamiseks mõeldud kogumispunktile või kauplusele, kust te seadme ostsite.

Hävittäminen laitteiden käsittely kotitalouksissa Euroopan unionin alueella
 Tämä huolto- tai kierrätysmerkki osoittaa, ette tämä tuote ei saa hävitä yhdessä muun kotitalouden elektrilisten ja elektronisten laitteiden kanssa. Käytännössä tämä tarkoittaa, ette hävittäminen käte käsiteltäessä laite toimittamaan sillekin, ja elektronilaisiin laitteisiin keräyspisteeseen. Hävittäminen unionin enimmäis kertyä ja kiertämis sääntöjen mukaisesti. Niin toimittamalla vähennetään myös, että luonnon resurssit säästetään, ja materiaali kierrätetään ja käsitellään ympäristöä säästävällä tavalla, joka suojaa ihmisten terveyttä ja ympäristöä. Saat tarvittavat lisätiedot lähimmästä kierrätys- tai ottekoostamiskohdasta paikallisista viranomaisista, joihinkin lähtien kukaan ei voi ottaa yhteyttä.

Απόρριψη χρηστών οικιακών συσκευών Ένωσή
 Το παρόν σύμβολο στον εξοπλισμό ή στη συσκευασία του υποδηλώνει ότι το προϊόν αυτό δεν πρέπει να πεταχτεί μαζί με άλλα οικιακά απόβλητα. Αντίθετα, ευθύνος σας είναι να απορρίψετε τις θραυστές συσκευές σε ένα καθορισμένο σημείο συλλογής απορριμμάτων για την ανακύκλωση ηλεκτρικών και ηλεκτρονικών εξοπλισμού. Η χωριστή συλλογή και ανακύκλωση των θραυστών συσκευών θα συμβάλει στη διατήρηση των φυσικών πόρων και στη διασφάλιση ότι θα ανακυκλωθούν με τέτοιο τρόπο, ώστε να προστατευτεί η υγεία των ανθρώπων και το περιβάλλον και να τηρηθούν. Για περισσότερες πληροφορίες σχετικά με το πού μπορείτε να απορρίψετε τις θραυστές συσκευές για ανακύκλωση, επικοινωνήστε με τις κατά τόπους αρμόδιες αρχές ή με το κατάστημα από το οποίο αγοράσαστε το προϊόν.

A hulladékokanyagok kezelése a magánháztartásokban az Európai Unióban
 Ez a szimbólum az írték vagy a csomagolásán jelen megjelölt szimbólum, az a jel, hogy a termék nem kezelendő együtt az egyéb háztartási hulladékkal. Az Ön feladata, hogy a készült hulladékokkal együtt elfuassza olyan kijelölt gyűjtőhelyre, amely az elektronikus hulladékokat az az elektronikus berendezések újrahasznosításával foglalkozik. A hulladékokat elkülönítetten gyűjtése és újrahasznosítása hozzájárul a természeti erőforrások megőrzéséhez, egyúttal az a biztosítja, hogy a hulladék újrahasznosítása az egészséges és a környezetet nem ártalmas módon történik. Ha további információkat szeretne kapni azokról a helyekről, ahol kezelheti újrahasznosításra a hulladékokat, forduljon a helyi önkormányzatához, a háztartási hulladék begyűjtésével foglalkozó vállalatához vagy a termék forgalmazójához.

Lietuotju atbrivinos nos nedergirm ierakstis Eiropas Savienības privātosās mējsaimniecībās
 Šis simbols uz irētes vai tās iepakojuma norāda, ka šis ierakstis nedrīkst tikt kopā ar pārējiem mējsaimniecības atkritumiem. Jūs esat atbildīgi par atbrivinos nos nedergirm ierakstis, lo nodotāto nodarītāja savākšanas vieta, lai šīs ierakstis nedergirm elektriskā un elektroniskā aprīkojuma atbrivinos pārstādītu. Speciāla nedergirm ierakstis atbrivinos pārstādītu palīdz ietaupīt dabas resursus un nodrošina tādā atbrivinos pārstādītu, kas sagrā ciliētvi veidulā un apstrādāto vidi. Lai iegūtu papildu informāciju par to, kur atbrivinos pārstādītu var nodot nedergirm ierakstis, lūdzam sazināties ar vietējo pašvaldību, mējsaimniecības atkritumu savākšanas dienestu vai veikalu, kurā iegādājāties ierakstis.

Eiropas Savienijos vartotojų ir privačių namų ūki atliekamas įrangos išmetimas
 Šis simbolis apti produktą arba jo pakavotus nurodo, kad produktas negali būti išmetamas kartu su kitomis namų ūki atliekomis. Jūs privalote išmesti savo atliekamas įrangą atskirai odami į atliekamas elektrinius ir elektroninius įrangos perdavimo punktus. Jei atliekamas įrangą bus atskirai surenkama ir perdirbiama, bus išsaugomi natūralūs ištekliai ir užtikrinama, kad įrangą yra perdirbiama žmogaus sveikatai ir gamtą tausojančiu būdu. Dėl informacijos apie tai, kur galite išmesti atliekamas perdirbti skirtą įrangą kreipkitės į atliekamas vietas kamtyb, namų ūki atliekamas perdavimo ar įvairių, kuriose parduoda produktus.

Uylizacja odpadów sprzętu przez użytkowników domowych w Unii Europejskiej
 Symbol ten umieszczony na produkcie lub opakowaniu oznacza, że tego produktu nie należy wyrzucić razem z innymi odpadami domowymi. Użytkownik jest odpowiedzialny za dostarczenie zużytego sprzętu do wyznaczonego punktu gromadzenia zużytych urządzeń elektrycznych i elektronicznych. Gromadzenie odpadów i recycling tego sprzętu odopowiadają za oszczędzenie i ochronę naturalnych zasobów i zapewnienie, że sprzęt zostanie odpowiednio przetworzony. Dodatkę informację o tym, gdzie można oddać zużyty sprzęt, można uzyskać od odpowiednich władz lokalnych, w przedsiębiorstwie zajmującym się usuwaniem odpadów lub w miejscu zakupu produktu.

Descarte de equipamentos por usuários em residências da União Europeia
 Este símbolo no produto ou no embalagem indica que o produto não pode ser descartado junto com o lixo doméstico. No entanto, é sua responsabilidade levar os equipamentos a serem descartados a um ponto de coleta designado para o reciclagem de equipamentos eletro-eletrônicos. A coleta separada e o reciclagem dos equipamentos no momento do descarte ajudam na conservação dos recursos naturais e garantem que os equipamentos serão reciclados de forma a proteger a saúde das pessoas e o meio ambiente. Para obter mais informações sobre onde descartar equipamentos para reciclagem, entre em contato com o escritório local de sua cidade, o serviço de limpeza pública de seu bairro ou a loja em que adquiriu o produto.

Postup používateľov v krajínach Európskej únie pri vyhazovaní zariadenia v domácom používaní na odpad
 Tento symbol na produkte alebo na jeho obale znamená, že nesmie byť vyhodený s iným komunálnym odpadom. Namiesto toho máte povinnos odovzdať toto zariadenie na zbernom mieste, kde sa zabezpečuje recyklácia elektrických a elektronických zariadení. Separovaný zber a recyklácia zariadenia určeného na odpad pomôže chrániť prírodné zdroje a zabezpečí taký spôsob recyklácie, ktorý bude zdravý pre životné prostredie a životnosť ľudí. Dodatek informácie o tom, kam môžete odovzdať zariadenie, môžete získať na miestnom úradnom úrade, vo firme zabezpečujúcej zber vášho komunálneho odpadu alebo v predajni, kde ste produkt kúpili.

Ravnanje z odpadno opremo v gospodinjstvih znotraj Evropske unije
 To znak na izdelku ali embalaži izdelka označuje, da izdelka ne smete oddati skupaj z drugim gospodinjstvenim odpadki. Odpadno opremo se dolžni oddati na določenem zbirnem mestu za recikliranje odpadne elektrčne in elektronske opreme. Z ločenim zbiranjem in recikliranjem odpadne opreme ob odlaganju pomaga ohraniti naravnne vire in zbiranjem, da bo odpadna oprema reciklirana tako, da se varuje zdravje ljudi in okolje. Več informacij o mestih, kjer lahko oddate odpadno opremo za recikliranje, lahko dobite na občini, v komunalnem podjetju ali trgovini, kjer ste izdelek kupili.

Kassering av förbrukningsmaterial, för hem- och privatvårdare i EU
 Produkter eller produktförpackningar med den här symbolen får inte kasseras med vanlig hushållsavfall. I stället har du ansvar för att produkten lämnas till en behörig återvinningstjänst för hantering av elektriska och elektroniska produkter. Genom separat insamling och återvinning av ditt använda utrustning kan naturliga resurser sparas och säkerställas, att utrustningen återvinns på ett sätt som skyddar människors hälsa och miljön när produkter återvinns på rätt sätt. Kommunala myndigheter, sophanteringsföretag eller butiken där varan köptes kan ge mer information om var du lämna in kasserade produkter för återvinning.

Regulatory notices

The HP All-in-One meets product requirements from regulatory agencies in your country/region.

This section contains the following topics:

- [Regulatory model identification number](#)
- [FCC statement](#)
- [HP Photosmart C5500 All-in-One series declaration of conformity](#)

Regulatory model identification number

For regulatory identification purposes, your product is assigned a Regulatory Model Number. The Regulatory Model Number for your product is SNPRB-0821. This regulatory number should not be confused with the marketing name (HP Photosmart C5500 All-in-One series, etc.) or product numbers (Q8341A, etc.).

FCC statement

FCC statement

The United States Federal Communications Commission (in 47 CFR 15.105) has specified that the following notice be brought to the attention of users of this product.

This equipment has been tested and found to comply with the limits for a Class B digital device, pursuant to Part 15 of the FCC Rules. These limits are designed to provide reasonable protection against harmful interference in a residential installation. This equipment generates, uses and can radiate radio frequency energy and, if not installed and used in accordance with the instructions, may cause harmful interference to radio communications. However, there is no guarantee that interference will not occur in a particular installation. If this equipment does cause harmful interference to radio or television reception, which can be determined by turning the equipment off and on, the user is encouraged to try to correct the interference by one or more of the following measures:

- Reorient the receiving antenna.
- Increase the separation between the equipment and the receiver.
- Connect the equipment into an outlet on a circuit different from that to which the receiver is connected.
- Consult the dealer or an experienced radio/TV technician for help.

For further information, contact:

Manager of Corporate Product Regulations
 Hewlett-Packard Company
 3000 Hanover Street
 Palo Alto, Ca 94304
 (650) 857-1501

Modifications (part 15.21)

The FCC requires the user to be notified that any changes or modifications made to this device that are not expressly approved by HP may void the user's authority to operate the equipment.

This device complies with Part 15 of the FCC Rules. Operation is subject to the following two conditions: (1) this device may not cause harmful interference, and (2) this device must accept any interference received, including interference that may cause undesired operation.

HP Photosmart C5500 All-in-One series declaration of conformity

	DECLARATION OF CONFORMITY according to ISO/IEC 17050-1 and EN 17050-1
DoC #: SNPRB-0821 - A	
Supplier's Name:	Hewlett-Packard Company
Supplier's Address:	Imaging & Printing Manufacturing Operations 60 Alexandra Terrace, #07-01 The Comtech, Singapore 118502
declares, that the product	
Product Name :	HP Photosmart C5500 All-in-One series
Regulatory Model Number: ¹⁾	SNPRB- 0821
Product Options:	All
Radio Module Name and Model :	HP Bluetooth USB2.0 Wireless Adapter BT500, SDCAB-0704
conforms to the following Product Specifications and Regulations:	
EMC :	EN 55022: 2006 / CISPR 22:2005 Class B EN 55024:1998 + A1:2001 + A2:2003 EN 61000-3-2:2000 + A2:2005 EN 61000-3-3:1995 + A1:2001 FCC CFR 47 Part 15 Class B / ICES-003, Issue 4 Class B
Safety :	EN 60950-1:2001 / IEC 60950-1:2001 EN 60825-1:1994 + A1:2002 + A2:2001
Radio :	EN 301 489-1 V1.5.1:2004 / EN 301 489-17 V1.2.1:2002 EN 300 328 V1.6.1:2004-11
Supplementary Information:	
1) This product is assigned a Regulatory Model Number which stays with the regulatory aspects of the design. The Regulatory Model Number is the main product identifier in the regulatory documentation and test reports, this number should not be confused with the marketing name or the product numbers.	
2) The product herewith complies with the requirements of the Low Voltage Directive 2006/95/EC, the EMC Directive 2004/108/EC and the R&TTE Directive 99/5/EC, and carries the CE-marking accordingly. In addition, it complies with the WEEE Directive 2002/96/EC and RoHS Directive 2002/95/EC.	
3) This device complies with part 15 of the FCC Rules. Operation is subject to the following two conditions: (1) This device may not cause harmful interference, and (2) this device must accept any interference received, including interference that may cause undesired operation.	
4) This product was tested in a typical configuration with Hewlett Packard personal computer system.	
Singapore , 18 October 2007	
Local contact for regulatory topics only:	
EMEA:	Hewlett-Packard GmbH, HQ-TRE, Herrenberger Strasse 140, 71034 Boeblingen, Germany www.hp.com/go/certificates
U.S.:	Hewlett-Packard, 3000 Hanover St., Palo Alto 94304, U.S.A. 650-857-1501

Index

Symbols/Numerics

- 10 x 15 cm photo paper
 - copy 87
 - specifications 277
- 13 x 18 cm photo paper
 - load 37
- 2 pages on 1, print 65
- 4 pages on 1, print 65
- 4 x 6 inch (10 x 15 cm)
 - borderless photos
 - print 58
- 4 x 6 inch photo paper
 - copy 87
- 5 x 7 inch photo paper, load 37

A

- A4 paper, load 37
- addresses, print 67
- after the support period 271
- align print cartridges 106
- alignment
 - failed 249
 - print cartridges 249

B

- back arrow 11
- best copy quality 88
- blank
 - copy 176
 - scan 169
- Bluetooth
 - accessibility 27
 - passkey authentication 27
 - print from a computer 24
 - security settings 27
- Bluetooth, settings 26
- booklet printing 63
- borderless photos
 - copy has borders 176
 - crop is wrong 175
 - print 58
- brightness, change in print 55
- Browsing photos 20
- buttons, control panel 10

C

- cancel
 - button 11
 - copy 92
 - print job 69
 - scan 84
- carriage
 - jam 183
 - stalled 189
- Carriage stall 245
- cartridge 105
- cartridges. *See* print cartridges
- choose paper 34
- clean
 - exterior 116
 - glass 115
 - lid backing 115
 - print cartridge contacts 108
 - print cartridge ink nozzle
 - area 111
 - print cartridges 107
- color
 - dull 141
- color graphics display
 - copy preview 86
 - crop original 91
 - shift margin 91
- color tone, change in print 55
- communication problems
 - test failed 243
 - two-way communication
 - lost 244
- connection problems
 - device not found 242
 - HP All-in-One will not turn
 - on 120
- control panel
 - buttons 10
 - features 10
 - overview 10
- copy
 - blank 176
 - borderless has borders 176
 - cancel 92
 - crop 91
 - crop is wrong 175

- default settings 89
 - fit to page fails 174
 - make a copy 85
 - margin shift 91
 - menu 12
 - missing information 174
 - number of copies 87
 - paper size 87
 - paper types,
 - recommended 87
 - photos, enhance 92
 - preview 86
 - quality 88
 - specifications 278
 - speed 88
 - text, enhance 92
 - troubleshooting 172
 - country/region, set 19
 - crop
 - borderless copy is
 - wrong 175
 - fails 233
 - crop an original 91
 - crop photos 76, 94
 - customer support
 - warranty 269, 271
- ## D
- darken
 - copies 89
 - declaration of conformity
 - European Economic
 - Area 283
 - default printer, set as 52
 - default settings
 - restore 21
 - device
 - no response 151
 - not found 242
 - device address (Bluetooth) 26
 - device name (Bluetooth) 26
 - direction pad 11
 - disconnected error 234
 - Display
 - icons 12

- display
 - change language 124
 - change measurements 125
 - sleep state 12
- documents
 - edit scanned 83
 - reprint 93
 - scan 81
- double-sided prints 62, 63

E

- edit scanned images 83
- Energy saving 21
- envelopes
 - load 42
 - specifications 277
- environment
 - Environmental product stewardship program 278
- error messages
 - memory cards 233
 - out of paper 238
 - reading or writing file 230

F

- factory defaults, restore 21
- fast copy quality 88
- fax
 - paper width incorrect 242
 - poor quality printouts 136
- fax problems
 - poor print quality 136
- file
 - invalid name 231
 - supported formats 231
 - unreadable 230
 - unsupported formats 231
- firmware revision mismatch 189
- fit to page 90
- fit to page fails 174

G

- glass
 - clean 115
- greeting cards, load 44

H

- Hagaki, load 40
- help
 - menu 13
- Home button 11

I

- images
 - crop 76, 94
 - edit scanned 83
 - reprint 93
 - rotate 75, 94
 - scan 81
 - zoom 76, 94
- improper shutdown 243
- index cards, load 40
- ink
 - drying time 237
 - low 161, 245
 - sprays inside HP All-in-One 162
 - streaks on the back of paper 146
- ink cartridges
 - HP ink depleted 267
- ink levels
 - icons 12
- ink levels, check 98
- ink supplies
 - purchase 117
- ink, removing ink from skin and clothing 104
- ink-backup mode 105
- install software,
 - troubleshoot 119
- invalid file name 231
- iron-on transfers 66

J

- jams, paper 49

L

- labels
 - load 44
 - specifications 277
- landscape orientation 54
- language, set 19
- legal paper
 - copy 87
 - load 37
 - specifications 277
- letter paper
 - copy 87
 - load 37
 - specifications 277
- lid backing, clean 115
- lighten
 - copies 89

load

- 13 x 18 cm photo paper 37
- 5 x 7 inch photo paper 37
- A4 paper 37
- envelopes 42
- full-size paper 37
- greeting cards 44
- Hagaki 40
- index cards 40
- iron-on transfers 44
- labels 44
- legal paper 37
- letter paper 37
- original 33
- postcards 40
- small-size photo paper 37
- transparencies 44

M

- maintain
 - print cartridge 105
- maintenance
 - align print cartridges 106
 - cartridges 105
 - check ink levels 98
 - clean exterior 116
 - clean glass 115
 - clean lid backing 115
 - clean print cartridges 107
 - print cartridges 97
 - remove print cartridges 273
 - replace print cartridges 99
 - restore factory defaults 21
 - self-test report 114
- make a copy 85
- margins
 - incorrect 158
 - text or graphic cut off 159
- media. *See* paper
- memory cards
 - digital camera cannot read 163
 - error message 233
 - file unreadable 230
 - HP All-in-One cannot read 164
 - insert 74
 - photos missing 231
 - save files to computer 74
 - scan to 82
 - slots 71
 - troubleshoot 162
- Menu button 11

Index

menus

- copy 12
- help 13
- scan to 13
- setup 13

missing

- information from copy 174
- text from scan 170

N

normal copy quality 88

number of copies 87

O

OK button 11

on button 11

order

- ink supplies 117
- print cartridges 117

out of paper 238

overheads, print 67

P

page order 65

paper

- choose 34
- feed fails 147
- incompatible types 36
- jam 188, 240
- jams 49, 131
- load 37
- misfeed 240
- out of 238
- recommended copy types 87
- recommended sizes for printing 52
- recommended types 34, 35
- size incorrect 241
- specifications 277
- tips 132
- type incorrect 241
- width incorrect 242

paper size

- copy setting 87

paper type 53

passkey (Bluetooth) 26

phone numbers, support 270

phone support 270

phone support period

- period for support 271

photo

- photos menu 13

Photo browsing 20

photo paper

- copy 87
- load 37
- specifications 277

photos

- add a frame 75
- add color effect 75
- adjust brightness 75
- crop 76, 94
- edit scanned 83
- flip horizontal 75
- ink sprays 162
- missing 231
- photo print cartridge 103
- print borderless 58
- print on photo paper 59
- remove red-eye 75
- rotate 75, 94
- zoom 76, 94

Pictbridge 71

poor fax printout quality 136

poor printout quality 133

portrait orientation 54

postcards

- load 40

posters 68

Power saving 21

preview copy 86

preview print job 55

print

- 2 or 4 pages on 1 65
- addresses 67
- blank printout 161
- booklet 63
- borderless fails 150
- borderless photos 58
- both sides of page 62
- cancel job 69
- correct order 65
- distorted printout 138
- envelopes 67
- envelopes print incorrectly 150
- faded 141
- from computer 51
- from software application 51
- iron-on transfers 66
- labels 67
- margins incorrect 158, 159
- meaningless characters 154

multiple pages on one sheet 65

nothing happens 154

on photo paper 59

onto a CD/DVD 61

posters 68

preview 55

print options 52, 56

quality, troubleshoot 133, 136, 139, 144

reverse images 66

reversed page order 157

self-test report 114

special print jobs 58

specifications 278

transparencies 67

troubleshooting 149

vertical streaks 145

Web pages 69

print cartridge protector 103

print cartridges

- align 106, 249
- check ink levels 98
- clean 107
- clean contacts 108
- clean ink nozzle area 111
- damaged 256
- error message 254, 256
- handle 98
- incorrect 254
- low ink 161
- low on ink 245
- missing 256
- non-HP ink 253
- order 117
- part names 98
- photo print cartridge 103
- previously used 267
- remove 273
- replace 99
- store 103

print quality

- smear ink 133

print settings

- brightness 55
- color tone 55
- layout 54
- orientation 54
- paper size 52
- paper type 53
- print quality 133
- quality 54
- reduce/enlarge 55

- resizing options 55
- resolution 54
- saturation 55
- speed 54
- printing
 - with one ink cartridge 105
- Printing Shortcuts tab 56
- problems
 - copy 172
 - error messages 182
 - print 149
 - scan 167

Q

- quality
 - print 54
- quality, copy 88

R

- Readme file 119
- recycle
 - ink cartridges 279
- red-eye, remove 75
- reduce/enlarge
 - resize 90
- regulatory notices
 - declaration of conformity (European Economic Area) 283
 - regulatory model
 - identification number 281
- reinstall software 130
- remove print cartridges 273
- removing ink from skin and clothing 104
- replace print cartridges 99
- reports
 - print cartridges 105
 - self-test 114
- reprint
 - documents 93
 - features 93
 - photos 93
- resolution
 - print 54
- restore factory settings 21
- rotate photos 75, 94

S

- saturation, change in print 55

- save
 - photos to computer 74
 - scanned image 81
- scan
 - blank 169
 - button 11
 - cancel 84
 - crop incorrect 169
 - documents 81
 - edit image 83
 - fails 168, 169
 - features 81
 - from control panel 81
 - halts 168
 - page layout incorrect 170
 - photos 81
 - save to computer 81
 - save to memory card 82
 - scan specifications 278
 - stop 84
 - text appears as dotted lines 170
 - text format incorrect 170
 - text incorrect 170
 - to memory card 82
 - troubleshooting 167
- scan glass
 - clean 115
- scan to
 - menu 13
- security
 - Bluetooth 26
 - Bluetooth adapter 27
- self-test report 114
- set
 - print options 52, 56
- settings
 - Bluetooth 26
 - country/region 19
 - language 19
- setup
 - button 11
 - menu 13
- shift left margin 91
- ship your device 273
- sleep state 12
- smear ink 133
- software application, print from 51
- software installation
 - reinstall 130
 - uninstall 130

- speed
 - copy 88
 - print 54
- start copy black 11
- start copy color 11
- stop
 - copy 92
 - print job 69
 - scan 84
- Store Demo 22
- support
 - contact 270
- support process 269
- system requirements 277

T

- T-shirt transfers. See iron-on transfers
- technical information
 - copy specifications 278
 - paper specifications 277
 - print specifications 278
 - scan specifications 278
 - system requirements 277
- telephone numbers, support 270
- text
 - cut off 159
 - dotted lines on scan 170
 - enhance on copies 92
 - incorrect format on scan 170
 - incorrect or missing on scan 170
 - jagged 148
 - meaningless characters 154
 - not filled in 136
 - smooth fonts 148
- Tips Slideshow 22
- transparencies
 - copy 87
 - load 44
 - specifications 277
- troubleshoot
 - cd/dvd print 177
 - fax problems 136
 - incorrect
 - measurements 125
 - jams, paper 49
 - language, display 124
 - print quality 133
 - Readme file 119

Index

- setup 119
- USB cable 122
- troubleshooting
 - copy 172
 - error messages 182
 - memory card 162
 - print 149
 - scan 167
- two-sided prints 62, 63

U

- uninstall software 130
- USB cable
 - communication lost 244
- USB cable installation 122

V

- visibility (Bluetooth) 26

W

- warranty 269, 271
- Web pages, print 69

Z

- zoom
 - button 11
 - buttons 76, 94
 - photos 76, 94

