

HP Photosmart C6200 All-in-One series

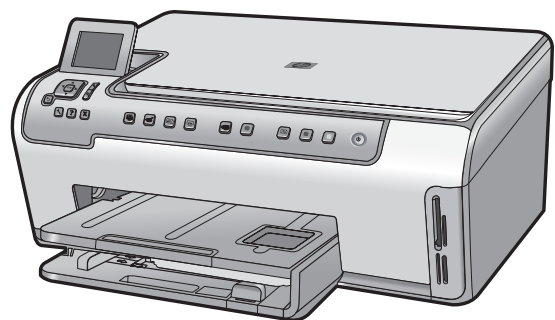

Windows Help



Contents

1	HP Photosmart C6200 All-in-One series Help	3
2	HP All-in-One overview	
	The HP All-in-One at a glance	5
	Control panel overview	6
	Menu overview	9
	Use the HP Photosmart Software	11
3	Find more information	13
4	Finish setting up the HP All-in-One	
	Set your preferences	15
	Computer connection information	17
	Connect to a network	18
5	How do I?	31
6	Load originals and load paper	
	Load originals	33
	Choose papers for printing and copying	34
	Load paper	36
	Avoid paper jams	43
7	Print from your computer	
	Print from a software application	45
	Make the HP All-in-One the default printer	46
	Change the print settings for the current job	46
	Change the default print settings	50
	Printing shortcuts	51
	Perform special print jobs	52
	Stop a print job	62
8	Use the photo features	
	View and select photos	66
	Print your photos	67
	Create special projects from your photos	69
	Share photos using HP Photosmart Software	70
	Save photos to your computer	71
	Edit photos using the control panel	72
9	Use the scan features	
	Make reprints of your photos	79
	Scan an image	80
	Edit a scanned image	82
	Share a scanned image with friends and relatives	83
	Stop scanning	83

10 Use the copy features	
Make a copy.....	85
Preview your copy job.....	85
Change the copy settings for the current job.....	86
Change default copy settings.....	89
Perform special copy jobs.....	89
Stop copying.....	93
11 Print reports and forms	
Print a self-test report.....	95
Print forms.....	96
12 Maintain the HP All-in-One	
Clean the HP All-in-One.....	97
Check the estimated ink levels.....	98
Work with ink cartridges.....	99
Reduce energy consumption when the HP All-in-One is off.....	106
Self-maintenance sounds.....	106
Turn off the HP All-in-One.....	106
13 Shop for ink supplies.....	107
14 Troubleshooting	
Troubleshooting tips.....	109
Hardware setup troubleshooting.....	112
Software installation troubleshooting.....	116
Network troubleshooting.....	120
Print quality troubleshooting.....	123
Print troubleshooting.....	131
Memory card troubleshooting.....	139
Scan troubleshooting.....	142
Copy troubleshooting.....	145
Errors.....	149
15 HP warranty and support	
Warranty.....	169
Ink cartridge warranty information.....	169
Support process.....	170
Before you call HP support.....	170
HP support by phone.....	171
Additional warranty options.....	171
HP Quick Exchange Service (Japan).....	172
HP Korea customer support.....	172
Prepare the HP All-in-One for shipment.....	173
Pack the HP All-in-One.....	174
16 Technical information	
Specifications.....	175
Environmental product stewardship program.....	176
Regulatory notices.....	179
Index.....	183

1 HP Photosmart C6200 All-in-One series Help

For information about the HP All-in-One, see:

- [“HP All-in-One overview”](#) on page 5
- [“Find more information”](#) on page 13
- [“Finish setting up the HP All-in-One”](#) on page 15
- [“How do I?”](#) on page 31
- [“Load originals and load paper”](#) on page 33
- [“Print from your computer”](#) on page 45
- [“Use the photo features”](#) on page 65
- [“Use the scan features”](#) on page 79
- [“Use the copy features”](#) on page 85
- [“Print reports and forms”](#) on page 95
- [“Maintain the HP All-in-One”](#) on page 97
- [“Shop for ink supplies”](#) on page 107
- [“HP warranty and support”](#) on page 169
- [“Technical information”](#) on page 175

2 HP All-in-One overview

Use the HP All-in-One to quickly and easily make copies, scan documents, or print photos from a memory card. HP papers that are specifically designed for the type of project you are printing produce the best results. The Two-sided printing accessory included with the HP All-in-One lets you print on both sides of the page, so you can print brochures and booklets, or just save paper.

The HP All-in-One also provides built-in templates that you can use to print narrow- and wide-ruled notebook paper, graph paper, or music sheets that are perfect for your child's homework assignments. You can even print a task checklist to keep track of your list of things to do. You can access many HP All-in-One functions directly from the control panel, without turning on your computer.

This section contains the following topics:

- [The HP All-in-One at a glance](#)
- [Control panel overview](#)
- [Menu overview](#)
- [Use the HP Photosmart Software](#)

The HP All-in-One at a glance

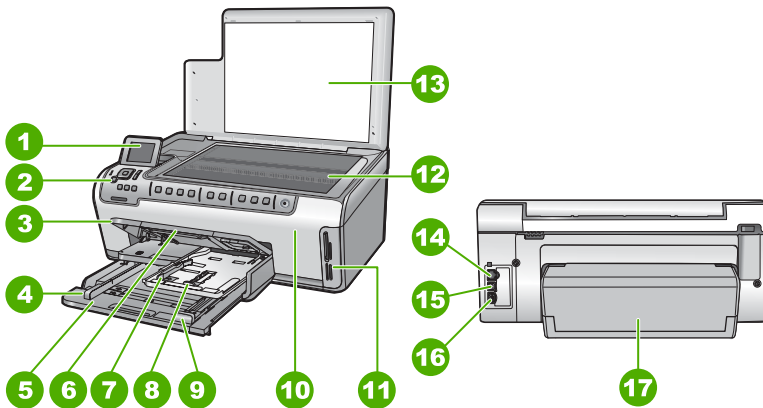

Label	Description
1	Color graphics display (also referred to as the display)
2	Control panel
3	Output tray (currently shown in the up position)
4	Paper-width guide for the main input tray
5	Main input tray (also referred to as the input tray)

(continued)

Label	Description
6	Paper tray extender (also referred to as the tray extender)
7	Paper-width and paper-length guides for the photo tray
8	Photo tray
9	Paper-length guide for the main input tray
10	Ink cartridge door
11	Memory card slots
12	Glass
13	Lid backing
14	Ethernet port
15	USB port
16	Power connection*
17	Two-sided printing accessory

* Use only with the power adapter supplied by HP.

Control panel overview

This section describes the functions of the control panel buttons and lights, as well as the icons and sleep state on the display.

This section contains the following topics:







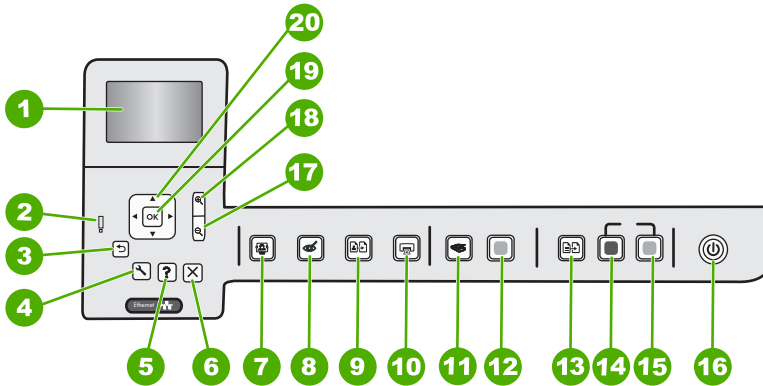

- [Control panel features](#)
- [Display icons](#)
- [Display sleep state](#)

Control panel features

The following diagram and related table provide a quick reference to the HP All-in-One control panel features.





Label	Icon	Name and Description
1		Color graphics display (also referred to as the display): Displays menus, photos, and messages. The display can be pulled up and angled for better viewing.
2		Attention light: Indicates a problem occurred. See the display for more information.
3		Back: Returns to the previous screen on the display.
4		Setup: Opens the Setup menu where you can generate reports, change device settings, and perform maintenance functions.
5		Help: Opens the Help Menu menu on the display where you can select a topic to learn more about it. From the idle state, pressing Help lists a menu of items for which help is available. Depending on the topic you select, the topic will appear on your display or on your computer screen. When viewing screens other than Idle, the Help button provides context sensitive help.
6		Cancel: Stops the current operation.
7		Photo Menu: Launches the Photosmart Express menu for printing, saving, editing, and sharing photos.
8		Red Eye Removal: Turns the Red Eye Removal feature on or off. By default, this feature is turned off. When the feature is turned on, the HP All-in-One automatically corrects red eye coloring in the photo currently shown on the display.
9		Photo Reprints: Enables you to make a copy of an original photo placed on the glass.
10		Print Photos: Depending on whether you access your photos from the View , Print , or Create menu, the Print Photos button will display the Print Preview screen or it will print any selected photo(s). If no photos are selected, a prompt appears asking if you want to print all the photos on your card.



Label	Icon	Name and Description
11		Scan Menu: Opens the Scan Menu where you can select a destination for your scan.
12		Start Scan: Starts a scan.
13		Copy Menu: Opens the Copy Menu where you can select copy options, such as number of copies, paper size, and paper type.
14		Start Copy Black: Starts a black-and-white copy.
15		Start Copy Color: Starts a color copy.
16		On: Turns the HP All-in-One on or off. When the HP All-in-One is off, a minimal amount of power is still supplied to the device. You can further reduce power supply by holding down the On button for 3 seconds. This will put the HP All-in-One in Standby/Off state. To completely remove power, turn the HP All-in-One off, and then unplug the power cord.
17		Zoom out - (magnifying glass icon): Zooms out to show more of a photo. If you press this button when a photo is shown on the display at 100%, the Fit to Page feature is applied to the photo automatically.
18		Zoom in + (magnifying glass icon): Zooms in to enlarge the image on the display. You can also use this button together with the arrows on the directional pad to adjust the crop box for printing.
19	OK	OK: Selects a menu setting, value, or photo on the display.
20		Directional pad: Allows you to navigate through photos and menu options by pressing the up, down, left, or right arrow buttons. If you are zooming in on a photo, you can also use the arrow buttons to pan around the photo and select a different area to print.

Display icons

The following icons can appear at the bottom of the display to provide important information about the HP All-in-One.

Icon	Purpose
	Shows the ink cartridge status. The color of the icon corresponds to the color of the ink cartridge, and the fill level of the icon corresponds to the fill level of the ink cartridge. NOTE: The ink level icons will only appear if one of the ink cartridges is less than 50% full. If the ink level for all ink cartridges is more than 50% full, the ink cartridge icons do not appear on the display.
	Shows that the ink cartridge is nearly empty, and will need to be replaced.

(continued)

Icon	Purpose
	Shows that an unknown ink cartridge is inserted. This icon might appear if an ink cartridge contains non-HP ink.
	Indicates that there is a wired network connection.

Display sleep state

To prolong the life of the display, it dims after two minutes of inactivity. After 60 minutes of inactivity, the display goes into a sleep state and the screen shuts off completely. The display turns back on when you press a control panel button, insert a memory card, lift the lid, or access the HP All-in-One from a connected computer.

Menu overview

The following topics provide a quick reference to top-level menus that appear on the HP All-in-One display.





- [Photosmart Express Menu](#)
- [Scan Menu](#)
- [Setup Menu](#)
- [Copy Menu](#)
- [Help Menu](#)

Photosmart Express Menu

The following options are available in the **Photosmart Express** menu when you insert a memory card or press **Photo Menu** on the control panel.



View

 Print	 Create	 Share	 Save
---	--	---	--

Scan Menu

The following options are available when you press the **Scan Menu** button on the control panel.

 **NOTE:** The applications that appear on the **Scan Menu** vary depending on the software applications installed on your computer.

- Scan and Reprint
- Scan to Memory Card
- HP Photosmart Premier
- Scan to Computer

 **NOTE:** The **Scan to Computer** option only appears if the HP All-in-One is network-connected.

Setup Menu

The following options are available when you press the **Setup** button on the control panel.

- Printable School Papers
- Tools
- Preferences

Network

Copy Menu

The following options are available when you press the **Copy Menu** button on the control panel.

Copies
Size
Quality
Lighter/Darker
Preview
Crop
Paper Size
Paper Type
Margin Shift
Enhancements
Set As New Defaults

Help Menu

The **Help Menu** menu provides quick access to key help topics and is available when you press the **Help** button. If you select one of the first six topics, the help appears on the display. If you select one of the remaining topics, the help appears on your computer. The following options are available.

Use Control Panel
Insert Ink Cartridges
Load Paper in Photo Tray
Load Paper in Main Tray
Load Original on Scanner
How Do I
Error Messages
General Troubleshooting
Networking Troubleshooting
Use Memory Card
Get Support

Use the HP Photosmart Software





The HP Photosmart Software provides a fast and easy way to make prints of your photos. It also provides access to other basic HP imaging software features, such as saving and viewing your photos.

For more information on using the HP Photosmart Software:

- Check the **Contents** panel on the left. Look for the **HP Photosmart Software Help contents** book at the top.
- If you do not see the **HP Photosmart Software Help contents** book at the top of the **Contents** panel, access the software help through the HP Solution Center.

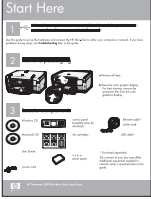
3 Find more information

You can access a variety of resources, both printed and onscreen, that provide information about setting up and using the HP All-in-One.

	<p>Setup Guide</p> <p>The Setup Guide provides instructions for setting up the HP All-in-One and installing software. Make sure you follow the steps in the Setup Guide in order. If you have problems during setup, check the Setup Guide for troubleshooting information, or see "Troubleshooting" on page 109 in this onscreen Help.</p>
	<p>Basics Guide</p> <p>The Basics Guide contains an overview of the HP All-in-One, including step-by-step instructions for basic tasks, troubleshooting tips, and technical information.</p>
	<p>HP Photosmart animations</p> <p>The HP Photosmart animations, located in the relevant sections of the onscreen Help, show you how to complete key tasks on the HP All-in-One. You will learn how to load paper, insert a memory card, and replace ink.</p>
	<p>Onscreen Help</p> <p>The onscreen Help provides detailed instructions on using all features of the HP All-in-One.</p> <ul style="list-style-type: none">• The How Do I? topic provides links so you can quickly find information on performing common tasks.• The HP All-in-One overview topic provides general information about the main features of the HP All-in-One.• The Troubleshooting topic provides information about resolving errors you might encounter with the HP All-in-One.
	<p>Readme</p> <p>The Readme file contains the most recent information which might not be found in other publications.</p> <p>Install the software to access the Readme file.</p>
<p>www.hp.com/support</p>	<p>If you have Internet access, you can get help and support from the HP Web site. This Web site offers technical support, drivers, supplies, and ordering information.</p>

4 Finish setting up the HP All-in-One

After you have completed the steps in your Setup Guide, refer to this section to help you finish setting up the HP All-in-One. This section contains important setup-related information for your device, including information on setting preferences.

This section contains the following topics:

- [Set your preferences](#)
- [Computer connection information](#)
- [Connect to a network](#)

Set your preferences

You can change the settings on the HP All-in-One so that it behaves according to your preference. For example, you can set general device preferences, such as the language used to display messages. You can also restore the device settings to what they were when you purchased your device. This will erase any new defaults you have set.

This section contains the following topics:

- [Set your language and country/region](#)
- [Set the default paper tray for DPOF printing](#)
- [Enable faster browsing of photos](#)
- [Restore the factory defaults](#)
- [Play a slideshow on the display](#)

Set your language and country/region

The language setting determines which language the HP All-in-One uses to show messages on the display. The country/region setting determines the default paper sizes and layouts for printing. You can change these settings at any time by using the following procedures.

To set your language

1. Press **Setup**.
2. Press ▼ to highlight **Preferences**, and then press **OK**.
3. Press ▼ to highlight **Set Language**, and then press **OK**.
4. Press ▼ to scroll through the languages. When the language you want to use appears, press **OK**.
5. When prompted to confirm the language, press ▼ to highlight **Yes** or **No**, and then press **OK**.

To set your country/region

1. Press **Setup**.
2. Press ▼ to highlight **Preferences**, and then press **OK**.

3. Press ▼ to highlight **Set Country/Region**, and then press **OK**.
4. Press ▼ to scroll through the countries/regions. When the country/region you want to use appears, press **OK**.
5. When prompted to confirm the country/region, press ▼ to highlight **Yes** or **No**, and then press **OK**.

Set the default paper tray for DPOF printing

Set the default paper tray to use when you print photos from a DPOF file. The default setting is **Photo Tray**.

To set the default paper tray

1. Press **Setup**.
2. Press ▼ to highlight **Preferences**, and then press **OK**.
3. Press ▼ to highlight **DPOF Tray Select**, and then press **OK**.
4. Press ▼ or ▲ to highlight **Main Tray** or **Photo Tray**, and then press **OK** to select the tray you want.

Enable faster browsing of photos

You can set up the HP All-in-One to enable faster photo browsing by writing small thumbnails to the memory card. The thumbnails take up a relatively small amount of space and are used to speed up the browsing performance of photos on the card.

 **NOTE:** This feature is on by default.

To turn faster browsing on or off

1. Press **Setup**.
2. Press ▼ to highlight **Preferences**, and then press **OK**.
3. Press ▼ to highlight **Enable Faster Browsing**, and then press **OK**.
4. Press ▼ or ▲ to highlight **On** or **Off**, and then press **OK**.

Restore the factory defaults

You can restore the current settings to what they were when you purchased the HP All-in-One.

 **NOTE:** Restoring the factory defaults will not affect any changes you made to scan settings and the language and country/region settings.

You can perform this process from the control panel only.

To restore the factory defaults

1. Press **Setup**.
2. Press ▼ to highlight **Tools**, and then press **OK**.
3. Press ▼ to highlight **Restore Factory Defaults**, and then press **OK**.
The factory default settings are restored.

Play a slideshow on the display

You can set up the HP All-in-One to play a slideshow on the display, similar to a screensaver on a computer, when you are not using the device.

There are two types of slideshows that you can enable:

- **Demo Mode:** appears after the HP All-in-One is inactive for one minute and shows a set of predefined graphics that describe features of the device. The slideshow plays until you press a button or use the device. If the HP All-in-One remains inactive for eight hours, the display turns off. **Demo Mode** is off by default.



NOTE: HP recommends leaving **Demo Mode** off.

- **Tips Slideshow:** appears only after you print from the computer. The HP All-in-One shows a set of predefined slides with information about special features that you can do with the device. The slideshow plays through once and then the display returns to the main menu. **Tips Slideshow** is on by default.

To turn the demo mode on or off

1. Press **Setup**.
2. Press ▼ to highlight **Tools**, and then press **OK**.
3. Press ▼ to highlight **Demo Mode**, and then press **OK**.
4. Press ▼ or ▲ to highlight **On** or **Off**, and then press **OK**.

To turn the tips slideshow on or off

1. Press **Setup**.
2. Press ▼ to highlight **Tools**, and then press **OK**.
3. Press ▼ to highlight **Tips Slideshow**, and then press **OK**.
4. Press ▼ or ▲ to highlight **On** or **Off**, and then press **OK**.

Computer connection information

You can use the HP All-in-One as a stand-alone copier and photo printer, or you can connect the HP All-in-One to a computer to enable printing and other software features.

This section contains the following topics:

- [Supported connection types](#)
- [Connect using Ethernet](#)
- [Use printer sharing](#)

Supported connection types

Description	Recommended number of connected computers for best performance	Supported software features	Setup instructions
USB connection	One computer connected with a USB cable to the	All features are supported, except Webscan.	Follow the Setup Guide for detailed instructions.

Description	Recommended number of connected computers for best performance	Supported software features	Setup instructions
	rear USB 2.0 High Speed port on the HP All-in-One.		
Ethernet (wired) connection	Up to five computers connected to an HP All-in-One using a hub or router.	All features are supported, including Webscan.	Follow the instructions in “Wired network setup” on page 19.
Printer sharing	Up to five computers. The host computer must be turned on at all times, or the other computers will not be able to print to the HP All-in-One.	All features resident on the host computer are supported. Only print is supported from the other computers.	Follow the instructions in “Use printer sharing” on page 18.

Connect using Ethernet

The HP All-in-One supports both 10 Mbps and 100 Mbps Ethernet network connections. For detailed instructions on connecting the HP All-in-One to an Ethernet (wired) network, see [“Wired network setup”](#) on page 19.

Use printer sharing

If your computer is on a network, and another computer on the network has an HP All-in-One connected to it by a USB cable, you can print to that printer using printer sharing.

The computer directly connected to the HP All-in-One acts as the **host** for the printer and has full software functionality. The other computer, which is referred to as a **client**, has access only to the print features. You must perform other functions from the host computer or from the control panel on the HP All-in-One.

To enable printer sharing on a Windows computer

- ▲ Refer to the user guide that came with your computer or see the Windows onscreen Help.

Connect to a network

This section describes how to connect the HP All-in-One to a network and how to view and manage network settings.

If you want to:	See this section:
Connect to a wired (Ethernet) network.	“Wired network setup” on page 19
Install the HP All-in-One software for use in a networked environment.	“Install the software for a network connection” on page 21
Add connections to more computers on the network.	“Connect to additional computers on a network” on page 22

(continued)

If you want to:	See this section:
Change the HP All-in-One from a USB connection to a network connection. NOTE: Use the instructions in this section if you first installed the HP All-in-One with a USB connection, and you now want to change to an Ethernet network connection.	“Change the HP All-in-One from a USB connection to a network connection” on page 22
View or change the network settings.	“Manage your network settings” on page 22
Find definitions of networking terms.	“Network glossary” on page 29
Find troubleshooting information.	“Network troubleshooting” on page 120

Wired network setup

This section describes how to connect the HP All-in-One to a router, switch, or hub using an Ethernet cable and how to install the HP All-in-One software for a network connection. This is known as a wired or Ethernet network.

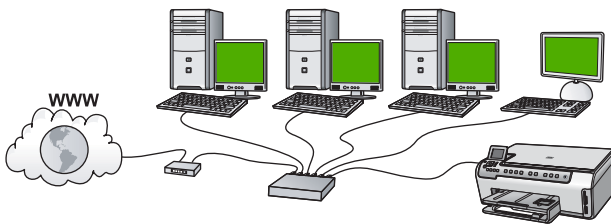

To set up the HP All-in-One on a wired network, you need to do the following:	See this section:
First, collect all of the required materials.	“What you need for a wired network” on page 19
Next, connect to a wired network.	“Connect the HP All-in-One to the network” on page 20
Finally, install the software.	“Install the software for a network connection” on page 21

What you need for a wired network

Before you connect the HP All-in-One to a network, make sure you have all of the required materials.

- ❑ A functional Ethernet network that includes a router, switch, or hub with an Ethernet port.
- ❑ CAT-5 Ethernet cable.

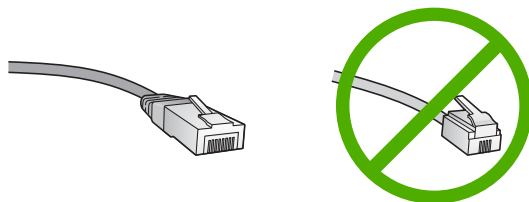

Although standard Ethernet cables look similar to standard telephone cables, they are not interchangeable. There is a different number of wires in each one, and each has a different connector. An Ethernet cable connector (also called an RJ-45 connector) is wider and thicker and always has 8 contacts on the end. A phone connector has between 2 and 6 contacts.

- ❑ A desktop computer or laptop with an Ethernet connection.

 **NOTE:** The HP All-in-One supports both 10 Mbps and 100 Mbps Ethernet networks. If you are purchasing, or have purchased, a network interface card (NIC), make sure it can operate at either speed.

Connect the HP All-in-One to the network

To connect the HP All-in-One to the network, use the Ethernet port on the back of the device.

To connect the HP All-in-One to the network

1. Remove the yellow plug from the back of the HP All-in-One.

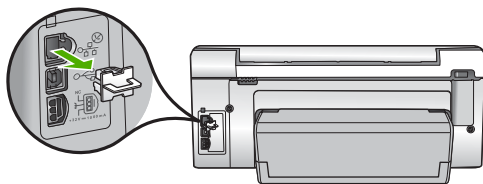

2. Connect the Ethernet cable to the Ethernet port on the back of the HP All-in-One.

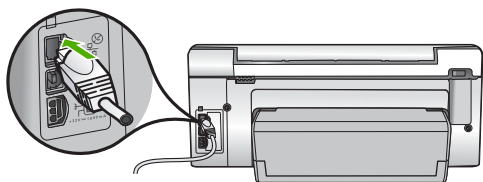

3. Connect the other end of the Ethernet cable to an available port on your Ethernet router or switch.

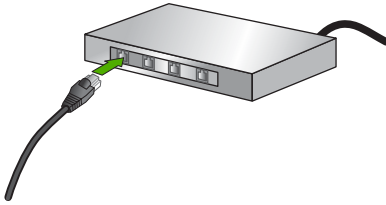

4. Once you have connected the HP All-in-One to the network, install the software.

Related topics

[“Install the software for a network connection” on page 21](#)

Install the software for a network connection

Use this section to install the HP All-in-One software on a computer connected to a network. Before you install the software, make sure you have connected the HP All-in-One to a network.

 **NOTE:** If your computer is configured to connect to a series of network drives, make sure that your computer is currently connected to these drives before installing the software. Otherwise, HP All-in-One installation software might try to use one of the reserved drive letters, and you will not be able to access that network drive on your computer.

NOTE: Installation time can range from 20 to 45 minutes depending on your operating system, the amount of available space, and the processor speed of your computer.

To install the Windows HP All-in-One software

1. Quit all applications running on your computer, including any virus detection software.
2. Insert the Windows CD that came with the HP All-in-One into the CD-ROM drive on your computer and follow the onscreen instructions.
3. If a dialog box about firewalls appears, follow the instructions. If you see firewall pop-up messages, you must always accept or allow the pop-up messages.
4. On the **Connection Type** screen, select **Through the network**, and then click **Next**.
The **Searching** screen appears as the Setup program searches for the HP All-in-One on the network.
5. On the **Printer Found** screen, verify that the printer description is correct. If more than one printer is found on the network, the **Printers Found** screen appears. Select the HP All-in-One you want to connect.
6. Follow the prompts to install the software.
When you have finished installing the software, the HP All-in-One is ready for use.

7. If you disabled any virus detection software on your computer, make sure to enable it again.
8. To test your network connection, go to your computer and print a self-test report to the HP All-in-One.

Related topics

- [“View and print network settings” on page 23](#)
- [“Print a self-test report” on page 95](#)

Connect to additional computers on a network

You can connect the HP All-in-One to more than one computer on a small network of computers. If the HP All-in-One is already connected to a computer on a network, for each additional computer you must install the HP All-in-One software. Once you have set up the HP All-in-One on the network you will not need to configure it again when you add additional computers.

Related topics

[“Install the software for a network connection” on page 21](#)

Change the HP All-in-One from a USB connection to a network connection

If you first install the HP All-in-One with a USB connection, you can later change to an Ethernet network connection. If you already understand how to connect to a network, you can use the general directions below.

To change a USB connection to a wired (Ethernet) connection

1. Unplug the USB connection from the back of the HP All-in-One.
2. Connect an Ethernet cable from the Ethernet port on the back of the HP All-in-One to an available Ethernet port on the router or switch.
3. Install the software for a network connection, choose **Add a Device**, and then choose **Through the network**.
4. When the installation is complete, open **Printers and Faxes** (or **Printers**) in the **Control Panel** and delete the printers from the previous USB installation.

For more detailed instructions on connecting the HP All-in-One to a network, see:

[“Wired network setup” on page 19](#)

Manage your network settings

You can manage network settings for the HP All-in-One through the HP All-in-One control panel. Additional advanced settings are available in the Embedded Web Server, a configuration and status tool you access from your Web browser using an existing network connection to the HP All-in-One.

This section contains the following topics:

- [Change basic network settings from the control panel](#)
- [Change advanced network settings from the control panel settings](#)

- [Use the Embedded Web Server](#)
- [Network configuration page definitions](#)

Change basic network settings from the control panel

You can perform a variety of network management tasks from the control panel, such as printing the network settings and restoring network defaults.

This section contains the following topics:

- [View and print network settings](#)
- [Restore network defaults](#)

View and print network settings

You can display a summary of the network settings on the HP All-in-One control panel, or you can print a more detailed configuration page. The network configuration page lists all of the important network settings such as the IP address, link speed, DNS, and mDNS.

To view and print the network settings

1. On the control panel of the HP All-in-One, press **Setup**.
2. Press ▼ until **Network** is highlighted, and then press **OK**.
The **Network Menu** appears.
3. Press ▼ until **View Network Settings** is highlighted, and then press **OK**.
The **View Network Settings Menu** appears.
4. Do one of the following:
 - To display wired network settings, press ▼ until **Display Wired Summary** is highlighted, and then press **OK**.
This displays a summary of the wired (Ethernet) network settings.
 - To print the network configuration page, press ▼ until **Print Network Configuration Page** is highlighted, and then press **OK**.
This prints the network configuration page.

Related topics

[“Network configuration page definitions” on page 26](#)

Restore network defaults

You can reset the network settings to what they were when you purchased the HP All-in-One.

To restore network defaults

1. On the control panel of the HP All-in-One, press **Setup**.
2. Press ▼ until **Network** is highlighted, and then press **OK**.
3. Press ▼ until **Restore Network Defaults** is highlighted, and then press **OK**.
4. Press **OK** to confirm that you want to restore the network defaults.

Change advanced network settings from the control panel settings

The advanced network settings are provided for your convenience. However, unless you are an advanced user, you should not change any of these settings.

This section contains the following topics:

- [Set link speed](#)
- [Change IP settings](#)

Set link speed

You can change the speed at which data is transmitted over the network. The default is **Automatic**.

To set link speed

1. Press **Setup**.
2. Press ▼ until **Network** is highlighted, then press **OK**.
The **Network Menu** appears.
3. Press ▼ until **Advanced Setup** is highlighted, and then press **OK**.
Press ▼ until **Set Link Speed** is highlighted, and then press **OK**.
4. Press ▼ to select the link speed that matches your network hardware, and then press **OK** to confirm the setting.
 - **Automatic**
 - **10-Full**
 - **10-Half**
 - **100-Full**
 - **100-Half**

Change IP settings

The default setting for the IP settings is **Automatic**, which sets the IP settings automatically. However, if you are an advanced user, you might want to manually change the IP address, subnet mask, or the default gateway. To see the IP address and subnet mask of the HP All-in-One, print a network configuration page from the HP All-in-One.

 **NOTE:** When manually entering an IP Setting, you must already be connected to an active Network, otherwise the setting will not stay when you exit from the menu.

 **CAUTION:** Be careful when manually assigning an IP address. If you enter an invalid IP address during the installation, your network components will not be able to connect with the HP All-in-One.

To change IP settings

1. Press **Setup**.
2. Press ▼ until **Network** is highlighted, then press **OK**.
The **Network Menu** appears.
3. Press ▼ until **Advanced Setup** is highlighted, and then press **OK**.
4. Press ▼ until **IP Settings** is highlighted, and then press **OK**.
If the HP All-in-One is already connected to a wired network, you are prompted to confirm that you want to change the IP settings. Press **OK**.
5. Press ▼ until **Manual** is highlighted, and then press **OK**.

6. Press ▼ to highlight one of the following IP settings, and then press **OK**.
 - **IP Address**
 - **Subnet Mask**
 - **Default Gateway**
7. Enter your changes, and then press **OK** to confirm the setting.

Related topics

- [“View and print network settings” on page 23](#)
- [“Network configuration page definitions” on page 26](#)

Use the Embedded Web Server

If your computer is connected to an HP All-in-One on a network, you can access the Embedded Web Server that resides in the HP All-in-One. The Embedded Web Server is a web-based user interface that provides some options not available on the HP All-in-One control panel, including Webscan, a feature that lets you scan photos and documents from the HP All-in-One to your computer using a Web browser, and advanced network security options. Also, the Embedded Web Server enables you to monitor status, change device preferences, and order printer supplies.

 **NOTE:** Use the Embedded Web Server to change network settings not available on the control panel.

This section contains the following topics:

- [Access the Embedded Web Server](#)
- [Use the Embedded Web Server to modify network settings](#)

Access the Embedded Web Server

The computer you use to access the Embedded Web Server on the HP All-in-One must be connected to the same network as the HP All-in-One.

To access the Embedded Web Server

1. Print a network configuration page to find the IP address for the HP All-in-One.
2. In the **Address** box in your Web browser on your computer, type the IP address of the HP All-in-One, as shown on the network settings page. For example, `http://192.168.1.101`.
The Embedded Web Server **Information** page appears, showing information for the HP All-in-One.

 **NOTE:** If you are using a proxy server in your browser, you might need to disable it to access the Embedded Web Server.

3. If you need to change the language displayed in the Embedded Web Server, do the following:
 - a. Click the **Information** tab.
 - b. Click **Language** in the navigation menu.
 - c. In the **Language** list, click the appropriate language.
 - d. Click **Apply**.

4. Click the **Settings** tab to access device settings.
5. Make any configuration changes, and then click **Apply**.
6. Close the Embedded Web Server.

Related topics

[“View and print network settings” on page 23](#)

Use the Embedded Web Server to modify network settings

The Embedded Web Server gives you an intuitive interface to your network connection parameters.

To use the Embedded Web Server to modify network settings

1. Print a network configuration page to find the IP address for the HP All-in-One.
2. In the **Address** box in your Web browser on your computer, type the IP address of the HP All-in-One, as shown on the network settings page. For example, `http://192.168.1.101`.

The Embedded Web Server **Information** page appears, showing information for the HP All-in-One.



NOTE: If you are using a proxy server in your browser, you might need to disable it to access the Embedded Web Server.

3. Click the **Networking** tab.
4. Click **Wired (802.3)** in the navigation menu.
5. Make your changes, and then click **Apply**.

Related topics

[“View and print network settings” on page 23](#)

Network configuration page definitions

The network configuration page shows the network settings for the HP All-in-One. There are settings for general information and 802.3 wired (Ethernet).

For information on how to print a network configuration page, see [“View and print network settings” on page 23](#). For additional information on terms used here, see the [“Network glossary” on page 29](#).

This section contains the following topics:

- [General network settings](#)
- [Wired \(802.3\) network settings](#)

General network settings

The following table describes the general network settings shown on the network configuration page.

Parameter	Description
Network Status	Status of the HP All-in-One: <ul style="list-style-type: none"> • Ready: The HP All-in-One is ready to receive or transmit data. • Offline: The HP All-in-One is not currently connected to the network.
Active connection type	Network mode of the HP All-in-One: <ul style="list-style-type: none"> • Wired: The HP All-in-One is connected by Ethernet cable to an IEEE 802.3 network. • None: There is no network connection.
URL	The IP address of the Embedded Web Server. NOTE: You will need to know this URL when you try to access the Embedded Web Server.
Firmware Revision	The internal networking component and device firmware revision code. NOTE: If you call HP support, depending on the problem, you might be asked to provide the firmware revision code.
Hostname	The TCP/IP name assigned by the installation software to the device. By default, this is the letters HP followed by the last 6 digits of the Media Access Control (MAC) address.
Admin Password	Status of the administrator's password for the Embedded Web Server: <ul style="list-style-type: none"> • Set: Password is specified. You must enter the password to make changes to the Embedded Web Server parameters. • Not Set: No password is set. A password is not required for making changes to the Embedded Web Server parameters.
mDNS	Some local and ad hoc networks do not use central DNS servers. They use a DNS alternative called mDNS. With mDNS, your computer can find and use any HP All-in-One connected to your local area network. It can also work with any other Ethernet-enabled device that appears on the network.

Wired (802.3) network settings

The following table describes the 802.3 wired network settings shown on the network configuration page.

Parameter	Description
Hardware Address (MAC)	The Media Access Control (MAC) address that identifies the HP All-in-One. This is a unique 12-digit identification number assigned to networking hardware for identification, including routers, switches, and other such devices. No two pieces of hardware have the same MAC address.

(continued)

Parameter	Description
	<p>NOTE: Some Internet service providers (ISPs) require that you register the MAC address of the Network Card or LAN Adapter that was connected to your cable or DSL modem during installation.</p>
IP Address	<p>This address uniquely identifies the device on the network. IP addresses are assigned dynamically through DHCP or AutoIP. You can also set up a static IP address, though this is not recommended.</p> <p>CAUTION: Be careful when manually assigning an IP address. An invalid IP address during installation will prevent your network components from seeing the HP All-in-One.</p>
Subnet Mask	<p>A subnet is an IP address assigned by the installation software to make an additional network available as part of a larger network. Subnets are specified by a subnet mask. This mask determines which of the HP All-in-One IP address bits identify the network and subnet, and which bits identify the device itself.</p> <p>NOTE: It is recommended that the HP All-in-One and the computers that use it all reside on the same subnet.</p>
Default Gateway	<p>A node on a network that serves as an entrance to another network. A node in this instance can be a computer or some other device.</p> <p>NOTE: The address of the default gateway is assigned by the installation software, unless you have already set a manual IP address.</p>
Configuration Source	<p>The protocol used to assign the IP address to the HP All-in-One:</p> <ul style="list-style-type: none"> • AutoIP: The installation software automatically determines the configuration parameters. • DHCP: The configuration parameters are supplied by a dynamic host configuration protocol (DHCP) server on the network. On small networks, this could be a router. • Manual: The configuration parameters are set manually, such as a static IP address. • Not Specified: The mode used when the HP All-in-One is initializing.
DNS server	<p>The IP address of the domain name service (DNS) for the network. When you use the web or send an e-mail message, you use a domain name to do it. For example, the URL http://www.hp.com contains the domain name hp.com. The DNS on the Internet translates the domain name into an IP address. Devices use the IP addresses to refer to one another.</p> <ul style="list-style-type: none"> • IP Address: The IP address of the domain name server. • Not Specified: The IP address is not specified, or the device is initializing. <p>NOTE: Check to see if a DNS IP address appears on the network configuration page. If no address is shown, obtain the DNS IP address from your Internet service provider (ISP).</p>
Link Configuration	<p>The speed at which data is transmitted over a network. Speeds include 10TX-Full, 10TX-Half, 100TX-Full, and 100TX-Half. When set to None, networking is disabled.</p>
Total Packets transmitted	<p>The number of packets transmitted by the HP All-in-One without error since it has been turned on. The counter clears after the HP All-in-One is turned off. When a message is transmitted over a packet-switching network, it is</p>

(continued)

Parameter	Description
	broken up into packets. Each packet contains the destination address as well as the data.
Total Packets received	The number of packets received by the HP All-in-One without error since it has been turned on. The counter clears after the HP All-in-One is turned off.

Network glossary

access point	A network router that has wireless capability.
ASCII	American Standard Code for Information Interchange. The standard for numbers used by computers to represent all the uppercase and lowercase Latin letters, numbers, punctuation, etc.
AutoIP	A feature of the installation software, which determines the configuration parameters of devices on the network.
DHCP	Dynamic Host Configuration Protocol. A server on the network that supplies configuration parameters to devices on the network. On small networks, this could be a router.
DNS	Domain Name Service. When you use the Web or send an e-mail message, you use a domain name to do it. For example, the URL http://www.hp.com contains the domain name hp.com. The DNS on the Internet translates the domain name into an IP address. Devices use the IP addresses to refer to one another.
DNS-SD	See DNS. The SD portion stands for Service Discovery. This is part of a protocol developed by Apple that enables automatic discovery of computers, devices, and services on IP networks.
DSL	Digital Subscriber Line. A high-speed connection to the Internet.
Ethernet	The most common local network technology that connects computers using copper cabling.
Ethernet cable	The cable used to connect network elements in a wired network. The CAT-5 Ethernet cable is also known as a straight-through cable. When using an Ethernet cable, the network elements must be attached to a router. An Ethernet cable uses an RJ-45 connector.
EWS	Embedded Web Server. A browser-based utility that provides a simple way to manage the HP All-in-One. You can monitor status, configure HP All-in-One networking parameters, or access HP All-in-One features.
Gateway	A computer or other device, such as a router, that serves as an entrance to the Internet or another network.
HEX	Hexadecimal. The base 16 numbering system, which uses the digits 0-9 plus the letters A-F.
host computer	The computer at the center of a network.
Hostname	The TCP/IP name assigned by the installation software to the device. By default, this is the letters HP followed by the last 6 digits of the Media Access Control (MAC) address.
hub	No longer commonly used in modern home networks, a hub takes its signal from each computer and sends it to all of the other computers connected to

(continued)

	the hub. Hubs are passive; other devices on the network plug into the hub in order to communicate with one another. A hub does not manage the network.
IP address	A number that uniquely identifies the device on the network. IP addresses are assigned dynamically through DHCP or AutoIP. You can also set up a static IP address, though this is not recommended.
MAC address	Media Access Control (MAC) address that uniquely identifies the HP All-in-One. This is a unique 12-digit identification number assigned to networking hardware for identification. No two pieces of hardware have the same MAC address.
network name	The SSID or network name identifies a wireless network.
NIC	Network Interface Card. A card on your computer that provides an Ethernet connection so that you can connect your computer to a network.
RJ-45 connector	The connector on the ends of an Ethernet cable. Although standard Ethernet cable connectors (RJ-45 connectors) look similar to standard telephone cable connectors, they are not interchangeable. An RJ-45 connector is wider and thicker and always has 8 contacts on the end. A phone connector has between 2 and 6 contacts.
router	A router provides a bridge between two or more networks. A router can link a network to the Internet, link two networks and connect both to the Internet, and help secure networks through the use of firewalls and assigning dynamic addresses. A router can also act as a gateway, while a switch cannot.
SSID	The SSID or network name identifies a wireless network.
switch	A switch makes it possible for several users to send information over a network at the same time without slowing each other down. Switches allow different nodes (a network connection point, typically a computer) of a network to communicate directly with one another.
WEP	Wired Equivalent Privacy (WEP) is a type of encryption used for wireless network security.
WPA	Wi-Fi Protected Access (WPA) is a type of encryption used for wireless network security. WPA offers greater security than WEP.

5 How do I?

This section contains links to commonly performed tasks, such as printing photos, scanning, and making copies.

- [“How do I print 10 x 15 cm \(4 x 6\) inch borderless photos from a memory card?”](#) on page 67
- [“How do I make reprints of a photo in a variety of sizes?”](#) on page 79
- [“How do I make a black-and-white or color copy of a document?”](#) on page 85
- [“How do I print 13 x 18 cm \(5 x 7\) inch or larger size photos from a memory card?”](#) on page 67
- [“How do I save photos to my computer?”](#) on page 71
- [“How do I share my photos with family and friends?”](#) on page 70
- [“How do I scan a photo or document to the computer?”](#) on page 80
- [“How do I print on both sides of the paper?”](#) on page 55
- [“How do I print wide-rule notebook paper and graph paper for my child's homework project?”](#) on page 96

6 Load originals and load paper

You can load many different types and sizes of paper in the HP All-in-One, including letter or A4 paper, legal paper, photo paper, transparencies, envelopes, and HP CD/DVD tattoo labels. By default, the HP All-in-One is set to detect the size and type of paper you load in the input tray automatically and then adjust its settings to generate the highest quality output for that paper.

If you are using special papers, such as photo paper, transparency film, envelopes, or labels, or if you experience poor print quality using the automatically-adjusted settings, you can manually set the paper size and type for print and copy jobs.

This section contains the following topics:

- [Load originals](#)
- [Choose papers for printing and copying](#)
- [Load paper](#)
- [Avoid paper jams](#)

Load originals

You can copy or scan up to letter- or A4-size originals by loading them on the glass.



To load an original on the glass

1. Lift the lid on the HP All-in-One.
2. Load your original print side down on the right front corner of the glass.

 **TIP:** For more help on loading an original, refer to the engraved guides along the edge of the glass.

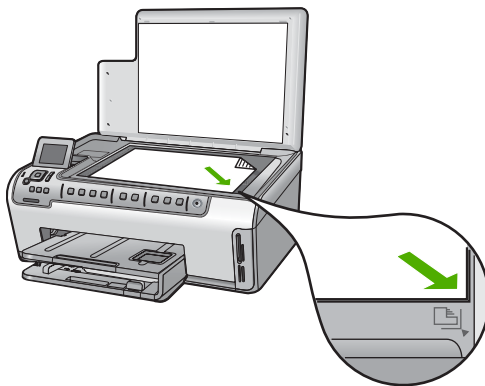

3. Close the lid.

Choose papers for printing and copying

You can use different types and sizes of paper in the HP All-in-One. Review the following recommendations to get the best printing and copying quality. Whenever you change paper types or sizes, remember to change those settings.

This section contains the following topics:

- [Recommended papers for printing and copying](#)
- [Recommended papers for printing only](#)
- [Papers to avoid](#)

Recommended papers for printing and copying

If you want the best print quality, HP recommends using HP papers that are specifically designed for the type of project you are printing. If you are printing photos, for example, load HP Premium or HP Premium Plus photo paper in the input tray.

HP Premium Plus Photo Paper

HP Premium Plus Photo Papers are the best HP photo paper, with image quality and fade resistance superior to store-processed photos. They are ideal for printing your high-resolution images for framing or including in a photo album. These papers are available in several sizes, including 10 x 15 cm (4 x 6 inch) (with or without tabs), A4, and 8.5 x 11 inch sizes for printing or copying photos from the HP All-in-One.

HP Premium Photo Paper

HP Premium Photo Papers are high-quality, glossy-finish or soft gloss-finish photo papers. They look and feel like store-processed photos and can be mounted under glass or in an album. These papers are available in several sizes, including 10 x 15 cm (4 x 6 inch) (with or without tabs), A4, and 8.5 x 11 inch sizes for printing or copying photos from the HP All-in-One.

HP Advanced Photo Paper or HP Photo Paper

HP Advanced Photo Paper or HP Photo Paper is a sturdy, glossy photo paper that features an instant-dry finish for easy handling without smudging. It resists water, smears, fingerprints, and humidity. Your prints have a look and feel comparable to a store-processed photo. It is available in several sizes, including A4, 8.5 x 11 inch, and 10 x 15 cm (4 x 6 inch) (with or without tabs) for printing or copying photos from the HP All-in-One. HP Advanced Photo Paper is marked on the nonprinting corners with the following symbol.



HP Premium Inkjet Transparency Film and HP Premium Plus Inkjet Transparency Film

HP Premium Inkjet Transparency Film and HP Premium Plus Inkjet Transparency Film make your color presentations vivid and even more impressive. This film is easy to use and handle and dries quickly without smudging.

HP Premium Inkjet Paper

HP Premium Inkjet Paper is the ultimate coated paper for high-resolution usage. A smooth, matte finish makes it ideal for your highest-quality documents.

HP Bright White Inkjet Paper

HP Bright White Inkjet Paper delivers high-contrast colors and sharp text. It is opaque enough for two-sided color usage with no show-through, which makes it ideal for newsletters, reports, and flyers.

HP All-in-One Paper or HP Printing Paper

- HP All-in-One Paper is specifically designed for HP All-in-One devices. It has an extra bright blue-white shade that produces sharper text and richer colors than ordinary multifunction papers.
- HP Printing Paper is a high-quality multifunction paper. It produces documents that look and feel more substantial than documents printed on standard multipurpose or copy paper.

To order genuine HP supplies for the HP All-in-One, go to www.hp.com/buy/supplies. If prompted, choose your country/region, follow the prompts to select your product, and then click one of the shopping links on the page.

Recommended papers for printing only

Certain papers are supported only when you start the print job from your computer. The following list provides information about these papers.

If you want the best print quality, HP recommends using HP papers. Using paper that is too thin or too thick, paper that has a slick texture, or paper that stretches easily can cause paper jams. Using paper that has a heavy texture or does not accept ink can cause printed images to smear, bleed, or not fill in completely.

Depending on your country/region, some of these papers might not be available.

HP Iron-On Transfers

HP Iron-On Transfers (for color fabrics or for light or white fabrics) are the ideal solution for creating custom T-shirts from your digital photos.

HP Premium Photo Cards

HP Premium Photo Cards enable you to make your own greeting cards.

HP Brochure & Flyer Paper

HP Brochure & Flyer Paper (Gloss or Matte) is glossy-coated or matte-coated on both sides for two-sided use. They are the perfect choice for near-photographic reproductions and business graphics for report covers, special presentations, brochures, mailers, and calendars.

HP Premium Presentation Paper

HP Premium Presentation Paper gives your presentation a quality look and feel.

HP CD/DVD Tattoos

HP CD/DVD Tattoos allow you to personalize your CDs and DVDs by printing high-quality, low-cost CD or DVD labels.

To order genuine HP supplies for the HP All-in-One, go to www.hp.com/buy/supplies. If prompted, choose your country/region, follow the prompts to select your product, and then click one of the shopping links on the page.

Papers to avoid

Using paper that is too thin or too thick, paper that has a slick texture, or paper that stretches easily can cause paper jams. Using paper that has a heavy texture or does not accept ink can cause printed images to smear, bleed, or not fill in completely.

Papers to avoid for all print and copy jobs

- Any size paper other than those listed in the HP All-in-One printer software.
- Paper with cutouts or perforations (unless specifically designed for use with HP inkjet devices).
- Highly textured stock, such as linen. It might not print evenly, and the ink can bleed into these papers.
- Extremely smooth, shiny, or coated papers not specifically designed for the HP All-in-One. They can jam the HP All-in-One or repel the ink.
- Multi-part forms, such as duplicate and triplicate forms. They can wrinkle or get stuck, and the ink is more likely to smear.
- Envelopes with clasps or windows. They can get stuck in the rollers and cause paper jams.
- Banner paper.

Additional papers to avoid when copying

- Envelopes.
- Transparency film other than HP Premium Inkjet Transparency Film or HP Premium Plus Inkjet Transparency Film.
- Iron-On Transfers.
- Greeting card paper.
- Inkjet labels.
- HP CD/DVD tattoo labels.

Load paper

This section describes the procedure for loading different types and sizes of paper into the HP All-in-One for your copies or printouts.

 **TIP:** To help prevent rips, wrinkles, and curled or bent edges, store all paper flat in a resealable bag. If the paper is not stored properly, extreme changes in temperature and humidity might result in curled paper that does not work well in the HP All-in-One.

This section contains the following topics:

- [Load full-size paper](#)
- [Load 10 x 15 cm \(4 x 6 inch\) photo paper](#)
- [Load postcards, Hagaki, or index cards](#)
- [Load envelopes](#)
- [Load other types of paper](#)

Load full-size paper

You can load many types of letter, A4, or legal paper into the main input tray of the HP All-in-One.



To load full-size paper

1. Pull out the main input tray, and then slide the paper-width and paper-length guides to their outermost positions.

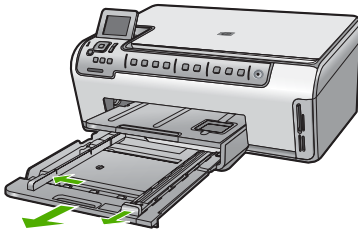

2. Tap a stack of paper on a flat surface to align the edges, and then check the paper for the following:
 - Make sure it is free of rips, dust, wrinkles, and curled or bent edges.
 - Make sure all the paper in the stack is the same size and type.
3. Insert the stack of paper into the main input tray with the short edge forward and the print side down. Slide the stack of paper forward until it stops.

 **TIP:** If you are using letterhead, insert the top of the page first with the print side down. For more help on loading full-size paper and letterhead, refer to the diagram engraved in the base of the input tray.

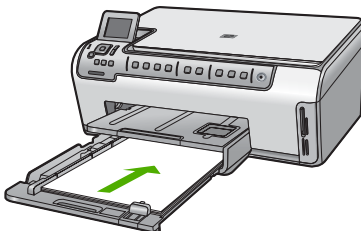

- Slide the paper-width and paper-length guides inward until they stop at the edges of the paper.
Do not overload the main input tray; make sure the stack of paper fits within the input tray and is no higher than the top of the paper-width guide.

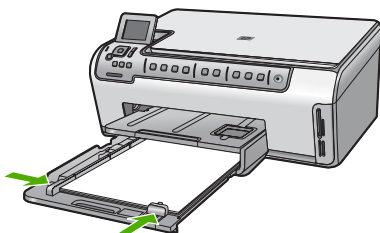

- Push the main input tray back into the HP All-in-One.
- Pull the output tray extender toward you, as far as it will go. Flip the paper catch at the end of the output tray extender to open the extender the rest of the way.

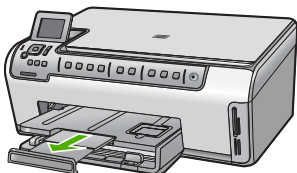

 **NOTE:** When you use legal-size paper, leave the tray extender closed.

Related topics

- [“Recommended papers for printing and copying” on page 34](#)
- [“Change the print settings for the current job” on page 46](#)

Load 10 x 15 cm (4 x 6 inch) photo paper

You can load up to 10 x 15 cm (4 x 6 inch) photo paper into the photo tray of the HP All-in-One. For the best results, use 10 x 15 cm (4 x 6 inch) HP Premium Plus Photo Paper or HP Premium Photo Paper.

To load 10 x 15 cm (4 x 6 inch) photo paper in the photo tray

- Raise the output tray, and then pull out the photo tray.

 **NOTE:** You can also remove the entire photo tray assembly to load photo paper into the photo tray.

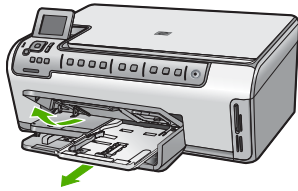

2. Insert the stack of photo paper into the photo tray with the short edge forward and the print side down. Slide the stack of photo paper forward until it stops.
If the photo paper you are using has perforated tabs, load the photo paper so that the tabs are closest to you.
3. Slide the paper-length and paper-width guides inward against the stack of photo paper until the guides stop.
Do not overload the photo tray; make sure the stack of photo paper fits within the photo tray and is no higher than the top of the paper-width guide.

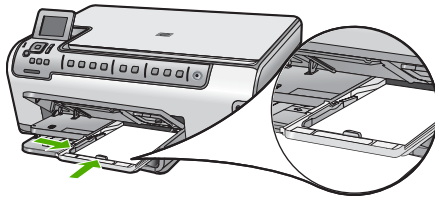

4. Push in the photo tray, and then lower the output tray.

Related topics

- [“Recommended papers for printing only”](#) on page 35
- [“Print your photos”](#) on page 67
- [“Print a borderless image”](#) on page 53
- [“Print a photo on photo paper”](#) on page 53

Load postcards, Hagaki, or index cards

You can load postcards, Hagaki, and index cards in the photo tray.

To load postcards, Hagaki, or index cards in the photo tray

1. Raise the output tray, and then pull out the photo tray.



NOTE: You can also remove the entire photo tray assembly to load cards into the photo tray.

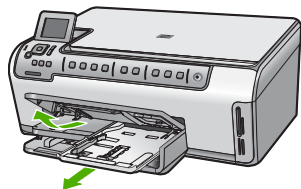

2. Insert the stack of cards into the photo tray with the short edge forward and the print side down. Slide the stack forward until it stops.
3. Slide the paper-length and paper-width guides inward against the stack of cards until the guides stop.

Do not overload the photo tray; make sure the stack of cards fits within the photo tray and is no higher than the top of the paper-width guide.

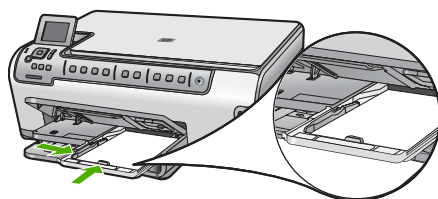

4. Push in the photo tray, and then lower the output tray.

Related topics

- [“Change the print settings for the current job”](#) on page 46
- [“Set the copy paper size”](#) on page 86

Load envelopes

You can load one or more envelopes into the main input tray of the HP All-in-One. Do not use shiny or embossed envelopes or envelopes that have clasps or windows.

 **NOTE:** For specific details on how to format text for printing on envelopes, consult the help files in your word processing software. For best results, consider using a label for the return address on envelopes.

To load envelopes

1. Pull out the main input tray, and then slide the paper-width and paper-length guides to their outermost positions.

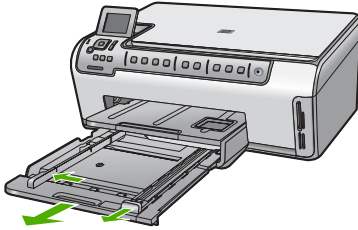

2. Remove all paper from the main input tray.
3. Insert one or more envelopes into the far-right side of the main input tray with the envelope flaps up and on the left. Slide the stack of envelopes forward until it stops.

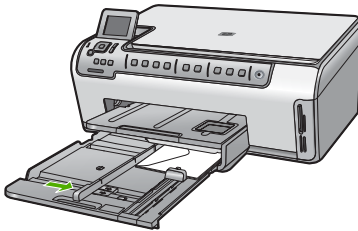

4. Slide the paper-width guide inward against the stack of envelopes until it stops. Do not overload the main input tray; make sure the stack of envelopes fits within the main input tray and is not higher than the top of the paper-width guide.
5. Push the main input tray back into the HP All-in-One.
6. Pull the output tray extender toward you, as far as it will go.

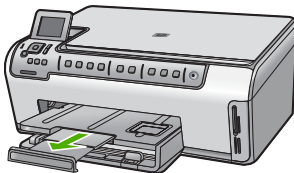

NOTE: When you use legal-size paper, leave the tray extender closed.

Related topics

[“Change the print settings for the current job” on page 46](#)

Load other types of paper

The following types of paper are designed for special projects. Create your project in the HP Photosmart Software or another application, set the paper type and size, and then print.

HP Premium Inkjet Transparency Film and HP Premium Plus Inkjet Transparency Film

- ▲ Insert the film so that the white transparency strip (with arrows and the HP logo) is on top and is going into the input tray first.



NOTE: For best results, set the paper type to transparency film before printing on transparency film.

HP Iron-On Transfers

1. Flatten the transfer sheet completely before using it; do not load curled sheets.



TIP: To prevent curling, keep transfer sheets sealed in the original package until you are ready to use them.

2. Locate the blue stripe on the nonprinting side of the transfer paper and then manually feed one sheet at a time into the input tray with the blue stripe facing up.

HP Greeting Cards, HP Photo Greeting Cards, or HP Textured Greeting Cards

- ▲ Insert a small stack of HP greeting card paper into the input tray with the print side down; slide the stack of cards forward until it stops.



TIP: Make sure the area on which you want to print is inserted first, print side down in the input tray.

Inkjet labels

1. Always use letter or A4 label sheets designed for use with inkjet devices, and make sure that the labels are no more than two years old. Labels on older sheets might peel off when the paper is pulled through the HP All-in-One, causing subsequent paper jams.
2. Fan the stack of labels to make sure none of the pages are sticking together.
3. Place a stack of label sheets on top of full-size plain paper in the input tray, label side down. Do not insert labels one sheet at a time.

For best results, set the paper type and paper size before printing.

HP CD/DVD Tattoo labels

- ▲ Place one sheet of CD/DVD tattoo paper in the input tray with the print side down; slide the CD/DVD tattoo paper forward until it stops.



NOTE: When you use CD/DVD tattoo labels, leave the tray extender closed.

Related topics

- [“Change the print settings for the current job”](#) on page 46
- [“Recommended papers for printing only”](#) on page 35

Avoid paper jams

To help avoid paper jams, follow these guidelines.

- Remove printed papers from the output tray frequently.
- Prevent curled or wrinkled paper by storing all unused paper flat in a resealable bag.
- Ensure that paper loaded in the input tray lays flat and the edges are not bent or torn.
- If you are printing labels, ensure that the label sheets are no more than two years old. Labels on older sheets might peel off when the paper is pulled through the HP All-in-One, and cause paper jams.
- Do not combine different paper types and paper sizes in the input tray; the entire stack of paper in the input tray must be the same size and type.
- Adjust the paper-width guide in the input tray to fit snugly against all paper. Make sure the paper-width guide does not bend the paper in the input tray.
- Do not force paper too far forward in the input tray.
- Use paper types that are recommended for the HP All-in-One.

Related topics

- [“Recommended papers for printing and copying”](#) on page 34
- [“Papers to avoid”](#) on page 36
- [“Clear paper jams”](#) on page 111

7 Print from your computer

The HP All-in-One can be used with any software application that allows printing. You can print a range of projects, such as borderless images, newsletters, greeting cards, iron-on transfers, and posters.

You can also automatically print on both sides of the page using the Two-sided printing accessory included with the HP All-in-One to print brochures and booklets, or just save paper.

This section contains the following topics:

- [Print from a software application](#)
- [Make the HP All-in-One the default printer](#)
- [Change the print settings for the current job](#)
- [Change the default print settings](#)
- [Printing shortcuts](#)
- [Perform special print jobs](#)
- [Stop a print job](#)

Print from a software application

Most print settings are automatically handled by the software application. You need to change the settings manually only when you change print quality, print on specific types of paper or transparency film, or use special features.

To print from a software application

1. Make sure you have paper loaded in the input tray.
2. On the **File** menu in your software application, click **Print**.
3. Select the HP All-in-One as the printer.
If you set the HP All-in-One as the default printer, you can skip this step. The HP All-in-One will already be selected.
4. If you need to change settings, click the button that opens the **Properties** dialog box. Depending on your software application, this button might be called **Properties**, **Options**, **Printer Setup**, **Printer**, or **Preferences**.



NOTE: When printing a photo, you must select options for the specific photo paper and photo enhancement.

5. Select the appropriate options for your print job by using the features available in the **Advanced**, **Printing Shortcuts**, **Features**, and **Color** tabs.

 **TIP:** You can easily select the appropriate options for your print job by choosing one of the predefined print tasks on the **Printing Shortcuts** tab. Click a type of print task in the **Printing Shortcuts** list. The default settings for that type of print task are set and summarized on the **Printing Shortcuts** tab. If necessary, you can adjust the settings here and save your custom settings as a new printing shortcut. To save a custom printing shortcut, select the shortcut and click **Save As**. To delete a shortcut, select the shortcut and click **Delete**.

6. Click **OK** to close the **Properties** dialog box.
7. Click **Print** or **OK** to begin printing.

Make the HP All-in-One the default printer

You can set the HP All-in-One as the default printer to use from all software applications. This means that the HP All-in-One is automatically selected in the printer list when you select **Print** from the **File** menu in a software application. The default printer is automatically selected when you click the **Print** button in the toolbar of most software applications. For more information, see the Windows Help.

Change the print settings for the current job

You can customize the print settings of the HP All-in-One to handle nearly any print task.

This section contains the following topics:

- [Set the paper size](#)
- [Set the paper type for printing](#)
- [View the print resolution](#)
- [Change the print speed or quality](#)
- [Change the page orientation](#)
- [Scale the document size](#)
- [Change the saturation, brightness, or color tone](#)
- [Preview your print job](#)

Set the paper size

The **Size** setting helps the HP All-in-One determine the printable area on the page. Some of the paper size choices have a borderless equivalent, which allows you to print to the top, bottom, and side edges of the paper.

Usually, you set the paper size in the software application you used to create your document or project. However, if you are using custom-size paper, or if you cannot set the paper size from your software application, you can change the paper size in the **Properties** dialog box before printing.

To set the paper size

1. Make sure you have paper loaded in the input tray.
2. On the **File** menu in your software application, click **Print**.
3. Make sure the HP All-in-One is the selected printer.
4. Click the button that opens the **Properties** dialog box.
Depending on your software application, this button might be called **Properties**, **Options**, **Printer Setup**, **Printer**, or **Preferences**.
5. Click the **Features** tab.
6. In the **Resizing Options** area, from the **Size** drop-down list, select **More**.
7. Select the appropriate paper size, and then click **OK**.

The following table lists the suggested paper size settings for the different types of paper you can load in the input tray. Make sure to look at the long list of choices in the **Size** list to see if a defined paper size already exists for the type of paper you are using.

Paper type	Suggested paper size settings
CD/DVD tattoo paper	5 x 7 in.
Copier, multi-purpose, or plain papers	Letter or A4
Envelopes	Appropriate listed envelope size
Greeting-card papers	Letter or A4
Index cards	Appropriate listed card size (if listed sizes are not appropriate, you can specify a custom paper size)
Inkjet papers	Letter or A4
Iron-on T-shirt transfers	Letter or A4
Labels	Letter or A4
Legal	Legal
Letterhead	Letter or A4
Panorama photo paper	Appropriate listed panorama size (if listed sizes are not appropriate, you can specify a custom paper size)
Photo papers	10 x 15 cm. (with or without tab), 4 x 6 in. (with or without tab), letter, A4, or appropriate listed size
Transparency films	Letter or A4
Custom-size papers	Custom paper size

Set the paper type for printing

If you print on special papers, such as photo paper, transparency film, envelopes, or labels, or if you experience poor print quality, you can set the paper type manually.

To set the paper type for printing

1. Make sure you have paper loaded in the input tray.
2. On the **File** menu in your software application, click **Print**.
3. Make sure the HP All-in-One is the selected printer.
4. Click the button that opens the **Properties** dialog box.
Depending on your software application, this button might be called **Properties**, **Options**, **Printer Setup**, **Printer**, or **Preferences**.
5. Click the **Features** tab.
6. In the **Basic Options** area, from the **Paper Type** drop-down list, select **More**.
7. Select the type of paper that you have loaded, and then click **OK**.

View the print resolution

The printer software displays the print resolution in dots per inch (dpi). The dpi varies according to the paper type and print quality that you select in the printer software.

To view the print resolution

1. Make sure you have paper loaded in the input tray.
2. On the **File** menu in your software application, click **Print**.
3. Make sure the HP All-in-One is the selected printer.
4. Click the button that opens the **Properties** dialog box.
Depending on your software application, this button might be called **Properties**, **Options**, **Printer Setup**, **Printer**, or **Preferences**.
5. Click the **Features** tab.
6. In the **Print Quality** drop-down list, select the appropriate print quality setting for your project.
7. In the **Paper Type** drop-down list, select the type of paper that you have loaded.
8. Click the **Resolution** button to view the print resolution dpi.

Change the print speed or quality

The HP All-in-One automatically chooses a print quality and speed setting depending on the paper type setting you select. You can also change the print quality setting to customize the speed and quality of the print process.

To select a print speed or quality

1. Make sure you have paper loaded in the input tray.
2. On the **File** menu in your software application, click **Print**.
3. Make sure the HP All-in-One is the selected printer.
4. Click the button that opens the **Properties** dialog box.
Depending on your software application, this button might be called **Properties**, **Options**, **Printer Setup**, **Printer**, or **Preferences**.
5. Click the **Features** tab.

6. In the **Print Quality** drop-down list, select the appropriate quality setting for your project.



NOTE: To view the maximum dpi that the HP All-in-One will print, click **Resolution**.

7. In the **Paper Type** drop-down list, select the type of paper that you have loaded.

Change the page orientation

The page orientation setting allows you to print your document vertically or horizontally on the page.

Usually, you set the page orientation in the software application you used to create your document or project. However, if you are using custom-size or special HP paper, or if you cannot set the page orientation from your software application, you can change the page orientation in the **Properties** dialog box before printing.

To change the page orientation

1. Make sure you have paper loaded in the input tray.
2. On the **File** menu in your software application, click **Print**.
3. Make sure the HP All-in-One is the selected printer.
4. Click the button that opens the **Properties** dialog box.
Depending on your software application, this button might be called **Properties**, **Options**, **Printer Setup**, **Printer**, or **Preferences**.
5. Click the **Features** tab.
6. In the **Basic Options** area, click one of the following:
 - Click **Portrait** to print the document vertically on the page.
 - Click **Landscape** to print the document horizontally on the page.

Scale the document size

The HP All-in-One allows you to print the document at a different size than the original.

To scale the document size

1. Make sure you have paper loaded in the input tray.
2. On the **File** menu in your software application, click **Print**.
3. Make sure the HP All-in-One is the selected printer.
4. Click the button that opens the **Properties** dialog box.
Depending on your software application, this button might be called **Properties**, **Options**, **Printer Setup**, **Printer**, or **Preferences**.
5. Click the **Features** tab.
6. In the **Resizing options** area, click **Scale to paper size**, and then click the appropriate paper size from the drop-down list.

Change the saturation, brightness, or color tone

You can change the intensity of colors and the level of darkness in your printout by adjusting the **Saturation**, **Brightness**, or **Color Tone** options.

To change the saturation, brightness, or color tone

1. Make sure you have paper loaded in the input tray.
2. On the **File** menu in your software application, click **Print**.
3. Make sure the HP All-in-One is the selected printer.
4. Click the button that opens the **Properties** dialog box.
Depending on your software application, this button might be called **Properties**, **Options**, **Printer Setup**, **Printer**, or **Preferences**.
5. Click the **Color** tab.
6. Click the **Advanced Color Settings** button.
7. Move the sliders to adjust the **Saturation**, **Brightness**, or **Color Tone**.
 - **Brightness** indicates the lightness or darkness of the printed document.
 - **Saturation** is the relative purity of printed colors.
 - **Color Tone** affects the perceived warmth or coolness of printed colors, by adding more orange or blue tones, respectively, to your image.

Preview your print job

You can preview your print job before sending it to the HP All-in-One. This helps to prevent wasting paper and ink on projects that do not print as expected.

To preview your print job

1. Make sure you have paper loaded in the input tray.
2. On the **File** menu in your software application, click **Print**.
3. Make sure the HP All-in-One is the selected printer.
4. Click the button that opens the **Properties** dialog box.
Depending on your software application, this button might be called **Properties**, **Options**, **Printer Setup**, **Printer**, or **Preferences**.
5. Select the print settings appropriate for your project on each of the tabs in the dialog box.
6. Click the **Features** tab.
7. Select the **Show Preview Before Printing** check box.
8. Click **OK**, and then click **Print** or **OK** in the **Print** dialog box.
Your print job displays in the preview window.
9. In the **HP preview** window, do one of the following:
 - To print, click **Start Printing**.
 - To cancel, click **Cancel Printing**.

Change the default print settings

If there are settings that you frequently use for printing, you might want to make them the default print settings so they are already set when you open the **Print** dialog box from within your software application.

To change the default print settings

1. In the HP Solution Center, click **Settings**, point to **Print Settings**, and then click **Printer Settings**.
2. Make changes to the print settings, and click **OK**.

Printing shortcuts

Use printing shortcuts to print with print settings that you use often. The printer software has several specially designed printing shortcuts that are available in the Printing Shortcuts list.

 **NOTE:** When you select a printing shortcut the appropriate printing options are automatically displayed. You can leave them as is, change them, or create your own shortcuts for commonly used tasks.

Use the Printing Shortcuts tab for the following print tasks:

- **General Everyday Printing:** Print documents quickly.
- **Photo Printing–Borderless:** Print to the top, bottom, and side edges of 10 x 15 cm (4 x 6 inch) HP Photo Papers with or without a tear-off tab.
- **Photo Printing–With White Borders:** Print a photo with a white border around the edges.
- **Fast/Economical printing:** Produce draft-quality printouts quickly.
- **Presentation printing:** Print high-quality documents, including letters and transparencies.
- **Two-sided (Duplex) Printing:** Print two-sided pages with the HP All-in-One.

This section contains the following topics:

- [Create printing shortcuts](#)
- [Delete printing shortcuts](#)

Related topics

- [“Print a borderless image” on page 53](#)
- [“Print a photo on photo paper” on page 53](#)
- [“Print on transparencies” on page 59](#)
- [“Print on both sides of the page” on page 55](#)

Create printing shortcuts

In addition to the printing shortcuts that are available in the **Printing Shortcuts** list, you can create your own printing shortcuts.

If you frequently print on transparency film, for example, you can create a printing shortcut by selecting the **Presentation Printing** shortcut, changing the paper type to **HP Premium Inkjet Transparency Film**, and then saving the modified shortcut under a new name; for example, **Transparency Presentations**. After creating the printing shortcut, simply select it when printing on transparency film rather than changing the print settings each time.

To create a printing shortcut

1. On the **File** menu in your software application, click **Print**.
2. Make sure the HP All-in-One is the selected printer.
3. Click the button that opens the **Properties** dialog box.
Depending on your software application, this button might be called **Properties**, **Options**, **Printer Setup**, **Printer**, or **Preferences**.
4. Click the **Printing Shortcuts** tab.
5. In the **Printing Shortcuts** list, click a printing shortcut.
The print settings for the selected printing shortcut are displayed.
6. Change the print settings to those you want in the new printing shortcut.
7. Click **Save as** and type a name for the new printing shortcut, and then click **Save**.
The printing shortcut is added to the list.

Delete printing shortcuts

You might want to delete printing shortcuts that you no longer use.

To delete a printing shortcut

1. On the **File** menu in your software application, click **Print**.
2. Make sure the HP All-in-One is the selected printer.
3. Click the button that opens the **Properties** dialog box.
Depending on your software application, this button might be called **Properties**, **Options**, **Printer Setup**, **Printer**, or **Preferences**.
4. Click the **Printing Shortcuts** tab.
5. In the **Printing Shortcuts** list, click the printing shortcut that you want to delete.
6. Click **Delete**.
The printing shortcut is removed from the list.



NOTE: Only the shortcuts that you have created can be deleted. The original HP shortcuts cannot be deleted.

Perform special print jobs

In addition to supporting standard print jobs, the HP All-in-One can perform special jobs such as printing borderless images, iron-on transfers, and posters.

This section contains the following topics:

- [Print a borderless image](#)
- [Print a photo on photo paper](#)
- [Print custom CD/DVD labels](#)
- [Print using Maximum dpi](#)
- [Print on both sides of the page](#)
- [Print a multiple-page document as a booklet](#)
- [Print multiple pages on a single sheet](#)
- [Print a multiple-page document in reverse order](#)
- [Reverse an image for iron-on transfers](#)

- [Print on transparencies](#)
- [Print a group of addresses on labels or envelopes](#)
- [Print a poster](#)
- [Print a Web page](#)

Print a borderless image

Borderless printing lets you print to the top, bottom, and side edges of 10 x 15 cm (4 x 6 inch) photo paper.

 **TIP:** For the best results, use HP Premium Photo Papers or HP Premium Plus Photo Papers to print your photos.

To print a borderless image

1. Load up to 10 x 15 cm (4 x 6 inch) paper in the photo tray.
2. On the **File** menu in your software application, click **Print**.
3. Make sure the HP All-in-One is the selected printer.
4. Click the button that opens the **Properties** dialog box.
Depending on your software application, this button might be called **Properties**, **Options**, **Printer Setup**, **Printer**, or **Preferences**.
5. Click the **Features** tab.
6. In the **Size** list, click **More**, and then select the size of photo paper loaded in the photo tray.
If a borderless image can be printed on the specified size, the **Borderless printing** check box is enabled.
7. In the **Paper Type** drop-down list, click **More**, and then select the appropriate paper type.

 **NOTE:** You cannot print a borderless image if the paper type is set to **Plain paper** or to a type of paper other than a photo paper.

8. Select the **Borderless** check box if it is not already checked.
If the borderless paper size and paper type are not compatible, the HP All-in-One software displays an alert and allows you to select a different type or size.
9. Click **OK**, and then click **Print** or **OK** in the **Print** dialog box.

Print a photo on photo paper

For high-quality photo printing, HP recommends you use HP Premium Plus Photo Papers with the HP All-in-One.

To print a photo on photo paper

1. Load up to 10 x 15 cm (4 x 6 inch) paper in the photo tray or full-size photo paper in the main input tray.
2. On the **File** menu in your software application, click **Print**.
3. Make sure the HP All-in-One is the selected printer.

4. Click the button that opens the **Properties** dialog box.
Depending on your software application, this button might be called **Properties**, **Options**, **Printer Setup**, **Printer**, or **Preferences**.
5. Click the **Features** tab.
6. In the **Basic Options** area, from the **Paper Type** drop-down list, select **More**. Then, select the appropriate photo paper type.
7. In the **Resizing Options** area, from the **Size** drop-down list, select **More**. Then, select the appropriate paper size.
If the paper size and paper type are not compatible, the HP All-in-One software displays an alert and allows you to select a different type or size.
8. In the **Basic Options** area, select a high print quality, such as **Best** or **Maximum dpi** from the **Print Quality** drop-down list.
9. In the **HP Real Life Technologies (RTL)** area, click the **Photo fix** drop-down list and select from the following options:
 - **Off**: applies no **HP Real Life technologies** to the image.
 - **Basic**: automatically focuses the image; moderately adjusts image sharpness.
 - **Full**: automatically lightens dark images; automatically adjusts sharpness, contrast, and focus of images; automatically removes red-eye.
10. Click **OK** to return to the **Properties** dialog box.
11. If you want to print the photo in black and white, click the **Color** tab and select the **Print in grayscale** check box.
12. Click **OK**, and then click **Print** or **OK** in the **Print** dialog box.

 **NOTE:** Do not leave unused photo paper in the input tray. The paper might start to curl, which could reduce the quality of your printout. Photo paper should be flat before printing.

Print custom CD/DVD labels

You can use the HP Photosmart Software or online templates from the HP Web site to create and print a custom label on CD/DVD tattoo paper. You can affix the printed CD/DVD tattoo to any CD/DVD.

To print a CD/DVD tattoo

1. Use the HP Photosmart Software, or go to www.hp.com to access templates for creating CD/DVD labels.
2. Load 13 x 18 cm (5 x 7 inch) CD/DVD tattoo paper in the main input tray.
3. On the **File** menu in your software application, click **Print**.
4. Make sure the HP All-in-One is the selected printer.
5. Click the button that opens the **Properties** dialog box.
Depending on your software application, this button might be called **Properties**, **Options**, **Printer Setup**, **Printer**, or **Preferences**.
6. Click the **Features** tab.
7. In the **Paper Type** drop-down list, click **More**, and then select **HP CD/DVD tattoo paper** from the list.
8. Click **OK**, and then click **Print** or **OK** in the **Print** dialog box.

Print using Maximum dpi

Use **Maximum dpi** mode to print high-quality, sharp images.

To get the most benefit from **Maximum dpi** mode, use it to print high-quality images such as digital photographs. When you select the **Maximum dpi** setting, the printer software displays the optimized dots per inch (dpi) that the HP All-in-One will print.

Printing in **Maximum dpi** takes longer than printing with other settings and requires a large amount of disk space.

To print in Maximum dpi mode

1. Load up to 10 x 15 cm (4 x 6 inch) paper in the photo tray or full-size photo paper in the main input tray.
2. On the **File** menu in your software application, click **Print**.
3. Make sure the HP All-in-One is the selected printer.
4. Click the button that opens the **Properties** dialog box.
Depending on your software application, this button might be called **Properties**, **Options**, **Printer Setup**, **Printer**, or **Preferences**.
5. Click the **Features** tab.
6. In the **Paper Type** drop-down list, click **More**, and then select the appropriate paper type.
7. In the **Print Quality** drop-down list, click **Maximum dpi**.



NOTE: To view the maximum dpi that the HP All-in-One will print, click **Resolution**.

8. Select any other print settings that you want, and then click **OK**.

Print on both sides of the page

You can print on both sides of the page using the Two-sided printing accessory included with the HP All-in-One to print brochures and booklets, or just save paper.

When printing two-sided pages, make sure to use paper that is thick enough so that images do not show through to the other side. HP recommends using high-quality paper such as HP Bright White Inkjet Paper or HP Brochure & Flyer Paper.

To print on both sides of the page

1. Load paper into the input tray.
2. On the **File** menu in your software application, click **Print**.
3. Make sure the HP All-in-One is the selected printer.
4. Click the button that opens the **Properties** dialog box.
Depending on your software application, this button might be called **Properties**, **Options**, **Printer Setup**, **Printer**, or **Preferences**.
5. Click the **Features** tab.
6. In the **Paper saving options** area, from the **Two-sided printing** drop-down list, select either **On** or **Automatic** depending on your software.
7. Click **OK**, and then click **Print** or **OK** in the **Print** dialog box.

Print a multiple-page document as a booklet

The HP All-in-One allows you to print your document as a small booklet, which you can fold and then staple together.

For best results, design your document to fit on a multiple of four pages, such as an 8, 12, or 16-page program for a child's school play or for a wedding.

To print a multiple-page document as a booklet

1. Load paper into the input tray.
The paper should be thick enough so that the images do not show through to the other side.
2. On the **File** menu in your software application, click **Print**.
3. Make sure the HP All-in-One is the selected printer.
4. Click the button that opens the **Properties** dialog box.
Depending on your software application, this button might be called **Properties**, **Options**, **Printer Setup**, **Printer**, or **Preferences**.
5. Click the **Features** tab.
6. In the **Paper saving options** area, from the **Two-sided printing** drop-down list, select either **On** or **Automatic** depending on your software.
7. Select the binding edge from the **Booklet layout** list, as appropriate for your language.
 - If your language reads left-to-right, click **Left edge binding**.
 - If your language reads right-to-left, click **Right edge binding**.
 The **Pages per sheet** box is automatically set to two pages per sheet.
8. Click **OK**, and then click **Print** or **OK** in the **Print** dialog box.
The HP All-in-One begins printing.
9. Wait until the HP All-in-One has stopped printing for several seconds before removing any of the printed pages from the output tray.
If you remove the pages while the document is still printing, the pages might get out of order.
10. When the entire document has finished printing, fold the stack of paper in half, so that the first page is on top, then staple the document along the crease.

 **TIP:** For best results, use a saddle stapler, or a heavy-duty stapler with a long reach to staple the booklet.

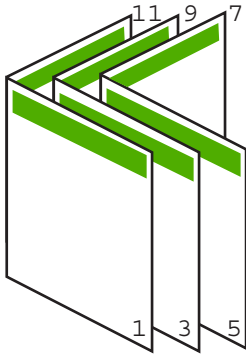

Figure 7-1 Left-edge binding for left-to-right languages

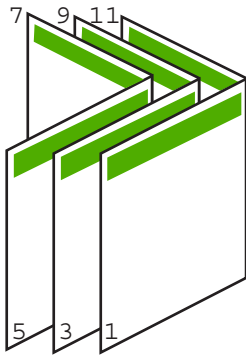

Figure 7-2 Right-edge binding for right-to-left languages

Print multiple pages on a single sheet

You can print up to 16 pages on a single sheet of paper.

To print multiple pages on a single sheet

1. Make sure you have paper loaded in the input tray.
2. On the **File** menu in your software application, click **Print**.
3. Make sure the HP All-in-One is the selected printer.
4. Click the button that opens the **Properties** dialog box.
Depending on your software application, this button might be called **Properties**, **Options**, **Printer Setup**, **Printer**, or **Preferences**.
5. Click the **Features** tab.
6. In the **Pages per sheet** list, click **2**, **4**, **6**, **8**, **9**, or **16**.
7. If you want a border to appear around each page image printed on the sheet of paper, select the **Print page borders** check box.

8. In the **Page order** list, click an appropriate page order option.
The sample output graphic is numbered to show how the pages will be ordered if you select each option.
9. Click **OK**, and then click **Print** or **OK** in the **Print** dialog box.

Print a multiple-page document in reverse order

Because of the way the paper feeds through the HP All-in-One, the first page that prints is print side up at the bottom of the stack. Usually this means you need to put the printed pages in the correct order.

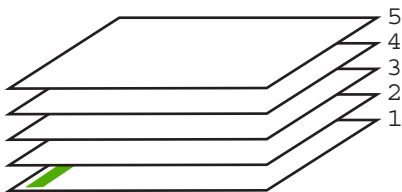

A better way is to print the document in reverse order so that the pages are stacked correctly.

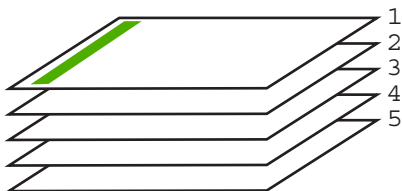

 **TIP:** Set this option as a default setting so you do not have to remember to set it every time you print a multiple-page document.

To print a multiple-page document in reverse order

1. Make sure you have paper loaded in the input tray.
2. On the **File** menu in your software application, click **Print**.
3. Make sure the HP All-in-One is the selected printer.
4. Click the button that opens the **Properties** dialog box.
Depending on your software application, this button might be called **Properties**, **Options**, **Printer Setup**, **Printer**, or **Preferences**.
5. Click the **Advanced** tab.

6. In the **Layout Options** area, select **Front to Back** in the **Page Order** option.

 **NOTE:** If you set your document to print on both sides of the page, the **Front to Back** option is not available. Your document will automatically print in the correct order.

7. Click **OK**, and then click **Print** or **OK** in the **Print** dialog box.

 **NOTE:** When you are printing multiple copies, each set is printed completely before the next set is printed.

Reverse an image for iron-on transfers

This feature reverses an image so you can use it for iron-on transfers. This feature is also useful for transparencies when you want to make notations on the back of the transparency without scratching the original.

To reverse an image for iron-on transfers

1. On the **File** menu in your software application, click **Print**.
2. Make sure the HP All-in-One is the selected printer.
3. Click the button that opens the **Properties** dialog box.
Depending on your software application, this button might be called **Properties**, **Options**, **Printer Setup**, **Printer**, or **Preferences**.
4. Click the **Features** tab.
5. In the **Paper Type** drop-down list, click **More**, and then select **HP Iron-on Transfer** from the list.
6. If the selected size is not what you want, click an appropriate size in the **Size** list.
7. Click the **Advanced** tab.
8. In the **Printer Features** area, select **On** from the **Mirror Image** drop-down list.
9. Click **OK**, and then click **Print** or **OK** in the **Print** dialog box.

 **NOTE:** To prevent jams, manually feed the iron-on transfer sheets into the input tray one sheet at a time.

Print on transparencies

For the best results, HP recommends you use HP transparency products with the HP All-in-One.

To print on transparencies

1. Load the transparency into the input tray.
2. On the **File** menu in your software application, click **Print**.
3. Make sure the HP All-in-One is the selected printer.
4. Click the button that opens the **Properties** dialog box.
Depending on your software application, this button might be called **Properties**, **Options**, **Printer Setup**, **Printer**, or **Preferences**.
5. Click the **Features** tab.

6. In the **Basic Options** area, from the **Paper Type** drop-down list, select **More**. Then select the appropriate paper type.

 **TIP:** If you want to make notations on the back of the transparencies and erase them later without scratching the original, click the **Advanced** tab, and select the **Mirror Image** check box.

7. In the **Resizing Options** area, from the **Size** drop-down list, select **More**. Then, select an appropriate size.
8. Click **OK**, and then click **Print** or **OK** in the **Print** dialog box.

 **NOTE:** The HP All-in-One automatically waits for transparencies to dry before releasing them. Ink dries slower on film than on plain paper. Make sure you allow enough time for the ink to dry before handling the transparency.

Print a group of addresses on labels or envelopes

With the HP All-in-One, you can print on a single envelope, a group of envelopes, or label sheets designed for inkjet printers.

To print a group of addresses on labels or envelopes

1. Print a test page on plain paper first.
 2. Place the test page on top of the label sheet or envelope, and hold both up to the light. Check the spacing for each block of text. Make adjustments as needed.
 3. Load the labels or envelopes into the main input tray.
-
-  **CAUTION:** Do not use envelopes with clasps or windows. They can get stuck in the rollers and cause paper jams.
-
4. Slide the paper-length and paper-width guides inward against the stack of labels or envelopes until the guides stop.
 5. If you are printing on envelopes, do the following:
 - a. Display the print settings, and click the **Features** tab.
 - b. In the **Resizing Options** area, click the appropriate envelope size in the **Size** list.
 6. Click **OK**, and then click **Print** or **OK** in the **Print** dialog box.

Print a poster

You can create a poster by printing a document on multiple pages. The HP All-in-One prints dotted lines on some pages to indicate where to trim the pages before taping them together.



To print a poster

1. Make sure you have paper loaded in the input tray.
2. On the **File** menu in your software application, click **Print**.
3. Make sure the HP All-in-One is the selected printer.
4. Click the button that opens the **Properties** dialog box.
Depending on your software application, this button might be called **Properties**, **Options**, **Printer Setup**, **Printer**, or **Preferences**.
5. Click the **Advanced** tab.
6. Expand **Document Options**, and then expand **Printer Features**.
7. In the **Poster Printing** drop-down list, click either **2x2 (4 sheets)**, **3x3 (9 sheets)**, **4x4 (16 sheets)**, or **5x5 (25 sheets)**.
This selection tells the HP All-in-One to enlarge your document so that it fits on 4, 9, 16, or 25 pages.
If your originals are of multiple pages, each of those pages will be printed on 4, 9, 16, or 25 pages. For example, if you have a one-page original and you select 3x3, you will get 9 pages; if you select 3x3 for a two-page original, 18 pages will print.
8. Click **OK**, and then click **Print** or **OK** in the **Print** dialog box.
9. After the poster has printed, trim the edges of the sheets and tape the sheets together.

Print a Web page

You can print a Web page from your Web browser on the HP All-in-One.

If you use Internet Explorer 6.0 or higher for Web browsing, you can use **HP Smart Web Printing** to ensure simple, predictable web printing with control over what you want and how you want it printed. You can access **HP Smart Web Printing** from the toolbar in Internet Explorer. For more information about **HP Smart Web Printing**, see the help file provided with it.

To print a Web page

1. Make sure you have paper loaded in the main input tray.
2. On the **File** menu in your Web browser, click **Print**.
The **Print** dialog box appears.
3. Make sure the HP All-in-One is the selected printer.
4. If your Web browser supports it, select the items on the Web page that you want to include in the printout.
For example, in Internet Explorer, click the **Options** tab to select options such as **As laid out on screen**, **Only the selected frame**, and **Print all linked documents**.
5. Click **Print** or **OK** to print the Web page.

 **TIP:** To print Web pages correctly, you might need to set your print orientation to **Landscape**.

Stop a print job

Although you can stop a print job from either the HP All-in-One or the computer, HP recommends you stop it from the HP All-in-One for best results.

 **NOTE:** Although most software applications designed for Windows use the Windows print spooler, your software application might not use the spooler. An example of a software application that does not use the Windows print spooler is PowerPoint in Microsoft Office 97.

If you cannot cancel your print job by using one of the following procedures, consult the instructions for canceling background printing in the online help for your software application.

To stop a print job from the HP All-in-One

- ▲ Press **Cancel** on the control panel. If the print job does not stop, press **Cancel** again. It can take a few moments for the print job to be cancelled.

To stop a print job from the computer (Windows 2000 users)

1. On the Windows taskbar, click **Start**, point to **Settings**, and then click **Printers**.
2. Double-click the HP All-in-One icon.

 **TIP:** You can also double-click the printer icon in the Windows taskbar.

3. Select the print job you want to cancel.
4. On the **Document** menu, click **Cancel Printing** or **Cancel**, or press the **Delete** key on your keyboard.
It can take a few moments for the print job to be cancelled.

To stop a print job from the computer (Windows XP users)

1. On the Windows taskbar, click **Start**, and then click **Control Panel**.
2. Open the **Printers and Faxes** control panel.

3. Double-click the HP All-in-One icon.

 **TIP:** You can also double-click the printer icon in the Windows taskbar.

4. Select the print job you want to cancel.
5. On the **Document** menu, click **Cancel Printing** or **Cancel**, or press the **Delete** key on your keyboard.
It can take a few moments for the print job to be cancelled.

To stop a print job from the computer (Windows Vista users)

1. On the Windows taskbar, click **Start**, and then click **Control Panel**.
2. Click **Printers**.
3. Double-click the HP All-in-One icon.

 **TIP:** You can also double-click the printer icon in the Windows taskbar.

4. Select the print job you want to cancel.
5. On the **Document** menu, click **Cancel Printing** or **Cancel**, or press the **Delete** key on your keyboard.
It can take a few moments for the print job to be cancelled.

8 Use the photo features

The HP All-in-One is equipped with memory card slots that enable you to print or edit photos from a memory card without uploading your photos to a computer first. Additionally, if the HP All-in-One is network-connected or connected to a computer with a USB cable, you can also transfer your photos to the computer to print, edit, or share. The HP All-in-One supports the memory cards described below. Each type of memory card can only be inserted in the appropriate slot for that card, and only one card may be inserted at a time.

△ **CAUTION:** Do not insert more than one memory card at a time. If more than one memory card is inserted, unrecoverable data loss might occur.

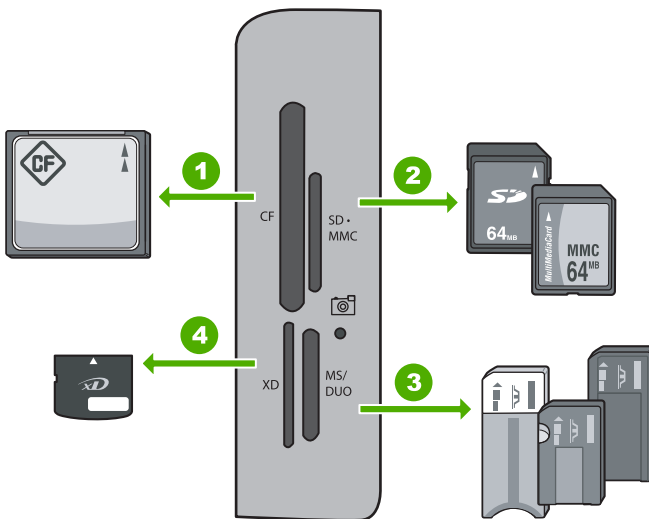

1	CompactFlash (CF) types I and II
2	Secure Digital (SD), Secure Digital Mini (adapter required), Secure Digital High Capacity (SDHC), MultiMediaCard (MMC), MMC Plus, MMC Mobile (RS-MMC; adapter required), TransFlash MicroSD Card, or Secure MultiMedia Card
3	Memory Stick, Memory Stick Pro, Memory Stick Select, Memory Stick Magic Gate, Memory Stick Duo or Duo Pro (adapter optional), or Memory Stick Micro (adapter required)
4	xD-Picture Card

The memory card area also has a Photo light. This light blinks green when a memory card is being read or when an image is being printed from a card, and stays solid green

when images are ready to be viewed. The Photo light is located near the memory card slots and is indicated by a camera icon.

△ **CAUTION:** Do not pull out the memory card while the Photo light is flashing. A flashing light means the HP All-in-One is accessing the memory card. Wait until the light remains solid. Removing a memory card while it is being accessed might corrupt information on the card or damage the HP All-in-One or memory card.

This section contains the following topics:

- [View and select photos](#)
- [Print your photos](#)
- [Create special projects from your photos](#)
- [Share photos using HP Photosmart Software](#)
- [Save photos to your computer](#)
- [Edit photos using the control panel](#)

View and select photos

You can view and select photos on your memory card before or while printing them.

To view and select photos

1. Insert a memory card into the appropriate slot on the HP All-in-One. The **Photosmart Express** menu appears, with the most recent photo shown on the display.



View

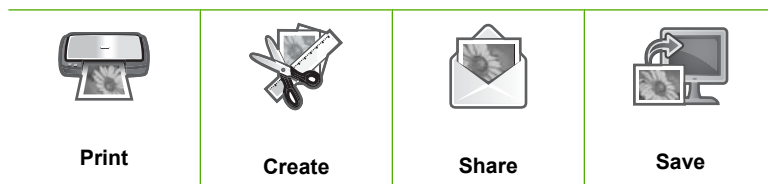

2. Load up to 10 x 15 cm (4 x 6 inch) photo paper in the photo tray or full-size photo paper in the main input tray.
3. Press ► until **View** is highlighted, and then press **OK**.
The **View Photos** screen appears.
4. Press ◀ or ▶ to scroll through the thumbnails of your photos.
5. When the thumbnail of the photo you want to view is highlighted, press **OK**.
6. When the photo appears by itself on the display, press **OK** again.
The **Photo Options** screen appears.
7. With **Print Preview** highlighted, press **OK**.
The **Print Preview** screen appears, showing how your photo will look when printed.
8. If you want to select additional photos to view and print, press ▼ to highlight **Add More**, press **OK**, and repeat steps 4–6.
Or, once you're in the **Add Photos** screen, the quickest way to select multiple photos (if you don't need the option to edit them) is to press ▲ to select a photo, and then press ◀ or ▶ to scroll through more photos to select.

 **TIP:** A checkmark appears to indicate each photo that is selected. You can change the number of copies by pressing ▲ or ▼. The total number of photos that will print appears at the top of the display.

9. (Optional) If you want to check and/or modify any of your print settings, press ▼ to highlight **Settings** and press **OK**.
10. To print the photo(s), use ▲ or ▼ to highlight **Print Now** (or press the **Print Photos** button on the control panel).
A print status screen displays the number of pages to print and the estimated time to complete.

 **TIP:** During printing, you can highlight **Add more photos** and press **OK** to add more photos to the print queue.

Print your photos

You can print the photos on your memory card in a variety of sizes, from 10 x 15 cm (4 x 6 inch) up to the size of letter or A4 paper, including multiple small-size photos on a single page.

To achieve the best print quality, HP recommends using HP papers that are specifically designed for the type of project you are printing along with genuine HP ink. HP papers and HP ink are specifically designed to work well together to provide high-quality output.



To print your photos

 **TIP:** If you want to print only a single borderless 10 x 15 cm (4 x 6 inch) photo on 10 x 15 cm (4 x 6 inch) paper, a shortcut is to simply press **Print Photos** twice on the control panel (once to display the **Print Preview** screen and once to start the print job).

1. Insert a memory card into the appropriate slot on the HP All-in-One. The **Photosmart Express** menu appears, with the most recent photo shown on the display.



View

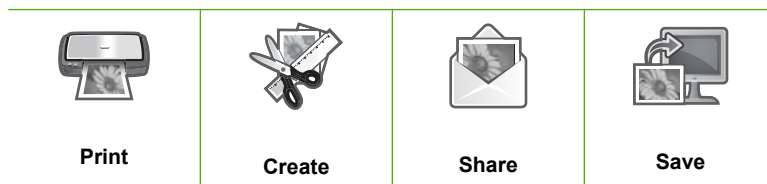

2. Load up to 10 x 15 cm (4 x 6 inch) photo paper in the photo tray or full-size photo paper in the main input tray.
3. Press **▶** until **Print** is highlighted, and then press **OK**. The **Print Layout** screen appears.
4. Press **◀** or **▶** to scroll through the layout options, and press **OK** when the option you want is highlighted:

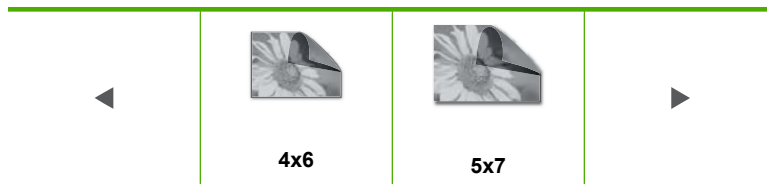

The **Select Photos** screen appears.

5. Press **◀** or **▶** to scroll through the thumbnails of your photos.
6. When you have highlighted the thumbnail of the photo you want to print, press **OK**.
7. When the chosen photo appears by itself on the display, press **▲** to select it. A checkmark appears to indicate that the photo is selected. You can change the number of copies by pressing **▲** or **▼**. The total number of photos that will print appears at the top of the display.
8. Press **◀** or **▶** to continue scrolling through and selecting photos, and then press **OK**. The **Photo Options** menu appears.

9. With **Print Preview** highlighted, press **OK**.
The **Print Preview** screen appears, showing how your photo(s) will look when printed.
10. (Optional) If you want to check and/or modify any of your print settings, use ▲ or ▼ to highlight **Settings** and press **OK**.
11. Use ▲ or ▼ to highlight **Print Now** and press **OK** (or press **Print Photos** on the control panel).
A print status screen displays the number of pages to print and the estimated time to complete.

Create special projects from your photos

The HP All-in-One enables you to create special projects from your photos, including:

- Photo albums
- Panorama prints
- Wallet-size photos
- Passport-size photos

To create special projects

1. Insert a memory card into the appropriate slot on the HP All-in-One.
The **Photosmart Express** menu appears, with the most recent photo shown on the display.



View

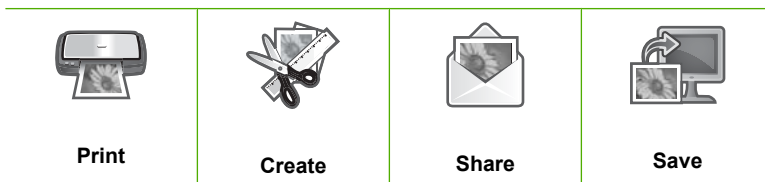

2. Make sure the photo tray or main input tray is loaded with the correct paper for the type of project you are creating.
3. Press ◀ or ▶ to highlight **Create**, and then press **OK**.
The **Create** screen appears.

4. Press ◀ or ▶ to scroll through the projects, and then press **OK** to select the project you want.
 - **Album Pages:** Enables you to select multiple photos and print them onto a series of themed album pages, which you can then bind to create a photo album. The photos in your album pages are placed in the same orientation for a visually pleasing presentation.
 - **Panorama Prints:** Enables you to select multiple photos to "stitch" together to create a single wide view (or panorama) photo. The HP All-in-One automatically aligns the edges of the photos you select to create the smoothest transition from one photo to the next.
 - **Wallets:** Enables you to print your own wallet-size photos to carry with you or give to friends or relatives.
 - **Passport Photos:** Enables you to print your own passport-size photos. (If you have questions on guidelines or restrictions for passport photos, contact a local passport service agency.)
5. Respond to the prompts for the project you are creating.
6. At the **Print Preview** screen, highlight **Print Now**, and then press **OK**.

A print status screen displays the number of pages to print and the estimated time to complete.

Share photos using HP Photosmart Software

You can use the HP Photosmart Software installed on your computer to transfer photos from a memory card to your computer's hard drive for advanced photo editing, sharing photos online, and printing from your computer.

Before transferring photos to your computer, you need to remove the memory card from your digital camera and insert it in the appropriate memory card slot on the HP All-in-One.

To send photos from a memory card

1. Insert a memory card into the appropriate slot on the HP All-in-One.
The **Photosmart Express** menu appears, with the most recent photo shown on the display.



View

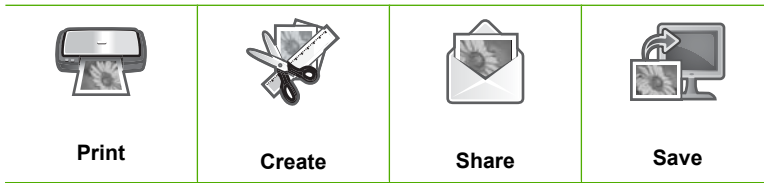

2. Press **▶** until **Share** is highlighted, and then press **OK**.
The **Share Photos** screen appears.
3. Press **◀** or **▶** to scroll through the thumbnails of your photos.
4. When you have highlighted the thumbnail of the photo you want to share, press **OK**.
5. When the chosen photo appears by itself on the display, press **▲** to select it.
A checkmark appears to indicate that the photo is selected.
6. Press **◀** or **▶** to continue scrolling through and selecting photos, and then press **OK**.
The **Share Options** screen appears.
7. Press **▲** or **▼** to highlight **Share**, and then press **OK**.
When the **Share Not Finished** message appears, press **OK** and then follow the onscreen prompts on your computer.

Save photos to your computer

You can use the HP Photosmart Software installed on your computer to transfer photos from a memory card to your computer's hard drive for advanced photo editing, sharing photos online, and printing from your computer.

Before transferring photos to your computer, you need to remove the memory card from your digital camera and insert it in the appropriate memory card slot on the HP All-in-One.

To save photos

1. Insert a memory card into the appropriate slot on the HP All-in-One. The **Photosmart Express** menu appears, with the most recent photo shown on the display.



View



2. Press **▶** until **Save** is highlighted, and then press **OK**.
3. When the **Save to Computer** screen asks you to see the computer monitor for Import photo options, follow the onscreen prompts on your computer to save the photos to your computer.
Only images that were not previously saved are copied to your computer.

Edit photos using the control panel

The HP All-in-One offers several basic editing features that you can use to edit your photos manually before you print them, as well as a feature that enables you to automatically enhance your photos.

This section contains the following topics:

- [Zoom and pan to crop a photo](#)
- [Rotate a photo](#)
- [Adjust the brightness of your photos](#)
- [Print a frame around your photo](#)
- [Apply special color effects to your photos](#)
- [Remove red-eye](#)

- [Automatically enhance your photos](#)
- [Fix a faded original](#)

Zoom and pan to crop a photo

The HP All-in-One enables you to zoom in or out on a specific area of a photo. When you print the photo, the photo is cropped so only the area shown on the display prints.

 **NOTE:** The changes you make to the photo apply only to viewing and printing the photo. The changes will not be saved on the memory card.

To crop a photo

1. Insert a memory card into the appropriate slot on the HP All-in-One.
The **Photosmart Express** menu appears, with the most recent photo shown on the display.
2. With **View** highlighted, press **OK**.
You can use ◀ or ▶ for highlighting options.
The **View Photos** screen appears.
3. Press ◀ or ▶ to scroll through the thumbnails of your photos.
4. When the thumbnail of the photo you want to edit is highlighted, press **OK**.
5. When the selected photo appears by itself on the display, press **OK** again to display the **Photo Options** menu.
6. In the **Photo Options** menu, use ▲ or ▼ to highlight **Edit Photo**, and then press **OK**.
The **Edit Photo** menu appears.
7. Use ▲ or ▼ to highlight **Crop**, and then press **OK**.
The **Crop** screen appears.
8. Press **Zoom In** or **Zoom Out** to zoom closer to or farther away from the subject of the photo.
An outline appears on the photo to show you an approximate view of the area that will print.
9. Press the arrows on the directional pad to pan around the photo and select a specific area to print.
10. Press **OK** to crop the photo.

Rotate a photo

Depending how you were holding your digital camera at the time you took a photo, the photo might appear sideways or upside down on the display. You might need to rotate the photo to make it show or print properly.

 **NOTE:** When printing more than one photo on a page, the HP All-in-One automatically adjusts the orientation of your photos to fit a maximum number of photos on the page. The rotation you apply here is ignored to accommodate the number of photos selected per page.

To rotate a photo

1. Insert a memory card into the appropriate slot on the HP All-in-One.
The **Photosmart Express** menu appears, with the most recent photo shown on the display.
2. With **View** highlighted, press **OK**.
You can use ◀ or ▶ for highlighting options.
The **View Photos** screen appears.
3. Press ◀ or ▶ to scroll through the thumbnails of the photos on your memory card.
4. When the thumbnail of the photo you want to edit is highlighted, press **OK**.
5. When the selected photo appears by itself on the display, press **OK** again to display the **Photo Options** menu.
6. In the **Photo Options** menu, use ▲ or ▼ to highlight **Edit Photo**, and then press **OK**.
The **Edit Photo** menu appears.
7. Use ▲ or ▼ to highlight **Rotate**, and then press **OK**.
The **Rotate** screen appears.
8. Use ◀ or ▶ to flip the image 90 degrees clockwise or counterclockwise.
9. When you are done rotating the image, press **OK**.

Adjust the brightness of your photos

You can adjust the brightness of a photo so that it prints lighter or darker than the original photo you took with your digital camera.

 **NOTE:** The changes you make to the photo apply only to viewing and printing the photo. The changes will not be saved on the memory card.

To adjust the brightness

1. Insert a memory card into the appropriate slot on the HP All-in-One.
The **Photosmart Express** menu appears, with the most recent photo shown on the display.
2. With **View** highlighted, press **OK**.
You can use ◀ or ▶ for highlighting options.
The **View Photos** screen appears.
3. Press ◀ or ▶ to scroll through the thumbnails of the photos on your memory card.
4. When the thumbnail of the photo you want to edit is highlighted, press **OK**.
5. When the selected photo appears by itself on the display, press **OK** again to display the **Photo Options** menu.
6. In the **Photo Options** menu, use ▲ or ▼ to highlight **Edit Photo**, and then press **OK**.
The **Edit Photo** menu appears.
7. Use ▲ or ▼ to highlight **Brightness**, and then press **OK**.
The **Brightness** screen appears.
8. Press ◀ or ▶ to increase or decrease the brightness of the photo.
The current brightness selection is indicated by the vertical line on the sliderbar.
9. When you are done adjusting brightness, press **OK**.

Print a frame around your photo

You can print a decorative colored border around the outside edge of your photo to frame the photo.

 **NOTE:** The changes you make to the photo apply only to viewing and printing the photo. The changes will not be saved on the memory card.

To print a frame around your photo

1. Insert a memory card into the appropriate slot on the HP All-in-One.
The **Photosmart Express** menu appears, with the most recent photo shown on the display.
2. With **View** highlighted, press **OK**.
You can use ◀ or ▶ for highlighting options.
The **View Photos** screen appears.
3. Press ◀ or ▶ to scroll through the thumbnails of your photos.
4. When the thumbnail of the photo you want to edit is highlighted, press **OK**.
5. Press **OK** again to display the **Photo Options** menu.
6. Use ▲ or ▼ to highlight **Edit Photo**, and then press **OK**.
The **Edit Photo** menu appears.
7. Press ▲ or ▼ until **Frame** is highlighted, and then press **OK**.
The **Frame** screen appears.
8. Press ◀ or ▶ to scroll through the frames until you have highlighted the one you want, and then press **OK**.
The selected frame is applied to the photo and shown by itself on the display.

Apply special color effects to your photos

You can apply special color effects to a photo so that it prints with a sepia, hand-tinted, or black-and-white finish.

 **NOTE:** The changes you make to the photo apply only to viewing and printing the photo. The changes will not be saved on the memory card.

To change the color effects

1. Insert a memory card into the appropriate slot on the HP All-in-One.
The **Photosmart Express** menu appears, with the most recent photo shown on the display.
2. With **View** highlighted, press **OK**.
You can use ◀ or ▶ for highlighting options.
The **View Photos** screen appears.
3. Press ◀ or ▶ to scroll through the thumbnails of the photos on your memory card.
4. When the thumbnail of the photo you want to edit is highlighted, press **OK**.
5. When the selected photo appears by itself on the display, press **OK** again to display the **Photo Options** menu.

6. In the **Photo Options** menu, use ▲ or ▼ to highlight **Edit Photo**, and then press **OK**.
The **Edit Photo** menu appears.
7. Use ▲ or ▼ to highlight **Color Effect**, and then press **OK**.
The **Color Effect** menu appears.
8. Use ▲ or ▼ to select one of the following color effect options, and then press **OK**:

No Effect	Does not apply any special color effects to your photo.
Black & White	Prints the photo in black and white.
Sepia	Applies brown tones, similar to photos produced in the early 1900s, to your photo.
Antique	Applies brown tones along with some pale colors to your photo. With this option, your photo will look like it was hand-tinted.

The selected color effect is applied to the photo, and the photo is shown by itself on the display.

Remove red-eye

The flash on a camera (especially on older model cameras) can sometimes cause a subject's eyes to appear red in your photos. You can remove redness so that eyes appear the correct shade in your photos.

 **NOTE:** The changes you make to the photo apply only to viewing and printing the photo. The changes will not be saved on the memory card.

To remove red-eye from photos

1. Insert a memory card into the appropriate slot on the HP All-in-One.
The **Photosmart Express** menu appears, with the most recent photo shown on the display.
2. With **View** highlighted, press **OK**.
You can use ◀ or ▶ for highlighting options.
The **View Photos** screen appears.
3. Press ◀ or ▶ to scroll through the thumbnails of the photos on your memory card.
4. When the thumbnail of the photo you want to edit is highlighted, press **OK**.
5. When the selected photo appears by itself on the display, press the **Red Eye Removal** button on the control panel.

 **TIP:** Another method is to choose **Red Eye Removal** from the **Edit Photo** menu.

A red-eye icon blinks in the upper left corner of the photo, red-eye removal is applied, and the photo is shown by itself on the display.

Automatically enhance your photos

The HP All-in-One is set up, by default, to enhance your photos automatically when you print them. The changes are only visible on your printed output; you cannot see the changes on the display.

When this feature is enabled, the HP All-in-One uses **HP Real Life Technologies** to:

- Adjust the brightness or darkness of your photos (shown in print preview and printed output)
- Adjust the lighting to make dark images appear brighter (shown on printed output only)
- Sharpen blurry images (shown on printed output only)

You can turn off the automatic photo enhancement feature for individual photos, on a per-image basis.

To turn off automatic photo enhancement

1. Insert a memory card into the appropriate slot on the HP All-in-One.
The **Photosmart Express** menu appears, with the most recent photo shown on the display.
2. With **View** highlighted, press **OK**.
You can use ◀ or ▶ for highlighting options.
The **View Photos** screen appears.
3. Press ◀ or ▶ to scroll through the thumbnails of your photos.
4. When the thumbnail of the photo you want to edit is highlighted, press **OK**.
5. When the selected photo appears by itself on the display, press **OK** again to display the **Photo Options** menu.
6. In the **Photo Options** menu, use ▲ or ▼ to highlight **Edit Photo**, and then press **OK**.
The **Edit Photo** menu appears.
7. Use ▲ or ▼ to highlight **Photo Fix**, and then press **OK**.
The **Photo Fix** menu appears.
8. To turn off automatic photo enhancement, use ▲ or ▼ to select **Off**, and then press **OK**.

Fix a faded original

When you are making a reprint of an original photo, an additional option, **Fix Faded Original**, appears in the **Edit Photo** menu. This option enables you to correct old photos that have faded colors. Turning on this option fixes the fading during the final scan.

 **NOTE:** This feature is off by default.

To fix a faded original photo when making a reprint

1. While previewing your scanned reprint, press **OK** to display the **Reprint Options** menu.
2. In the **Reprint Options** menu, use ▲ or ▼ to highlight **Edit Photo**, and then press **OK**.
The **Edit Photo** menu appears.
3. Use ▲ or ▼ to highlight **Fix Faded Original**, and then press **OK** to turn the feature on or off.
The current value of the feature (on or off) appears in the **Edit Photo** menu.

Related topics

[“Make reprints of your photos”](#) on page 79

9 Use the scan features

Scanning is the process of converting text and pictures into an electronic format for your computer. You can scan almost anything (photos, magazine articles and text documents) on the HP All-in-One.

You can use the scanning features of the HP All-in-One to do the following:

- Scan text from an article into your word processor and quote it in a report.
- Print business cards and brochures by scanning a logo and using it in your publishing software.
- Send photos to friends and relatives by scanning your favorite prints and including them in e-mail messages.
- Create a photographic inventory of your house or office.
- Archive treasured photos in an electronic scrapbook.

This section contains the following topics:

- [Make reprints of your photos](#)
- [Scan an image](#)
- [Edit a scanned image](#)
- [Share a scanned image with friends and relatives](#)
- [Stop scanning](#)

Make reprints of your photos

You can scan a printed copy of a photo to make reprints in a variety of sizes, up to the size of letter (8.5 x 11 inch) or A4 (210 x 297 mm) paper.

By default, the HP All-in-One is set to detect the type of paper you are using automatically. For the best results when reprinting photos, leave the **Paper Type** set to **Automatic**, and load photo paper in the HP All-in-One. You should only change the **Paper Type** if you see print quality issues using the **Automatic** setting.



To reprint an original photo

1. Press **Photo Reprints** for the **Scan and Reprint** option.



NOTE: You can also press **Scan Menu** on the control panel for the **Scan and Reprint** option.

NOTE: Depending on the paper size you choose, you can place the photo paper in the photo tray or the main input tray.

2. When prompted, load your original photo print side down on the right front corner of the glass, and then do one of the following:

To reprint your original photo using the default print settings

- ▲ Press **Print Photos** on the control panel.

To change print settings before reprinting your original photo

- a. Press **OK** to change print settings.
The **Source of Original** screen appears.
- b. Press **▲** or **▼** to highlight any option and press **OK**.
The **Print Layout** screen appears.
- c. Press **▲** or **▼** to highlight the print layout pattern and press **OK**.

 **NOTE:** Depending on the paper size you choose, you might be prompted to choose a layout for the photos on your pages.

The **Scan Preview** menu appears.

- d. Press **▲** or **▼** to adjust the number of copies and press **OK**.
The **Reprint Options** screen appears.

 **NOTE:** The HP All-in-One scans your original and shows a preview of the photo on the display.

- e. Press **OK** to select **Print Preview**.

 **NOTE:** Select **Edit Photo** to edit photos before printing.

The **Print Preview** screen appears.

- f. Press **▲** or **▼** to highlight **Print Now** and press **OK** (or press **Print Photos** on the control panel).

Scan an image

You can start a scan from your computer or from the control panel of the HP All-in-One. This section explains how to scan from the control panel of the HP All-in-One only.

 **NOTE:** You can also use the software you installed with the HP All-in-One to scan images. Using this software, you can edit a scanned image and create special projects using a scanned image.

To use the scan features, the HP All-in-One and computer must be connected and turned on. The HP All-in-One software must also be installed and running on your computer prior to scanning. To verify that the HP All-in-One software is running on a Windows computer, look for the HP All-in-One icon in the system tray at the lower right side of the screen, near the time.

 **NOTE:** Closing the **HP Digital Imaging Monitor** icon in the Windows system tray can cause the HP All-in-One to lose some of its scan functionality. If this happens, you can restore full functionality by restarting your computer or by starting the HP Photosmart Software.

This section contains the following topics:

- [Scan an original to a computer](#)
- [Scan an original to a memory card](#)

Scan an original to a computer

You can scan originals placed on the glass by using the control panel.

To scan to a computer

1. Load your original print side down on the right front corner of the glass.
2. Press **Scan Menu** on the control panel.
3. Press ▼ to highlight **Scan to Computer**, and then press **OK**.
4. If the HP All-in-One is connected to one or more computers on a network, do the following:
 - a. Press **OK** to select **Select Computer**.
A list of the computers connected to the HP All-in-One appears on the display.

 **NOTE:** The **Select Computer** menu might list computers with a USB connection in addition to those connected through the network.

- b. Press **OK** to select the default computer, or press ▼ to select a different computer, and then press **OK**.
The **Scan To** menu appears on the display, listing the applications on the selected computer.

If the HP All-in-One is connected directly to a computer with a USB cable, proceed to step 5.

5. Press **OK** to select the default application to receive the scan, or press ▼ to select a different application, and then press **OK**.

 **NOTE:** Alternatively, you can press **Start Scan** instead of **OK**.

A preview image of the scan appears on your computer, where you can edit it.

6. Make any edits to the preview image, and then click **Accept** when you are finished.

Related topics

- [“Control panel features” on page 7](#)
- [“Scan Menu” on page 10](#)

Scan an original to a memory card

You can send the scanned image as a JPEG image to the memory card that is currently inserted. This enables you to use the photo print options to print borderless prints and album pages from the scanned image.

 **NOTE:** If the HP All-in-One is connected to a network, you can access the scanned image only if the memory card is being shared across the network.

To save a scan to a memory card

1. Make sure your memory card is inserted into the appropriate slot on the HP All-in-One.
2. Load your original print side down on the right front corner of the glass.

3. Press **Scan Menu** on the control panel.
4. Press ▼ to highlight **Scan to Memory Card**, and then press **OK**.

 **NOTE:** Alternatively, you can press **Start Scan** instead of **OK**.

The HP All-in-One scans the image and saves the file to the memory card in the JPEG format.

Edit a scanned image

You can edit a scanned image using the software you installed with the HP All-in-One. You can also edit a scanned document by using your Optical Character Recognition (OCR) software.

 **NOTE:** If you are using HP Photosmart Essential, the Optical Character Recognition (OCR) software might not be installed on your computer. To install the OCR software, you must re-insert the software disk and select **OCR** under the **Custom** installation options.

This section contains the following topics:

- [Edit a scanned preview image](#)
- [Edit a scanned photo or graphic](#)
- [Edit a scanned document](#)

Edit a scanned preview image

You can use the tools in the **HP Scanning** software to modify a preview image. Any changes that you make, such as brightness, image type, resolution, and more apply only to this scan session.

You can make additional changes in the HP Photosmart software after the image is scanned.

Edit a scanned photo or graphic

You can edit a scanned photo or graphic using the software you installed with the HP All-in-One. Using this software, you can rotate or crop the image, as well as adjust the brightness, contrast, and color saturation.

Edit a scanned document

Scanning text (also known as optical character recognition or OCR) enables you to bring the content of magazine articles, books, and other printed matter into your favorite word processor and many other programs as fully editable text. Learning to work with OCR correctly is important if you want to obtain the best results. Do not expect scanned text documents to be letter-perfect the first time you use your OCR software. Using OCR software is an art that takes time and practice to master.

 **NOTE:** If you are using HP Photosmart Essential, the Optical Character Recognition (OCR) software might not be installed on your computer. To install the OCR software, you must re-insert the software disk and select **OCR** under the **Custom** installation options.

Share a scanned image with friends and relatives

You can easily share scanned images with friends and family using the HP Photosmart Share online service. HP Photosmart Share enables you to send images to others as e-mail or upload photos to an online photo album or photo finishing service.

 **NOTE:** Availability of the services described here varies by country/region. Some of the services described here might not be available in your country/region.

To send a scan of a photo or document

1. Load your original print side down on the right front corner of the glass.
2. Press **Scan Menu**.
3. Press **OK** to select **HP Photosmart Share** and send the scan to your computer. If the HP All-in-One is connected to one or more computers on a network, a **Select Computer** menu appears. Select the destination computer name.
4. Use the **HP Photosmart Share** Software on your computer to send the scan as thumbnail preview to an e-mail recipient (the full-size file can be downloaded later, at the recipient's convenience), to an online photo album or photo finishing service, or to a network-connected HP device.
5. The HP All-in-One sends the scanned photo or document to the computer or to all the share destinations that you selected.

Related topics

[“Share photos using HP Photosmart Software” on page 70](#)

Stop scanning

To stop scanning

- ▲ Press **Cancel** on the control panel.

10 Use the copy features

The HP All-in-One enables you to produce high-quality color and black-and-white copies on a variety of paper types, including transparencies. You can enlarge or reduce the size of an original to fit a specific paper size, adjust the darkness of the copy, and use special features to make high-quality copies of photos, including borderless copies.

 **TIP:** For the best copy performance on standard copy projects, set the paper size to **Letter** or **A4**, the paper type to **Plain Paper**, and the copy quality to **Fast**.

This section contains the following topics:

- [Make a copy](#)
- [Preview your copy job](#)
- [Change the copy settings for the current job](#)
- [Change default copy settings](#)
- [Perform special copy jobs](#)
- [Stop copying](#)

Make a copy

You can make quality copies from the control panel.

To make a copy from the control panel

1. Make sure you have paper loaded in the input tray.
2. Load your original print side down on the right front corner of the glass.
3. Press **Start Copy Black** or **Start Copy Color** to begin copying.

Preview your copy job

After changing settings on the HP All-in-One for making a copy, you can preview an image of the expected output on the display before starting the copy.

 **NOTE:** You must explicitly pick your copy settings to ensure an accurate preview. Automatic settings will not reflect the loaded paper size and type, but use defaults instead.

Previews appear when you select **Preview** on the **Copy Menu**, or when you use the crop feature to specify a specific area of the original to copy.

To preview your copy from the control panel

1. Press **Copy Menu**.
The **Copy Menu** appears.
2. Change copy settings on the HP All-in-One to accurately reflect the copy you want to make.

3. Press ▼ to highlight **Preview**, and then press **OK**.
An image on the display shows how your copy will print.
4. Press **Start Copy Black** or **Start Copy Color** to accept the preview and begin copying.

Change the copy settings for the current job

You can customize the copy settings of the HP All-in-One to handle nearly any copy task.

This section contains the following topics:

- [Set the number of copies](#)
- [Set the copy paper size](#)
- [Set the copy paper type](#)
- [Change copy speed or quality](#)
- [Adjust the lightness and darkness of your copy](#)

Set the number of copies

You can set the number of copies that you want to print by either using the **Copies** option on the control panel or by selecting the appropriate options in your software application.

To set the number of copies from the control panel

1. Make sure you have paper loaded in the input tray.
2. Load your original print side down on the right front corner of the glass.
3. Press **Copy Menu**.
The **Copy Menu** appears.
4. Press ▼ to highlight **Copies**, and then press **OK**.
The **Copies** option appears.
5. Press ▲ to select the number of copies, up to the maximum.
(The maximum number of copies varies by model.)
6. Press **Start Copy Black** or **Start Copy Color**.

Set the copy paper size

You can set the paper size on the HP All-in-One. The paper size you select should match what is loaded in the input tray.

To set the paper size from the control panel

1. Press **Copy Menu**.
The **Copy Menu** appears.
2. Press ▼ to highlight **Paper Size**, and then press **OK**.
The **Paper Size** menu appears.
3. Press ▼ to highlight the appropriate paper size and then press **OK**.
Refer to the following table to determine which paper size setting to choose, based on the paper loaded in the input tray.

Paper type	Suggested paper size settings
Copier, multi-purpose, or plain papers	8.5x11 inch or A4
Inkjet papers	8.5x11 inch or A4
Letterhead	8.5x11 inch or A4
Photo papers	10x15 cm 4x6 inch 8.5x11 inch A4 L (Japan only) 2L (Japan only) 20x25 cm (Germany only) Mutsugiri (Japan only)
Hagaki	Hagaki (Japan only)
Transparency films	8.5x11 inch or A4

Set the copy paper type

You can set the paper type on the HP All-in-One. The default paper type setting for copying is **Automatic**, which causes the HP All-in-One to detect the type of paper in the input tray.

To set the paper type for copies

1. Press **Copy Menu**.
The **Copy Menu** appears.
2. Press ▼ to highlight **Paper Type**, and then press **OK**.
The **Paper Type** menu appears.
3. Press ▼ until the appropriate paper type appears.
Refer to the following table to determine which paper type setting to choose based on the paper loaded in the input tray.

Paper type	Control panel setting
Copier paper or letterhead	Plain Paper
HP Bright White Paper	Plain Paper

Paper type	Control panel setting
HP Premium Plus Photo Paper, Glossy	Premium Photo
HP Premium Plus Photo Paper, Matte	Premium Photo
HP Premium Plus 10 x 15 cm (4 x 6 inch) Photo Paper	Premium Photo
HP Photo Paper	Photo Paper
HP Everyday Photo Paper	Everyday Photo
HP Everyday Photo Paper, Semi Gloss	Everyday Matte
HP Premium Paper	Premium Inkjet
Other inkjet paper	Premium Inkjet
HP Professional Brochure & Flyer Paper (Glossy)	Brochure Glossy
HP Professional Brochure & Flyer Paper (Matte)	Brochure Matte
HP Premium or Premium Plus Inkjet Transparency Film	Transparency
Other transparency film	Transparency
Plain Hagaki	Plain Paper
Glossy Hagaki	Premium Photo
L (Japan only)	Premium Photo
Advanced Photo Paper	Advanced Photo

4. Press **OK**.

Change copy speed or quality

The HP All-in-One provides four options that affect copy speed and quality:

- **Maximum Resolution** produces the highest quality for all paper. **Maximum Resolution** copies slower than the other quality settings.
- **Best** produces high quality for all paper and eliminates the banding (striping) effect that sometimes occurs in solid areas. **Best** copies slower than the **Normal** or **Fast** quality settings.
- **Normal** delivers high quality and is the recommended setting for most of your copying. **Normal** copies faster than **Best** and is the default setting.
- **Fast** copies faster than the **Normal** setting. The text is comparable to the quality of the **Normal** setting, but the graphics might be lower quality. The **Fast** setting uses less ink and extends the life of your ink cartridges.

To change the copy quality from the control panel

1. Make sure you have paper loaded in the input tray.
2. Load your original print side down on the right front corner of the glass.

3. Press **Copy Menu**.
The **Copy Menu** appears.
4. Press ▼ to highlight **Quality**, and then press **OK**.
The **Quality** menu appears.
5. Press ▼ to select a copy quality.
6. Press **OK**.

Adjust the lightness and darkness of your copy

You can use the **Lighter/Darker** option to adjust the contrast of the copies you make.

To adjust the copy contrast from the control panel

1. Make sure you have paper loaded in the input tray.
2. Load your original print side down on the right front corner of the glass.
3. Press **Copy Menu**.
The **Copy Menu** appears.
4. Press ▼ to highlight **Lighter/Darker**, and then press **OK**.
The **Lighter/Darker** menu appears.
5. Do one of the following:
 - Press ► to darken the copy.
 - Press ◀ to lighten the copy.
6. Press **OK**.

Change default copy settings

When you change copy settings from the control panel, the settings apply only to the current copy job. To apply copy settings to all future copy jobs, you can save the settings as defaults.

To set default copy settings from the control panel

1. Make any needed changes to the Copy settings.
2. Press **Copy Menu**.
The **Copy Menu** appears.
3. Press ▼ to highlight **Set As New Defaults**, and then press **OK**.
The **Set As New Defaults** menu appears.
4. Press ▼ to highlight **Yes, change defaults**, and then press **OK**.

 **NOTE:** The settings you specify here are only saved on the HP All-in-One. They do not adjust the settings in the software. You can save your most frequently used settings by using the software that you installed with the HP All-in-One.

Perform special copy jobs

In addition to supporting standard copy jobs, the HP All-in-One can perform special jobs such as copying borderless photos and resizing originals.

This section contains the following topics:

- [Make a borderless copy of a photo](#)
- [Resize an original to fit onto letter or A4 paper](#)
- [Resize an original using custom settings](#)
- [Crop an original](#)
- [Shift the left margin](#)
- [Improve the quality of a copy](#)

Make a borderless copy of a photo

For the best quality when copying a photo, load 10 x 15 cm (4 x 6 inch) photo paper in the photo tray and change your copy settings for the correct paper type and photo enhancement.

To make a borderless copy of a photo from the control panel

1. Load up to 10 x 15 cm (4 x 6 inch) photo paper into the photo tray.

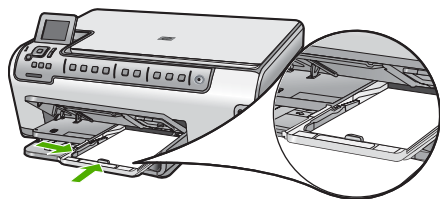

2. Load your original photo print side down on the right front corner of the glass. Position the photo on the glass so the long edge of the photo is along the front edge of the glass, as indicated by the engraved guides along the edge of the glass.
3. Press **Start Copy Black** or **Start Copy Color**.
The HP All-in-One makes a borderless copy of your original photo.

 **NOTE:** If you loaded tabbed paper in the photo tray, you can remove the tab from the copy of your photo once the ink has completely dried.

 **TIP:** If the output is not borderless set the paper type to **Premium Photo**, and then try making the copy again.

Related topics

- [“Load 10 x 15 cm \(4 x 6 inch\) photo paper”](#) on page 38
- [“Set the copy paper type”](#) on page 87

Resize an original to fit onto letter or A4 paper

You can use the **Fit to Page** feature to copy an original to fit within the printable margins of a page without the risk of cropping some part of your original. This is useful for reducing or enlarging an original. For example:

- If you enlarge a 10 x 15 cm (4 x 6 inch) photo to make a borderless full-size copy on letter or A4 paper, some part of your photo will be cropped. The **Fit to Page** feature will enlarge the photo as much as possible to fit the page without cropping any part of your photo.
- If the image or text on your original fills the entire sheet of paper with no margins, you can use the **Fit to Page** feature to reduce your original and prevent unwanted cropping of the text or images at the edges of the sheet.

 **NOTE:** In order to resize your original without changing the proportions or cropping the edges, the HP All-in-One might leave an uneven amount of white space around the edges of the paper.



To resize a document from the control panel

1. Make sure you have paper loaded in the input tray.
2. Load your original print side down on the right front corner of the glass.
3. Press **Copy Menu**.
The **Copy Menu** appears.
4. Press ▼ to highlight **Size**, and then press **OK**.
The **Size** menu appears.
5. Press ▼ to highlight **Fit to Page**, and then press **OK**.

Resize an original using custom settings

You can use your own custom settings to reduce or enlarge a copy of a document.

To set a custom size from the control panel

1. Make sure you have paper loaded in the input tray.
2. Load your original print side down on the right front corner of the glass.
3. Press **Copy Menu**.
The **Copy Menu** appears.
4. Press ▼ to highlight **Size**, and then press **OK**.
The **Size** menu appears.
5. Press ▼ to highlight **Custom 100%**, and then press **OK**.
The **Custom 100%** menu appears.

6. Press ▼ or ▲ to select a percentage to reduce or enlarge the copy.
(The minimum and maximum percentage to resize a copy varies by model.)
7. Press **OK**.

Crop an original

After changing settings on the HP All-in-One for making a copy, you can use the crop feature to specify a particular area of the original to copy.

To crop your copy from the control panel

1. Press **Copy Menu**.
The **Copy Menu** appears.
2. Change copy settings on the HP All-in-One to accurately reflect the copy you want to make.
3. Press ▼ to highlight **Crop**, and then press **OK**.
The **Crop** screen appears.
4. Press the arrows on the directional pad to move the cursor to the upper left corner where you want the crop to begin, and then press **OK**.
5. Press ▼ and ► to move the cursor to the lower right corner of the crop area, and then press **OK**.
The HP All-in-One shows a preview image of the expected output on the display.
6. Press **Start Copy Black** or **Start Copy Color** to accept the preview and begin copying.

Shift the left margin

You can shift the left margin of the copies by using the **Margin Shift** option. This helps in binding or 3-hole punching for the copies produced. The HP All-in-One shifts the image on the copies produced 0.95 cm (3/8 inch) to the right.



NOTE: When the **Margin Shift** feature is enabled, the right side of the copy images may be cropped.

To shift the margin for your copy from the control panel

1. Press **Copy Menu**.
The **Copy Menu** appears.
2. Change copy settings on the HP All-in-One to accurately reflect the copy you want to make.
3. Press ▼ to highlight **Margin Shift**, and then press **OK**.
The **Margin Shift** menu appears.
4. Press ▼ to highlight **On**, and then press **OK**.
5. Press **Start Copy Black** or **Start Copy Color** to begin copying.

Improve the quality of a copy

You can use the **Enhancements** feature to adjust the quality of text documents by sharpening edges of black text or adjust photographs by enhancing light colors that might otherwise appear white.

The **Mixed** enhancement is the default option. Use the **Mixed** enhancement to sharpen edges of most originals. You can use **Photo** enhancements to enhance light colors that might otherwise appear white.

If any of the following occur, turn off **Text** enhancement by selecting **Photo** or **None**:

- Stray dots of color surround some text on your copies
- Large, black typefaces look splotchy (not smooth)
- Thin, colored objects or lines contain black sections
- Horizontal grainy or white bands appear in light- to medium-gray areas

To copy a blurred document from the control panel

1. Make sure you have paper loaded in the input tray.
2. Load your original print side down on the right front corner of the glass.
3. Press **Copy Menu**.
The **Copy Menu** appears.
4. Press ▼ to highlight **Enhancements**, and then press **OK**.
The **Enhancements** menu appears.
5. Press ▼ to highlight **Text**, and then press **OK**.
6. Press **Start Copy Black** or **Start Copy Color**.

To copy an overexposed photo

1. Make sure you have paper loaded in the input tray.
2. Position the photo on the glass so the long edge of the photo is along the front edge of the glass.
Load your original print side down on the right front corner of the glass.
3. Press **Copy Menu**.
The **Copy Menu** appears.
4. Press ▼ to highlight **Enhancements**, and then press **OK**.
The **Enhancements** menu appears.
5. Press ▼ to highlight **Photo**, and then press **OK**.
6. Press **Start Copy Black** or **Start Copy Color**.

Stop copying

To stop copying

- ▲ Press **Cancel** on the control panel.

11 Print reports and forms

The HP All-in-One enables you to print self-test reports. You can also print forms such as ruled papers and checklists.

This section contains the following topics:

- [Print a self-test report](#)
- [Print forms](#)

Print a self-test report

If you are experiencing problems with printing, print a self-test report before you replace the ink cartridges. This report provides useful information on several aspects of your device, including your ink cartridges.

To print a self-test report

1. Load letter, A4, or legal unused plain white paper into the input tray.
2. Press **Setup**.
3. Press ▼ to highlight **Tools**, and then press **OK**.
4. Press ▼ to highlight **Self-Test Report**, and then press **OK**.

The HP All-in-One prints a self-test report, which contains the following information:

- **Product information:** includes the model number, serial number, and other product information.
- **Revision information:** includes the firmware version number.
- **Ink delivery system information:** displays the approximate ink level of each installed ink cartridge, the status of each ink cartridge, the date each cartridge was installed, and the date each cartridge will expire.
- **Print quality pattern:** displays six color blocks, representing each of the six installed cartridges. Solid, even blocks of color indicate there are no print quality problems. When streaks are displayed or there are missing blocks, clean the print head using the procedure described in [“Clean the print head” on page 103](#). If the color blocks still show print quality problems after cleaning the print head, align the printer using the procedure described in [“Align the printer” on page 102](#). If the color blocks continue to show print quality problems after cleaning and aligning, contact HP support.

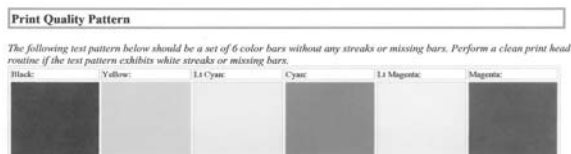

- **History log:** contains information that might be used for diagnostic purposes if you need to call HP support.

Print forms

The HP All-in-One contains built-in templates that enable you to print common forms, such as narrow or wide ruled notebook paper, graph paper, task checklists, and music sheets on plain letter- or A4-size paper.

To print forms from the control panel

1. Make sure you have paper loaded in the input tray.
2. Press **Setup**.
The **Setup** menu appears.
3. Press ▼ to highlight **Printable School Papers**, and then press **OK**.
The **Printable School Papers** menu appears.
4. Press ▼ to highlight the form you want to print, and then press **OK**.
5. Press ▲ or ▼ to enter the number of pages you want to print, and then press **OK**.

12 Maintain the HP All-in-One

The HP All-in-One requires little maintenance. Sometimes you might want to clean the glass and lid backing to remove surface dust and ensure that your copies and scans remain clear. You will also need to replace ink cartridges, clean the print head assembly, or align the printer from time to time. This section provides instructions for keeping the HP All-in-One in top working condition. Perform these simple maintenance procedures as necessary.

This section contains the following topics:

- [Clean the HP All-in-One](#)
- [Check the estimated ink levels](#)
- [Work with ink cartridges](#)
- [Reduce energy consumption when the HP All-in-One is off](#)
- [Self-maintenance sounds](#)
- [Turn off the HP All-in-One](#)

Clean the HP All-in-One

To ensure that your copies and scans remain clear, you might need to clean the glass and lid backing. You might also want to dust the exterior of the HP All-in-One.

 **TIP:** You can purchase an HP Cleaning Kit for Inkjet Printers and All-in-Ones (Q6260A) that provides everything needed to safely clean your HP device. For more information, go to: www.shopping.hp.com/accessories-store/printer.

This section contains the following topics:

- [Clean the glass](#)
- [Clean the lid backing](#)
- [Clean the exterior](#)

Clean the glass

Fingerprints, smudges, hair, and dust on the main glass surface slow down performance and affect the accuracy of the copy and scan features.

To clean the glass

1. Turn off the HP All-in-One, and raise the lid.
2. Clean the glass with a soft cloth or sponge slightly moistened with a nonabrasive glass cleaner.

 **CAUTION:** Do not use abrasives, acetone, benzene, or carbon tetrachloride on the glass, since they can damage it. Do not place or spray liquid directly on the glass. The liquid might seep under the glass and damage the device.

3. Dry the glass with a dry, soft, lint-free cloth to prevent spotting.
4. Turn on the HP All-in-One.

Clean the lid backing

Minor debris can accumulate on the white document backing located underneath the lid of the HP All-in-One.

To clean the lid backing

1. Turn off the HP All-in-One, and raise the lid.
2. Clean the white document backing with a soft cloth or sponge slightly moistened with a mild soap and warm water.
Wash the backing gently to loosen debris. Do not scrub the backing.
3. Dry the backing with a dry, soft, lint-free cloth.

△ **CAUTION:** Do not use paper-based wipes, as these might scratch the backing.

4. If further cleaning is needed, repeat the previous steps using isopropyl (rubbing) alcohol, and wipe the backing thoroughly with a damp cloth to remove any residual alcohol.

△ **CAUTION:** Be careful not to spill alcohol on the glass or exterior of the HP All-in-One, as this might damage the device.

Clean the exterior

Use a soft cloth or slightly moistened sponge to wipe dust, smudges, and stains off the case. The interior of the HP All-in-One does not require cleaning. Keep fluids away from the control panel and the interior of the HP All-in-One.

△ **CAUTION:** To avoid damage to the exterior of the HP All-in-One, do not use alcohol or alcohol-based cleaning products.

Check the estimated ink levels

You can easily check the ink supply level to determine how soon you might need to replace an ink cartridge. The ink supply level shows an estimate of the amount of ink remaining in the ink cartridges.

 **NOTE:** The HP All-in-One can only detect the ink levels for genuine HP ink. The ink levels in ink cartridges that are refilled or have been used in other devices might not register accurately.

NOTE: Ink from the cartridges is used in the printing process in a number of different ways, including in the initialization process, which prepares the device and cartridges for printing, and in printhead servicing, which keeps print nozzles clear and ink flowing smoothly. In addition, some residual ink is left in the cartridge after it is used. For more information, see www.hp.com/go/inkusage.

To check the ink levels from the control panel

1. Press **Setup**.
2. Press ▼ to highlight **Tools**, and then press **OK**.

3. Press ▼ to highlight **Display Ink Gauge**, and then press **OK**.
The HP All-in-One displays a gauge that shows the estimated ink levels of all cartridges installed.

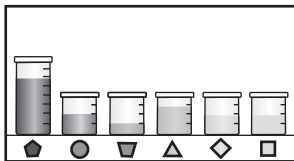

4. Press any button to return to the **Tools** menu.

To check the ink levels from the HP Photosmart Software

1. In the HP Solution Center, click **Settings**, point to **Print Settings**, and then click **Printer Toolbox**.

 **NOTE:** You can also open the **Printer Toolbox** from the **Print Properties** dialog box. In the **Print Properties** dialog box, click the **Services** tab, and then click **Service this device**.

The **Printer Toolbox** appears.

2. Click the **Estimated Ink Level** tab.
The estimated ink levels for the ink cartridges appear.

 **TIP:** You can also print a self-test report to see if ink cartridges might need to be replaced.

Related topics

[“Print a self-test report” on page 95](#)

Work with ink cartridges

To ensure the best print quality from the HP All-in-One, you will need to perform some simple maintenance procedures and, when prompted by a message on the display, replace the ink cartridges.

This section contains the following topics:

- [Replace the ink cartridges](#)
- [Align the printer](#)
- [Clean the print head](#)
- [Clean the ink cartridge contacts](#)
- [Remove ink from your skin and clothing](#)

Replace the ink cartridges

Follow these instructions when you need to replace ink cartridges.

 **NOTE:** If you are installing ink cartridges in the HP All-in-One for the first time, be sure to use only the ink cartridges that came with the device. The ink in these cartridges is specially formulated to mix with the ink in the print head assembly at first-time setup.

If you do not already have replacement ink cartridges for the HP All-in-One, to order cartridges, go to www.hp.com/buy/supplies. If prompted, choose your country/region, follow the prompts to select your product, and then click one of the shopping links on the page.



To replace the ink cartridges

1. Make sure the HP All-in-One is turned on.
2. Open the ink cartridge door by lifting from the front center of the device, until the door locks into place.

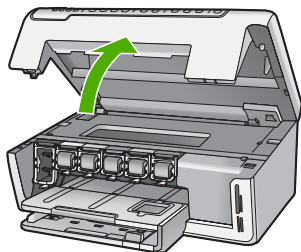

3. Squeeze the bottom of the latch below the ink cartridge you want to replace, and then lift the latch.
If you are replacing the black ink cartridge, lift the latch on the far left.

If you are replacing one of the five color ink cartridges, such as yellow, light cyan (blue), cyan, light magenta (pink), or magenta, lift the appropriate latch in the center area.

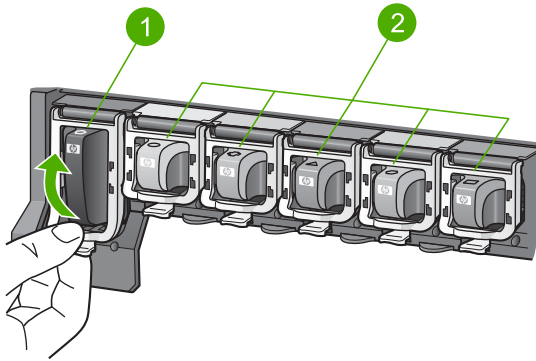

- | | |
|---|--|
| 1 | Ink cartridge latch for the black ink cartridge |
| 2 | Ink cartridge latches for the color ink cartridges |

4. Pull the ink cartridge toward you out of its slot to remove it.

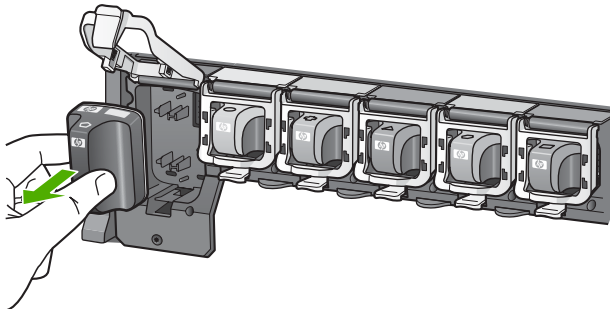

5. Remove the new ink cartridge from its packaging, and then, holding it by the handle, push the ink cartridge into the empty slot. Match the color and pattern of the ink cartridge to the color and pattern on the print carriage.

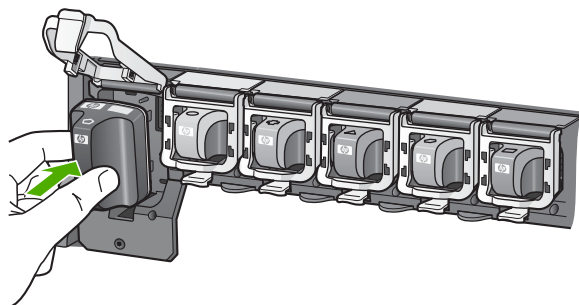

6. Close the latch and make sure it is secure.

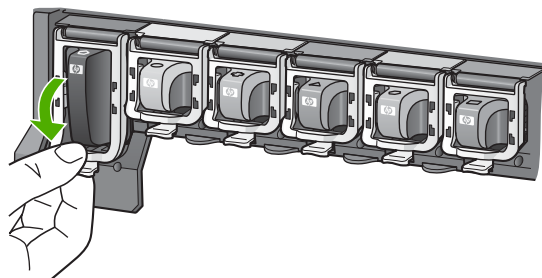

7. Repeat steps 3 through 6 for each ink cartridge you are replacing.
8. Close the ink cartridge door.

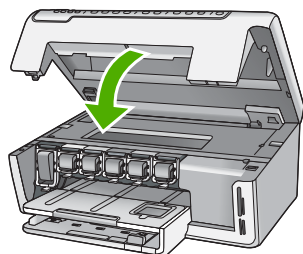

Related topics

["Shop for ink supplies" on page 107](#)

Align the printer

The HP All-in-One automatically aligns the print head when you install the ink cartridges during the initial setup. The HP All-in-One also aligns the print head during periodic

maintenance to ensure excellent print quality. You might want to use this feature when the self-test report shows streaking or white lines through any of the blocks of color.

If you still have print quality problems after aligning the printer, try cleaning the print head. If print quality problems persist after aligning and cleaning, contact HP support.

To align the printer from the control panel

1. Load letter, A4, or legal unused plain white paper into the input tray.
2. Press **Setup**.
The **Setup** menu appears.
3. Press ▼ to highlight **Tools**, and press **OK**.
The **Tools** menu appears.
4. Press ▼ to highlight **Align Printer**, and press **OK**.
5. The HP All-in-One prints a test page, aligns the print head, and calibrates the printer.
Recycle or discard the page.
A success or failure message appears.

 **NOTE:** If you have colored paper loaded in the input tray when you align the printer, the alignment will fail. Load unused plain white paper into the input tray, and then try the alignment again.

6. Press **OK** to continue.

To align the printer from the HP Photosmart Software

1. Load letter, A4, or legal unused plain white paper into the input tray.
2. In the HP Solution Center, click **Settings**, point to **Print Settings**, and then click **Printer Toolbox**.

 **NOTE:** You can also open the **Printer Toolbox** from the **Print Properties** dialog box. In the **Print Properties** dialog box, click the **Services** tab, and then click **Service this device**.

The **Printer Toolbox** appears.

3. Click the **Device Services** tab.
4. Click **Align the Printer**.
The HP All-in-One prints a test page, aligns the print head, and calibrates the printer.
Recycle or discard the page.

Related topics

[“Clean the print head” on page 103](#)

Clean the print head

Use this feature when the self-test report shows streaking or white lines through any of the blocks of color. Do not clean the print head unnecessarily, as this wastes ink and shortens the life of the ink nozzles on the print head.

To clean the print head from the control panel

1. Load letter or A4 unused plain white paper into the input tray.
2. Press **Setup**.
3. Press ▼ to highlight **Tools**, and then press **OK**.
4. Press ▼ to highlight **Clean Printhead**, and then press **OK**.
The HP All-in-One cleans the print head and prints a page that you can recycle or discard.

To clean the print head from the HP Photosmart Software

1. Load letter, A4, or legal unused plain white paper into the input tray.
2. In the HP Solution Center, click **Settings**, point to **Print Settings**, and then click **Printer Toolbox**.



NOTE: You can also open the **Printer Toolbox** from the **Print Properties** dialog box. In the **Print Properties** dialog box, click the **Services** tab, and then click **Service this device**.

The **Printer Toolbox** appears.

3. Click the **Device Services** tab.
4. Click **Clean the Print Head**.
5. Follow the prompts until you are satisfied with the quality of the output, and then click **Done**.

If print quality still seems poor after you clean the print head, try aligning the printer.

If print quality problems persist after cleaning and aligning, contact HP support.

Related topics

[“Align the printer” on page 102](#)

Clean the ink cartridge contacts

Clean the copper-colored ink cartridge contacts if all ink cartridges are installed and a message appears on the display that says a cartridge is missing or damaged.

Before cleaning the ink cartridge contacts, remove the ink cartridge and verify that nothing is covering the ink cartridge contacts or the ink cartridge slot, then reinstall the ink cartridge. If you continue to get a message that says a cartridge is missing or damaged, clean the ink cartridge contacts. If you still get this message after cleaning the contacts, you will need a replacement ink cartridge. Remove the affected ink cartridge and look at the end-of-warranty date on the bottom. If it is before the end-of-warranty date, contact HP support to obtain a replacement ink cartridge.

Make sure you have the following materials available:

- Dry foam rubber swabs, lint-free cloth, or any soft material that will not come apart or leave fibers.
- Distilled, filtered, or bottled water (tap water might contain contaminants that can damage the ink cartridges).

△ **CAUTION:** Do **not** use platen cleaners or alcohol to clean the ink cartridge contacts. These can damage the ink cartridge or the HP All-in-One.

To clean the ink cartridge contacts

1. Make sure the HP All-in-One is turned on.
2. Lift the ink cartridge door.
3. Squeeze the bottom of the latch below the ink cartridge you want to clean, and then lift the latch.

 **NOTE:** Do not remove multiple ink cartridges at the same time. Remove and clean each ink cartridge one at a time. Do not leave an ink cartridge outside the HP All-in-One for more than 30 minutes.

4. Inspect the ink cartridge contacts for ink and debris buildup.
5. Dip a clean foam rubber swab or lint-free cloth into distilled water, and squeeze any excess water from it.

 **NOTE:** Hold the ink cartridge by its handle. Do not touch the copper-colored contacts with your hands or anything other than a foam rubber swab or lint-free cloth.

6. Clean only the copper-colored contacts.

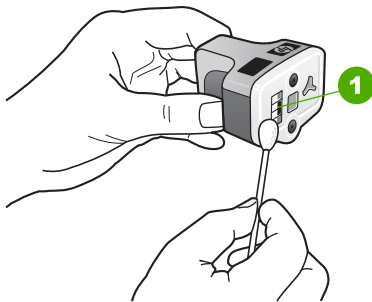

1	Copper-colored contacts
---	-------------------------

7. Place the ink cartridge back into the empty slot and press down on the gray latch until it clicks into place.
8. Repeat if necessary for the other ink cartridges.
9. Gently close the ink cartridge door.

Related topics

- [“Replace the ink cartridges” on page 99](#)
- [“Ink cartridge warranty information” on page 169](#)

Remove ink from your skin and clothing

Follow these instructions to remove ink from your skin and clothing:

Surface	Remedy
Skin	Wash the area with an abrasive soap.
White fabric	Wash the fabric in <i>cold</i> water and use chlorine bleach.
Color fabric	Wash the fabric in <i>cold</i> water and use sudsy ammonia.

△ **CAUTION:** Always use cold water to remove ink from fabric. Warm or hot water can set the ink into the fabric.

Reduce energy consumption when the HP All-in-One is off

When the HP All-in-One is off, an amount of energy is still being consumed. Energy consumption can be lessened by enabling the Standby/Off state.

📄 **NOTE:** When the HP All-in-One is in the Standby/Off state, it will take longer than usual to turn back on.

To enable the Standby/Off state

▲ Press and hold the **On** button for 3 seconds until the HP All-in-One turns off.

Self-maintenance sounds

The HP All-in-One will make mechanical noises at various times to perform periodic maintenance functions, such as replenishing the ink levels in the print head assembly or cleaning the print head. This is normal operation and is necessary to ensure the HP All-in-One produces the best quality printouts.

△ **CAUTION:** A message on the display will notify you when the HP All-in-One is performing maintenance functions. Do not remove power from the device during this time.

Turn off the HP All-in-One

To avoid damaging the HP All-in-One, you must properly shut it down by using the **On** button located on the device. Do not turn the HP All-in-One off by unplugging the power cord or turning off a power strip.

13 Shop for ink supplies

For a list of ink cartridge numbers, see the printed documentation that came with the HP All-in-One. You can also use the software that came with the HP All-in-One to find out the reorder number for all the ink cartridges. You can order ink cartridges online from the HP Web site. Additionally, you can contact a local HP reseller to find out the correct ink cartridge reorder numbers for your device and purchase ink cartridges.

To order genuine HP supplies for the HP All-in-One, go to www.hp.com/buy/supplies. If prompted, choose your country/region, follow the prompts to select your product, and then click one of the shopping links on the page.

 **NOTE:** Ordering ink cartridges online is not supported in all countries/regions. If it is not supported in your country/region, contact a local HP reseller for information about purchasing ink cartridges.

To order ink cartridges from your desktop

▲ Click the **Shop for HP Supplies** icon on your desktop to connect to HP SureSupply. You will see a list of original HP printing supplies that are compatible with your device, as well as options to conveniently purchase the supplies you need (options vary by country/region).

If you deleted this icon from your desktop, click the **Start** menu, point to the **HP** folder, then click **Shop for Supplies**.

To order HP printing supplies through the HP Solution Center

1. In the HP Solution Center, click **Settings**, point to **Print Settings**, and then click **Printer Toolbox**.

 **NOTE:** You can also open the **Printer Toolbox** from the **Print Properties** dialog box. In the **Print Properties** dialog box, click the **Services** tab, and then click **Service this device**.

2. Click the **Estimated Ink Levels** tab.

3. Click **Ink Cartridge Ordering Information**.

The ink cartridge reorder numbers appear.

4. Click **Order Online**.

HP sends detailed printer information, including model number, serial number, and ink supply levels, to an authorized online reseller. The supplies you need are preselected; you can change quantities, add or remove items, and then check out.

14 Troubleshooting

This section contains the following topics:

- [Troubleshooting tips](#)
- [Hardware setup troubleshooting](#)
- [Software installation troubleshooting](#)
- [Network troubleshooting](#)
- [Print quality troubleshooting](#)
- [Print troubleshooting](#)
- [Memory card troubleshooting](#)
- [Scan troubleshooting](#)
- [Copy troubleshooting](#)
- [Errors](#)

Troubleshooting tips

This section contains the following topics:

- [Communication problems over a USB connection](#)
- [Information on ink cartridges and the print head](#)
- [Information on paper](#)
- [Clear paper jams](#)

Communication problems over a USB connection

 **NOTE:** For information on network communication problems, see “[Network troubleshooting](#)” on page 120. For information on communication problems involving a memory card, see “[Memory card troubleshooting](#)” on page 139.

If the HP All-in-One and computer are USB-connected and are not communicating with each other, try the following:

- Look at the display on the HP All-in-One. If the display is blank and the **On** button is not lit, the HP All-in-One is turned off. Make sure the power cord is firmly connected to the HP All-in-One and plugged into a power outlet. Press the **On** button to turn on the HP All-in-One.
- Check the USB cable. If you are using an older cable, it might not be working properly. Try connecting it to another product to see if the USB cable works. If you experience problems, the USB cable might need to be replaced. Also verify that the cable does not exceed 3 meters (9.8 feet) in length.
- Check the connection from the HP All-in-One to your computer. Verify that the USB cable is securely plugged into the USB port on the back of the HP All-in-One. Make

sure the other end of the USB cable is plugged into a USB port on your computer. After the cable is connected properly, turn the HP All-in-One off and then on again.

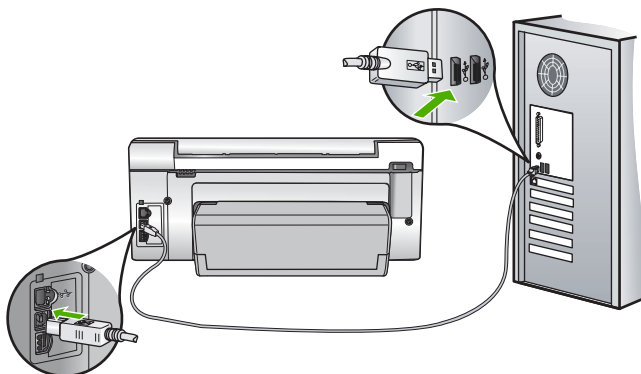

- If you are connecting the HP All-in-One through a USB hub, make sure the hub is turned on. If the hub is on, try connecting directly to your computer.
- Check other printers or scanners. You might need to disconnect older products from your computer.
- Try connecting the USB cable to another USB port on your computer. After you check the connections, try restarting your computer. Turn the HP All-in-One off and then on again.
- If necessary, remove the software you installed with the HP All-in-One and then install it again.

For more information, see:

[“Uninstall and reinstall the software” on page 118](#)

Information on ink cartridges and the print head

The following tips help maintain HP ink cartridges and ensure consistent print quality.

- Install the ink cartridge on or before the install by date, which is printed on the ink cartridge package.
 - Keep all ink cartridges in the original sealed packages until they are needed.
 - Turn off the HP All-in-One by pressing the **On** button located on the device. Do not turn off the device by turning off a power strip or unplugging the power cord from the HP All-in-One. If you improperly turn off the HP All-in-One, the print head assembly might not return to the correct position.
 - Store ink cartridges at room temperature (15.6°-26.6° C or 60°-78° F).
 - HP recommends that you do not remove the ink cartridges from the HP All-in-One until you have replacement cartridges available to install.
- If you are transporting the HP All-in-One make sure you turn off the device by pressing the **On** button to power it down properly. Also, make sure you leave the ink cartridges installed. Doing these actions will prevent ink leaking from the print head assembly.
- Clean the print head when you notice a significant decrease in print quality.

- Do not clean the print head unnecessarily. This wastes ink and shortens the life of the cartridges.
- Handle ink cartridges carefully. Dropping, jarring, or rough handling during installation can cause temporary printing problems.

Information on paper

The HP All-in-One is designed to work well with most paper types. Test a variety of paper types before buying a large quantity. Find a paper type that works well and is easy to purchase. HP Premium papers are designed for the best quality results. In addition, follow these tips:

- Do not use paper that is too thin, that has a slick texture, or that stretches easily. It can feed incorrectly through the paper path, causing paper jams.
- Store photo media in its original packaging inside a resealable plastic bag on a flat surface in a cool, dry place. When you are ready to print, remove only the paper you plan to use immediately. When you have finished printing, return any unused photo paper to the plastic bag.
- Always hold photo paper by the edges. Fingerprints on photo paper can reduce print quality.
- Do not use paper that is heavily textured. It can cause graphics or text to print improperly.
- Do not combine different paper types and paper sizes in the input tray; the entire stack of paper in the input tray must be the same size and type.
- Store printed photos under glass or in a storage book to prevent bleeding over time from high humidity. Use HP Premium Plus photo paper for maximum performance.

Clear paper jams

If the HP All-in-One has a paper jam, check the Two-sided printing accessory.



To clear a paper jam from the Two-sided printing accessory

1. Turn off the HP All-in-One.
2. Press in the tabs on the left and right side of the Two-sided printing accessory. Remove the accessory by pulling it away from the HP All-in-One.

△ **CAUTION:** Trying to clear a paper jam from the front of the HP All-in-One can damage the print mechanism. Always access and clear paper jams from the Two-sided printing accessory of the HP All-in-One.

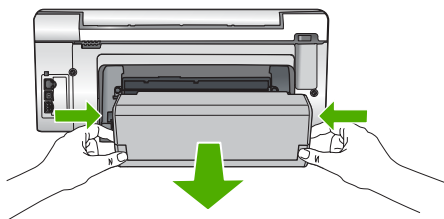

3. Gently pull the paper out of the rollers.

△ **CAUTION:** If the paper tears when you are removing it from the rollers, check the rollers and wheels for torn pieces of paper that might be remaining inside the device. If you do not remove all the pieces of paper from the HP All-in-One, more paper jams are likely to occur.

4. If the paper jam is cleared, proceed to step 5.
If the paper jam is not cleared, do the following:
 - a. Open the Two-sided printing accessory by pulling the tabs up.
 - b. Remove any paper from inside the accessory.
 - c. Close the Two-sided printing accessory by pressing the tabs down until they lock into place.
5. Replace the Two-sided printing accessory. Gently push the accessory forward until it snaps into place.
6. Turn on the HP All-in-One, and then press **OK** to continue the current job.

Hardware setup troubleshooting

This section contains hardware troubleshooting information for the HP All-in-One.

Many issues are caused when the HP All-in-One is connected to the computer using a USB cable before the HP All-in-One software is installed on the computer. If you connected the HP All-in-One to your computer before the software installation screen prompts you to do so, you must follow these steps:

Troubleshooting common setup issues

1. Disconnect the USB cable from the computer.
2. Uninstall the software (if you have already installed it).
3. Restart your computer.
4. Turn off the HP All-in-One, wait one minute, then restart it.
5. Reinstall the HP All-in-One software.

△ **CAUTION:** Do not connect the USB cable to the computer until prompted by the software installation screen.

This section contains the following topics:

- [The HP All-in-One will not turn on](#)
- [I connected the USB cable, but I am having problems using the HP All-in-One with my computer](#)
- [The display shows the wrong language](#)
- [The wrong measurements are showing in menus on the display](#)
- [I received a message on the display that the printer alignment failed](#)
- [The HP All-in-One does not print](#)
- [I received a message on the display about a paper jam or a blocked print head assembly](#)

The HP All-in-One will not turn on

Cause: The HP All-in-One is not properly connected to a power supply.

Solution:

- Make sure the power cord is firmly connected to both the HP All-in-One and the power adapter. Plug the power cord into a grounded power outlet, surge protector, or power strip.

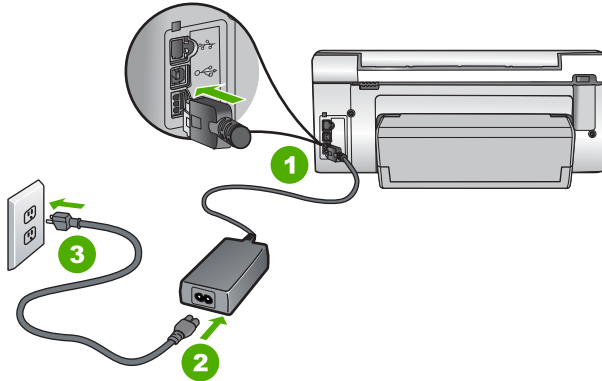

1	Power connection
2	Power cord and adapter
3	Grounded power outlet

- If you are using a power strip, make sure the power strip is on. Or, try plugging the HP All-in-One directly into a grounded power outlet.
- Test the power outlet to make sure it is working. Plug in an appliance that you know works, and see if the appliance has power. If not, then there might be a problem with the power outlet.
- If you plugged the HP All-in-One into a switched outlet, make sure the switch is on. If it is switched to on but still does not work, then there might be a problem with the power outlet.

Cause: You pressed the **On** button too quickly.

Solution: The HP All-in-One might not respond if you press the **On** button too quickly. Press the **On** button once. It might take a few minutes for the HP All-in-One to turn on. If you press the **On** button again during this time, you might turn the device off.

△ **CAUTION:** If the HP All-in-One still does not turn on, it might have a mechanical failure. Unplug the HP All-in-One from the power outlet and contact HP. Go to: www.hp.com/support. If prompted, choose your country/region, and then click **Contact HP** for information on calling for technical support.

I connected the USB cable, but I am having problems using the HP All-in-One with my computer

Cause: The USB cable was connected before the software was installed. Connecting the USB cable before prompted can cause errors.

Solution: You must first install the software that came with the HP All-in-One before connecting the USB cable. During installation, do not plug in the USB cable until prompted by the onscreen instructions.

Once you have installed the software, connecting your computer to the HP All-in-One with a USB cable is straightforward. Simply plug one end of the USB cable into the back of your computer and the other into the back of the HP All-in-One. You can connect to any USB port on the back of your computer.

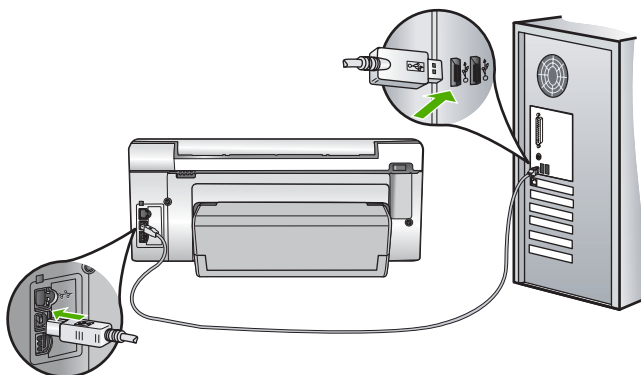

For more information on installing the software and connecting the USB cable, see the Setup Guide that came with the HP All-in-One.

The display shows the wrong language

Cause: You might have selected the incorrect language when setting up the HP All-in-One.

Solution: You can change the language settings at any time from the **Preferences** menu.

For more information, see:

[“Set your language and country/region” on page 15](#)

The wrong measurements are showing in menus on the display

Cause: You might have selected the incorrect country/region when setting up the HP All-in-One. The country/region you select determines the paper sizes shown on the display.

Solution: You can change the country/region settings from the **Preferences** menu. For more information, see:

[“Set your language and country/region” on page 15](#)

I received a message on the display that the printer alignment failed

Cause: The incorrect type of paper is loaded in the input tray (for example, colored paper, paper with text on it or, certain recycled paper).

Solution: Load unused plain white letter or A4 paper into the input tray, and then try the alignment again.

If the alignment fails again, you might have a defective sensor on the print head assembly. Contact HP support. Go to www.hp.com/support. If prompted, choose your country/region, and then click **Contact HP** for information on calling for technical support.

For more information, see:

[“Align the printer” on page 102](#)

The HP All-in-One does not print

Cause: The HP All-in-One and computer are not communicating with each other.

Solution: Check the connection between the HP All-in-One and computer.

For more information, see:

[“Communication problems over a USB connection” on page 109](#)

Cause: There might be a problem with one or more of the ink cartridges.

Solution: Check that the ink cartridges are installed properly and have ink.

For more information, see:

[“Work with ink cartridges” on page 99](#)

Cause: The HP All-in-One might not be turned on.

Solution: Look at the display on the HP All-in-One. If the display is blank and the **On** button is not lit, the HP All-in-One is turned off. Make sure the power cord is firmly connected to the HP All-in-One and plugged into a power outlet. Press the **On** button to turn on the HP All-in-One.

Cause: The HP All-in-One might be out of paper.

Solution: Load paper in the input tray.

For more information, see:

[“Load paper” on page 36](#)

I received a message on the display about a paper jam or a blocked print head assembly

Cause: The HP All-in-One has a paper jam.

Solution: Clear the paper jam, and then follow the prompts on the display or the computer screen to continue.

For more information, see:

[“Clear paper jams” on page 111](#)

Cause: The print head assembly is blocked.

Solution: There might be some packing material inside the HP All-in-One. Turn the HP All-in-One off and open the ink cartridge door. Remove any objects that are blocking the print head assembly (including any packing materials), and then turn the HP All-in-One on again. Follow the prompts on the display or the computer screen to continue.

Software installation troubleshooting

Use this section to solve any problems you might encounter while setting up the HP All-in-One software.

This section contains the following topics:

- [When I insert the CD-ROM into my computer’s CD-ROM drive, nothing happens](#)
- [The minimum system checks screen appears](#)
- [A red X appears on the USB connect prompt](#)
- [I received a message that an unknown error has occurred](#)
- [The registration screen does not appear](#)
- [Uninstall and reinstall the software](#)
- [Missing HP Photosmart Software](#)

When I insert the CD-ROM into my computer’s CD-ROM drive, nothing happens

Cause: The installation failed to run automatically.

Solution: If the installation does not run automatically, you can start it manually.

To start the installation from a Windows computer

1. From the Windows **Start** menu, click **Run**.
 2. In the **Run** dialog box, enter **d:\setup.exe**, and then click **OK**.
If your CD-ROM drive is not assigned to drive letter D, enter the appropriate drive letter.
-

The minimum system checks screen appears

Cause: Your system does not meet the minimum requirements to install the software.

Solution: Click **Details** to see what the specific problem is, and then correct the problem before attempting to install the software.

A red X appears on the USB connect prompt

Cause: Normally, a green check appears indicating that the USB connection is successful. A red X indicates that the USB connection failed.

Solution: Check that the HP All-in-One is turned on, and then try the USB connection again.

To retry the USB connection

1. Unplug the HP All-in-One power cord, and then plug it in again.
2. Verify that the USB cable and power cord are plugged in.

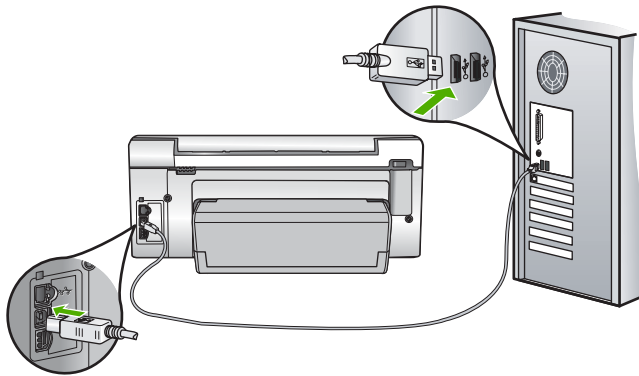

3. Click **Retry** to retry the connection. If this does not work, continue to the next step.
4. Verify that the USB cable is set up properly as follows:
 - Unplug the USB cable and plug it in again or try plugging the USB cable into a different USB port.
 - Do not attach the USB cable to a keyboard.
 - Verify that the USB cable is 3 meters (9.8 feet) or less in length.
 - If you have several USB devices attached to your computer, you might want to unplug the other devices during the installation.
5. Continue with the installation and restart the computer when prompted.

For more information, see:

[“Uninstall and reinstall the software” on page 118](#)

I received a message that an unknown error has occurred

Cause: The source of the error is unknown.

Solution: Try to continue with the installation. If that does not work, stop and then restart the installation, and follow the directions on the screen. If an error occurs, you might need to uninstall and then reinstall the software. Do not simply delete the HP All-

in-One application files from your computer. Make sure to remove them properly using the uninstall utility provided when you installed the software that came with the HP All-in-One.

For more information, see:

[“Uninstall and reinstall the software” on page 118](#)

The registration screen does not appear

Cause: The registration screen did not launch automatically.

Solution: You can access the registration (Sign up now) screen from the Windows taskbar by clicking **Start**, pointing to **Programs** or **All Programs**, **HP, Photosmart C6200 All-in-One series**, and then clicking **Product Registration**.

Uninstall and reinstall the software

If your installation is incomplete, or if you connected the USB cable to the computer before prompted by the software installation screen, you might need to uninstall and then reinstall the software. Do not simply delete the HP All-in-One application files from your computer. Make sure to remove them properly using the uninstall utility provided when you installed the software that came with the HP All-in-One.

To uninstall from a Windows computer, method 1

1. Disconnect the HP All-in-One from your computer. Do not connect the HP All-in-One to your computer until after you have reinstalled the software.
2. On the Windows taskbar, click **Start**, **Programs** or **All Programs**, **HP, Photosmart C6200 All-in-One series**, **Uninstall**.
3. Follow the onscreen instructions.
4. If you are asked whether you would like to remove shared files, click **No**. Other programs that use these files might not work properly if the files are deleted.
5. Restart your computer.



NOTE: It is important that you disconnect the HP All-in-One before restarting your computer. Do not connect the HP All-in-One to your computer until after you have reinstalled the software.

6. To reinstall the software, insert the HP All-in-One CD-ROM into your computer's CD-ROM drive, and follow the onscreen instructions and the instructions provided in the Setup Guide that came with the HP All-in-One.
7. After the software is installed, connect the HP All-in-One to your computer.
8. Press the **On** button to turn the HP All-in-One on.
After connecting and turning on the HP All-in-One, you might have to wait several minutes for all of the Plug and Play events to complete.
9. Follow the onscreen instructions.

To uninstall from a Windows computer, method 2

 **NOTE:** Use this method if **Uninstall** is not available in the Windows Start menu.

1. On the Windows taskbar, click **Start, Settings, Control Panel**.
2. Double-click **Add/Remove Programs**.
3. Select **HP Photosmart All-In-One Driver Software**, and then click **Change/Remove**.

Follow the onscreen instructions.

4. Disconnect the HP All-in-One from your computer.
 5. Restart your computer.
-

 **NOTE:** It is important that you disconnect the HP All-in-One before restarting your computer. Do not connect the HP All-in-One to your computer until after you have reinstalled the software.

6. Insert the HP All-in-One CD-ROM into your computer's CD-ROM drive and then start the Setup program.
7. Follow the onscreen instructions and the instructions provided in the Setup Guide that came with the HP All-in-One.

To uninstall from a Windows computer, method 3

 **NOTE:** Use this method if **Uninstall** is not available in the Windows Start menu.

1. Insert the HP All-in-One CD-ROM into your computer's CD-ROM drive and then start the Setup program.
 2. Disconnect the HP All-in-One from your computer.
 3. Select **Uninstall** and follow the onscreen directions.
 4. Restart your computer.
-

 **NOTE:** It is important that you disconnect the HP All-in-One before restarting your computer. Do not connect the HP All-in-One to your computer until after you have reinstalled the software.

5. Start the Setup program for the HP All-in-One again.
6. Select **Install**.
7. Follow the onscreen instructions and the instructions provided in the Setup Guide that came with the HP All-in-One.

Missing HP Photosmart Software

Cause: The HP Photosmart Software is not installed.

Solution: Install the HP Photosmart Software that came with the HP All-in-One. If it is installed, restart your computer.

To install the HP Photosmart Software

1. Insert the HP All-in-One CD-ROM into your computer's CD-ROM drive and then start the Setup program.
2. When prompted, click **Install More Software** to install the HP Photosmart Software.
3. Follow the onscreen instructions and the instructions provided in the Setup Guide that came with the HP All-in-One.

Cause: The HP All-in-One is turned off.

Solution: Turn the HP All-in-One on.

Cause: The computer is turned off.

Solution: Turn the computer on.

Cause: The HP All-in-One is not properly connected to the computer.

Solution: Check the connection from the HP All-in-One to your computer. Verify that the USB cable is securely plugged into the USB port on the back of the HP All-in-One. Make sure the other end of the USB cable is plugged into a USB port on your computer. After the cable is connected properly, turn the HP All-in-One off and then on again.

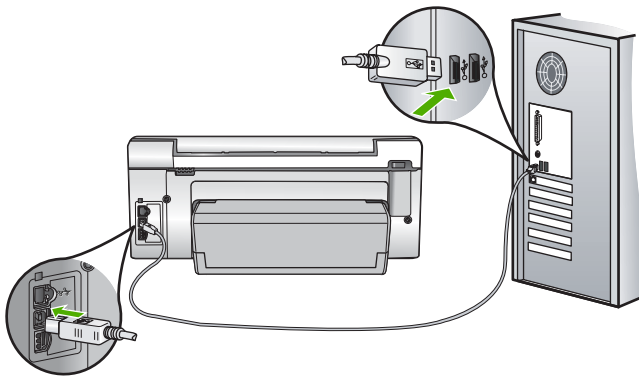

For more information on setting up the HP All-in-One and connecting it to your computer, see the Setup Guide that came with the HP All-in-One.

Network troubleshooting

This section addresses problems you might encounter setting up a wired network.

This section contains the following topics:

- [The computer is unable to discover the HP All-in-One](#)
- [The Printer not Found screen appears during installation](#)

The computer is unable to discover the HP All-in-One

Cause: Cables are not connected properly.

Solution: Check the following cables to ensure they are connected properly.

- Cables between the HP All-in-One and the hub or router
- Cables between the hub or router and your computer
- Cables to and from your modem or HP All-in-One Internet connection (if applicable)

Cause: Your computer's Local Area Network card (LAN card) is not set up properly.

Solution: Make sure that your LAN card is set up properly.

To check your LAN card (Windows 2000 and XP)

1. Right-click **My Computer**.
2. In the **System Properties** dialog box, click the **Hardware** tab.
3. Click **Device Manager**.
4. Make sure your card shows up under **Network Adapters**.
5. Refer to the documentation that came with your card.

To check your LAN card (Windows Vista)

1. On the Windows taskbar, click **Start, Computer**, and then click **Properties**.
2. Click **Device Manager**.
3. Make sure your card shows up under **Network Adapters**.
4. Refer to the documentation that came with your card.

Cause: You do not have an active network connection.

Solution: Check to see if you have an active network connection.

To see if you have an active network connection

- ▲ Check the two Ethernet indicator lights on the top and bottom of the RJ-45 Ethernet jack on the back of the HP All-in-One. The lights indicate the following:
 - a. Top light: If this light is a solid green, the device is properly connected to the network, and communications have been established. If the top light is off, there is no network connection.
 - b. Bottom light: This yellow light flashes when data is being sent or received by the device over the network.

To establish an active network connection

1. Check the cable connections from the HP All-in-One to your gateway, router, or hub to ensure connections are secure.
2. If the connections are secure, press the **On** button on the control panel to turn the HP All-in-One off. Then turn off the power on your router or hub. Turn on the router or hub first, and then press the **On** button to turn the HP All-in-One on.

Cause: You were able to connect the HP All-in-One to the network previously, but now it will not connect.

Solution: Turn off the HP All-in-One, the computer, and the router. Wait a few seconds. Turn on the router first, and then turn on the HP All-in-One and the computer.

Cause: The HP All-in-One and computer are not connected to the same network.

Solution: Try accessing the Embedded Web Server on the HP All-in-One. To find the IP address, print a network configuration page.

Related topics

- [“View and print network settings” on page 23](#)
- [“Use the Embedded Web Server” on page 25](#)

The Printer not Found screen appears during installation

Cause: The HP All-in-One is not turned on.

Solution: Turn on the HP All-in-One.

Cause: You do not have an active network connection.

Solution: Make sure you have an active network connection.

To make sure your network connection is active

1. If the connections are secure, turn off the power on the HP All-in-One, and then turn it on again. Press the **On** button on the control panel to turn the HP All-in-One off, and press it again to turn the device on. Also, turn off the power on your router or hub, and then turn it on again.
2. Check the cable connections from the HP All-in-One to your gateway, router, or hub to ensure connections are secure.
3. Make sure the HP All-in-One is connected to the network with a CAT-5 Ethernet cable.

Cause: Cables are not connected properly.

Solution: Check the following cables to ensure they are connected properly:

- Cables between the HP All-in-One and the hub or router
- Cables between the hub or router and your computer
- Cables to and from your modem or HP All-in-One Internet connection (if applicable)

Cause: A firewall, anti-virus, or anti-spyware application is preventing the HP All-in-One from accessing your computer.

Solution: Uninstall the HP All-in-One software, and then reboot your computer. Temporarily disable anti-virus or anti-spyware applications, and then reinstall the HP All-in-One software. You can re-enable your anti-virus or anti-spyware applications after installation is complete. If you see firewall pop-up messages, you must always accept or allow the pop-up messages.

If the screen still appears, try uninstalling the HP All-in-One software, rebooting your computer, and temporarily disabling your firewall before reinstalling the HP All-in-One software. You can re-enable your firewall application after installation is complete. If you still see firewall pop-up messages, you must always accept or allow the pop-up messages.

For more information, see the documentation provided with the firewall software.

Cause: A Virtual Private Network (VPN) is preventing the HP All-in-One from accessing your computer.

Solution: Try temporarily disabling the VPN before proceeding with the installation.

 **NOTE:** The HP All-in-One functionality will be limited during VPN sessions.

Print quality troubleshooting

If you are having problems with print quality, try the solutions in this section and observe the following guidelines:

- To achieve the best print quality, HP recommends using HP papers that are specifically designed for the type of project you are printing along with genuine HP ink. HP papers and HP ink are specifically designed to work well together to provide high-quality output.
- Replace refilled or empty ink cartridges with genuine HP ink cartridges.
- Check the device settings to make sure that the print mode and paper selection is correct for the paper and the task.

For more information, see [“Set the paper type for printing” on page 47](#) and [“Choose papers for printing and copying” on page 34](#).

- Print and evaluate a self-test report.
For more information, see [“Print a self-test report” on page 95](#).

If the self-test report shows a defect, try the following:

- Clean the ink cartridges automatically. For more information, see [“Clean the print head” on page 103](#).
- If you are missing lines when you print, clean the electrical contacts. For more information, see [“Clean the ink cartridge contacts” on page 104](#).
- If the self-test report does not show a problem, investigate other causes, such as the image file or software program.

For additional ink cartridge troubleshooting, visit the HP Web site at www.hp.com/support.

This section contains the following topics:

- [Ink is bleeding or smearing](#)
- [Ink is not filling the text or graphics completely](#)
- [The text edges are jagged](#)
- [The printout has a horizontal band of distortion near the bottom of the page](#)
- [Colors run into each other on the printout](#)
- [Printouts have horizontal streaks or lines](#)
- [Printouts are faded or have dull colors](#)
- [Printouts seem blurry or fuzzy](#)
- [Printouts have vertical streaks](#)
- [Printouts are slanted or skewed](#)
- [Ink is overspraying the paper when I print a photo](#)
- [Paper is not picked up from the input tray](#)

Ink is bleeding or smearing

Cause: The paper type is not suitable for the HP All-in-One.

Solution: Use HP Premium Papers or any other paper type that is appropriate for the HP All-in-One.

Cause: The print head needs to be cleaned.

Solution: Clean the print head, and then print a self-test report. Check the color blocks in the report for any problems. If the color blocks show print quality problems, perform a printer alignment.

If the problem persists after cleaning and aligning, contact HP support for help. Go to:

www.hp.com/support

If prompted, choose your country/region, and then click **Contact HP** for information on calling for technical support.

For more information, see:

- [“Clean the print head” on page 103](#)
- [“Print a self-test report” on page 95](#)
- [“Align the printer” on page 102](#)

Cause: The paper is too close to the print head.

Solution: If the paper is too close to the print head during printing, the ink might be smeared. This can happen if the paper is raised, wrinkled, or very thick, such as a mailing envelope. Make sure the paper lays flat in the input tray and is not wrinkled.

Ink is not filling the text or graphics completely

Cause: The **Paper Type** setting is incorrect.

Solution: Change the **Paper Type** setting to match the type of paper loaded in the input tray.

For more information, see:

- [“Set the copy paper type” on page 87](#)
 - [“Set the paper type for printing” on page 47](#)
-

Cause: The print quality setting on the HP All-in-One is set too low.

Solution: Load high-quality paper in the input tray and print the image with a high print quality setting, such as **Best**, **Maximum dpi**, or **High Resolution**. Always make sure the paper you are printing on is flat. For best results when printing images, use HP Premium Plus Photo Paper.

If the problem persists, use the software you installed with the HP All-in-One or another software application to rotate your image 180 degrees so that the light blue, gray, or brown hues in your image do not print at the bottom of the page.

For more information, see:

[“Information on paper” on page 111](#)

Cause: The print head needs to be cleaned.

Solution: Clean the print head, and then print a self-test report. Check the color blocks in the report for any problems. If the color blocks show print quality problems, perform a printer alignment.

If the problem persists after cleaning and aligning, contact HP support for help. Go to:

www.hp.com/support

If prompted, choose your country/region, and then click **Contact HP** for information on calling for technical support.

For more information, see:

- [“Clean the print head” on page 103](#)
 - [“Print a self-test report” on page 95](#)
 - [“Align the printer” on page 102](#)
-

Cause: You are using non-HP ink.

Solution: HP recommends that you use genuine HP ink cartridges. Genuine HP ink cartridges are designed and tested with HP printers to help you easily produce great results, time after time.



NOTE: HP cannot guarantee the quality or reliability of non-HP ink. Printer service or repairs required as a result of printer failure or damage attributable to the use of non-HP ink will not be covered under warranty.

The text edges are jagged

Cause: The font is a custom size.

Solution: Some software applications offer custom fonts that have jagged edges when enlarged or printed. Also, if you want to print bitmapped text, it might have jagged edges when enlarged or printed.

Use TrueType or OpenType fonts to ensure that the HP All-in-One is able to print smooth fonts. When selecting a font, look for the TrueType or OpenType icon.

The printout has a horizontal band of distortion near the bottom of the page

Cause: Your photo image has light blue, gray, or brown hues that print near the bottom of the page.

Solution: Load high-quality paper in the input tray and print the image with a high print quality setting, such as **Best**, **Maximum dpi**, or **High Resolution**. Always make sure the paper you are printing on is flat. For best results when printing images, use HP Premium Plus Photo Paper.

If the problem persists, use the software you installed with the HP All-in-One or another software application to rotate your image 180 degrees so that the light blue, gray, or brown hues in your image do not print at the bottom of the page.

For more information, see:

[“Information on paper” on page 111](#)

Colors run into each other on the printout

Cause: The print or copy quality setting is set too high for the type of paper loaded in the HP All-in-One.

Solution: Check the quality setting. Use a lower quality setting to decrease the amount of ink used for printing or copying.

For more information, see:

- [“Change the print speed or quality” on page 48](#)
 - [“Change copy speed or quality” on page 88](#)
-

Cause: The paper type is not suitable for the HP All-in-One.

Solution: Use HP Premium Papers or any other paper type that is appropriate for the HP All-in-One.

Cause: You are printing on the wrong side of the paper.

Solution: Load paper with the side you want to print on facing down. For example, if you are loading glossy photo paper, load the paper with the glossy side down.

For more information, see:

[“Load paper” on page 36](#)

Cause: You are using non-HP ink.

Solution: HP recommends that you use genuine HP ink cartridges. Genuine HP ink cartridges are designed and tested with HP printers to help you easily produce great results, time after time.

 **NOTE:** HP cannot guarantee the quality or reliability of non-HP ink. Printer service or repairs required as a result of printer failure or damage attributable to the use of non-HP ink will not be covered under warranty.

Cause: The print head needs to be cleaned.

Solution: Clean the print head, and then print a self-test report. Check the color blocks in the report for any problems. If the color blocks show print quality problems, perform a printer alignment.

If the problem persists after cleaning and aligning, contact HP support for help. Go to:

www.hp.com/support

If prompted, choose your country/region, and then click **Contact HP** for information on calling for technical support.

For more information, see:

- [“Clean the print head” on page 103](#)
 - [“Print a self-test report” on page 95](#)
 - [“Align the printer” on page 102](#)
-

Printouts have horizontal streaks or lines

Cause: The paper is not feeding properly or is loaded incorrectly.

Solution: Make sure the paper is loaded correctly.

For more information, see:

[“Load full-size paper” on page 37](#)

Cause: The print quality setting on the HP All-in-One is set too low.

Solution: Load high-quality paper in the input tray and print the image with a high print quality setting, such as **Best**, **Maximum dpi**, or **High Resolution**. Always make sure the paper you are printing on is flat. For best results when printing images, use HP Premium Plus Photo Paper.

If the problem persists, use the software you installed with the HP All-in-One or another software application to rotate your image 180 degrees so that the light blue, gray, or brown hues in your image do not print at the bottom of the page.

For more information, see:

[“Information on paper” on page 111](#)

Cause: The print head needs to be cleaned.

Solution: Clean the print head, and then print a self-test report. Check the color blocks in the report for any problems. If the color blocks show print quality problems, perform a printer alignment.

If the problem persists after cleaning and aligning, contact HP support for help. Go to:

www.hp.com/support

If prompted, choose your country/region, and then click **Contact HP** for information on calling for technical support.

For more information, see:

- [“Clean the print head” on page 103](#)
 - [“Print a self-test report” on page 95](#)
 - [“Align the printer” on page 102](#)
-

Printouts are faded or have dull colors

Cause: The print quality setting on the HP All-in-One is set too low.

Solution: Load high-quality paper in the input tray and print the image with a high print quality setting, such as **Best**, **Maximum dpi**, or **High Resolution**. Always make sure the paper you are printing on is flat. For best results when printing images, use HP Premium Plus Photo Paper.

If the problem persists, use the software you installed with the HP All-in-One or another software application to rotate your image 180 degrees so that the light blue, gray, or brown hues in your image do not print at the bottom of the page.

For more information, see:

[“Information on paper” on page 111](#)

Cause: The paper type is not suitable for the HP All-in-One.

Solution: Use HP Premium Papers or any other paper type that is appropriate for the HP All-in-One.

Cause: The **Lighter/Darker** copy setting for the HP All-in-One is set too light.

Solution: Adjust the lightness and darkness of the copies.

For more information, see:

[“Adjust the lightness and darkness of your copy” on page 89](#)

Cause: The **Paper Type** setting is incorrect.

Solution: Change the **Paper Type** setting to match the type of paper loaded in the input tray.

For more information, see:

- [“Set the copy paper type” on page 87](#)
- [“Set the paper type for printing” on page 47](#)

Cause: Copying a poor-quality picture, such as a newspaper photo, causes bands, checks, or stripes to appear on your copy. These are called moiré patterns.

Solution: To reduce moiré patterns, try placing one or more clear plastic sheet protectors directly on the glass, and then place the original print side down on top of the sheet protectors.

Cause: Debris might be stuck on the glass or on the back of the document lid; this causes poor copy quality and slows down processing.

Solution: Clean the glass and the back of the document lid.

For more information, see:

- [“Clean the glass” on page 97](#)
- [“Clean the lid backing” on page 98](#)

Cause: The print head needs to be cleaned.

Solution: Clean the print head, and then print a self-test report. Check the color blocks in the report for any problems. If the color blocks show print quality problems, perform a printer alignment.

If the problem persists after cleaning and aligning, contact HP support for help. Go to:

www.hp.com/support

If prompted, choose your country/region, and then click **Contact HP** for information on calling for technical support.

For more information, see:

- [“Clean the print head” on page 103](#)
- [“Print a self-test report” on page 95](#)
- [“Align the printer” on page 102](#)

Printouts seem blurry or fuzzy

Cause: The paper type is not suitable for the HP All-in-One.

Solution: Use HP Premium Papers or any other paper type that is appropriate for the HP All-in-One.

Cause: The **Paper Type** setting is incorrect.

Solution: Change the **Paper Type** setting to match the type of paper loaded in the input tray.

For more information, see:

- [“Set the copy paper type” on page 87](#)
- [“Set the paper type for printing” on page 47](#)

Cause: The print quality setting on the HP All-in-One is set too low.

Solution: Load high-quality paper in the input tray and print the image with a high print quality setting, such as **Best**, **Maximum dpi**, or **High Resolution**. Always make sure the paper you are printing on is flat. For best results when printing images, use HP Premium Plus Photo Paper.

If the problem persists, use the software you installed with the HP All-in-One or another software application to rotate your image 180 degrees so that the light blue, gray, or brown hues in your image do not print at the bottom of the page.

For more information, see:

[“Information on paper” on page 111](#)

Cause: You are printing on the wrong side of the paper.

Solution: Load paper with the side you want to print on facing down. For example, if you are loading glossy photo paper, load the paper with the glossy side down.

For more information, see:

[“Load paper” on page 36](#)

Printouts have vertical streaks

Cause: The paper type is not suitable for the HP All-in-One.

Solution: Use HP Premium Papers or any other paper type that is appropriate for the HP All-in-One.

Printouts are slanted or skewed

Cause: The paper is not feeding properly or is loaded incorrectly.

Solution: Make sure the paper is loaded correctly.

For more information, see:

[“Load full-size paper” on page 37](#)

Cause: More than one type of paper is loaded in the input tray.

Solution: Load only one type of paper at a time.

Cause: The Two-sided printing accessory might not be securely installed.

Solution: Make sure the Two-sided printing accessory on the back of the HP All-in-One is securely installed.

Ink is overspraying the paper when I print a photo

Cause: A small amount (a few millimeters) of overspray is common when making a copy of a photo. If there are more than a few millimeters of overspray, it might mean the HP All-in-One thinks the paper loaded is wider than it actually is.

 **TIP:** One way to tell if ink is overspraying the paper is to check the back side of pages you print after running a copy or print job. If the back side of the page has ink streaks, the HP All-in-One might have over sprayed your previous copy or print job.

Solution: Check the paper size setting. Set the paper size to match the paper loaded in the input tray.

For more information, see:

[“Set the copy paper size” on page 86](#)

Paper is not picked up from the input tray

Cause: There is not enough paper in the input tray.

Solution: If the HP All-in-One is out of paper or there are only a few sheets remaining, load more paper in the input tray. If there is paper in the input tray, remove the paper, tap the stack of paper against a flat surface, and reload the paper into the input tray. Follow the prompts on the display or the computer screen to continue your print job.

Print troubleshooting

Use this section to solve these printing problems:

- [Envelopes print incorrectly](#)
- [Borderless printing produces unexpected results](#)
- [The HP All-in-One is not responding](#)
- [The HP All-in-One prints meaningless characters](#)
- [Nothing happens when I try to print](#)
- [The pages in my document came out in the wrong order](#)
- [The margins are not printing as expected](#)
- [Text or graphics are cut off at the edge of the page](#)
- [A blank page came out while printing](#)
- [Ink is spraying the inside of the HP All-in-One when I print a photo](#)

Envelopes print incorrectly

Cause: A stack of envelopes is loaded incorrectly.

Solution: Remove all paper from the input tray. Load a stack of envelopes in the input tray, with the envelope flaps facing up and to the left.

 **NOTE:** To avoid paper jams, tuck the flaps inside the envelopes.

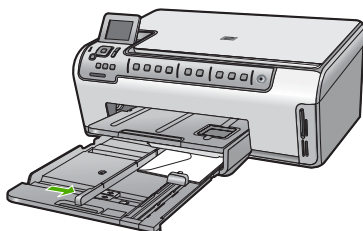

Related topics

[“Load envelopes” on page 40](#)

Cause: The wrong type of envelope is loaded.

Solution: Do not use shiny or embossed envelopes or envelopes that have clasps or windows.

Borderless printing produces unexpected results

Cause: Printing a borderless image from a non-HP software application produces unexpected results.

Solution: Try printing the image from the photo imaging software that came with the HP All-in-One.

The HP All-in-One is not responding

Cause: The HP All-in-One is busy with another task.

Solution: If the HP All-in-One is performing another task such as copying or scanning, your print job will be delayed until the HP All-in-One completes the current task.

Some documents take a long time to print. If nothing has printed several minutes after you sent a print job to the HP All-in-One, check your computer to see if there are any messages.

Cause: The HP All-in-One has a paper jam.

Solution: Clear the paper jam.

For more information, see:

[“Clear paper jams” on page 111](#)

Cause: The HP All-in-One is out of paper.

Solution: Load paper in the input tray.

For more information, see:

[“Load paper” on page 36](#)

Cause: The print head assembly has stalled.

Solution: Turn the HP All-in-One off and open the ink cartridge door. Remove any objects that are blocking the print head assembly (including any packing materials), and then turn the HP All-in-One on again.

Cause: The computer is not communicating with the HP All-in-One.

Solution: If the HP All-in-One is not properly connected to the computer, communication errors can occur. Make sure the USB cable is connected to the HP All-in-One and the computer as shown below.

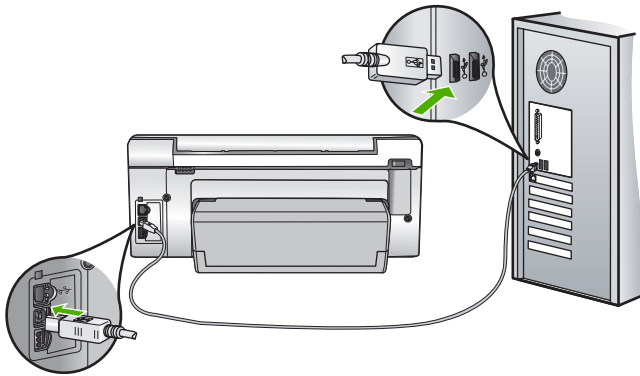

If the connections are secure, and nothing has printed several minutes after you sent a print job to the HP All-in-One, check the status of the HP All-in-One. In the HP Photosmart Software, click **Status**.

For more information, see:

[“Communication problems over a USB connection” on page 109](#)

Cause: The HP All-in-One is turned off.

Solution: Look at the **On** button located on the top of the HP All-in-One. If it is not lit, the HP All-in-One is turned off. Make sure the power cord is firmly connected to the HP All-in-One and plugged into a power outlet. Press the **On** button to turn on the HP All-in-One.

Cause: The HP All-in-One experienced an error.

Solution: Turn the HP All-in-One off, and then unplug the power cord. Plug the power cord back in, and then press the **On** button to turn on the HP All-in-One.

Cause: The status of the printer driver has changed.

Solution: The printer driver status might have changed to either **offline** or **stop printing**.

To check the printer driver status

1. In the HP Solution Center, click the device tab.
2. Click **Settings**.
3. Click **Status**.

If the status is **offline** or **stop printing**, change the status to **ready**.

Cause: A deleted print job is still in the queue.

Solution: A print job might remain in the queue after it has been cancelled. The cancelled print job jams the queue and prevents the next print job from printing.

From your computer, open the printer folder and see if the cancelled job remains in the print queue. Try to delete the job from the queue. If the print job remains in the queue, try one or both of the following:

- Disconnect the USB cable from the HP All-in-One, restart the computer, and then reconnect the USB cable to the HP All-in-One.
 - Shut down the HP All-in-One, restart the computer, and then restart the HP All-in-One.
-

Cause: The Two-sided printing accessory is not installed correctly.

Solution: If the Two-sided printing accessory is installed, remove it and reinstall it. To reinstall it, press the buttons on each side of the accessory and push it into the rear of the HP All-in-One until it clicks into place.

If the Two-sided printing accessory is not installed, install it at the rear of the HP All-in-One.

The HP All-in-One prints meaningless characters

Cause: There is no more available memory in the HP All-in-One.

Solution: Turn off the HP All-in-One and your computer for 60 seconds, then turn them both on and try printing again.

Cause: The document is corrupt.

Solution: Try printing another document from the same software application. If this works, then try printing a previously saved version of the document that is not corrupt.

Nothing happens when I try to print

Cause: The HP All-in-One is turned off.

Solution: Look at the **On** button located on the top of the HP All-in-One. If it is not lit, the HP All-in-One is turned off. Make sure the power cord is firmly connected to

the HP All-in-One and plugged into a power outlet. Press the **On** button to turn on the HP All-in-One.

Cause: The HP All-in-One is busy with another task.

Solution: If the HP All-in-One is performing another task such as copying or scanning, your print job will be delayed until the HP All-in-One completes the current task.

Some documents take a long time to print. If nothing has printed several minutes after you sent a print job to the HP All-in-One, check your computer to see if there are any messages.

Cause: The HP All-in-One is not the selected printer.

Solution: Make sure the HP All-in-One is the selected printer in your software application.

 **TIP:** You can set the HP All-in-One as the default printer to ensure that the printer is automatically selected when you select **Print** in the **File** menu of your different software applications.

Cause: The computer is not communicating with the HP All-in-One.

Solution: If the HP All-in-One is not properly connected to the computer, communication errors can occur. Make sure the USB cable is connected to the HP All-in-One and the computer as shown below.

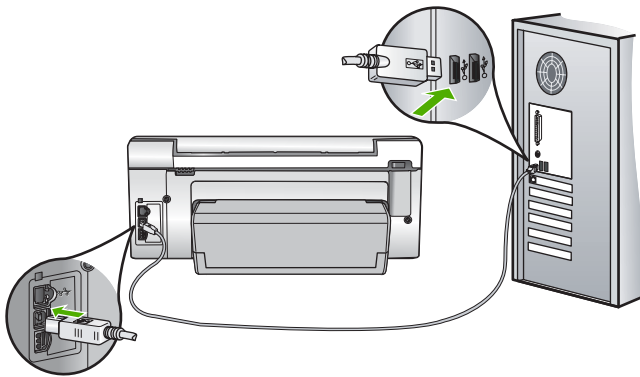

If the connections are secure, and nothing has printed several minutes after you sent a print job to the HP All-in-One, check the status of the HP All-in-One. In the HP Photosmart Software, click **Status**.

For more information, see:

[“Communication problems over a USB connection” on page 109](#)

Cause: The HP All-in-One has a paper jam.

Solution: Clear the paper jam.

For more information, see:

[“Clear paper jams” on page 111](#)

Cause: The print head assembly has stalled.

Solution: Turn the HP All-in-One off and open the ink cartridge door. Remove any objects that are blocking the print head assembly (including any packing materials), and then turn the HP All-in-One on again.

Cause: The HP All-in-One is out of paper.

Solution: Load paper in the input tray.

For more information, see:

[“Load paper” on page 36](#)

The pages in my document came out in the wrong order

Cause: The print settings are set to print the first page of your document first. Because of the way the paper feeds through the HP All-in-One, this means the first page will be print side up at the bottom of the stack.

Solution: Print the document in reverse order. When the document finishes printing, the pages will be in correct order.

For more information, see:

[“Print a multiple-page document in reverse order” on page 58](#)

The margins are not printing as expected

Cause: The margins are not set correctly in your software application.

Solution: Check the printer margins.

Make sure the margin settings for the document do not exceed the printable area of the HP All-in-One.

To check your margin settings

1. Preview your print job before sending it to the HP All-in-One.
 2. Check the margins.
The HP All-in-One uses the margins you have set in your software application, as long as they are greater than the minimum margins the HP All-in-One supports.
 3. Cancel the print job if the margins are not satisfactory, and then adjust the margins in your software application.
-

Cause: The paper size setting might not be set correctly for the project you are printing.

Solution: Verify that you have selected the proper paper size setting for your project. Make sure that you have loaded the correct paper size in the input tray.

Cause: The paper guides are not positioned correctly.

Solution: Remove the stack of paper from the input tray, reload the paper, and then slide the paper width guide inward until it stops at the edge of the paper.

For more information, see:

[“Load paper” on page 36](#)

Cause: A stack of envelopes is loaded incorrectly.

Solution: Remove all paper from the input tray. Load a stack of envelopes in the input tray, with the envelope flaps facing up and on the left.

 **NOTE:** To avoid paper jams, tuck the flaps inside the envelopes.

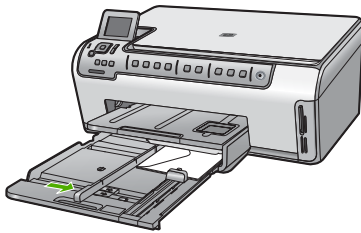

For more information, see:

[“Load envelopes” on page 40](#)

Text or graphics are cut off at the edge of the page

Cause: The margins are not set correctly in your software application.

Solution:

To check your margin settings

1. Preview your print job before sending it to the HP All-in-One.
2. Check the margins.
The HP All-in-One uses the margins you have set in your software application, as long as they are greater than the minimum margins the HP All-in-One supports.
3. Cancel the print job if the margins are not satisfactory, and then adjust the margins in your software application.

Make sure the margin settings for the document do not exceed the printable area of the HP All-in-One.

Cause: The size of the document you are printing is larger than the paper loaded in the input tray.

Solution: Make sure the layout of the document you are trying to print fits on a paper size supported by the HP All-in-One.

To preview the print layout

1. Load the correct paper size into the input tray.
2. Preview your print job before sending it to the HP All-in-One.
3. Check the graphics in the document to make sure that the current size fits within the printable area of the HP All-in-One.
4. Cancel the print job if the graphics do not fit in the printable area of the page.

 **TIP:** Some software applications allow you to scale the document to fit the paper size currently selected. Additionally, you can scale the size of a document from the print **Properties** dialog box.

Cause: The paper is loaded incorrectly.

Solution: If the paper is misfeeding, it could cause parts of the document to cut off.

Remove the stack of paper from the input tray, and then reload the paper following the steps below.

For more information, see:

[“Load paper” on page 36](#)

A blank page came out while printing

Cause: The document you are printing contains an additional blank page.

Solution: Open the document file in your software application and remove any extra pages or lines at the end of the document.

Cause: The HP All-in-One picked up two sheets of paper.

Solution: If the HP All-in-One has only a few sheets remaining, load more paper in the input tray. If there is plenty of paper in the input tray, remove the paper, tap the stack of paper against a flat surface, and reload the paper into the input tray.

For more information, see:

[“Load paper” on page 36](#)

Ink is spraying the inside of the HP All-in-One when I print a photo

Cause: The borderless print settings require photo paper to be loaded in the input tray. You are using the wrong paper type.

Solution: Make sure you load photo paper in the input tray before you print a borderless print job.

Memory card troubleshooting

Use this section to solve these memory card problems:

- [My memory card no longer works in my digital camera](#)
- [The HP All-in-One does not read the memory card](#)
- [The Photo light next to the memory card slots is blinking](#)
- [The Attention light blinks when I insert my memory card](#)
- [The photos on the memory card do not transfer to my computer](#)
- [Memory card is not available](#)
- [The file name appears as meaningless text](#)
- [Other users on the network can access my memory card](#)
- [Error message: Cannot find the file or item. Make sure the path and file name are correct.](#)

My memory card no longer works in my digital camera

Cause: You formatted the card on a Windows XP computer. By default, Windows XP will format a memory card of 8 MB or less and 64 MB or more with the FAT32 format. Digital cameras and other devices use the FAT (FAT16 or FAT12) format and cannot recognize a FAT32 formatted card.

Solution: Reformat your memory card in your camera or format your memory card in a Windows XP computer by selecting the FAT format.

The HP All-in-One does not read the memory card

Cause: The card is inserted backwards or upside down.

Solution: Turn the memory card so that the label side is on the left and the contacts are on the right (and facing the HP All-in-One), and then push the card forward into the appropriate slot until the Photo light turns on.

If the memory card is not inserted properly, the HP All-in-One will not respond and the Photo light (near the memory card slots) will not turn on.

After the memory card has been inserted properly, the Photo light will blink for a few seconds, and then remain lit.

Cause: The memory card is not fully inserted.

Solution: Make sure you fully insert the memory card into the appropriate slot on the HP All-in-One.

If the memory card is not inserted properly, the HP All-in-One will not respond and the Photo light (near the memory card slots) will not turn on.

After a memory card has been inserted properly, the Photo light will blink for a few seconds, and then remain lit.

Cause: You have inserted more than one memory card.

Solution: Remove one of the memory cards. You can use only one memory card at a time.

Cause: The file system is corrupted.

Solution: Check the display for an error message telling you about the problem and how to solve it.

If the file system on the card is corrupt, reformat the memory card in your digital camera.

△ **CAUTION:** Reformatting the memory card will delete any photos stored on the card. If you have previously transferred the photos from your memory card to a computer, try printing the photos from the computer. Otherwise, you will need to retake any photos you might have lost.

The Photo light next to the memory card slots is blinking

Cause: The HP All-in-One is reading the memory card.

Solution: Do not pull out the memory card while the Photo light is flashing. A flashing light means the HP All-in-One is accessing the memory card. Wait until the light remains solid. Removing a memory card while it is being accessed might corrupt information on the card or damage the HP All-in-One and card.

The Attention light blinks when I insert my memory card

Cause: The HP All-in-One has detected an error with the memory card.

Solution: Remove and reinsert the memory card. You might have inserted it incorrectly. Turn the memory card so that the label side is on the left and the contacts are on the right (and pointing towards the HP All-in-One), and then push the card forward into the appropriate slot until the Photo light turns on.

If the problem continues, the memory card might be defective.

Cause: You have inserted more than one memory card.

Solution: Remove one of the memory cards. You can use only one memory card at a time.

The photos on the memory card do not transfer to my computer

Cause: The HP Photosmart Software is not installed.

Solution: Install the HP Photosmart Software that came with the HP All-in-One. If it is installed, restart your computer.

To install the HP Photosmart Software

1. Insert the HP All-in-One CD-ROM into your computer's CD-ROM drive and then start the Setup program.
2. When prompted, click **Install More Software** to install the HP Photosmart Software.
3. Follow the onscreen instructions and the instructions provided in the Setup Guide that came with the HP All-in-One.

Cause: The HP All-in-One is turned off.

Solution: Turn the HP All-in-One on.

Cause: The computer is turned off.

Solution: Turn the computer on.

Cause: The HP All-in-One is not properly connected to the computer.

Solution: If the HP All-in-One is directly connected to a computer with a USB cable, check the physical connection from the HP All-in-One to the computer. Verify that the USB cable is securely plugged into the USB port on the back of the HP All-in-One. Make sure the other end of the USB cable is plugged into a USB port on your computer. After the cable is connected properly, turn the HP All-in-One off and then on again.

If the HP All-in-One is network-connected, check physical network connections and make sure the network is operational. Once you verify network connectivity, retry the task.

For more information, see:

- [“Communication problems over a USB connection” on page 109](#)
- [“Network troubleshooting” on page 120](#)

Memory card is not available

Cause: If this message appears on your display, it means that another user is accessing the memory card over the network. Other users who try to use the same memory card might see a read/write error message. The memory card might not appear, as expected, in a list of shared network drives. In addition, if the HP All-in-One is connected to your computer by a USB cable, the computer might be accessing the memory card, making it inaccessible to the HP All-in-One.

Solution: Wait until the other user has finished using the memory card.

The file name appears as meaningless text

Cause: The HP All-in-One does not support Unicode. This is a limitation of the Common Internet File System (CIFS) server.

The CIFS server is included in all network-connected HP All-in-One devices. It provides network drive letter access to the memory card in the HP All-in-One. This lets you read/write files on the network from the memory card in the HP All-in-One. The CIFS server appears on your computer as a network drive. In addition to reading/writing files from your memory card, you can also create folders and store other information.

Solution: If a file name was created with Unicode by another application, it will display as arbitrary characters.

Other users on the network can access my memory card

Cause: The Common Internet File System (CIFS) server in the HP All-in-One does not support authentication. This is a limitation of the CIFS server.

The CIFS server is included in all network-connected HP All-in-One devices. It provides network drive letter access to the memory card in the HP All-in-One. This lets you read/write files on the network from the memory card in the HP All-in-One. The CIFS server appears on your computer as a network drive. In addition to reading/writing files from your memory card, you can also create folders and store other information.

Solution: Every user on the network can access the memory card.

Error message: Cannot find the file or item. Make sure the path and file name are correct.

Cause: The Common Internet File System (CIFS) server in the HP All-in-One is not operational.

The CIFS server is included in all network-connected HP All-in-One devices. It provides network drive letter access to the memory card in the HP All-in-One. This lets you read/write files on the network from the memory card in the HP All-in-One. The CIFS server appears on your computer as a network drive. In addition to reading/writing files from your memory card, you can also create folders and store other information.

Solution: Retry your task at a later time.

Scan troubleshooting

Use this section to solve these scan problems:

- [Scan halts](#)
- [Scan fails](#)
- [Scan fails because of insufficient computer memory](#)
- [Scanned image is blank](#)
- [Scanned image is incorrectly cropped](#)
- [Scanned image has incorrect page layout](#)
- [Scanned image shows dotted lines instead of text](#)

- [Text format is incorrect](#)
- [Text is incorrect or missing](#)
- [The scan feature does not work](#)

Scan halts

Cause: The computer system resources might be low.

Solution: Turn off the HP All-in-One and then turn it back on. Turn off the computer and then turn it back on.

If this does not work, try changing the scan to a lower resolution.

Scan fails

Cause: The computer is not turned on.

Solution: Turn on your computer.

Cause: Your computer is not connected to the HP All-in-One by a USB cable or network cable.

Solution: Connect your computer to the HP All-in-One with a standard USB cable or across a network.

Cause: The HP All-in-One software might not have been installed.

Solution: Insert the HP All-in-One installation CD and install the software.

Cause: The software you installed with the HP All-in-One is not running.

Solution: Open the software you installed with the HP All-in-One and try scanning again.

Scan fails because of insufficient computer memory

Cause: Too many programs are running on your computer.

Solution: Close all programs that are not in use. This includes programs that run in the background, such as screen savers and virus checkers. If you turn off your virus checker, remember to turn it back on after you finish your scan.

If this does not work, it might help to restart your computer. Some programs do not release memory when you close them. Restarting your computer will clear the memory.

If this problem occurs frequently, or if you encounter memory problems while using other programs, you might need to add more memory to your computer. See the user guide that came with your computer for more information.

Scanned image is blank

Cause: The original is placed incorrectly on the glass.

Solution: Load your original print side down on the right front corner of the glass.

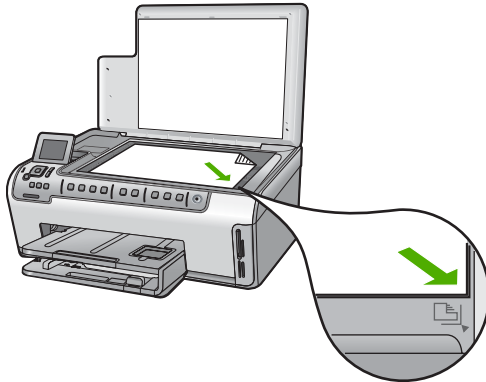

Scanned image is incorrectly cropped

Cause: The software is set to automatically crop scanned pictures.

Solution: The **Autocrop** feature crops anything that is not part of the main image. Sometimes this might not be what you want. In that case, you can turn off autocropping and crop the scanned image manually, or not at all.

Scanned image has incorrect page layout

Cause: Automatic cropping is changing the page layout.

Solution: Turn off automatic cropping to retain the page layout.

Scanned image shows dotted lines instead of text

Cause: If you use the **Text** image type to scan text that you plan to edit, the scanner might not recognize color text. The **Text** image type scans at 300 x 300 dpi, in black and white.

If you are scanning an original that has graphics or artwork surrounding the text, the scanner might not recognize the text.

Solution: Make a black-and-white copy of the original and then scan the copy.

Text format is incorrect

Cause: The scan document settings are incorrect.

Solution: Some applications cannot handle framed text formatting. Framed text is one of the scan document settings. It maintains complex layouts, such as multiple columns from a newsletter, by putting the text in different frames (boxes) in the destination application.

Text is incorrect or missing

Cause: The brightness is not set correctly.

Solution: Adjust the brightness, and then rescan the original.

Cause: Debris might be stuck on the glass or on the back of the document lid. This can cause poor-quality scans.

Solution: Clean the glass and lid backing.

For more information, see:

- [“Clean the lid backing” on page 98](#)
 - [“Clean the glass” on page 97](#)
-

Cause: The scan document settings are not set to the correct optical character recognition (OCR) language. The **OCR language** tells the software how to interpret the characters it sees in the original image. If the **OCR language** does not match the language in the original, the scanned text might be incomprehensible.

Solution: Select the correct OCR language.

 **NOTE:** If you are using HP Photosmart Essential, the Optical Character Recognition (OCR) software might not be installed on your computer. To install the OCR software, you must re-insert the software disk and select **OCR** under the **Custom** installation options.

The scan feature does not work

Cause: The computer is turned off.

Solution: Turn the computer on.

Cause: The HP All-in-One is not properly connected to the computer through a USB cable or a network cable.

Solution: Check the cables that connect the HP All-in-One to your computer or network.

Cause: The software that came with the HP All-in-One is not installed or is not running.

Solution: Restart your computer. If that does not help, install or reinstall the software that came with the HP All-in-One.

Copy troubleshooting

Use this section to solve these copy problems:

- [Copies are too light or too dark](#)
- [Nothing happens when I try to copy](#)

- [Parts of the original do not appear or are cut off](#)
- [Fit to Page is not working as expected](#)
- [A borderless copy has white space around the edges](#)
- [The image is cropped when I make a borderless copy](#)
- [The printout is blank](#)

Copies are too light or too dark

Cause: The **Lighter/Darker** setting for the HP All-in-One is set too light or too dark.

Solution: Adjust the lightness and darkness of the copies.

For more information, see:

[“Adjust the lightness and darkness of your copy” on page 89](#)

Cause: The original you are copying is overexposed.

Solution: Try using **Enhancements** to improve an overexposed image.

For more information, see:

[“Improve the quality of a copy” on page 92](#)

Nothing happens when I try to copy

Cause: The HP All-in-One is turned off.

Solution: Look at the display on the HP All-in-One. If the display is blank and the **On** button is not lit, the HP All-in-One is turned off. Make sure the power cord is firmly connected to the HP All-in-One and plugged into a power outlet. Press the **On** button to turn on the HP All-in-One.

Cause: The original is placed incorrectly on the glass.

Solution: Load your original print side down on the right front corner of the glass.

For more information, see:

[“Load originals” on page 33](#)

Cause: The HP All-in-One might be busy copying or printing.

Solution: Check the display to see if the HP All-in-One is busy.

Cause: The HP All-in-One does not recognize the paper type.

Solution: Do not use the HP All-in-One to copy onto envelopes or other papers the HP All-in-One does not support.

Cause: The HP All-in-One has a paper jam.

Solution: Clear the paper jam and remove any torn paper that remains in the HP All-in-One.

For more information, see:

[“Clear paper jams” on page 111](#)

Parts of the original do not appear or are cut off

Cause: The original is placed incorrectly on the glass.

Solution: Load your original print side down on the right front corner of the glass.

For more information, see:

[“Load originals” on page 33](#)

Cause: The original fills the entire sheet.

Solution: If the image or text on your original fills the entire sheet with no margins, use the **Fit to Page** feature to reduce your original and prevent unwanted cropping of the text or images at the edges of the sheet.

For more information, see:

[“Resize an original to fit onto letter or A4 paper” on page 91](#)

Cause: The original is larger than the paper in the input tray.

Solution: If your original is larger than the paper in the input tray, use the **Fit to Page** feature to reduce your original to fit on the paper in the input tray.

For more information, see:

[“Resize an original to fit onto letter or A4 paper” on page 91](#)

Fit to Page is not working as expected

Cause: You are trying to increase the size of an original that is too small.

Solution: **Fit to Page** can only enlarge the original up to the maximum percentage allowed by your model. (The maximum percentage varies by model.) For example, 200% might be the maximum enlargement percentage allowed by your model. Enlarging a passport photo by 200% might not enlarge it enough for it to fit a full-size page.

If you want to make a large copy of a small original, scan the original into the computer, resize the image in the HP scanning software, and then print a copy of the enlarged image.

Cause: The original is placed incorrectly on the glass.

Solution: Load your original print side down on the right front corner of the glass.

For more information, see:

[“Load originals” on page 33.](#)

Cause: Debris might be stuck on the glass or on the back of the document lid. The HP All-in-One interprets anything it detects on the glass as part of the image.

Solution: Turn off the HP All-in-One, and then use a soft cloth to wipe the glass and the back of the document lid.

For more information, see:

- [“Clean the glass” on page 97](#)
 - [“Clean the lid backing” on page 98](#)
-

A borderless copy has white space around the edges

Cause: You are trying to make a borderless copy of an original that is too small.

Solution: When you make a borderless copy of a small original, the HP All-in-One enlarges the original up to a maximum percentage. This might leave white space around the edges. (The maximum percentage varies by model.)

Depending on the size of the borderless copy you are trying to make, the minimum size of the original varies. For example, you cannot enlarge a passport photo to create a letter-size borderless copy.

If you want to make a borderless copy of a very small original, scan the original into the computer, resize the image in the HP scanning software, and then print a borderless copy of the enlarged image.

Cause: You are trying to make a borderless copy without using photo paper.

Solution: Use photo paper to make borderless copies.

For more information, see:

[“Make a borderless copy of a photo” on page 90](#)

Cause: Debris might be stuck on the glass or on the back of the document lid. The HP All-in-One interprets anything it detects on the glass as part of the image.

Solution: Turn off the HP All-in-One, and then use a soft cloth to wipe the glass and the back of the document lid.

For more information, see:

- [“Clean the glass” on page 97](#)
 - [“Clean the lid backing” on page 98](#)
-

The image is cropped when I make a borderless copy

Cause: The HP All-in-One cropped some of the image around the margins of the copy to achieve a borderless print without changing the proportions of the original.

Solution: If you want to enlarge a photo to fit a full-size page without cropping the edges, use **Fit to Page**.

For more information, see:

- [“Resize an original to fit onto letter or A4 paper” on page 91](#)
 - [“Resize an original using custom settings” on page 91](#)
-

Cause: The original is larger than the paper in the input tray.

Solution: If your original is larger than the paper in the input tray, use the **Fit to Page** feature to reduce your original to fit on the paper in the input tray.

For more information, see:

[“Resize an original to fit onto letter or A4 paper” on page 91](#)

The printout is blank

Cause: The original is placed incorrectly on the glass.

Solution: Load your original print side down on the right front corner of the glass.

For more information, see:

[“Load originals” on page 33](#)

Errors

This section contains the following categories of messages on your device:

- [Device messages](#)
- [File messages](#)
- [General user messages](#)
- [Paper messages](#)
- [Power and connection messages](#)
- [Ink cartridge messages](#)

Device messages

The following is a list of device-related error messages:

- [Firmware revision mismatch](#)
- [Mechanism error](#)
- [Memory is full](#)
- [Scanner failure](#)
- [Photo tray problem](#)
- [Photo tray cannot engage](#)

- [Photo tray cannot disengage](#)
- [Two-sided printing accessory is missing](#)

Firmware revision mismatch

Cause: The revision number of the HP All-in-One firmware does not match the revision number of the software.

Solution: To find support and warranty information, go to the HP Web site at www.hp.com/support. If prompted, choose your country/region, and then click

Contact HP for information on calling for technical support.

Mechanism error

Cause: The HP All-in-One has a paper jam.

Solution: Clear the paper jam.

For more information, see:

[“Clear paper jams” on page 111](#)

Cause: The print head assembly is blocked or stalled.

Solution: Turn the HP All-in-One off and open the ink cartridge door. Remove any objects that are blocking the print head assembly (including any packing materials), and then turn the HP All-in-One on again.

Memory is full

Cause: The document you are copying has exceeded the memory of the HP All-in-One.

Solution: Try making fewer copies.

Scanner failure

Cause: The HP All-in-One is busy or an unknown cause has interrupted your scan.

Solution: Turn off the HP All-in-One and then turn it on again. Restart your computer and then try to scan again.

If the problem persists, try plugging the power cord directly into a grounded power outlet rather than a surge protector or power strip. If the problem continues, contact HP support. Go to www.hp.com/support. If prompted, choose your country/region, and then click **Contact HP** for information on calling for technical support.

Photo tray problem

Cause: There is not enough paper in the photo tray.

Solution: If the photo tray is empty or there are only a few sheets remaining, load more paper in the photo tray. If there is paper in the photo tray, remove the paper,

tap the stack of paper against a flat surface, and reload the paper into the photo tray. Follow the prompts on the display or the computer screen to continue your print job.

Cause: The paper is not feeding properly or is loaded incorrectly.

Solution: Make sure you have paper loaded correctly in the photo tray.

Cause: There might be too much paper loaded in the photo tray.

Solution: Do not overload the photo tray; make sure the stack of photo paper fits within the photo tray and is no higher than the top of the paper-width guide.

Cause: Two or more pieces of paper might be stuck together.

Solution: Remove the paper from the photo tray and shuffle the paper so it does not stick together. Reload the paper into the photo tray and try printing again.

Cause: The photo paper might be curled.

Solution: If the photo paper is curled, place the paper in a plastic bag and gently bend it the opposite direction of the curl until the paper lies flat. If the problem persists, use photo paper that is not curled.

Cause: You might be using the printer in an extremely high- or low-humidity environment.

Solution: Load one sheet of photo paper at a time.

Cause: The photo tray cannot engage or disengage.

Solution: Re-insert the photo tray and lower the output tray. To continue your print job, press **OK** on the control panel of the HP All-in-One.

Photo tray cannot engage

Cause: The photo tray might not be pushed all the way in.

Solution: Lift the output tray, then push the photo tray all the way in. Push the output tray all the way down.

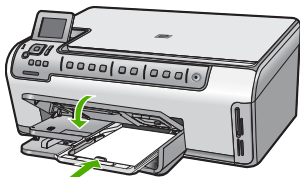

Photo tray cannot disengage

Cause: The output tray might not be lowered all the way.

Solution: Push the output tray all the way down.

Two-sided printing accessory is missing

Cause: The Two-sided printing accessory is not installed or it is installed incorrectly.

Solution: Firmly insert the Two-sided printing accessory into the back of the device until both sides snap into place.

 **NOTE:** Do not press the buttons on either side of the accessory when installing it. Use the buttons only when removing the accessory from the device.

File messages

The following is a list of file-related error messages:

- [Error reading or writing the file](#)
- [Unreadable files. NN files could not be read](#)
- [Photos not found](#)
- [File not found](#)
- [File format not supported](#)
- [Invalid file name](#)
- [Supported file types for the HP All-in-One](#)
- [File corrupted](#)

Error reading or writing the file

Cause: The HP All-in-One software could not open or save the file.

Solution: Check to see if you typed the correct folder and file name.

Unreadable files. NN files could not be read

Cause: Some of the files on the inserted memory card are damaged.

Solution: Reinsert the memory card in the HP All-in-One or try transferring the files to your computer using a memory card reader or a USB cable. If you already transferred the files to your computer, try printing those files by using the HP Photosmart Software. The copies might not be damaged. If these solutions do not work, retake the photos with your digital camera as a last resort.

Photos not found

Cause: Some of the files on the inserted memory card are damaged.

Solution: Reinsert the memory card in the HP All-in-One or try transferring the files to your computer using a memory card reader or a USB cable. If you already transferred the files to your computer, try printing those files by using the

HP Photosmart Software. The copies might not be damaged. If these solutions do not work, retake the photos with your digital camera as a last resort.

Cause: There are no photos found on the memory card.

Solution: Take some photos with your digital camera, or if you previously saved photos on your computer, you can print them using the HP Photosmart Software.

File not found

Cause: There is not enough available memory on your computer to create a print preview file.

Solution: Close some applications and try the task again.

File format not supported

Cause: The HP All-in-One software did not recognize or support the file format of the image you are trying to open or save. If the file extension indicates it is a supported file type, the file might be corrupted.

Solution: Open the file in another application, and save it in a format that the HP All-in-One software recognizes.

For more information, see:

[“Supported file types for the HP All-in-One” on page 153](#)

Invalid file name

Cause: The file name you entered is invalid.

Solution: Make sure that you are not using any invalid symbols in the file name.

 **NOTE:** Although the file name might look correct, it could still include invalid characters. Overwrite the existing file name with a new name.

Supported file types for the HP All-in-One

The HP All-in-One software recognizes the following file formats: BMP, DCX, FPX, GIF, JPG, PCD, PCX, TIF, PICT, PSD, PCS, EPS, TGA, SGI, PDF, and PNG.

File corrupted

Cause: Some of the files on the inserted memory card are damaged.

Solution: Reinsert the memory card in the HP All-in-One or try transferring the files to your computer using a memory card reader or a USB cable. If you already transferred the files to your computer, try printing those files by using the HP Photosmart Software. The copies might not be damaged. If these solutions do not work, retake the photos with your digital camera as a last resort.

Cause: The file system is corrupted.

Solution: Check the display for an error message telling you that the images on the memory card are corrupted.

If the file system on the card is corrupt, reformat the memory card in your digital camera.

△ **CAUTION:** Reformatting the memory card will delete any photos stored on the card. If you have previously transferred the photos from your memory card to a computer, try printing the photos from the computer. Otherwise, you will need to retake any photos you might have lost.

General user messages

The following is a list of messages related to common user errors:

- [Cannot crop](#)
- [Memory card error](#)
- [Disconnected](#)
- [No scan options](#)
- [Out of disk space](#)
- [Memory card must be in slot](#)
- [Card access error](#)
- [Use only one card at a time](#)
- [Card is inserted incorrectly](#)
- [Card is not fully inserted](#)
- [Card is damaged](#)

Cannot crop

Cause: The computer does not have enough memory.

Solution: Close all unnecessary applications. This includes applications that run in the background, such as screensavers and virus checkers. (If you turn off your virus checker, remember to turn it back on after you finish.) Try restarting your computer to clear the memory. You might need to purchase more RAM. Refer to the documentation that came with your computer.

Cause: For scanning, there must be at least 50 MB of space available on your computer's hard disk.

Solution: Empty the Recycle Bin on your desktop. You might also need to remove files from the hard disk.

Memory card error

Cause: There are two or more memory cards inserted into the HP All-in-One at the same time.

Solution: Remove all but one memory card. The HP All-in-One reads the remaining memory card and displays the first photo stored on the memory card.

Cause: You have inserted a Compact Flash memory card backwards or upside down.

Solution: Remove the memory card and reinsert it correctly. The front label of the Compact Flash card faces left.

Cause: You have not fully inserted the memory card.

Solution: Remove the memory card and reinsert it in the memory card slot until it stops.

Disconnected

Cause: Several situations can cause this error message to appear.

- Your computer is not turned on.
- Your computer is not connected to the HP All-in-One.
- The software that came with the HP All-in-One was not installed correctly.
- The software that came with the HP All-in-One is installed, but it is not running.

Solution: Make sure your computer is turned on and is connected to the HP All-in-One. Also make sure you installed the software that came with the HP All-in-One.

For more information, see:

- [“Communication problems over a USB connection” on page 109](#)
 - [“Network troubleshooting” on page 120](#)
-

No scan options

Cause: The software that came with the HP All-in-One is not running, or has never been installed.

Solution: Make sure the software is installed and running. For more information, see the Setup Guide that came with the HP All-in-One.

Out of disk space

Cause: There is not enough available memory on your computer to perform the task.

Solution: Close some applications and try the task again.

Memory card must be in slot

Cause: The feature you are trying to use is only available when there is a memory card inserted in the HP All-in-One.

Solution: Make sure you fully insert the memory card into the appropriate slot on the HP All-in-One, and then try the task again.

Card access error

Cause: There are two or more memory cards inserted into the HP All-in-One at the same time.

Solution: Remove all but one memory card. The HP All-in-One reads the remaining memory card and displays the first photo stored on the memory card.

Cause: You have inserted a Compact Flash memory card backwards or upside down.

Solution: Remove the memory card and reinsert it correctly. The front label of the Compact Flash card faces left.

Cause: You have not fully inserted the memory card.

Solution: Remove the memory card and reinsert it in the memory card slot until it stops.

Use only one card at a time

Cause: Multiple memory cards are inserted in the HP All-in-One.

Solution: You can insert only one memory card at a time.

If more than one memory card is inserted, the Attention light will blink rapidly, and an error message will appear on the display. Remove the additional memory card to resolve the problem.

Card is inserted incorrectly

Cause: The card is inserted backwards or upside down.

Solution: Turn the memory card so that the front label faces left and the contacts are on the right, and then push the card forward into the appropriate slot until the Photo light turns on.

If the memory card is not inserted properly, the HP All-in-One will not respond and the Photo light (near the memory card slots) will not turn on.

After the memory card has been inserted properly, the Photo light will blink for a few seconds, and then remain lit.

Card is not fully inserted

Cause: The card is not fully inserted.

Solution: Make sure you fully insert the memory card into the appropriate slot on the HP All-in-One.

If the memory card is not inserted properly, the HP All-in-One will not respond and the Photo light (near the memory card slots) will not turn on.

After the memory card has been inserted properly, the Photo light will blink for a few seconds, and then remain lit.

Card is damaged

Cause: You formatted the card on a Windows XP computer. By default, Windows XP will format a memory card of 8 MB or less and 64 MB or more with the FAT32 format. Digital cameras and other devices use the FAT (FAT16 or FAT12) format and cannot recognize a FAT32 formatted card.

Solution: Reformat your memory card in your camera or format your memory card in a Windows XP computer by selecting the FAT format.

Cause: The file system is corrupted.

Solution: Check the display for an error message telling you that the images on the memory card are corrupted.

If the file system on the card is corrupt, reformat the memory card in your digital camera.

△ **CAUTION:** Reformatting the memory card will delete any photos stored on the card. If you have previously transferred the photos from your memory card to a computer, try printing the photos from the computer. Otherwise, you will need to retake any photos you might have lost.

Paper messages

The following is a list of paper-related error messages:

- [Cannot load paper from input tray](#)
- [Ink is drying](#)
- [Out of paper](#)
- [Paper jam, misfeed or blocked print head assembly](#)
- [Paper mismatch](#)
- [Paper mismatch for photo](#)
- [Wrong paper width](#)

Cannot load paper from input tray

Cause: There is not enough paper in the input tray.

Solution: If the HP All-in-One is out of paper or there are only a few sheets remaining, load more paper in the input tray. If there is paper in the input tray, remove the paper, tap the stack of paper against a flat surface, and reload the paper into the input tray. Follow the prompts on the display or the computer screen to continue your print job.

For more information, see:

[“Load full-size paper” on page 37](#)

Ink is drying

Cause: Transparencies and some other media require a drying time that is longer than normal.

Solution: Leave the sheet in the output tray until the message disappears. If it is necessary to remove the printed sheet before the message disappears, carefully hold the printed sheet on the underside or the edges, and place it on a flat surface to dry.

Out of paper

Cause: There is not enough paper in the input tray.

Solution: If the HP All-in-One is out of paper or there are only a few sheets remaining, load more paper in the input tray. If there is paper in the input tray, remove the paper, tap the stack of paper against a flat surface, and reload the paper into the input tray. Follow the prompts on the display or the computer screen to continue your print job.

For more information, see:

[“Load full-size paper” on page 37](#)

Cause: The Two-sided printing accessory is off the HP All-in-One.

Solution: If you removed the Two-sided printing accessory to clear a paper jam, replace it.

For more information, see:

[“Clear paper jams” on page 111](#)

Paper jam, misfeed or blocked print head assembly

Cause: Paper has jammed the HP All-in-One.

Solution: Clear the jam. To continue your print job, press **OK** on the control panel of the HP All-in-One.

For more information, see:

[“Clear paper jams” on page 111](#)

Cause: The print head assembly is blocked.

Solution: Turn off the HP All-in-One and open the ink cartridge door to access the print head assembly area. Remove any objects that are blocking the print head, including any packing materials. Turn the HP All-in-One on again.

Paper mismatch

Cause: The print setting for the print job does not match the paper type or size loaded in the HP All-in-One.

Solution: Change the print setting or load the appropriate paper in the input tray.

For more information, see:

[“Change the print settings for the current job” on page 46](#)

[“Information on paper” on page 111](#)

Paper mismatch for photo

Cause: The image size for the photo is larger than the paper loaded.

Solution: Replace the paper in the input tray with a larger sized paper. To continue your print job, press **OK** on the control panel of the HP All-in-One.

Wrong paper width

Cause: The print setting chosen for the print job does not match the paper loaded in the HP All-in-One.

Solution: Change the print setting or load the appropriate paper in the input tray.

For more information, see:

[“Information on paper” on page 111](#)

[“Change the print settings for the current job” on page 46](#)

[“Load paper” on page 36](#)

Power and connection messages

The following is a list of power- and connection-related error messages:

- [Communication test failed](#)
- [HP All-in-One not found](#)
- [Improper shutdown](#)
- [Two-way communication lost](#)

Communication test failed

Cause: The HP All-in-One is turned off.

Solution: Look at the display on the HP All-in-One. If the display is blank and the **On** button is not lit, the HP All-in-One is turned off. Make sure the power cord is firmly connected to the HP All-in-One and plugged into a power outlet. Press the **On** button to turn on the HP All-in-One.

Cause: The HP All-in-One is not connected to the computer.

Solution: If the HP All-in-One is not properly connected to the computer, communication errors can occur. Make sure the USB cable is securely connected to the HP All-in-One and the computer, as shown below.

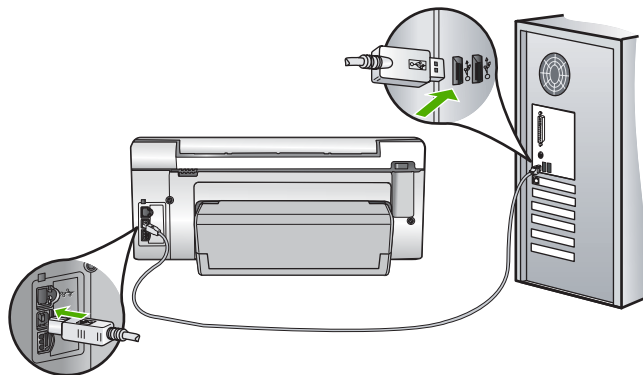

For more information, see:

[“Communication problems over a USB connection” on page 109](#)

HP All-in-One not found

Cause: This error applies only to USB-connected devices. The USB cable is not plugged in properly.

Solution: If the HP All-in-One is not properly connected to the computer, communication errors can occur. Make sure the USB cable is securely connected to the HP All-in-One and the computer, as shown below.

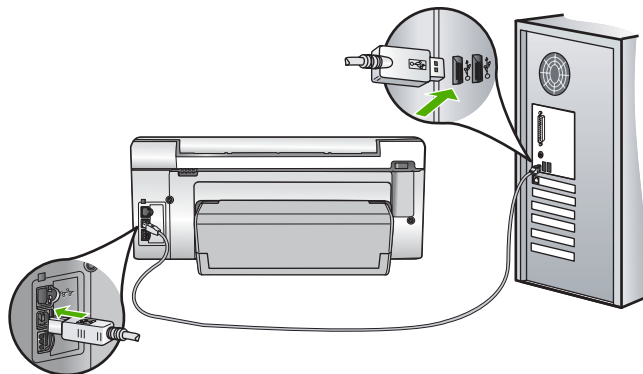

For more information, see:

[“Communication problems over a USB connection” on page 109](#)

Improper shutdown

Cause: The last time the HP All-in-One was used, it was not turned off properly. If the HP All-in-One is turned off by turning off the switch on a power strip or by using a wall switch, the device can be damaged.

Solution: Press the **On** button located on the control panel of the HP All-in-One to turn the device on and off.

Two-way communication lost

Cause: The HP All-in-One is turned off.

Solution: Look at the display on the HP All-in-One. If the display is blank and the **On** button is not lit, the HP All-in-One is turned off. Make sure the power cord is firmly connected to the HP All-in-One and plugged into a power outlet. Press the **On** button to turn on the HP All-in-One.

Cause: The HP All-in-One is not connected to the computer.

Solution: If the HP All-in-One is not properly connected to the computer, communication errors can occur. Make sure the USB cable is securely connected to the HP All-in-One and the computer, as shown below.

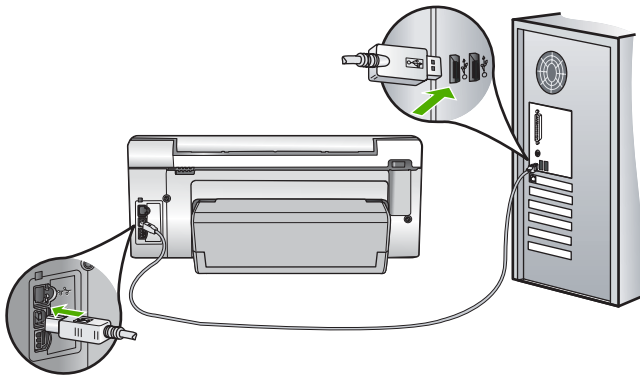

For more information, see:

[“Communication problems over a USB connection”](#) on page 109

Ink cartridge messages

The following is a list of ink cartridge error messages:

- [Calibration error](#)
- [Cannot print](#)
- [Incompatible ink cartridge\(s\)](#)
- [The following ink cartridges cannot be used after device initialization and must be replaced](#)

- [Ink cartridge problem](#)
- [Ink cartridge\(s\) are empty](#)
- [Ink cartridge\(s\) are expired](#)
- [Ink delivery failure](#)
- [Ink expiration near](#)
- [Ink supply error](#)
- [Non-HP ink](#)
- [Original HP ink depleted](#)
- [Print head assembly is stalled](#)
- [Print head failure](#)
- [Alignment failed](#)
- [Replace ink cartridges soon](#)
- [Scheduled maintenance](#)
- [Wrong ink cartridge\(s\) installed](#)
- [Ink cartridge is missing, incorrectly installed, or not intended for your device](#)

Calibration error

Cause: An incorrect type of paper is loaded in the input tray.

Solution: If you have color or photo paper loaded in the input tray when the printer aligns, the calibration might fail. Load unused plain white letter or A4 paper into the input tray, and then press **OK** on the control panel.

Cannot print

Cause: The indicated ink cartridge(s) are out of ink.

Solution: Replace the indicated ink cartridge(s) immediately so that you can resume printing.

The HP All-in-One cannot continue printing until the indicated ink cartridge(s) are replaced. All printing will stop.

For more information, see:

[“Replace the ink cartridges” on page 99](#)

Incompatible ink cartridge(s)

Cause: The wrong ink cartridge(s) are installed.

Solution: The indicated ink cartridge(s) cannot be used after the device has undergone first-time setup. Replace the ink cartridge(s) with the appropriate ink cartridges for the HP All-in-One. To find out the reorder number for all the ink cartridges that the HP All-in-One supports, see the printed documentation that came with the HP All-in-One.

For more information, see:

[“Replace the ink cartridges” on page 99](#)

Cause: The ink cartridge(s) are not intended for use in this device.

Solution: Contact HP support. Go to:

www.hp.com/support

If prompted, choose your country/region, and then click **Contact HP** for information on calling for technical support.

The following ink cartridges cannot be used after device initialization and must be replaced

Cause: The wrong ink cartridge(s) are installed.

Solution: The indicated ink cartridge(s) cannot be used after the device has undergone first-time setup. Replace the ink cartridge(s) with the appropriate ink cartridges for the HP All-in-One. To find out the reorder number for all the ink cartridges that the HP All-in-One supports, see the printed documentation that came with the HP All-in-One.

For more information, see:

[“Replace the ink cartridges” on page 99](#)

Cause: The ink cartridge(s) are not intended for use in this device.

Solution: Contact HP support. Go to:

www.hp.com/support

If prompted, choose your country/region, and then click **Contact HP** for information on calling for technical support.

Ink cartridge problem

Cause: The indicated ink cartridge(s) are missing or are damaged.

Solution: Replace the indicated ink cartridge(s) immediately so that you can resume printing. If there are no ink cartridges missing from the HP All-in-One, the ink cartridge contacts might need to be cleaned.

If there are no ink cartridges missing from the HP All-in-One, and you still receive this message after cleaning the ink cartridge contacts, you might have a damaged ink cartridge. Check to see if your ink cartridge is still under warranty and the end of warranty date has not been reached.

- If the end of warranty date has been reached, purchase a new ink cartridge.
- If the end of warranty date has not been reached, contact HP support. Go to www.hp.com/support. If prompted, choose your country/region, and then click **Contact HP** for information on calling for technical support.

For more information, see:

- [“Replace the ink cartridges” on page 99](#)
- [“Clean the ink cartridge contacts” on page 104](#)

- [“Ink cartridge warranty information”](#) on page 169
 - [“Shop for ink supplies”](#) on page 107
-

Ink cartridge(s) are empty

Cause: The indicated ink cartridge(s) are out of ink.

Solution: Replace the indicated ink cartridge(s) with new ink cartridge(s).

For more information, see:

[“Replace the ink cartridges”](#) on page 99

Ink cartridge(s) are expired

Cause: The ink in the indicated ink cartridge(s) is at the expiration date.

Solution: Each ink cartridge has an expiration date. The purpose of expiration is to protect the printing system and to ensure ink quality. When you receive an ink cartridge(s) are expired message, remove and replace the expired ink cartridge, and then close the message. You can also continue printing without replacing the ink cartridge, by following the instructions on the HP All-in-One or the ink cartridge expiration message on your computer screen. HP recommends replacing the expired ink cartridges. HP cannot guarantee the quality or reliability of expired ink cartridges. Device service or repairs required as a result of using expired ink will not be covered under warranty.

For more information, see:

[“Replace the ink cartridges”](#) on page 99

Ink delivery failure

Cause: The print head assembly or the ink delivery system has failed and the HP All-in-One can no longer print.

Solution: Turn the HP All-in-One off, unplug the power cord, and wait 10 seconds. Then, plug the power cord back in and turn the device on.

If you continue to receive this message, write down the error code provided in the message, and then contact HP support. Go to:

www.hp.com/support

If prompted, choose your country/region, and then click **Contact HP** for information on calling for technical support.

Ink expiration near

Cause: The ink in the indicated ink cartridge(s) is near expiration.

Solution: One or more of the ink cartridges are near their expiration date.

Each ink cartridge has an expiration date. The purpose of expiration is to protect the printing system and to ensure ink quality. When you receive an ink cartridge(s) are expired message, remove and replace the expired ink cartridge, and then close the message. You can also continue printing without replacing the ink cartridge, by following the instructions on the HP All-in-One or the ink cartridge expiration message on your computer screen. HP recommends replacing the expired ink cartridges. HP cannot guarantee the quality or reliability of expired ink cartridges. Device service or repairs required as a result of using expired ink will not be covered under warranty.

For more information, see:

[“Replace the ink cartridges” on page 99](#)

Ink supply error

Cause: The indicated ink cartridge was removed during maintenance.

Solution: Replace the indicated ink cartridge with the previous ink cartridge during the maintenance procedure. After the maintenance procedure is complete, you can insert the new ink cartridge.

For more information, see:

[“Replace the ink cartridges” on page 99](#)

Non-HP ink

Cause: The HP All-in-One detected non-HP ink.

Solution: Replace the indicated ink cartridge(s).

HP recommends that you use genuine HP ink cartridges. Genuine HP ink cartridges are designed and tested with HP printers to help you easily produce great results, time after time.

 **NOTE:** HP cannot guarantee the quality or reliability of non-HP ink. Printer service or repairs required as a result of printer failure or damage attributable to the use of non-HP ink will not be covered under warranty.

If you believe you purchased genuine HP ink cartridge(s), go to:

www.hp.com/go/anticounterfeit

For more information, see:

[“Replace the ink cartridges” on page 99](#)

Original HP ink depleted

Cause: The original HP ink in the indicated ink cartridge(s) has been depleted.

Solution: Replace the indicated ink cartridge(s) or press **OK** on the control panel to continue.

HP recommends that you use genuine HP ink cartridges. Genuine HP ink cartridges are designed and tested with HP printers to help you easily produce great results, time after time.

 **NOTE:** HP cannot guarantee the quality or reliability of non-HP ink. Printer service or repairs required as a result of printer failure or damage attributable to the use of non-HP ink will not be covered under warranty.

For more information, see:

[“Replace the ink cartridges” on page 99](#)

Print head assembly is stalled

Cause: The print head assembly is blocked.

Solution: Remove any objects that are blocking the print head assembly.

To clear the print head assembly

1. Open the ink cartridge door by lifting from the front center of the device, until the door locks into place.

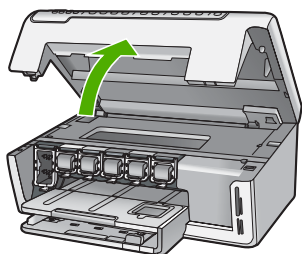

2. Remove any objects that are blocking the print head assembly, including any packing materials.
 3. Turn the HP All-in-One off, then turn it on again.
 4. Close the ink cartridge door.
-

Print head failure

Cause: The print head assembly or the ink delivery system has failed and the HP All-in-One can no longer print.

Solution: Contact HP support. Go to:

www.hp.com/support

If prompted, choose your country/region, and then click **Contact HP** for information on calling for technical support.

Alignment failed

Cause: An incorrect type of paper is loaded in the input tray.

Solution: If you have color or photo paper loaded in the input tray when you align the printer, the alignment might fail. Load unused plain white letter or A4 paper into the input tray, and then try the alignment again. If the alignment fails again, you might have a defective sensor.

Contact HP support. Go to:

www.hp.com/support

If prompted, choose your country/region, and then click **Contact HP** for information on calling for technical support.

Cause: The print head assembly or sensor is defective.

Solution: Contact HP support. Go to:

www.hp.com/support

If prompted, choose your country/region, and then click **Contact HP** for information on calling for technical support.

Replace ink cartridges soon

Cause: The indicated ink cartridge is estimated to be low on ink and might need to be replaced soon.

Solution: You might be able to continue printing for a short period of time with ink remaining in the print head assembly. Replace the indicated ink cartridge(s) or follow the prompts on the display or computer screen to continue.

For more information, see:

[“Replace the ink cartridges” on page 99](#)

Scheduled maintenance

Cause: The HP All-in-One performs a periodic maintenance procedure to ensure excellent print quality.

Solution: Load unused plain white letter or A4 paper in the input tray. Then follow the prompts on the display or computer screen to continue.

Wrong ink cartridge(s) installed

Cause: The wrong ink cartridge(s) are installed.

Solution: The first time you set up and use the HP All-in-One, make sure to install the ink cartridges that were shipped with your device. The ink in these ink cartridges is specially formulated to mix with the ink in the print head assembly.

To resolve this error, replace the affected ink cartridge(s) with the ink cartridges that were shipped with the HP All-in-One.

For more information, see:

[“Replace the ink cartridges” on page 99](#)

Ink cartridge is missing, incorrectly installed, or not intended for your device

Cause: One or more ink cartridges are missing.

Solution: Remove and reinsert the ink cartridges and verify that they are fully inserted and locked in place.

Cause: One or more of the ink cartridges are not installed or are installed incorrectly.

Solution: Remove and reinsert the ink cartridges and verify that they are fully inserted and locked in place. If the problem persists, clean the copper-colored contacts of the ink cartridges.

For more information, see:

- [“Replace the ink cartridges” on page 99](#)
 - [“Clean the ink cartridge contacts” on page 104](#)
-

Cause: The ink cartridge is defective or not intended for use in this device.

Solution: Replace the indicated ink cartridge(s) immediately so that you can resume printing. If there are no ink cartridges missing from the HP All-in-One, the ink cartridge contacts might need to be cleaned.

If there are no ink cartridges missing from the HP All-in-One, and you still receive this message after cleaning the ink cartridge contacts, you might have a damaged ink cartridge. Contact HP support. Go to:

www.hp.com/support

If prompted, choose your country/region, and then click **Contact HP** for information on calling for technical support.

For more information, see:

[“Replace the ink cartridges” on page 99](#)

Cause: The wrong ink cartridge(s) are installed.

Solution: The first time you set up and use the HP All-in-One, make sure to install the ink cartridges that were shipped with your device. The ink in these ink cartridges is specially formulated to mix with the ink in the print head assembly.

To resolve this error, replace the affected ink cartridge(s) with the ink cartridges that were shipped with the HP All-in-One.

For more information, see:

[“Replace the ink cartridges” on page 99](#)

15 HP warranty and support

Hewlett-Packard provides Internet and phone support for the HP All-in-One.

This section contains the following topics:

- [Warranty](#)
- [Ink cartridge warranty information](#)
- [Support process](#)
- [Before you call HP support](#)
- [HP support by phone](#)
- [Additional warranty options](#)
- [HP Quick Exchange Service \(Japan\)](#)
- [HP Korea customer support](#)
- [Prepare the HP All-in-One for shipment](#)
- [Pack the HP All-in-One](#)

Warranty

For more information about the warranty, see the printed documentation that came with the HP All-in-One.

Ink cartridge warranty information

The HP cartridge warranty is applicable when the product is used in its designated HP printing device. This warranty does not cover HP ink products that have been refilled, remanufactured, refurbished, misused, or tampered with.

During the warranty period the product is covered as long as the HP ink is not depleted and the end of warranty date has not been reached. The end of warranty date, in YYYY/MM/DD format, may be found on the product as indicated:

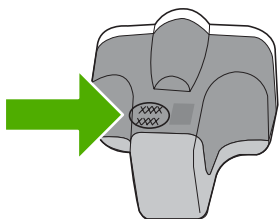

For a copy of the HP Limited Warranty Statement, see the printed documentation that came with the HP All-in-One.

Support process

If you have a problem, follow these steps:

1. Check the documentation that came with the HP All-in-One.
2. Visit the HP online support Web site at www.hp.com/support. HP online support is available to all HP customers. It is the fastest source for up-to-date device information and expert assistance and includes the following features:
 - Fast access to qualified online support specialists
 - Software and driver updates for the HP All-in-One
 - Valuable HP All-in-One and troubleshooting information for common problems
 - Proactive device updates, support alerts, and HP newsgroups that are available when you register the HP All-in-One
3. Call HP support. Support options and availability vary by device, country/region, and language.

Before you call HP support

Software programs from other companies might be included with the HP All-in-One. If you experience problems with any of those programs, you will receive the best technical assistance by calling the experts at that company.



NOTE: This information does not apply to customers in Japan. For information on service options in Japan, see [“HP Quick Exchange Service \(Japan\)”](#) on page 172.

If you need to contact HP support, do the following before you call:

1. Make sure that:
 - a. The HP All-in-One is plugged in and turned on.
 - b. The specified ink cartridges are installed correctly.
 - c. The recommended paper is properly loaded in the input tray.
2. Reset the HP All-in-One:
 - a. Turn off the HP All-in-One by pressing the **On** button.
 - b. Unplug the power cord from the back of the HP All-in-One.
 - c. Plug the power cord back into the HP All-in-One.
 - d. Turn on the HP All-in-One by pressing the **On** button.
3. To find support and warranty information, go to the HP Web site at www.hp.com/support. If prompted, choose your country/region, and then click **Contact HP** for information on calling for technical support.
Check the HP Web site for updated information or troubleshooting tips for the HP All-in-One .
4. If you are still experiencing problems and need to speak with an HP support representative, do the following:
 - a. Have the specific name of the HP All-in-One, as it appears on the control panel, available.
 - b. Print a self-test report.
 - c. Make a color copy to have available as a sample printout.
 - d. Be prepared to describe your problem in detail.
 - e. Have your serial number ready.
You can view the serial number by looking at the sticker on the rear side of the HP All-in-One. The serial number is the 10-character code in the upper left corner of the sticker.
5. Call HP support. Be near the HP All-in-One when you call.

Related topics

[“Print a self-test report”](#) on page 95

HP support by phone

For a list of support phone numbers, see the printed documentation that came with the device.

This section contains the following topics:

- [Phone support period](#)
- [Placing a call](#)
- [After the phone support period](#)

Phone support period

One year of phone support is available in North America, Asia Pacific, and Latin America (including Mexico). To determine the duration of phone support in Europe, the Middle East, and Africa, go to www.hp.com/support. Standard phone company charges apply.

Placing a call

Call HP support while you are in front of the computer and the HP All-in-One. Be prepared to provide the following information:

- Model number (located on the label on the front of the HP All-in-One)
- Serial number (located on the back or bottom of the HP All-in-One)
- Messages that appear when the situation occurs
- Answers to these questions:
 - Has this situation happened before?
 - Can you re-create it?
 - Did you add any new hardware or software to your computer at about the time that this situation began?
 - Did anything else occur prior to this situation (such as a thunderstorm, HP All-in-One was moved, etc.)?

After the phone support period

After the phone support period, help is available from HP at an additional cost. Help may also be available at the HP online support Web site: www.hp.com/support. Contact your HP dealer or call the support phone number for your country/region to learn more about support options.

Additional warranty options

Extended service plans are available for the HP All-in-One at additional costs. Go to www.hp.com/support, select your country/region and language, then explore the services and warranty area for information about the extended service plans.

HP Quick Exchange Service (Japan)

インク カートリッジに問題がある場合は以下に記載されている電話番号に連絡してください。インク カートリッジが故障している、または欠陥があると判断された場合、HP Quick Exchange Service がこのインク カートリッジを正常品と交換し、故障したインクカートリッジを回収します。保障期間中は、修理代と配送料は無料です。また、お住まいの地域にもよりますが、プリンタを次の日までに交換することも可能です。

電話番号： 0570-000511 (自動応答)
03-3335-9800 (自動応答システムが使用できない場合)
サポート時間： 平日の午前 9:00 から午後 5:00 まで
土日の午前 10:00 から午後 5:00 まで
祝祭日および 1 月 1 日から 3 日は除きます。

サービスの条件:

- サポートの提供は、カスタマケアセンターを通してのみ行われます。
- カスタマケアセンターがプリンタの不具合と判断した場合に、サービスを受けることができます。

ご注意：ユーザの扱いが不適切であったために故障した場合は、保障期間中であっても修理は有料となります。詳細については保証書を参照してください。

その他の制限:

- 運搬の時間はお住まいの地域によって異なります。詳しくは、カスタマケアセンターに連絡してご確認ください。
- 出荷配送は、当社指定の配送業者が行います。
- 配送は交通事情などの諸事情によって、遅れる場合があります。
- このサービスは、将来予告なしに変更することがあります。

For instructions on how to pack your device for exchange, see [“Pack the HP All-in-One”](#) on page 174.

HP Korea customer support

HP 한국 고객 지원 문의

- 고객 지원 센터 대표 전화
1588-3003
- 제품가격 및 구입처 정보 문의 전화
080-703-0700
- 전화 상담 가능 시간:
평 일 09:00~18:00
토요일 09:00~13:00
(일요일, 공휴일 제외)

Prepare the HP All-in-One for shipment

If, after contacting HP support or returning to the point of purchase, you are requested to send the HP All-in-One in for service, make sure you remove and keep the following items before returning your device:

- The control panel faceplate
- The power cord, USB cable, and any other cable connected to the HP All-in-One

△ CAUTION: The replacement HP All-in-One will not be shipped with a power cord. Store the power cord in a safe place until the replacement HP All-in-One arrives.

- Any paper loaded in the input tray
- Remove any originals you might have loaded in the HP All-in-One

This section contains the following topics:

- [Secure the ink system](#)
- [Remove the control panel faceplate](#)

Secure the ink system

Contact HP support for information about how you should secure the ink system to prevent ink from leaking in the HP All-in-One during shipment. They might instruct you to replace the ink cartridges with replacement ink cartridges.

If you receive a replacement HP All-in-One, refer to the instructions included in the box for information about how to secure the ink system. The replacement HP All-in-One might come with ink cartridges that you can use to install in your device to prevent the ink system from leaking during shipment.

 **NOTE:** This information does not apply to customers in Japan. For information on service options in Japan, see "[HP Quick Exchange Service \(Japan\)](#)" on page 172.

Related topics

["Replace the ink cartridges" on page 99](#)

Remove the control panel faceplate

Remove the control panel faceplate before returning the HP All-in-One for repair.

 **NOTE:** This information does not apply to customers in Japan. For information on service options in Japan, see "[HP Quick Exchange Service \(Japan\)](#)" on page 172.

△ CAUTION: The HP All-in-One must be unplugged before following these steps.

To remove the control panel faceplate

1. Press the **On** button to turn off the HP All-in-One.
2. Unplug the power cord, and then disconnect it from the HP All-in-One. Do not return the power cord with the HP All-in-One.
3. Remove the control panel faceplate as follows:
 - a. Place your hands on each side of the control panel faceplate.
 - b. Place the fingertips of your left hand in the small gap under the display, and then pry the faceplate down and to the right.

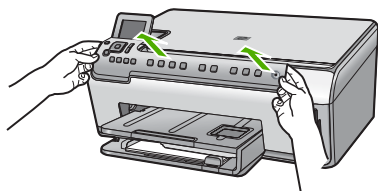

4. Retain the control panel faceplate. Do not return the control panel faceplate with the HP All-in-One.

⚠ CAUTION: The replacement HP All-in-One might not come with a control panel faceplate. Store your control panel faceplate in a safe place, and when the replacement HP All-in-One arrives, reattach your control panel faceplate. You must attach your control panel faceplate to use the control panel functions on the replacement HP All-in-One.

📖 NOTE: See the Setup Guide that came with the HP All-in-One for instructions on how to attach your control panel faceplate. The replacement HP All-in-One might come with instructions for setting up your device.

Pack the HP All-in-One

Complete the following steps after you have prepared the HP All-in-One for shipment.

To pack the HP All-in-One

1. If available, pack the HP All-in-One for shipment by using the original packing materials or the packaging materials that came with your exchange device.

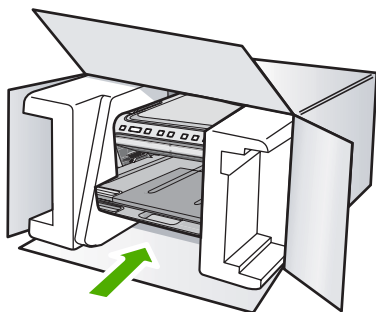

If you do not have the original packaging materials, please use other adequate packaging materials. Shipping damage caused by improper packaging and/or improper transportation is not covered under the warranty.

2. Place the return shipping label on the outside of the box.
3. Include the following items in the box:
 - A complete description of symptoms for service personnel (samples of print quality problems are helpful).
 - A copy of the sales slip or other proof of purchase to establish the warranty coverage period.
 - Your name, address, and a phone number where you can be reached during the day.

16 Technical information

The technical specifications and international regulatory information for the HP All-in-One are provided in this section.

For additional specifications, see the printed documentation that came with the HP All-in-One.

This section contains the following topics:

- [Specifications](#)
- [Environmental product stewardship program](#)
- [Regulatory notices](#)

Specifications

Technical specifications for the HP All-in-One are provided in this section. For additional specifications, see the printed documentation that came with the HP All-in-One.

System requirements

Software and system requirements are located in the Readme file.

For information about future operating system releases and support, visit the HP online support Web site at www.hp.com/support.

Paper specifications

Type	Paper weight	Input tray*	Output tray†	Photo tray*
Plain paper	20 to 24 lb. (75 to 90 gsm)	Up to 125 (20 lb. paper)	50 (20 lb. paper)	n/a
Legal paper	20 to 24 lb. (75 to 90 gsm)	Up to 125 (20 lb. paper)	50 (20 lb. paper)	n/a
Cards	110 lb. index max (200 gsm)	Up to 40	25	Up to 20
Envelopes	20 to 24 lb. (75 to 90 gsm)	Up to 15	15	n/a
Transparency film	N/A	Up to 40	25	n/a
Labels	N/A	Up to 40	25	n/a
5 x 7 inch (13 x 18 cm) Photo paper	145 lb. (236 gsm)	Up to 20	20	n/a
4 x 6 inch (10 x 15 cm) Photo paper	145 lb. (236 gsm)	Up to 20	20	20 to 25
8.5 x 11 inch (216 x 279 mm) Photo paper	N/A	Up to 40	25	n/a

* Maximum capacity.

† Output tray capacity is affected by the type of paper and the amount of ink you are using. HP recommends emptying the output tray frequently.

* Maximum capacity.



NOTE: For a complete list of supported media sizes, see the printer driver.

Print specifications

- Up to 1200 x 1200 rendered dpi black when printing from a computer
- Up to 4800 x 1200 optimized dpi color when printing from a computer and 1200-input dpi
- Print speeds vary according to the complexity of the document
- Panorama-size printing
- Method: drop-on-demand thermal inkjet
- Language: PCL3 GUI
- Duty cycle: Up to 3000 printed pages per month

Copy specifications

- Digital image processing
- Up to 9 copies from original (depends on model)
- Copy speeds vary according to the complexity of the document and model
- Maximum copy enlargement ranging from 200-400% (depends on model)
- Maximum copy reduction ranging from 25-50% (depends on model)

Scan specifications

- Image editor included
- Integrated OCR software automatically converts scanned text to editable text (if installed)
- Twain-compliant software interface
- Resolution: up to 4800 x 4800 ppi optical (depends on model); 19200 ppi enhanced (software)
For more information about ppi resolution, see the scanner software.
- Color: 48-bit color, 8-bit grayscale (256 levels of gray)
- Maximum scan size from glass: 21.6 x 29.7 cm (8.5 x 11.7 inches)

Print resolution

To find out about the printer resolution, see the printer software. For more information, see [“View the print resolution”](#) on page 48.

Ink cartridge yield

Visit www.hp.com/pageyield for more information on estimated cartridge yields.

Acoustic information

If you have Internet access, you can get acoustic information from the HP Web site. Go to: www.hp.com/support.

Environmental product stewardship program

Hewlett-Packard is committed to providing quality products in an environmentally sound manner. Design for recycling has been incorporated into this product. The number of materials has been kept to a minimum while ensuring proper functionality and reliability. Dissimilar materials have been designed to separate easily. Fasteners and other connections are easy to locate, access, and remove using common tools. High priority parts have been designed to access quickly for efficient disassembly and repair.

For more information, visit HP's Commitment to the Environment Web site at:

www.hp.com/hpinfo/globalcitizenship/environment/index.html

This section contains the following topics:

- [Paper use](#)
- [Plastics](#)
- [Material safety data sheets](#)
- [Recycling program](#)

- [HP inkjet supplies recycling program](#)
- [Energy Star® notice](#)
- [Special handling of materials](#)
- [Attention California users](#)
- [Battery disposal in the Netherlands](#)
- [Battery disposal in Taiwan](#)
- [Disposal of waste equipment by users in private households in the European Union](#)

Paper use

This product is suited for the use of recycled paper according to DIN 19309 and EN 12281:2002.

Plastics

Plastic parts over 25 grams are marked according to international standards that enhance the ability to identify plastics for recycling purposes at the end of product life.

Material safety data sheets

Material safety data sheets (MSDS) can be obtained from the HP Web site at:

www.hp.com/go/msds

Recycling program

HP offers an increasing number of product return and recycling programs in many countries/regions, and partners with some of the largest electronic recycling centers throughout the world. HP conserves resources by reselling some of its most popular products. For more information regarding recycling of HP products, please visit:

www.hp.com/hpinfo/globalcitizenship/environment/recycle/

HP inkjet supplies recycling program

HP is committed to protecting the environment. The HP Inkjet Supplies Recycling Program is available in many countries/regions, and lets you recycle used print cartridges and ink cartridges free of charge. For more information, go to the following Web site:

www.hp.com/hpinfo/globalcitizenship/environment/recycle/

Energy Star® notice

This product is designed to reduce power consumption and save natural resources without compromising product performance. It has been designed to reduce total energy consumption both during operation and when the device is not active. This product qualifies for ENERGY STAR® which is a voluntary program established to encourage the development of energy-efficient office products.



ENERGY STAR is a U.S. registered service mark of the U.S. EPA. As an ENERGY STAR partner, HP has determined that this product meets ENERGY STAR guidelines for energy efficiency.

For more information on ENERGY STAR guidelines, go to the following Web site:

www.energystar.gov

Special handling of materials

This HP product contains a lithium-manganese dioxide battery located on the main printed circuit assembly that may require special handling at end-of-life.

Attention California users

The battery supplied with this product may contain perchlorate material. Special handling may apply. For more information, go to the following Web site:

www.dtsc.ca.gov/hazardouswaste/perchlorate

Battery disposal in the Netherlands

 <p>Batterij niet weggoien, maar inleveren als KCA.</p>	Dit HP Product bevat een lithium-manganese-dioxide batterij. Deze bevindt zich op de hoofdprintplaat. Wanneer deze batterij leeg is, moet deze volgens de geldende regels worden afgevoerd.
--	---

Battery disposal in Taiwan

 <p>廢電池請回收</p> <p>Please recycle waste batteries.</p>
--

This section contains the following topics:

- [Regulatory model identification number](#)
- [FCC statement](#)
- [Notice to users in Korea](#)
- [VCCI \(Class B\) compliance statement for users in Japan](#)
- [Notice to users in Japan about the power cord](#)
- [Noise emission statement for Germany](#)
- [Toxic and hazardous substance table](#)
- [Declaration of conformity \(European Economic Area\)](#)
- [HP Photosmart C6200 All-in-One series declaration of conformity](#)

Regulatory model identification number

For regulatory identification purposes, your product is assigned a Regulatory Model Number. The Regulatory Model Number for your product is SDGOB-0714. This regulatory number should not be confused with the marketing name (HP Photosmart C6200 All-in-One series, etc.) or product numbers (CC985A, etc.).

FCC statement

FCC statement

The United States Federal Communications Commission (in 47 CFR 15.105) has specified that the following notice be brought to the attention of users of this product.

This equipment has been tested and found to comply with the limits for a Class B digital device, pursuant to Part 15 of the FCC Rules. These limits are designed to provide reasonable protection against harmful interference in a residential installation. This equipment generates, uses and can radiate radio frequency energy and, if not installed and used in accordance with the instructions, may cause harmful interference to radio communications. However, there is no guarantee that interference will not occur in a particular installation. If this equipment does cause harmful interference to radio or television reception, which can be determined by turning the equipment off and on, the user is encouraged to try to correct the interference by one or more of the following measures:

- Reorient the receiving antenna.
- Increase the separation between the equipment and the receiver.
- Connect the equipment into an outlet on a circuit different from that to which the receiver is connected.
- Consult the dealer or an experienced radio/TV technician for help.

For further information, contact:

Manager of Corporate Product Regulations
 Hewlett-Packard Company
 3000 Hanover Street
 Palo Alto, Ca 94304
 (650) 857-1501

Modifications (part 15.21)

The FCC requires the user to be notified that any changes or modifications made to this device that are not expressly approved by HP may void the user's authority to operate the equipment.

This device complies with Part 15 of the FCC Rules. Operation is subject to the following two conditions: (1) this device may not cause harmful interference, and (2) this device must accept any interference received, including interference that may cause undesired operation.

Notice to users in Korea

사용자 안내문(B급 기기)

이 기기는 비업무용으로 전자파 적합 등록을 받은 기기로서, 주거지역에서는 물론 모든 지역에서 사용할 수 있습니다.

VCCI (Class B) compliance statement for users in Japan

この装置は、情報処理装置等電波障害自主規制協議会（VCCI）の基準に基づくクラスB情報技術装置です。この装置は、家庭環境で使用することを目的としていますが、この装置がラジオやテレビジョン受信機に近接して使用されると受信障害を引き起こすことがあります。

取り扱い説明書に従って正しい取り扱いをして下さい。

Notice to users in Japan about the power cord

製品には、同梱された電源コードをお使い下さい。

同梱された電源コードは、他の製品では使用出来ません。

Noise emission statement for Germany

Geräuschemission

LpA < 70 dB am Arbeitsplatz im Normalbetrieb nach DIN 45635 T. 19

Toxic and hazardous substance table

零件描述		有毒有害物质和元素					
		铅	汞	镉	六价铬	多溴联苯	多溴联苯醚
外壳和托盘	0	0	0	0	0	0	
电线	0	0	0	0	0	0	
印刷电路板	X	0	0	0	0	0	
打印系统	X	0	X	0	0	0	
显示器**	X	0	0	0	0	0	
喷墨打印机墨盒**	X	0	0	0	0	0	
扫描仪**	X	0	0	0	0	0	
外部电源**	X	0	0	0	0	0	

0: 指此部件的所有均一材质中包含的这种有毒有害物质，含量低于SJ/T11363-2006的限制
X: 指此部件使用的均一材质中至少有一种包含的这种有毒有害物质，含量高于SJ/T11363-2006的限制
注：环保使用期限的参考标识取决于产品正常工作的温度和湿度等条件
**以上只适用于使用这些部件的产品

Declaration of conformity (European Economic Area)

The Declaration of Conformity in this document complies with ISO/IEC 17050-1 and EN 17050-1. It identifies the product, manufacturer's name and address, and applicable specifications recognized in the European community.

HP Photosmart C6200 All-in-One series declaration of conformity

		DECLARATION OF CONFORMITY according to ISO/IEC 17050-1 and EN 17050-1
Supplier's Name:	Hewlett-Packard Company	DoC#: SDGOB-0714-rel.2.0
Supplier's Address:	16399 West Bernardo Drive San Diego, CA 92127-1899, USA	
declares, that the product		
Product Name and Model:	HP Photosmart C6200 Series (CC985A)	
Regulatory Model Number:¹⁾	SDGOB-0714	
Product Options:	ALL	
Power Adapter:	0957-2230	
conforms to the following Product Specifications and Regulations:		
EMC:	CISPR 22:1997+A1:2000+A2:2002 / EN 55022:1998 +A1:2000+A2:2003 Class B CISPR 24:1997+A1:2001+A2:2002 / EN 55024:1998 +A1:2001+A2:2003 Class B EN 301 489-1 V1.4.1:2002 / EN 301 489-17 V1.2.1:2002 IEC 61000-3-2:2000+A1:2000+A2:2005 / EN 61000-3-2:2000+A2:2005 IEC 61000-3-3:1994+A1:2001 / EN 61000-3-3:1995+A1:2001 FCC Title 47 CFR, Part 15 Class B / ICES-003, Issue 4 GB9254:1998, GB17625.1:2003	
SAFETY:	IEC 60950-1:2001 / EN 60950-1:2001 IEC 60825-1 Ed. 1.2:2001 / EN 60825-1+A2+A1:2002 (LED) GB4943:2001	
<p>This Device complies with Part 15 of the FCC Rules. Operation is subject to the following two Conditions: (1) this device may not cause harmful interference, and (2) this device must accept any interference received, including interference that may cause undesired operation</p> <p>The product herewith complies with the requirements of the EMC Directive 2004/108/EC and the Low Voltage Directive 2006/95/EC and carries the CE-Marking accordingly</p>		
Additional Information:		
<p>1. This product is assigned a Regulatory Model Number which stays with the regulatory aspects of the design. The Regulatory Model Number is the main product identifier in the regulatory documentation and test reports, this number should not be confused with the marketing name or the product numbers.</p>		
San Diego, CA, USA 16 January, 2007		
Local contact for regulatory topics only:		
EMEA:	Hewlett-Packard GmbH, HQ-TRE, Herrenberger Strasse 140, 71034 Böblingen, Germany	
U.S.:	Hewlett-Packard, 3000 Hanover St., Palo Alto 94304, U.S.A. 650-857-1501	

Index

Symbols/Numerics

- 10 x 15 cm photo paper
 - copy 86
 - load 38
 - specifications 175
- 2 pages on 1, print 57
- 4 pages on 1, print 57
- 4 x 6 inch (10 x 15 cm)
 - borderless photos
 - print 53
- 4 x 6 inch photo paper
 - copy 86
- 4 x 6 inch photo paper, load 38
- 802.3 wired, configuration
 - page 27

A

- A4 paper, load 37
- addresses, print 60
- admin password 27
- advanced network settings 23
- after the support period 171
- align printer 102

B

- best copy quality 88
- blank
 - copy 149
 - scan 143
- blocked print head 116
- booklet printing 56
- borderless copies 90
- borderless photos
 - copy has borders 148
 - crop is wrong 149
 - print 53
- brightness, change in print 49
- Browsing photos 16
- buttons, control panel 7

C

- cancel
 - button 7
 - copy 93
 - print job 62
 - scan 83

- cartridges. See ink cartridges
- CAT-5 Ethernet cable 20
- choose paper 34
- clean
 - exterior 98
 - glass 97
 - ink cartridge contacts 104
 - lid backing 98
 - print head 103
- color
 - dull 128
 - smearred 126
- color graphics display
 - copy preview 85
 - crop original 92
 - shift margin 92
- color tone, change in print 49
- communication problems
 - test failed 159
 - two-way communication
 - lost 161
- config source (802.3 wired) 28
- configuration page
 - 802.3 wired 27
 - general information 27
- connect
 - wired network (Ethernet) 19
- connection problems
 - device not found 160
 - HP All-in-One does not turn on 113
- connection types supported
 - Ethernet 18
 - printer sharing 18
- control panel
 - buttons 7
 - features 7
 - overview 6
- copy
 - blank 149
 - borderless has borders 148
 - borderless photo 90
 - cancel 93
 - crop 92
 - crop is wrong 149
 - default settings 89
 - enlarge 91
 - fit to page fails 147
 - make a copy 85
 - margin shift 92
 - menu 11
 - missing information 147
 - number of copies 86
 - paper size 86
 - paper types,
 - recommended 87
 - photos, enhance 92
 - preview 85
 - quality 88
 - reduce 91
 - size, custom 91
 - smearred 126
 - specifications 176
 - speed 88
 - text, enhance 92
 - too dark 146
 - too light 146
 - troubleshooting 145
- country/region, set 15
- crop
 - borderless copy is wrong 149
 - fails 154
 - crop an original 92
 - crop photos 73
 - customer support
 - warranty 169, 171

D

- damaged, ink cartridge 163
- dark copy 146
- darken
 - copies 89
- declaration of conformity
 - European Economic Area 182
 - United States 182
- default gateway (802.3 wired) 28
- default printer, set as 46
- default settings
 - restore 16

- default settings, restore 23
 - device
 - no response 132
 - not found 160
 - direction pad 8
 - disconnected error 155
 - Display
 - icons 8
 - display
 - change language 114
 - change measurements 114
 - sleep state 9
 - DNS server (802.3 wired) 28
 - documents
 - edit scanned 82
 - scan 79
 - double-sided prints 55, 56
 - DPOF printing 16
- E**
- edit
 - scan preview 82
 - edit scanned images 82
 - Embedded Web Server
 - access using web browser 25
 - password settings 27
 - envelopes
 - load 40
 - specifications 175
 - environment
 - Environmental product stewardship program 176
 - error messages
 - memory cards 154
 - out of paper 158
 - reading or writing file 152
 - European Union
 - Directive 2002/95/EC 178
 - EWS. *See* Embedded Web Server
- F**
- factory defaults, restore 16
 - fast copy quality 88
 - fax
 - paper width incorrect 159
 - poor quality printouts 124, 125
 - fax problems
 - poor print quality 125
 - smear ink 124
- G**
- file
 - invalid name 153
 - supported formats 153
 - unreadable 152
 - unsupported formats 153
 - firmware revision mismatch 150
 - firmware version 27
 - fit to page 91
 - fit to page fails 147
- G**
- gateway, default setting 28
 - general information, configuration page 27
 - glass
 - clean 97
 - greeting cards, load 42
- H**
- Hagaki, load 39
 - hardware address (802.3 wired) 27
 - help
 - menu 10
 - hostname 27, 29
 - HP Instant Share
 - send a scan 83
 - HP Photosmart
 - send images 70
- I**
- images
 - crop 73
 - edit scanned 82
 - rotate 73
 - scan 79
 - send a scan 83
 - zoom 73
 - improper shutdown 161
 - index cards, load 39
 - ink
 - drying time 158
 - empty 164
 - low 138
 - replace soon 167
 - sprays inside device 131
 - sprays inside HP All-in-One 138
 - ink cartridge
 - failure 164
 - ink cartridges
 - check ink levels 98
 - clean contacts 104
 - damaged 163
 - empty 164
 - error message 168
 - error messages 161
 - expired 164
 - HP ink depleted 165
 - incompatible 162
 - incorrect 162, 163, 167, 168
 - missing 163
 - non-HP ink 165
 - order 107
 - replace 99
 - replace soon 167
 - supply error 165
 - tips 110
 - troubleshoot 115
- ink levels
- icons 8
- ink levels, check 98
- ink supplies
- purchase 107
- ink, removing ink from skin and clothing 106
- invalid file name 153
- IP
 - address 27, 28
 - settings 24
- iron-on transfers 59
- J**
- jams, paper 43, 116
- L**
- labels
 - load 42
 - specifications 175
 - landscape orientation 49
 - language, set 15
 - left arrow 8
 - legal paper
 - copy 86
 - load 37
 - specifications 175
 - letter paper
 - copy 87
 - load 37
 - specifications 175
 - lid backing, clean 98
 - light
 - copy 146

Index

- lighten
 - copies 89
- link
 - configuration 28
 - speed 24
- load
 - 10 x 15 cm photo paper 38
 - 4 x 6 inch photo paper 38
 - A4 paper 37
 - envelopes 40
 - full-size paper 37
 - greeting cards 42
 - Hagaki 39
 - index cards 39
 - iron-on transfers 42
 - labels 42
 - legal paper 37
 - letter paper 37
 - original 33
 - postcards 39
 - transparencies 42
- M**
- MAC address 27
- maintenance
 - align printer 102
 - check ink levels 98
 - clean exterior 98
 - clean glass 97
 - clean lid backing 98
 - clean print head 103
 - replace ink cartridges 99
 - restore factory defaults 16
 - self-test report 95
 - Standby/Off, set mode 106
- make a copy 85
- margins
 - incorrect 136
 - text or graphic cut off 137
- maximum resolution quality 88
- mDNS service name 27
- media. *See* paper
- Media Access Control (MAC)
 - address 27
- memory cards
 - digital camera cannot read 139
 - e-mail photos 70
 - error message 154
 - file unreadable 152
 - HP All-in-One cannot read 139
 - inaccessible 141
- insert 71
- photos missing 152
- read or write error 141
- save files to computer 71
- scan to 81
- share photos 70
- slots 65
- troubleshoot 139
- menus
 - copy 11
 - help 10
 - scan to 10
 - setup 10
- missing
 - information from copy 147
 - ink cartridge 163
 - text from scan 145
- N**
- network
 - advanced settings 23
 - connection type 27
 - restore settings 23
 - status 27
 - upgrade 22
- network configuration page 26
- no scan options error 155
- normal copy quality 88
- number of copies 86
- O**
- OK button 8
- on button 8
- order
 - ink cartridges 107
 - ink supplies 107
- out of paper 158
- overheads, print 59
- P**
- page order 58
- paper
 - choose 34
 - feed fails 131
 - incompatible types 36
 - jam 150, 158
 - jams 43, 111, 116
 - load 36
 - misfeed 158
 - out of 158
 - paper mismatch 159
 - photo 159
- recommended copy types 87
- recommended sizes for printing 46
- recommended types 34, 35
- size incorrect 159
- specifications 175
- tips 111
- type incorrect 159
- width incorrect 159
- paper size
 - copy setting 86
- paper type 47
- password, Embedded Web Server 27
- phone numbers, support 170
- phone support 171
- phone support period
 - period for support 171
- photo
 - photosmart express menu 10
- Photo browsing 16
- photo paper
 - copy 87
 - load 38
 - specifications 175
- photos
 - add a frame 72
 - add color effect 72
 - adjust brightness 72
 - crop 73
 - e-mail 70
 - edit scanned 82
 - flip horizontal 72
 - ink sprays 138
 - missing 152
 - print borderless 53
 - print on photo paper 53
 - remove red-eye 72
 - rotate 73
 - send using HP Photosmart 70
 - share 70
 - zoom 73
- Photosmart Express 7
- poor fax printout quality 124, 125
- portrait orientation 49
- postcards
 - load 39
- posters 61
- preview copy 85

- preview image, edit 82
- preview print job 50
- print
 - 2 or 4 pages on 1 57
 - addresses 60
 - blank printout 138
 - booklet 56
 - borderless fails 132
 - borderless photos 53
 - both sides of page 55
 - cancel job 62
 - CD/DVD labels 54
 - correct order 58
 - distorted printout 126
 - envelopes 60
 - envelopes print
 - incorrectly 131
 - faded 128
 - from computer 45
 - from software application 45
 - iron-on transfers 59
 - labels 60
 - margins incorrect 136, 137
 - meaningless characters 134
 - multiple pages on one
 - sheet 57
 - nothing happens 134
 - on photo paper 53
 - posters 61
 - preview 50
 - print options 46, 50
 - quality, troubleshoot 124, 125, 127, 129
 - reverse images 59
 - reversed page order 136
 - self-test report 95
 - special print jobs 52
 - specifications 176
 - transparencies 59
 - troubleshooting 131
 - vertical streaks 130
 - Web pages 61
- print cartridges
 - low ink 138
- print head
 - clean 103
 - failure 166
 - stalled 166
- print head, blocked 116
- print quality 48
- print settings
 - brightness 49
 - color tone 49
 - layout 49
 - orientation 49
 - paper size 46
 - paper type 47
 - print quality 123
 - quality 48
 - reduce/enlarge 49
 - resizing options 49
 - resolution 48
 - saturation 49
 - speed 48
- printer found screen,
 - Windows 21
- printer sharing
 - Mac 18
 - Windows 18
- printer, align 102
- Printing Shortcuts tab 51
- problems
 - copy 145
 - error messages 149
 - print 131
 - scan 142
- Q**
 - quality
 - print 48
 - quality, copy 88
- R**
 - recycle
 - ink cartridges 177
 - red-eye, remove 72
 - reduce/enlarge copies
 - custom size 91
 - resize to fit letter or A4 91
 - regulatory notices
 - China 178
 - declaration of conformity (European Economic Area) 182
 - declaration of conformity (U.S.) 182
 - Directive 2002/95/EC 178
 - regulatory model
 - identification number 180
 - reinstall software 118
 - removing ink from skin and clothing 106
 - replace ink cartridges 99
 - reports
 - self-test 95
 - resolution
 - print 48
 - restore factory settings 16
 - restore network defaults 23
 - right arrow 7
 - RJ-45 plug 20, 29, 30
 - rotate photos 73
- S**
 - saturation, change in print 49
 - save
 - photos to computer 71
 - scanned image 80
 - scan
 - blank 143
 - button 8
 - cancel 83
 - crop incorrect 144
 - documents 79, 80
 - edit image 82
 - fails 143, 150
 - features 79
 - from control panel 80
 - halts 143
 - no scan options error 155
 - page layout incorrect 144
 - photos 79, 80
 - preview image, edit 82
 - save to computer 80
 - save to memory card 81
 - scan specifications 176
 - send using HP Photosmart
 - Share 83
 - share images 83
 - stop 83
 - text appears as dotted
 - lines 144
 - text format incorrect 144
 - text incorrect 145
 - to memory card 81
 - troubleshooting 142
 - scan glass
 - clean 97
 - scan to
 - menu 10
 - security
 - network, WEP key 21
 - self-test report 95
 - send images using HP Photosmart Share
 - scanned image 83
 - set
 - print options 46, 50

Index

- settings
 - country/region 15
 - language 15
 - network 22
 - restore defaults 23
 - setup
 - button 7
 - menu 10
 - sharing 22
 - shift left margin 92
 - ship your device 173
 - sleep state 9
 - smear ink, fax 124
 - software application, print
 - from 45
 - software installation
 - reinstall 118
 - troubleshoot 116
 - uninstall 118
 - speed
 - copy 88
 - print 48
 - start copy black 8
 - start copy color 8
 - status, network 27
 - stop
 - copy 93
 - print job 62
 - scan 83
 - Store Demo 17
 - subnet mask 28
 - support
 - contact 170
 - support process 170
 - system requirements 175
- T**
- T-shirt transfers. *See* iron-on transfers
 - technical information
 - copy specifications 176
 - paper specifications 175
 - print specifications 176
 - scan specifications 176
 - system requirements 175
 - telephone numbers, support 170
 - text
 - cut off 137
 - dotted lines on scan 144
 - enhance on copies 92
 - incorrect format on scan 144
 - incorrect or missing on scan 145
 - jagged 126
 - meaningless characters 134
 - not filled in 125
 - smooth fonts 126
 - Tips Slideshow 17
 - total packets received (802.3 wired) 29
 - total packets transmitted (802.3 wired) 28
 - transparencies
 - copy 87
 - load 42
 - specifications 175
 - Tray selection 16
 - troubleshoot
 - blocked print head 116
 - fax problems 124, 125
 - hardware installation 112
 - incorrect
 - measurements 114
 - jams, paper 43, 116
 - language, display 114
 - network setup 120
 - printer alignment 115
 - software installation 116
 - USB cable 114
 - troubleshooting
 - cannot find the file or item 142
 - communication problems 109
 - copy 145
 - error messages 149
 - filename appears as gibberish 141
 - memory card 139
 - others on network can access my memory card 142
 - print 131
 - Printer not Found 122
 - scan 142
 - unable to discover device 121
 - two-sided prints 55, 56
- U**
- uninstall software 118
 - upgrade to network 22
 - URL 27
- W**
- USB cable
 - communication lost 161
 - USB cable installation 114
 - warranty 169, 171
 - Web pages, print 61
- Z**
- zoom
 - button 8
 - buttons 73
 - photos 73

