

# HP Photosmart C7200 All-in-One series

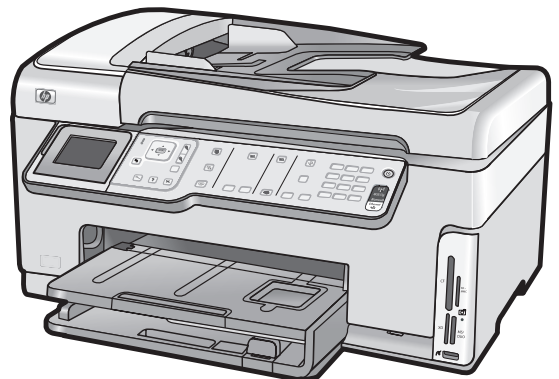

Windows Help



# Contents

<b>1</b>	<b>HP Photosmart C7200 All-in-One series Help</b>	<b>9</b>
<b>2</b>	<b>HP All-in-One overview</b>	
	The HP All-in-One at a glance	11
	Control panel overview	12
	Control panel features	13
	Display icons	14
	Display sleep state	15
	Menu overview	15
	Photosmart Express Menu	16
	Copy Menu	16
	Scan Menu	17
	Fax Menu	17
	Setup Menu	17
	Help Menu	18
	Text and symbols	18
	Enter text using the keypad on the control panel	18
	Enter text using the visual keyboard	19
	Available symbols for dialing fax numbers	20
	Use the HP Photosmart Software	21
<b>3</b>	<b>Find more information</b>	<b>23</b>
<b>4</b>	<b>Finish setting up the HP All-in-One</b>	
	Set your preferences	25
	General preferences	25
	Set your language and country/region	25
	Set the date and time	26
	Adjust the volume	26
	Set the default paper tray for PictBridge/DPOF/uPnP printing	27
	Enable faster browsing of photos	27
	Set the paper tray for printing from a Bluetooth device	27
	Restore the factory defaults	28
	Play a slideshow on the display	28
	Fax preferences	29
	Set up the HP All-in-One to redial a fax number automatically	29
	Set tone or pulse dialing	29
	Set the fax speed	30

Computer connection information.....	30
Supported connection types.....	31
Connect using Ethernet.....	31
Connect using integrated wireless WLAN 802.11.....	32
Connect using the HP bt450, Printer and PC Adapter with Bluetooth® Wireless Technology.....	32
Find the device name and address.....	32
Set Bluetooth security for the HP All-in-One.....	33
Use a Bluetooth® connection to print from your computer.....	34
Use printer sharing.....	36
Connect to a network.....	36
Wired network setup.....	37
What you need for a wired network.....	38
Connect the HP All-in-One to the network.....	38
Integrated wireless WLAN 802.11 network setup.....	39
What you need for an integrated wireless WLAN 802.11 network.....	40
Connect to an integrated wireless WLAN 802.11 network.....	40
Wireless ad hoc network setup.....	43
What you need for an ad hoc network.....	43
Create a network profile for a Windows XP computer.....	43
Create a network profile for other operating systems.....	45
Connect to a wireless ad hoc network.....	45
Install the software for a network connection.....	46
Connect to additional computers on a network.....	47
Change the HP All-in-One from a USB connection to a network connection.....	47
Manage your network settings.....	48
Change basic network settings from the control panel.....	48
Change advanced network settings from the control panel settings.....	50
Use the Embedded Web Server.....	52
Network configuration page definitions.....	53
Network glossary.....	59
Fax setup.....	61
Change settings on the HP All-in-One to receive faxes.....	62
Set the answer mode.....	62
Set the number of rings before answering.....	62
Change the answer ring pattern for distinctive ringing.....	63
Test your fax setup.....	63
Set the fax header.....	64
Set up speed dialing.....	65
Set up individual speed dial entries.....	65
Set up group speed dial entries.....	66
Delete speed dial entries.....	67
Print the speed dial list.....	67
<b>5 How do I?.....</b>	<b>69</b>
<b>6 Load originals and load paper</b>	
Load originals.....	71
Load an original in the automatic document feeder.....	71
Load an original on the glass.....	72

Choose papers for printing and copying.....	73
Recommended papers for printing and copying.....	73
Recommended papers for printing only.....	74
Papers to avoid.....	75
Load paper.....	76
Load full-size paper.....	76
Load 10 x 15 cm (4 x 6 inch) photo paper.....	78
Load postcards, Hagaki, or index cards.....	79
Load envelopes.....	80
Load other types of paper.....	81
Avoid paper jams.....	82
<b>7 Print from your computer</b>	
Print from a software application.....	83
Make the HP All-in-One the default printer.....	84
Change the print settings for the current job.....	84
Set the paper size.....	84
Set the paper type for printing.....	85
View the print resolution.....	85
Change the print speed or quality.....	86
Change the page orientation.....	86
Scale the document size.....	87
Change the saturation, brightness, or color tone.....	87
Preview your print job.....	87
Change the default print settings.....	88
Printing shortcuts.....	88
Create printing shortcuts.....	89
Delete printing shortcuts.....	89
Perform special print jobs.....	90
Print a borderless image.....	90
Print a photo on photo paper.....	91
Print custom CD/DVD labels.....	92
Print using <b>Maximum dpi</b> .....	92
Print on both sides of the page.....	93
Print a multiple-page document as a booklet.....	93
Print multiple pages on a single sheet.....	95
Print a multiple-page document in reverse order.....	95
Reverse an image for iron-on transfers.....	96
Print on transparencies.....	96
Print a group of addresses on labels or envelopes.....	97
Print a poster.....	98
Print a Web page.....	98
Stop a print job.....	99
<b>8 Use the photo features</b>	
View and select photos.....	102
Print your photos.....	104
Create special projects from your photos.....	105
Share photos using HP Photosmart Software.....	107
Save photos to your computer.....	108

Edit photos using the control panel.....	109
Zoom and pan to crop a photo.....	109
Rotate a photo.....	110
Adjust the brightness of your photos.....	110
Apply special color effects to your photos.....	111
Remove red-eye.....	112
Automatically enhance your photos.....	112
<b>9 Use the scan features</b>	
Make reprints of your photos.....	115
Scan an image.....	116
Scan an original to a computer.....	117
Scan an original to a memory card or storage device.....	117
Edit a scanned image.....	118
Edit a scanned preview image.....	118
Edit a scanned photo or graphic.....	118
Edit a scanned document.....	118
Share a scanned image with friends and relatives.....	119
Stop scanning.....	119
<b>10 Use the copy features</b>	
Make a copy.....	121
Preview your copy job.....	121
Change the copy settings for the current job.....	122
Set the number of copies.....	122
Set the copy paper size.....	122
Set the copy paper type.....	123
Change copy speed or quality.....	124
Adjust the lightness and darkness of your copy.....	125
Change default copy settings.....	125
Perform special copy jobs.....	126
Make a borderless copy of a photo.....	126
Resize an original to fit onto letter or A4 paper.....	127
Resize an original using custom settings.....	127
Crop an original.....	128
Shift the left margin.....	128
Improve the quality of a copy.....	129
Stop copying.....	129

**11 Use the fax features**

Send a fax.....131

- Send a basic fax.....131
- Send a fax using speed dials.....132
- Send a fax manually from a phone.....133
- Send a fax using monitor dialing.....134
- Scan a fax to send from memory.....135
- Schedule a fax to send later.....135
- Broadcast a fax to multiple recipients .....136
- Send a color original or photo fax.....136
- Change the fax resolution and **Lighter/Darker** settings.....137
  - Change the fax resolution.....137
  - Change the **Lighter/Darker** setting.....138
  - Set new default settings.....139
- Send a fax in Error Correction Mode.....139

Receive a fax.....140

- Receive a fax manually.....140
- Set up backup fax reception.....141
- Reprint received faxes from memory.....142
- Poll to receive a fax.....143
- Forward faxes to another number.....143
- Set the paper size for received faxes.....144
- Set up the HP All-in-One to check the paper type before printing faxes.....144
- Set automatic reduction for incoming faxes.....145
- Block junk fax numbers.....145
  - Set the junk fax mode.....146
  - Add numbers to the junk fax list.....146
  - Remove numbers from the junk fax list.....147

Fax over the Internet using IP phone.....147

Stop faxing.....148

**12 Print reports and forms**

Print reports.....149

- Print a self-test report.....149
- Print fax reports.....150
  - Print fax confirmation reports.....150
  - Print fax error reports.....151
  - Print the fax log.....151
  - Print other reports.....152

Print forms.....153

**13 Maintain the HP All-in-One**

Clean the HP All-in-One.....155

- Clean the glass.....155
- Clean the lid backing.....157
- Clean the exterior.....157

Check the estimated ink levels.....157

Work with ink cartridges.....	158
Replace the ink cartridges.....	159
Align the printer.....	161
Clean the print head.....	162
Clean the ink cartridge contacts.....	163
Remove ink from your skin and clothing.....	164
Self-maintenance sounds.....	165
Reduce energy consumption when the HP All-in-One is off.....	165
Turn off the HP All-in-One.....	165
<b>14 Shop for ink supplies.....</b>	<b>167</b>
<b>15 Troubleshooting</b>	
Troubleshooting tips.....	169
Communication problems over a USB connection.....	169
Information on ink cartridges and the print head.....	170
Information on paper.....	171
Tips for using the automatic document feeder.....	171
Clear paper jams.....	171
Clean the automatic document feeder.....	173
Hardware setup troubleshooting.....	174
Software installation troubleshooting.....	179
Uninstall and reinstall the software.....	181
Network troubleshooting.....	183
Wired network setup troubleshooting.....	183
Wireless setup troubleshooting.....	186
Print quality troubleshooting.....	189
Print troubleshooting.....	200
Memory card and front USB port troubleshooting.....	208
Scan troubleshooting.....	212
Copy troubleshooting.....	215
Fax troubleshooting.....	219
Errors.....	258
Device messages.....	258
File messages.....	261
Supported file types for the HP All-in-One.....	263
General user messages.....	263
Paper messages.....	267
Power and connection messages.....	269
Ink cartridge messages.....	271
<b>16 HP warranty and support</b>	
Warranty.....	279
Ink cartridge warranty information.....	279
Support process.....	280
Before you call HP support.....	280
HP support by phone.....	281
Phone support period.....	281
Placing a call.....	281
After the phone support period.....	281
Additional warranty options.....	281

HP Quick Exchange Service (Japan).....	282
Call HP Korea customer support.....	282
Prepare the HP All-in-One for shipment.....	283
Secure the ink system.....	283
Remove the control panel faceplate.....	283
Pack the HP All-in-One.....	284
<b>17 Technical information</b>	
Specifications.....	287
Duplexer paper specifications.....	289
Environmental product stewardship program.....	289
Paper use.....	290
Plastics.....	290
Material safety data sheets.....	290
Recycling program.....	290
HP inkjet supplies recycling program.....	290
Energy consumption.....	290
Special handling of materials.....	290
Attention California users.....	290
NDL battery disposal.....	290
Taiwan battery statement.....	291
Disposal of Waste Equipment by Users in Private Households in the European Union.....	291
Regulatory notices.....	292
Regulatory model identification number.....	292
FCC statement.....	293
Notice to users of the U.S. telephone network: FCC requirements.....	293
Note à l'attention des utilisateurs du réseau téléphonique canadien/notice to users of the Canadian telephone network.....	294
Notice to users in the European Economic Area.....	296
Notice to users of the German telephone network.....	296
Australia wired fax statement.....	296
Notice to users in Korea.....	296
VCCI (Class B) compliance statement for users in Japan.....	297
Notice to users in Japan about power cord.....	297
Geräuschemission.....	297
Regulatory wireless statements.....	297
Wireless: Exposure to radio frequency radiation.....	297
Wireless: Notice to users in Brazil.....	297
Wireless: Notice to users in Canada.....	298
European Union Regulatory Notice.....	298
Wireless: Notice to users in Taiwan.....	299
Declaration of conformity (European Economic Area).....	299
HP Photosmart C7200 All-in-One series declaration of conformity.....	300
<b>Index.....</b>	<b>301</b>





---

# 1 HP Photosmart C7200 All-in-One series Help

For information about the HP All-in-One, see:

- [“HP All-in-One overview”](#) on page 11
- [“Find more information”](#) on page 23
- [“Finish setting up the HP All-in-One”](#) on page 25
- [“How do I?”](#) on page 69
- [“Load originals and load paper”](#) on page 71
- [“Print from your computer”](#) on page 83
- [“Use the photo features”](#) on page 101
- [“Use the scan features”](#) on page 115
- [“Use the copy features”](#) on page 121
- [“Use the fax features”](#) on page 131
- [“Print reports and forms”](#) on page 149
- [“Maintain the HP All-in-One”](#) on page 155
- [“Shop for ink supplies”](#) on page 167
- [“HP warranty and support”](#) on page 279
- [“Technical information”](#) on page 287



## 2 HP All-in-One overview

Use the HP All-in-One to quickly and easily accomplish tasks such as making a copy, scanning documents, sending and receiving faxes, or printing photos from a memory card. You can access many HP All-in-One functions directly from the control panel, without turning on your computer.

This section contains the following topics:

- [The HP All-in-One at a glance](#)
- [Control panel overview](#)
- [Menu overview](#)
- [Text and symbols](#)
- [Use the HP Photosmart Software](#)

### The HP All-in-One at a glance

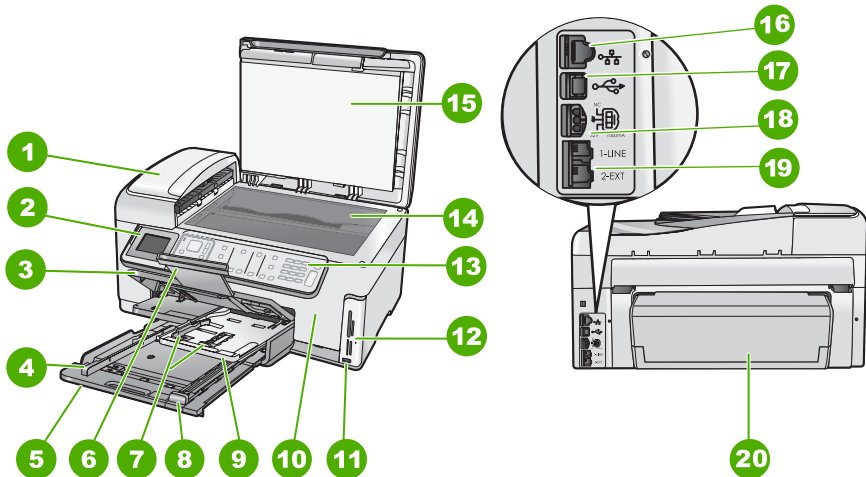

Label	Description
1	Automatic document feeder
2	Color graphics display (also referred to as the display)
3	Output tray
4	Paper-width guide for the main input tray
5	Main input tray (also referred to as the input tray)
6	Paper tray extender (also referred to as the tray extender)

(continued)

Label	Description
7	Paper-width and paper-length guides for the photo tray
8	Paper-length guide for the main input tray
9	Photo tray
10	Ink cartridge door
11	Front USB port for your camera or other storage device
12	Memory card slots and Photo light
13	Control panel
14	Glass
15	Lid backing
16	Ethernet port
17	Rear USB port
18	Power connection*
19	1-LINE (fax) and 2-EXT (phone) ports
20	Two-sided printing accessory

\* Use only with the power adapter supplied by HP.

## Control panel overview

This section describes the functions of the control panel buttons and lights, as well as the icons and sleep state on the display.

This section contains the following topics:

- [Control panel features](#)
- [Display icons](#)
- [Display sleep state](#)

## Control panel features

The following diagram and related table provide a quick reference to the HP All-in-One control panel features.

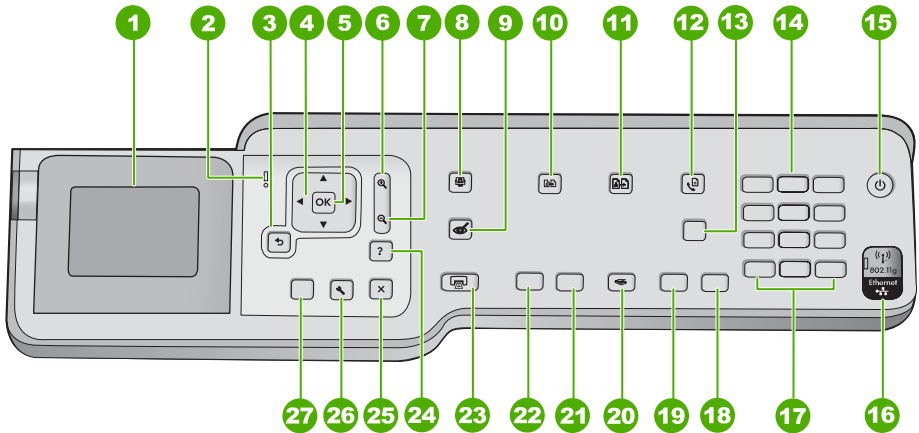

Label	Name and Description
1	<b>Display:</b> Displays menus, photos, and messages. The angle of the display can be changed for better viewing. Place a finger in the indented area to the left of the display and then pull up.
2	<b>Attention light:</b> Indicates a problem occurred. See the display for more information.
3	<b>Back:</b> Returns to the previous screen on the display.
4	<b>Directional pad:</b> Allows you to navigate through menu options by pressing the up, down, left, or right arrow buttons.  If you are zooming in on a photo, you can also use the arrow buttons to pan around the photo and select a different area to print.
5	<b>OK:</b> Selects a menu setting, value, or photo on the display.
6	<b>Zoom out -</b> (magnifying glass icon): Zooms out to show more of a photo. If you press this button when a photo is shown on the display at 100%, the <b>Fit to Page</b> feature is applied to the photo automatically.
7	<b>Zoom in +</b> (magnifying glass icon): Zooms in to enlarge the image on the display. You can also use this button together with the arrows on the directional pad to adjust the crop box for printing.
8	<b>Photo Menu:</b> Launches the <b>Photosmart Express</b> menu for printing, saving, editing, and sharing photos.
9	<b>Red Eye Removal:</b> Turns the <b>Red Eye Removal</b> feature On or Off. By default, this feature is turned off. When the feature is turned on, the HP All-in-One automatically corrects red eye coloring in the photo currently shown on the display.
10	<b>Copy Menu:</b> Opens the <b>Copy Menu</b> where you can select copy options, such as number of copies, paper size, and paper type.
11	<b>Reprints:</b> Enables you to make a copy of an original photo placed on the glass.







Label	Name and Description
12	<b>Fax Menu:</b> Presents the <b>Enter Fax Number</b> screen to enter a fax number. If you press it again, the <b>Fax Menu</b> appears where you can select fax options.
13	<b>Auto Answer:</b> When this button is lit, the HP All-in-One automatically answers incoming phone calls. When off, the HP All-in-One does not answer any incoming fax calls.
14	Keypad: Enters fax numbers, values, or text.
15	<b>On:</b> Turns the HP All-in-One on or off. When the HP All-in-One is off, a minimal amount of power is still supplied to the device. You can further reduce power supply by holding down the <b>On</b> button for 3 seconds. This places the HP All-in-One in Federal Energy Management Program (FEMP) mode. To completely remove power, turn the HP All-in-One off, and then unplug the power cord.
16	<b>Wireless radio light:</b> Indicates that the 802.11 b and g wireless radio is turned on.
17	<b>Space and #:</b> Enter spaces and pound signs for fax-related tasks. <b>Symbols and *:</b> Enter symbols and asterisks for fax-related tasks.
18	<b>Start Fax Color:</b> Starts a color fax.
19	<b>Start Fax Black:</b> Starts a black-and-white fax.
20	<b>Scan Menu:</b> Opens the <b>Scan Menu</b> where you can select a destination for your scan.
21	<b>Start Copy Color:</b> Starts a color copy.
22	<b>Start Copy Black:</b> Starts a black-and-white copy.
23	<b>Print Photos:</b> Depending on whether you access your photos from the <b>View</b> , <b>Print</b> , or <b>Create</b> menu, the <b>Print Photos</b> button will display the <b>Print Preview</b> screen or it will print any selected photo(s). If no photos are selected, a prompt appears asking if you want to print all the photos on your card or storage device.
24	<b>Cancel:</b> Stops the current operation.
25	<b>Setup:</b> Presents the <b>Setup Menu</b> for generating reports, changing fax and network settings, and accessing tools and preferences.
26	<b>Help:</b> Opens the <b>Help Menu</b> menu on the display where you can select a topic to learn more about it. Depending on the topic you select, the topic will appear on your display or on your computer screen.  From the idle state, pressing <b>Help</b> lists a menu of items for which the user can obtain help. When viewing screens other than Idle, the <b>Help</b> button provides context sensitive help.

## Display icons

The following icons can appear at the bottom of the display to provide important information about the HP All-in-One.

Icon	Purpose
	Shows the ink cartridge status. The color of the icon corresponds to the color of the ink cartridge, and the fill level of the icon corresponds to the fill level of the ink cartridge.

(continued)

Icon	Purpose
	<b>NOTE:</b> The ink level icons will only appear if one of the ink cartridges is less than 50% full. If the ink level for all ink cartridges is more than 50% full, the ink cartridge icons do not appear on the display.
	Shows that the ink cartridge is nearly empty, and will need to be replaced.
	Shows that an unknown ink cartridge is inserted. This icon might appear if an ink cartridge contains non-HP ink.
	Shows the wired network connection status.
	If the <b>Auto Answer</b> icon is showing on the display, the HP All-in-One will receive faxes automatically. If there is no icon showing, you will have to receive faxes manually.
	Indicates the presence and signal strength of a wireless network connection.
	Indicates the presence of an Ad hoc wireless network connection.
	Indicates that an HP bt450, Printer and PC Adapter with Bluetooth® Wireless Technology is connected to the front USB port.

## Display sleep state

To prolong the life of the display, it dims after two minutes of inactivity. After 30 minutes of inactivity, the display goes into a sleep state and the screen shuts off completely. The display turns back on when you press a control panel button, insert a memory card or connect a storage device, lift the lid, or access the HP All-in-One from a connected computer.

## Menu overview

The following topics provide a quick reference to top-level menus that appear on the HP All-in-One display.

- [Photosmart Express Menu](#)
- [Copy Menu](#)
- [Scan Menu](#)
- [Fax Menu](#)







- [Setup Menu](#)
- [Help Menu](#)

### Photosmart Express Menu

The following options are available in the **Photosmart Express** menu when you insert a memory card or storage device, or when you press **Photo Menu** on the control panel.



#### View

			
<b>Print</b>	<b>Create</b>	<b>Share</b>	<b>Save</b>

### Copy Menu

The following options are available when you press the **Copy Menu** button on the control panel.

- Copies**
- Size**
- Quality**
- Lighter/Darker**
- Preview**
- Crop**
- Paper Size**
- Paper Type**
- Margin Shift**
- Enhancements**
- Set As New Defaults**

## Scan Menu

The following options are available when you press the **Scan Menu** button on the control panel.

 **NOTE:** The applications that appear on the **Scan Menu** vary depending on the software applications installed on your computer.

**Scan and Reprint**  
**Scan to Memory Card**  
**HP Photosmart Premier**  
**Scan to Computer**

 **NOTE:** The **Scan to Computer** option only appears if the HP All-in-One is network-connected.

## Fax Menu

When you press the **Fax Menu** button, the **Enter Fax Number** screen appears where you can enter a fax number.

If you press the **Fax Menu** button again, the **Fax Menu** appears where you can change the following fax options.

**Resolution**  
**Lighter/Darker**  
**Scan and Fax**  
**Broadcast Fax**  
**Send Fax Later**  
**Poll to Receive**  
**Set As New Defaults**

## Setup Menu

The following options are available when you press the **Setup** button on the control panel.

**Printable School Papers**  
**Print Report**  
**Speed Dial Setup**  
**Basic Fax Setup**  
**Advanced Fax Setup**  
**Network**  
**Tools**  
**Preferences**  
**Bluetooth Menu**



**NOTE:** The **Bluetooth Menu** option only appears if an optional HP bt450, Printer and PC Adapter with Bluetooth® Wireless Technology is attached to the HP All-in-One.

## Help Menu

The **Help Menu** menu provides quick access to key help topics and is available when you press the **Help** button. If you select one of the first six topics, the help appears on the display. If you select one of the last six topics, the help appears on your computer. The following options are available.

**Use Control Panel**  
**Insert Ink Cartridges**  
**Load Paper in Photo Tray**  
**Load Paper**  
**Load Original on Scanner**  
**Icon Glossary**  
**How Do I**  
**Error Messages**  
**General Troubleshooting**  
**Networking Troubleshooting**  
**Use Memory Card**  
**Get Support**

## Text and symbols

You can enter text and symbols from the control panel by using the visual keyboard. It appears automatically on the display when setting up a wired or wireless network, the fax header information, or speed dial entries. You can also use the keypad on the control panel to enter text and symbols.

You can also enter symbols from the keypad when you dial a fax or phone number. When the HP All-in-One dials the number, it will interpret the symbol and respond accordingly. For example, if you enter a dash in the fax number, the HP All-in-One will pause before dialing the remainder of the number. A pause is useful if you need to access an outside line before dialing the fax number.



**NOTE:** If you want to enter a symbol in your fax number, such as a dash, you need to enter the symbol by using the keypad.

This section contains the following topics:

- [Enter text using the keypad on the control panel](#)
- [Enter text using the visual keyboard](#)
- [Available symbols for dialing fax numbers](#)

### Enter text using the keypad on the control panel

You can enter text or symbols by using the keypad on the control panel.

### To enter text

1. Press the keypad numbers that correspond to the letters of a name. For example, the letters a, b, and c correspond to the number 2, as shown on the button below.



---

 **TIP:** Press a button multiple times to see the available characters. Depending on your language and country/region setting, other characters might be available in addition to the ones shown on the keypad.

---

2. After the correct letter appears, wait for the cursor to advance automatically to the right, or press . Press the number that corresponds to the next letter in the name. Press the button multiple times until the correct letter appears. The first letter of a word is automatically set to uppercase.

### To enter a space, pause, or symbol

- ▲ To insert a space, press **Space**.

To enter a pause, press **Symbols** repeatedly until a dash appears.

To enter a symbol, such as @, press the **Symbols** button repeatedly to scroll through the list of available symbols: asterisk (\*), dash (-), ampersand (&), period (.), slash (/), parentheses ( ), apostrophe ('), equals (=), number sign (#), at (@), underscore (\_), plus (+), exclamation (!), semicolon (;), question (?), comma (,), colon (:), percent (%), and approximation (~).

### To erase a letter, number, or symbol

- ▲ If you make a mistake, press  to clear it, and then make the correct entry.

After you are done entering text, press **OK** to store your entry.

## Enter text using the visual keyboard

You can enter text or symbols by using the visual keyboard that automatically appears on the display when you need to enter text. For example, the visual keyboard automatically appears when you are setting up a wired or wireless network, the fax header information, or speed dial entries.

---

 **TIP:** You can also enter text and numbers using the visual keyboard by using the keypad on the control panel of the HP All-in-One. Press a button numerous times to access additional letters. For instance, press **2** three times to enter the letter **C**.

---

### To enter text using the visual keyboard

1. To select a letter, number, or symbol in the visual keyboard, press ◀, ▶, ▲, and ▼ to highlight the appropriate selection.

#### To enter lowercase letters, uppercase letters, numbers, and symbols

- To enter lowercase letters, select the **abc** button on the visual keyboard, and then press **OK**.
  - To enter uppercase letters, select the **ABC** button on the visual keyboard, and then press **OK**.
  - To enter numbers, select the **123** button on the visual keyboard, and then press **OK**.
  - To enter symbols, select the **.@!** button on the visual keyboard, and then press **OK**.
2. After you highlight the appropriate letter, number, or symbol, press **OK** on the control panel to select it.  
The selection appears on the display.

---

 **TIP:** To erase a letter, number, or symbol, select **Clear** on the visual keyboard, and then press **OK**.

---

3. When you are finished entering text, numbers, or symbols, select **Done** on the visual keyboard, and then press **OK**.

### Available symbols for dialing fax numbers

To enter a symbol, such as \*, press **Symbols** repeatedly to scroll through the list of symbols. The following table provides the symbols that you can use in a fax or phone number sequence, fax header information, and speed dial entries.

Available symbols	Description	Available when entering
*	Displays an asterisk symbol when required for dialing.	Fax header name, speed dial names, speed dial numbers, fax or phone numbers, and monitor dial entries
-	When auto-dialing, the HP All-in-One enters a pause in the number sequence.	Fax header name, fax header number, speed dial names, speed dial numbers, and fax or phone numbers
( )	Displays a left or right parenthesis to separate numbers, such as area codes, for easier reading. These symbols do not affect dialing.	Fax header name, fax header number, speed dial names, speed dial numbers, and fax or phone numbers
W	When auto-dialing, W causes the HP All-in-One to wait for a dial tone before continuing to dial.	Speed dial numbers and fax or phone numbers
R	During auto-dialing, the R functions the same as a Flash button on your telephone.	Speed dial numbers and fax or phone numbers

(continued)

Available symbols	Description	Available when entering
+	Displays a plus symbol. This symbol does not affect dialing.	Fax header name, fax header number, speed dial names, speed dial numbers, and fax or phone numbers

## Use the HP Photosmart Software

The HP Photosmart Software provides a fast and easy way to make prints of your photos. It also provides access to other basic HP imaging software features, such as saving and viewing your photos.





For more information on using the HP Photosmart Software:

- Check the **Contents** panel on the left. Look for the **HP Photosmart Software Help contents** book at the top.
- If you do not see the **HP Photosmart Software Help contents** book at the top of the **Contents** panel, access the software help through the HP Solution Center.

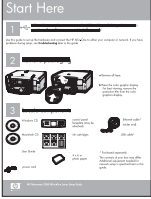

# 3 Find more information

You can access a variety of resources, both printed and onscreen, that provide information about setting up and using the HP All-in-One.

	<p><b>Setup Guide</b></p> <p>The Setup Guide provides instructions for setting up the HP All-in-One and installing software. Make sure you follow the steps in the Setup Guide in order. If you have problems during setup, check the Setup Guide for troubleshooting information, or see <a href="#">"Troubleshooting"</a> on page 169 in this onscreen Help.</p>
	<p><b>Basics Guide</b></p> <p>The Basics Guide contains an overview of the HP All-in-One, including step-by-step instructions for basic tasks, troubleshooting tips, and technical information.</p>
	<p><b>HP Photosmart Essential animations</b></p> <p>The HP Photosmart Essential animations are an interactive way to get a brief overview of the software included with the HP All-in-One. You will learn how the software can help you create, share, organize, and print your photos.</p>
	<p><b>Onscreen Help</b></p> <p>The onscreen Help provides detailed instructions on using all features of the HP All-in-One.</p> <ul style="list-style-type: none"><li>• The <b>How Do I?</b> topic provides links so you can quickly find information on performing common tasks.</li><li>• The <b>HP All-in-One overview</b> topic provides general information about the main features of the HP All-in-One.</li><li>• The <b>Troubleshooting</b> topic provides information about resolving errors you might encounter with the HP All-in-One.</li></ul>
	<p><b>Readme</b></p> <p>The Readme file contains the most recent information which might not be found in other publications.</p> <p>Install the software to access the Readme file.</p>
<p><a href="http://www.hp.com/support">www.hp.com/support</a></p>	<p>If you have Internet access, you can get help and support from the HP Web site. This Web site offers technical support, drivers, supplies, and ordering information.</p>





# 4 Finish setting up the HP All-in-One

After you have completed the steps in your Setup Guide, refer to this section to help you finish setting up the HP All-in-One. This section contains important setup-related information for your device, including information on setting preferences.

This section contains the following topics:

- [Set your preferences](#)
- [Computer connection information](#)
- [Connect to a network](#)
- [Fax setup](#)

## Set your preferences

You can change the settings on the HP All-in-One so that it behaves according to your preference. For example, you can set general device preferences, such as the language used to display messages and the date and time on the display. You can also restore the device settings to what they were when you purchased your device. This will erase any new defaults you have set.

This section contains the following topics:

- [General preferences](#)
- [Fax preferences](#)

### General preferences

Before you begin using the HP All-in-One, you should review and, if necessary, adjust the general device settings described in this section.

This section contains the following topics:

- [Set your language and country/region](#)
- [Set the date and time](#)
- [Adjust the volume](#)
- [Set the default paper tray for PictBridge/DPOF/uPnP printing](#)
- [Enable faster browsing of photos](#)
- [Set the paper tray for printing from a Bluetooth device](#)
- [Restore the factory defaults](#)
- [Play a slideshow on the display](#)

#### Set your language and country/region

The language setting determines which language the HP All-in-One uses to show messages on the display. The country/region setting determines the default paper sizes and layouts for printing. You can change these settings at any time by using the following procedure.

### To set your language and country/region

1. Press **Setup**.
2. Press ▼ to highlight **Preferences**, and then press **OK**.
3. Press ▼ to highlight **Set Language**, and then press **OK**.
4. Press ▼ to scroll through the languages. When the language you want to use appears, press **OK**.
5. When prompted, press ▼ to highlight **Yes** or **No**, and then press **OK**.
6. Press ▼ to highlight **Set Country/Region**, and then press **OK**.
7. Press ▼ to scroll through the countries/regions. When the country/region you want to use appears, press **OK**.
8. When prompted, press ▼ to highlight **Yes** or **No**, and then press **OK**.

### Set the date and time

You can set the date and time from the control panel. The date and time format is based on the language and country/region setting. When you send a fax, the current date and time are transmitted, along with your name and fax number, as part of the fax header.

---

 **NOTE:** In some countries/regions, the date and time stamp on the fax header is a legal requirement.

---

The HP All-in-One has a battery-powered clock so the date and time setting is not lost when the device is unplugged.

### To set the date and time

1. Press **Setup**.
2. Press ▼ to highlight **Tools**, and then press **OK**.
3. Press ▼ to highlight **Date and Time**, and then press **OK**.
4. Enter the month, day, and year by pressing the appropriate numbers on the keypad. Depending on your country/region setting, you might enter the date in a different order.
5. Enter the hours and minutes.
6. If your time is displayed in the 12-hour format, press **1** for AM, or **2** for PM. The new date and time settings appear on the display.

### Adjust the volume

You can adjust the volume of different aspects of the HP All-in-One, including the sounds associated with device events, errors, and fax tones.

### To adjust the volume sound effects

1. Press **Setup**.
2. Press ▼ to highlight **Preferences**, and then press **OK**.
3. Press ▼ to highlight **Sound Effects Volume**, and then press **OK**.
4. Press ▼ to highlight **Soft**, **Loud**, or **Off**, and then press **OK** to select the volume you want.

### To adjust the volume of fax sounds

1. Press **Setup**.
2. Press ▼ to highlight **Basic Fax Setup**, and then press **OK**.
3. Press ▼ to highlight **Fax Sound Volume**, and then press **OK**.
4. Press ▼ to highlight one of the options: **Soft**, **Loud**, or **Off**, and then press **OK**.

---

 **NOTE:** If you select **Off**, you will not hear a dial tone, fax tones, or incoming ring tones. With the **Fax Sound Volume** set to **Off**, you cannot send a fax using monitor dialing, such as when using a calling card to send a fax.

---

### Related topics

[“Send a fax using monitor dialing” on page 134](#)

### Set the default paper tray for PictBridge/DPOF/uPnP printing

Set the default paper tray to use when you print photos from a Pictbridge device, DPOF file, or a UPnP device. The default setting is **Photo Tray**.

#### To set the default paper tray

1. Press **Setup**.
2. Press ▼ to highlight **Preferences**, and then press **OK**.
3. Press ▼ to highlight **PictBridge/DPOF/uPnP Tray Select**, and then press **OK**.
4. Press ▼ or ▲ to highlight **Main Tray** or **Photo Tray**, and then press **OK** to select the tray you want.

### Enable faster browsing of photos

You can set up the HP All-in-One to enable faster photo browsing by writing small thumbnails to the memory card. The thumbnails take up a relatively small amount of space and are used to speed up the browsing performance of photos on the card.

---

 **NOTE:** This feature is on by default.

---

#### To turn faster browsing on or off

1. Press **Setup**.
2. Press ▼ to highlight **Preferences**, and then press **OK**.
3. Press ▼ to highlight **Enable Faster Photo Browsing**, and then press **OK**.
4. Press ▼ or ▲ to highlight **On** or **Off**, and then press **OK**.

### Set the paper tray for printing from a Bluetooth device

Set the default paper tray to use when you print photos from a Bluetooth device.

#### To set the paper tray for printing from a Bluetooth device

1. Press **Setup**.
2. Press ▼ to highlight **Bluetooth**, and then press **OK**.

3. Press ▼ to highlight **Bluetooth Tray Select**, and then press **OK**.
4. Press ▼ to highlight **Main Tray** or **Photo Tray**, and then press **OK**.

### Restore the factory defaults

You can restore the current settings to what they were when you purchased the HP All-in-One.

---

 **NOTE:** Restoring the factory defaults will not affect any changes you made to scan settings and the language and country/region settings.

---

You can perform this process from the control panel only.

---

 **NOTE:** Restoring the factory defaults does not erase any information you entered, such as the date and time and the fax header. It also does not delete any information saved to memory, such as the fax log and caller ID history.

---

### To restore the factory defaults

1. Press **Setup**.
2. Press ▼ to highlight **Tools**, and then press **OK**.
3. Press ▼ to highlight **Restore Factory Defaults**, and then press **OK**.  
The factory default settings are restored.

### Play a slideshow on the display

You can set up the HP All-in-One to play a slideshow on the display, similar to a screensaver on a computer, when you are not using the device.

There are two types of slideshows that you can enable:

- **Store Demo:** appears after the HP All-in-One is inactive for one minute and shows a set of predefined graphics that describe features of the device. The slideshow plays until you press a button or use the device. If the HP All-in-One remains inactive for eight hours, the display turns off.

---

 **NOTE:** HP recommends leaving **Store Demo** off.

---

- **Tips Slideshow:** appears only after you print from the computer. The HP All-in-One shows a set of predefined slides with information about special features that you can do with the device. The slideshow plays through once and then the display returns to the main menu.

### To turn the store demo on or off

1. Press **Setup**.
2. Press ▼ to highlight **Tools**, and then press **OK**.
3. Press ▼ to highlight **Store Demo**, and then press **OK**.
4. Press ▼ or ▲ to highlight **On** or **Off**, and then press **OK**.

### To turn the tips demo on or off

1. Press **Setup**.
2. Press ▼ to highlight **Tools**, and then press **OK**.

3. Press ▼ to highlight **Tips Slideshow**, and then press **OK**.
4. Press ▼ or ▲ to highlight **On** or **Off**, and then press **OK**.

## Fax preferences

You should review the information in the **Fax setup** section of the printed documentation to find out the recommended settings for the options described in the following topics. The recommended settings depend on how you set up the HP All-in-One for faxing with the other equipment and services that you might have on the same phone line as the HP All-in-One.

---

 **NOTE:** Before setting the fax preferences described in this section, make sure you have set the language/country/region and date/time preferences.

---

This section contains the following topics:

- [Set up the HP All-in-One to redial a fax number automatically](#)
- [Set tone or pulse dialing](#)
- [Set the fax speed](#)

### Related topics

- [“Fax setup” on page 61](#)
- [“General preferences” on page 25](#)

### Set up the HP All-in-One to redial a fax number automatically

You can set the HP All-in-One to redial a busy or an unanswered number automatically. The default **Busy Redial** setting is **Redial**. The default **No Answer Redial** setting is **No Redial**.

#### To set redial options from the control panel

1. Press **Setup**.
2. Do one of the following:

##### To change the Busy Redial setting

- a. Press ▼ to highlight **Advanced Fax Setup**, and then press **OK**.
- b. Press ▼ to highlight **Busy Redial**, and then press **OK**.

##### To change the No Answer Redial setting

- a. Press ▼ to highlight **Advanced Fax Setup**, and then press **OK**.
  - b. Press ▼ to highlight **No Answer Redial**, and then press **OK**.
3. Press ▼ to highlight **Redial** or **No Redial**, and then press **OK**.

### Set tone or pulse dialing

You can set the dial mode for the HP All-in-One to either tone dialing or pulse dialing. Most telephone systems work with either type of dialing. If your telephone system does not require pulse dialing, HP recommends using tone dialing. If you have a public telephone system or a private branch exchange (PBX) system, you might need to select

**Pulse Dialing.** Contact your local telephone company if you are unsure which setting to use.

 **NOTE:** If you select **Pulse Dialing**, some phone system features might not be available. It can also take longer to dial a fax or phone number.

**NOTE:** This feature is not supported in all countries/regions. If it is not supported in your country/region, **Tone or Pulse Dialing** does not appear in the **Basic Fax Setup** menu.

#### To set tone or pulse dialing from the control panel

1. Press **Setup**.
2. Press ▼ to highlight **Basic Fax Setup**, and then press **OK**.
3. Press ▼ to highlight **Tone or Pulse Dialing**, and then press **OK**.
4. Press ▼ to select **Tone Dialing** or **Pulse Dialing**, and then press **OK**.

#### Set the fax speed

You can set the fax speed used to communicate between the HP All-in-One and other fax machines when sending and receiving faxes. The default fax speed varies by country/region.

If you use one of the following, setting the fax speed to a slower speed might be required:

- An Internet phone service
- A PBX system
- Fax over Internet Protocol (FoIP)
- An integrated services digital network (ISDN) service

If you experience problems sending and receiving faxes, you might want to try setting the **Fax Speed** setting to **Medium (14400)** or **Slow (9600)**.

#### To set the fax speed from the control panel

1. Press **Setup**.
2. Press ▼ to highlight **Advanced Fax Setup**, and then press **OK**.
3. Press ▼ to highlight **Fax Speed**, and then press **OK**.
4. Press ▼ to select one of the following settings, and then press **OK**.

Fax speed setting	Fax speed
<b>Fast (33600)</b>	v.34 (33600 baud)
<b>Medium (14400)</b>	v.17 (14400 baud)
<b>Slow (9600)</b>	v.29 (9600 baud)

## Computer connection information

The HP All-in-One comes equipped with a USB port so you can connect directly to a computer using a USB cable. You can also connect the HP All-in-One to either a wired or wireless network. If you insert an HP bt450, Printer and PC Adapter with Bluetooth®

Wireless Technology into the front USB port, Bluetooth® devices such as PDAs and camera phones can print to the HP All-in-One.

 **NOTE:** In the remainder of this chapter, the HP bt450, Printer and PC Adapter with Bluetooth® Wireless Technology is referred to simply as an HP bt450.

This section contains the following topics:

- [Supported connection types](#)
- [Connect using Ethernet](#)
- [Connect using integrated wireless WLAN 802.11](#)
- [Connect using the HP bt450, Printer and PC Adapter with Bluetooth® Wireless Technology](#)
- [Use printer sharing](#)

## Supported connection types

Description	Recommended number of connected computers for best performance	Supported software features	Setup instructions
USB connection	One computer connected with a USB cable to the rear USB 2.0 High Speed port on the HP All-in-One.	All features are supported, except Webscan.	Follow the Setup Guide for detailed instructions.
Ethernet (wired) connection	Up to five computers connected to an HP All-in-One using a hub or router.	All features are supported, including Webscan.	Follow the instructions in <a href="#">“Wired network setup” on page 37</a> .
Wireless WLAN 802.11 connection	Up to five computers connected using a wireless router (infrastructure mode).	All features are supported, including Webscan.	Follow instructions in <a href="#">“Integrated wireless WLAN 802.11 network setup” on page 39</a> .
HP bt450, Printer and PC Adapter with Bluetooth® Wireless Technology	One Bluetooth device or computer.	Printing from a Bluetooth device such as a PDA or camera phone, or a Bluetooth-enabled computer.	Follow the instructions in <a href="#">“Connect using the HP bt450, Printer and PC Adapter with Bluetooth® Wireless Technology” on page 32</a> .
Printer sharing	Five. The host computer must be turned on at all times, or the other computers will not be able to print to the HP All-in-One.	All features resident on the host computer are supported. Only print is supported from the other computers.	Follow the instructions in <a href="#">“Use printer sharing” on page 36</a> .

## Connect using Ethernet

The HP All-in-One supports both 10 Mbps and 100 Mbps Ethernet network connections. For detailed instructions on connecting the HP All-in-One to an Ethernet (wired) network, see [“Wired network setup” on page 37](#).



## Connect using integrated wireless WLAN 802.11

The HP All-in-One uses an internal networking component that supports a wireless network. For detailed instructions on connecting the HP All-in-One to a wireless (802.11) network, see "[Integrated wireless WLAN 802.11 network setup](#)" on page 39.

## Connect using the HP bt450, Printer and PC Adapter with Bluetooth® Wireless Technology

HP bt450, Printer and PC Adapter with Bluetooth® Wireless Technology allows you to print images from most Bluetooth devices, including computers. Simply insert the HP bt450 into the front USB port and print from a Bluetooth device such as a PDA or camera phone.

This section contains the following topics:

- [Find the device name and address](#)
- [Set Bluetooth security for the HP All-in-One](#)
- [Use a Bluetooth® connection to print from your computer](#)

### Find the device name and address

Some Bluetooth devices exchange device addresses when they communicate with each other, so you might need to find out the device address of the HP All-in-One in order to establish a connection. Also, some Bluetooth devices display the name of the printer when connected. If you do not want the default name displayed as the name of the HP All-in-One, you can change the device name.

#### To find out the device address of the HP All-in-One

1. Insert the HP bt450 into the front USB port.
2. On the control panel of the HP All-in-One, press **Setup**.
3. Press ▼ until **Bluetooth** is highlighted, and then press **OK**.
4. Press ▼ until **Device Address** is highlighted, and then press **OK**.  
The **Device Address** appears, which is read only.
5. To enter the address into your device, follow the instructions that came with your Bluetooth device.
6. Press **OK** to exit the **Setup** menu.

#### To change the device name of the HP All-in-One

1. On the control panel of the HP All-in-One, press **Setup**.
2. Press ▼ until **Bluetooth** is highlighted, and then press **OK**.
3. Press ▼ until **Device Name** is highlighted, and then press **OK**.



**NOTE:** The HP All-in-One ships with the predefined name of **Photosmart C7200**.

---

4. Use the keypad to enter a new name.

5. When you have finished entering a name for the HP All-in-One, press **OK**.  
The name you entered will appear on your Bluetooth device when you connect to the HP All-in-One to print.
6. Press **OK** to exit the **Setup** menu.

### Related topics

[“Text and symbols” on page 18](#)

### Set Bluetooth security for the HP All-in-One

You can enable printer security settings through the **Bluetooth** menu on the HP All-in-One. Press **Setup** on the control panel, and select **Bluetooth**. From the **Bluetooth** menu, you can:

- Require passkey authentication prior to someone printing to the HP All-in-One from a Bluetooth device.
- Make the HP All-in-One visible or invisible to Bluetooth devices that are within range.

This section contains the following topics:

- [Use a passkey to authenticate Bluetooth devices](#)
- [Set the HP All-in-One to be invisible to Bluetooth devices](#)
- [Reset Bluetooth settings on the HP All-in-One](#)

### Use a passkey to authenticate Bluetooth devices

You can set the security level of the HP All-in-One to either **Low** or **High**. The default security setting is **Low**. Low level security does not require authentication.

- **Low**: This is the default security setting. Low level security does not require a passkey, as it does not support authentication. Any Bluetooth device within range can print to it.
- **High**: High level security requires a passkey, as it supports authentication. The Bluetooth device must provide a passkey, before the HP All-in-One will allow the device to send a print job to it.

---

 **NOTE:** The HP All-in-One ships with a predefined passkey that is set to four zeroes "0000".

---

### To set the HP All-in-One to require passkey authentication

1. On the control panel of the HP All-in-One, press **Setup**.
2. Press ▼ until **Bluetooth** is highlighted, and then press **OK**.
3. Press ▼ until **Passkey** is highlighted, and then press **OK**.
4. Use the keypad to enter a new passkey.

---

 **NOTE:** The passkey must be 1 to 4 characters long, and can only consist of numbers.

---

5. When you have finished entering your passkey, press **OK**.  
The **Bluetooth** menu appears.

6. Press ▼ until **Security Level** is highlighted, and then press **OK**.
7. Press **OK** to select **High**.  
High level security requires authentication.  
Passkey authentication is now set for the HP All-in-One.

### Related topics

[“Text and symbols” on page 18](#)

### Set the HP All-in-One to be invisible to Bluetooth devices

You can set the HP All-in-One to be either **Visible to all** Bluetooth devices (public) or **Not visible** to any (private).

- **Visible to all:** Any Bluetooth device within range can print to the HP All-in-One.
- **Not visible:** Only Bluetooth devices that have stored the device address of the HP All-in-One can print to it.

---

 **NOTE:** The HP All-in-One ships with a default accessibility level of **Visible to all**.

---

### To set the HP All-in-One to be Not visible

1. On the control panel of the HP All-in-One, press **Setup**.
2. Press ▼ until **Bluetooth** is highlighted, and then press **OK**.
3. Press ▼ until **Visibility** is highlighted, and then press **OK**.
4. Press ▼ to select **Not visible**, and then press **OK**.  
The HP All-in-One is inaccessible to Bluetooth devices that have not stored its device address.

### Reset Bluetooth settings on the HP All-in-One

You can reset all of the Bluetooth settings on the HP All-in-One to the factory defaults.

---

 **NOTE:** Only select **Reset Bluetooth** if you want all of the HP All-in-One Bluetooth settings returned to factory defaults.

---

### To reset the Bluetooth settings

1. On the control panel of the HP All-in-One, press **Setup**.
2. Press ▼ until **Bluetooth** is highlighted, then press **OK**.
3. Press ▼ until **Reset Bluetooth** is highlighted, then press **OK**.

### Use a Bluetooth® connection to print from your computer

A Bluetooth connection provides a quick and easy way to print images from a Bluetooth-enabled computer without using a cable. With a Bluetooth connection you can access many of the same printing features as with a USB connection. For example, you can check the printer status, as well as the estimated amount of ink remaining in your ink cartridges.

---

 **NOTE:** The only software functionality available with a Bluetooth connection is printing. Scanning and software-based faxing cannot be done over a Bluetooth connection. However, stand-alone copy and fax functions are still available.

---

Before you print, you must connect an HP bt450, Printer and PC Adapter with Bluetooth® Wireless Technology to the HP All-in-One.

You must have Windows XP or Windows Vista and either the Microsoft Bluetooth® Protocol Stack or the Widcomm Bluetooth® Protocol Stack installed in order to connect the HP All-in-One. It is possible to have both the Microsoft Stack and the Widcomm Stack on your computer, but you use only one of them to connect the HP All-in-One.

- **Microsoft stack** If you have Windows XP with Service Pack 2 or Windows Vista installed on your computer, then your computer has the Microsoft Bluetooth® Protocol Stack. The Microsoft stack allows you to install an external Bluetooth® adapter automatically. If your Bluetooth® adapter supports the Microsoft stack but it does not install automatically, then you do not have the Microsoft stack on your computer. Check the documentation that came with the Bluetooth® adapter to see if it supports the Microsoft stack.
- **Widcomm stack:** If you have an HP computer with Bluetooth® built in, or if you have installed an HP bt450, then your computer has the Widcomm stack. If you have an HP computer and plug in an HP bt450, it will install automatically using the Widcomm stack.

### To install and print using the Microsoft stack

1. Make sure that you have installed the HP All-in-One software on the computer.

 **NOTE:** The purpose of installing the software is to make sure the printer driver is available for the Bluetooth® connection. Therefore, if you have already installed the software, you do not need to reinstall it. If you want both a USB and a Bluetooth® connection to the HP All-in-One, install the USB connection first. For more information, see the Setup Guide. However, if you do not want a USB connection, select **Directly to the computer** on the **Connection Type** screen. Also, on the **Connect Your Device Now** screen, select the check box next to **If you are unable to connect your device now...** at the bottom of the screen.

---

2. Attach an HP bt450 to the front USB port of the HP All-in-One.
3. If you are using an external Bluetooth® adapter for your computer, make sure your computer is started and then attach the Bluetooth® adapter to a USB port on the computer. If you have Windows XP with Service Pack 2 or Windows Vista installed, the Bluetooth® drivers are installed automatically. If you are prompted to select a Bluetooth® profile, select **HCRP**.  
If your computer has Bluetooth® built in, just make sure the computer is started.
4. On the Windows taskbar, click **Start**, and then click **Printers and Faxes** (or click **Control Panel**, and then **Printers**).
5. Double-click the **Add Printer** icon (or click **Add a printer**).
6. Click **Next**, and then select **A Bluetooth Printer**.
7. Follow the onscreen instructions to finish the installation.
8. Print as you would to any printer.

### To install and print using the Widcomm stack

1. Make sure that you have installed the HP All-in-One software on the computer.

 **NOTE:** The purpose of installing the software is to make sure the printer driver is available for the Bluetooth® connection. Therefore, if you have already installed the software, you do not need to reinstall it. If you want both a USB and a Bluetooth® connection to the HP All-in-One, install the USB connection first. For more information, see the Setup Guide. However, if you do not want a USB connection, select **Directly to the computer** on the **Connection Type** screen. Also, on the **Connect Your Device Now** screen, select the check box next to **If you are unable to connect your device now...** at the bottom of the screen.

2. Attach an HP bt450 to the front USB port of the HP All-in-One.
3. Click the **My Bluetooth Places** icon on the desktop or in the taskbar.
4. Click **View devices in range**.
5. Once the available printers are discovered, double-click the name of HP All-in-One to finish the installation.
6. Print as you would to any printer.

### Use printer sharing

If your computer is on a network, and another computer on the network has an HP All-in-One connected to it by a USB cable, you can print to that printer using printer sharing.

The computer directly connected to the HP All-in-One acts as the **host** for the printer and has full software functionality. The other computer, which is referred to as a **client**, has access only to the print features. You must perform other functions from the host computer or from the control panel on the HP All-in-One.

#### To enable printer sharing on a Windows computer

- ▲ Refer to the user guide that came with your computer or see the Windows onscreen Help.

## Connect to a network

This section describes how to connect the HP All-in-One to a network and how to view and manage network settings.

If you want to:	See this section:
Connect to a wired (Ethernet) network.	<a href="#">“Wired network setup” on page 37</a>
Connect to a wireless network with a wireless router (infrastructure).	<a href="#">“Integrated wireless WLAN 802.11 network setup” on page 39</a>
Connect directly to a wireless-capable computer without a wireless router (ad hoc).	<a href="#">“Wireless ad hoc network setup” on page 43</a>
Install the HP All-in-One software for use in a networked environment.	<a href="#">“Install the software for a network connection” on page 46</a>
Add connections to more computers on the network.	<a href="#">“Connect to additional computers on a network” on page 47</a>

(continued)

If you want to:	See this section:
Change the HP All-in-One from a USB connection to a network connection.  <b>NOTE:</b> Use the instructions in this section if you first installed the HP All-in-One with a USB connection, and you now want to change to either a wireless or Ethernet network connection.	<a href="#">“Change the HP All-in-One from a USB connection to a network connection”</a> on page 47
View or change the network settings.	<a href="#">“Manage your network settings”</a> on page 48
Find troubleshooting information.	<a href="#">“Network troubleshooting”</a> on page 183

 **NOTE:** You can connect the HP All-in-One to either a wireless or wired network, but not both at the same time.

## Wired network setup

This section describes how to connect the HP All-in-One to a router, switch, or hub using an Ethernet cable and how to install the HP All-in-One software for a network connection. This is known as a wired or Ethernet network.

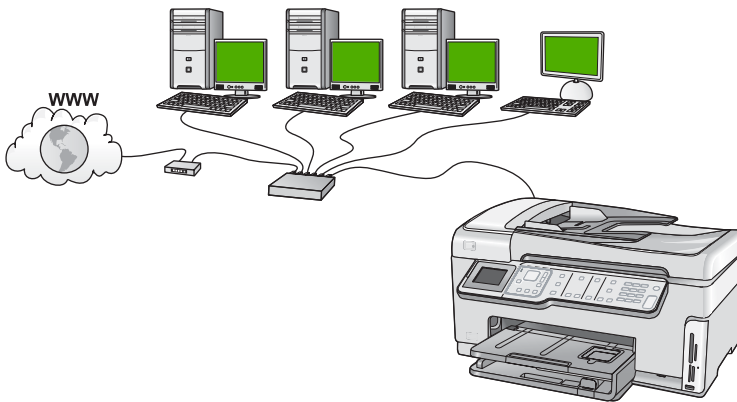

To set up the HP All-in-One on a wired network, you need to do the following:	See this section:
First, collect all of the required materials.	<a href="#">“What you need for a wired network”</a> on page 38
Next, connect to a wired network.	<a href="#">“Connect the HP All-in-One to the network”</a> on page 38
Finally, install the software.	<a href="#">“Install the software for a network connection”</a> on page 46

### What you need for a wired network

Before you connect the HP All-in-One to a network, make sure you have all of the required materials.

- ❑ A functional Ethernet network that includes a router, switch, or hub with an Ethernet port.
- ❑ CAT-5 Ethernet cable.

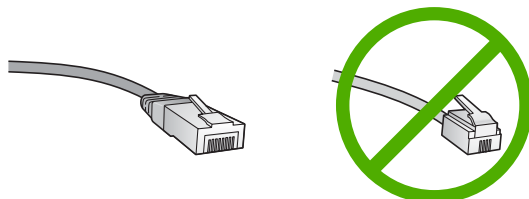

Although standard Ethernet cables look similar to standard telephone cables, they are not interchangeable. There is a different number of wires in each one, and each has a different connector. An Ethernet cable connector (also called an RJ-45 connector) is wider and thicker and always has 8 contacts on the end. A phone connector has between 2 and 6 contacts.

- ❑ A desktop computer or laptop with an Ethernet connection.



**NOTE:** The HP All-in-One supports both 10 Mbps and 100 Mbps Ethernet networks. If you are purchasing, or have purchased, a network interface card (NIC), make sure it can operate at either speed.

### Connect the HP All-in-One to the network

An Ethernet port is provided on the back of the HP All-in-One.

#### To connect the HP All-in-One to the network

1. Remove the yellow plug from the back of the HP All-in-One.

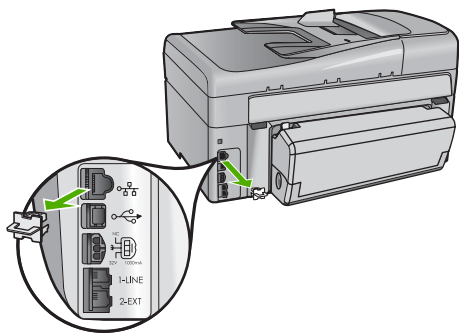

2. Connect the Ethernet cable to the Ethernet port on the back of the HP All-in-One.

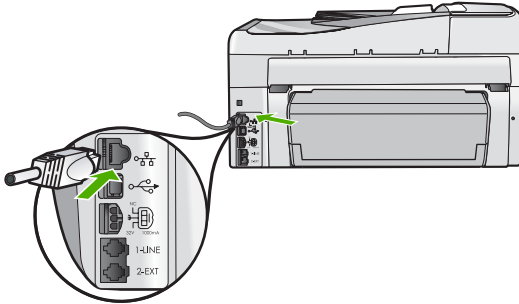

3. Connect the other end of the Ethernet cable to an available port on your Ethernet router or switch.

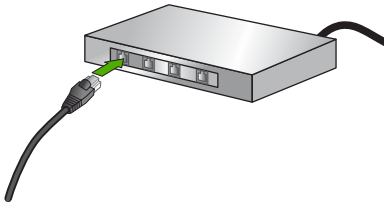

4. Once you have connected the HP All-in-One to the network, install the software.

### Related topics

[“Install the software for a network connection” on page 46](#)

## Integrated wireless WLAN 802.11 network setup

For optimal performance and security in your wireless network, HP recommends you use a wireless router or access point (802.11) to connect the HP All-in-One and the other network elements. When network elements are connected through a wireless router or access point, this is called an **infrastructure** network.

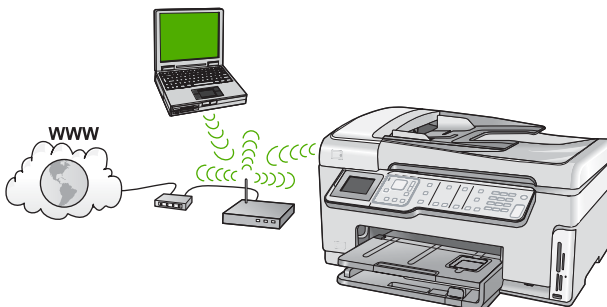



The advantages of a wireless infrastructure network as compared to an ad hoc network include:

- Advanced network security
- Enhanced reliability
- Network flexibility
- Better performance, especially with 802.11 g mode
- Shared Broadband Internet access

<b>To set up the HP All-in-One on an integrated wireless WLAN 802.11 network, you need to do the following:</b>	<b>See this section:</b>
First, collect all of the required materials.	<a href="#">“What you need for an integrated wireless WLAN 802.11 network”</a> on page 40
Next, connect the HP All-in-One to the wireless router, and run the Wireless Setup Wizard.	<a href="#">“Connect to an integrated wireless WLAN 802.11 network”</a> on page 40
Finally, install the software.	<a href="#">“Install the software for a network connection”</a> on page 46

### What you need for an integrated wireless WLAN 802.11 network

To connect the HP All-in-One to an integrated wireless WLAN 802.11 network, you will need the following:

- A wireless 802.11 network that includes a wireless router or access point.
- A desktop computer or laptop with either wireless networking support, or a network interface card (NIC). The computer must be connected to the wireless network that you intend to install the HP All-in-One on.
- Broadband Internet access (recommended) such as cable or DSL.  
If you connect the HP All-in-One on a wireless network that has Internet access, HP recommends that you use a wireless router (access point or base station) that uses Dynamic Host Configuration Protocol (DHCP).
- Network name (SSID).
- WEP key or WPA Passphrase (if needed).

### Connect to an integrated wireless WLAN 802.11 network

The Wireless Setup Wizard provides an easy way to connect the HP All-in-One to your network. You can also use SecureEasySetup, if your wireless router or access point

supports this feature. See the documentation that came with your wireless router or access point to find out if it supports using EasySetup and for additional setup instructions.

**CAUTION:** To prevent other users from accessing your wireless network, HP strongly recommends using a password or passphrase (WPA or WEP security) and a unique network name (SSID) for your wireless router. Your wireless router might have been shipped with a default network name, which is typically the manufacturer name. If you use the default network name, your network can be easily accessed by other users using the same default network name (SSID). It also means that the HP All-in-One might accidentally connect to a different wireless network in your area which uses the same network name. If this happens you will not be able to access the HP All-in-One. For more information on how to change the network name, see the documentation that came with your wireless router.

**NOTE:** Before connecting to a wireless infrastructure network, ensure that the ethernet cable is not connected to the HP All-in-One.

### To connect the HP All-in-One with the Wireless Setup Wizard

1. Write down the following information about your wireless router or access point:

- Network Name (also called SSID)
- WEP Key, WPA Passphrase (if needed)

If you do not know where to find this information, see the documentation that came with your wireless router or access point. You might be able to find the network name (SSID) and the WEP key or WPA passphrase on the Embedded Web Server for the wireless router or access point.

2. On the control panel of the HP All-in-One, press **Setup**.

3. Press **▼** until **Network** is highlighted, and then press **OK**.

4. Press **▼** to highlight **Wireless Setup Wizard**, and then press **OK**.

This runs the **Wireless Setup Wizard**. The setup wizard searches for available networks, and then displays a list of detected network names (SSIDs). The networks with the strongest signal appear first, the weakest appear last.

The wireless network test also runs, performing a series of diagnostic tests to determine whether network setup is successful. The wireless network test prints upon completion of the test.

5. Press **▼** to highlight the name of the network you wrote down in step 1, and then press **OK**.

#### If you do not see your network name in the list

a. Select **Enter a New Network Name (SSID)**. If necessary, use the **▼** to highlight it, and then press **OK**.

The visual keyboard appears.

b. Enter the SSID. Use the arrow buttons on the HP All-in-One control panel to highlight a letter or number on the visual keyboard, and then press **OK** to select it.

**NOTE:** You must enter the **exact** uppercase (capital) and lowercase (small) letters. Otherwise, the wireless connection will fail.

- c. When you have finished entering the new SSID, use the arrow buttons to highlight **Done** on the visual keyboard, and then press **OK**.

---

 **TIP:** If the HP All-in-One is unable to discover the network based on the network name you entered, you will see the following prompts. You may want to move the HP All-in-One closer to the computer and try running the Wireless Setup Wizard again to automatically discover the network.

---

- d. Press ▼ until **Infrastructure** is highlighted, and then press **OK**.  
 e. Press ▼ until **WEP encryption** or **WPA encryption** is highlighted, and then press **OK**.

If you do **not** want to use WEP encryption, press ▼ until **No, my network does not use encryption** is highlighted, and then press **OK**. Go to step 7.

6. If prompted, enter your WPA or WEP key as follows:  
 a. Use the arrow buttons to highlight a letter or number on the visual keyboard, and then press **OK** to select it.

---

 **NOTE:** You must enter the **exact** uppercase (capital) and lowercase (small) letters. Otherwise, the wireless connection will fail.

---

- b. When you are finished entering the WPA or WEP key, use the arrow buttons to highlight **Done** on the visual keyboard.  
 c. Press **OK** to confirm.

The HP All-in-One will attempt to connect to the network. If a message says you entered an invalid WPA or WEP key, check the key you wrote down for your new network, follow the prompts to correct the key, and then try again.

7. When the HP All-in-One connects successfully to the network, install the software on each computer that will use the device over the network.

### To connect the HP All-in-One with SecureEasySetup

1. Activate SecureEasySetup on your wireless router or access point.
2. On the control panel of the HP All-in-One, press **Setup**.
3. Press ▼ until **Network** is highlighted, and then press **OK**.
4. Press ▼ to highlight **Wireless Setup Wizard**, and then press **OK**.
5. Follow the onscreen prompts on the display to complete the connection.
6. When the HP All-in-One connects successfully to the network, go to your computer to install the software on each computer that will use the network.

---

 **NOTE:** If the connection fails, the wireless router or access point might have timed out after you activated SecureEasySetup. Repeat the above task, ensuring that you complete the steps on the control panel of the HP All-in-One immediately after pressing the button on the wireless router or access point.

---

### Related topics

- [“Enter text using the visual keyboard” on page 19](#)
- [“Install the software for a network connection” on page 46](#)
- [“Network troubleshooting” on page 183](#)

## Wireless ad hoc network setup

Use this section if you want to connect the HP All-in-One to a wireless-capable computer without using a wireless router or access point.

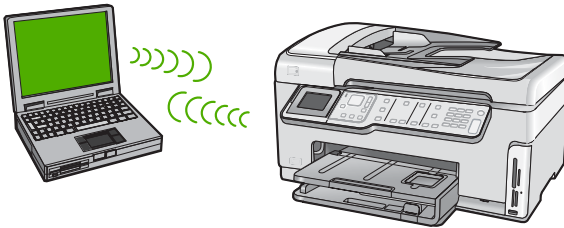

**NOTE:** An ad hoc connection is available if you do not have a wireless router or access point. However, it provides little flexibility, a low level of network security, and slower network performance than with a wireless router or access point.

In order to connect the HP All-in-One to your computer (ad hoc), you need to create an ad hoc network profile on your computer. This includes choosing a network name (SSID) and WEP security (optional but recommended) for your ad hoc network.

To set up the HP All-in-One on a wireless ad hoc network, you need to do the following:	See this section:
First, collect all of the required materials.	<a href="#">"What you need for an ad hoc network" on page 43</a>
Next, prepare your computer by creating a network profile.	<a href="#">"Create a network profile for a Windows XP computer" on page 43</a> <a href="#">"Create a network profile for other operating systems" on page 45</a>
Next, run the Wireless Setup Wizard.	<a href="#">"Connect to a wireless ad hoc network" on page 45</a>
Finally, install the software.	<a href="#">"Install the software for a network connection" on page 46</a>

### What you need for an ad hoc network

To connect the HP All-in-One to a wireless network, you will need a Windows computer with a wireless network adapter.

### Create a network profile for a Windows XP computer

Prepare your computer for an ad hoc connection by creating a network profile.

#### To create a network profile

**NOTE:** The HP All-in-One comes configured with a network profile with **hpsetup** as the network name (SSID). However, for security and privacy HP recommends you create a new network profile on your computer as described here.

1. In the **Control Panel**, double-click **Network Connections**.
2. On the **Network Connections** window, right-click the **Wireless Network Connection**. If you see **Enable** on the pop-up menu, select it. Otherwise, if you see **Disable** on the menu, the wireless connection is already enabled.
3. Right-click the **Wireless Network Connection** icon, and then click **Properties**.
4. Click the **Wireless Networks** tab.
5. Select the **Use Windows to configure my wireless network settings** check box.
6. Click **Add**, and then do the following:
  - a. In **Network name (SSID)** box, type in a unique network name of your choice.

---

 **NOTE:** The network name is case sensitive, so it is important to remember any uppercase (capital) and lowercase (small) letters.

---

- b. If there is a **Network Authentication** list, select **Open**. Otherwise, go to the next step.
- c. In the **Data encryption** list, select **WEP**.

---

 **NOTE:** It is possible to create a network that does not use a WEP key. However, HP recommends using a WEP key in order to secure your network.

---

- d. Make sure that the check box is **not** selected next to **The key is provided for me automatically**. If it is selected, click the check box to clear it.
- e. In the **Network key** box, type a WEP key that has **exactly 5** or **exactly 13** alphanumeric (ASCII) characters. For example, if you enter 5 characters, you might enter **ABCDE** or **12345**. Or, if you enter 13 characters, you might enter **ABCDEF1234567**. (12345 and ABCDE are examples only. Select a combination of your choosing.)  
Alternatively, you can use HEX (hexadecimal) characters for the WEP key. A HEX WEP key must be 10 characters for 40 bit encryption, or 26 characters for 128 bit encryption.
- f. In the **Confirm network key** box, type the same WEP key you typed in the previous step.
- g. Write down the WEP key exactly as you typed it, including uppercase and lowercase letters.

---

 **NOTE:** You must remember the exact uppercase (capital) and lowercase (small) letters. If you enter your WEP key incorrectly on the HP All-in-One, the wireless connection will fail.

---

- h. Select the check box for **This is a computer-to-computer (ad hoc) network; wireless access points are not used**.
- i. Click **OK** to close the **Wireless network properties** window, and then click **OK** again.
- j. Click **OK** again to close the **Wireless Network Properties Connection** window.

#### Related topics

- [“Network glossary” on page 59](#)
- [“Connect to a wireless ad hoc network” on page 45](#)

## Create a network profile for other operating systems

If you have an operating system other than Windows XP, HP recommends that you use the configuration program that came with your wireless LAN card. To find the configuration program for your wireless LAN card, access your computer's list of programs.

Using the LAN card configuration program, create a network profile that has the following values:

- **Network name (SSID):** Mynetwork (example only)



**NOTE:** You should create a network name that is unique and easy for you to remember. Just remember that the network name is case-sensitive. Therefore, you must remember which letters are uppercase and lowercase.

- **Communication mode:** Ad Hoc
- **Encryption:** enabled

## Connect to a wireless ad hoc network

You can use the Wireless Setup Wizard to connect the HP All-in-One to a wireless ad hoc network.

### To connect to a wireless ad hoc network

1. On the control panel of the HP All-in-One, press **Setup**.
2. Press ▼ until **Network** is highlighted, and then press **OK**.
3. Press ▼ to highlight **Wireless Setup Wizard**, and then press **OK**.  
This runs the **Wireless Setup Wizard**. The setup wizard searches for available networks, and then displays a list of detected network names (SSIDs). The infrastructure networks appear first in the list, followed by available ad hoc networks. The networks with the strongest signal appear first, the weakest appear last.
4. On the display, look for the network name you created on your computer (for example, Mynetwork).
5. Use the arrow buttons to highlight the network name, and then press **OK**.  
If you found your network name and selected it, go on to step 6.

### If you do not see your network name in the list

- a. Select **Enter a New Network Name (SSID)**.  
The visual keyboard appears.
- b. Enter the SSID. Use the arrow buttons on the HP All-in-One control panel to highlight a letter or number on the visual keyboard, and then press **OK** to select it.



**NOTE:** You must enter the **exact** uppercase (capital) and lowercase (small) letters. Otherwise, the wireless connection will fail.

- c. When you have finished entering the new SSID, use the arrow buttons to highlight **Done** on the visual keyboard, and then press **OK**.

---

 **TIP:** If the HP All-in-One is unable to discover the network based on the network name you entered, you will see the following prompts. You may want to move the HP All-in-One closer to the computer and try running the Wireless Setup Wizard again to automatically discover the network.

---

- d. Press ▼ until **Ad Hoc** is highlighted, and then press **OK**.
- e. Press ▼ until **Yes, my network uses WEP encryption** is highlighted, and then press **OK**. The visual keyboard displays.

If you do **not** want to use WEP encryption, press ▼ until **No, my network does not use encryption** is highlighted, and then press **OK**. Go to step 7.

6. If prompted, enter your WEP key as follows. Otherwise go to step 7.
- a. Use the arrow buttons to highlight a letter or number on the visual keyboard, and then press **OK** to select it.

---

 **NOTE:** You must enter the **exact** uppercase (capital) and lowercase (small) letters. Otherwise, the wireless connection will fail.

---

- b. When you are finished entering the WEP key, use the arrow buttons to highlight **Done** on the visual keyboard.

7. Press **OK** again to confirm.

The HP All-in-One will attempt to connect to the SSID. If a message says you entered an invalid WEP key, check the key you wrote down for your new network, follow the prompts to correct the WEP key, and then try again.

8. When the HP All-in-One connects successfully to the network, go to your computer to install the software.

### Related topics

- [“Enter text using the visual keyboard” on page 19](#)
- [“Install the software for a network connection” on page 46](#)
- [“Network troubleshooting” on page 183](#)

## Install the software for a network connection

Use this section to install the HP All-in-One software on a computer connected to a network. Before you install the software, make sure you have connected the HP All-in-One to a network.

---

 **NOTE:** If your computer is configured to connect to a series of network drives, make sure that your computer is currently connected to these drives before installing the software. Otherwise, HP All-in-One installation software might try to use one of the reserved drive letters, and you will not be able to access that network drive on your computer.

**NOTE:** Installation time can range from 20 to 45 minutes depending on your operating system, the amount of available space, and the processor speed of your computer.

---

### To install the Windows HP All-in-One software

1. Quit all applications running on your computer, including any virus detection software.
2. Insert the Windows CD that came with the HP All-in-One into the CD-ROM drive on your computer and follow the onscreen instructions.
3. If a dialog box about firewalls appears, follow the instructions. If you see firewall pop-up messages, you must always accept or allow the pop-up messages.
4. On the **Connection Type** screen, select **Through the network**, and then click **Next**.  
The **Searching** screen appears as the Setup program searches for the HP All-in-One on the network.
5. On the **Printer Found** screen, verify that the printer description is correct. If more than one printer is found on the network, the **Printers Found** screen appears. Select the HP All-in-One you want to connect.
6. Follow the prompts to install the software.  
When you have finished installing the software, the HP All-in-One is ready for use.
7. If you disabled any virus detection software on your computer, make sure to enable it again.
8. To test your network connection, go to your computer and print a self-test report to the HP All-in-One.

### Connect to additional computers on a network

You can connect the HP All-in-One to more than one computer on a small network of computers. If the HP All-in-One is already connected to a computer on a network, for each additional computer you must install the HP All-in-One software. During installation of a wireless connection, the software will discover the SSID (network name) of the existing network. Once you have set up the HP All-in-One on the network you will not need to configure it again when you add additional computers.

---

 **NOTE:** You can connect the HP All-in-One to either a wireless or wired network, but not both at the same time.

---

#### Related topics

[“Install the software for a network connection” on page 46](#)

### Change the HP All-in-One from a USB connection to a network connection

If you first install the HP All-in-One with a USB connection, you can later change to either a wireless or Ethernet network connection. If you already understand how to connect to a network, you can use the general directions below.

---

 **NOTE:** For optimal performance and security in your wireless network, use an access point (such as a wireless router) to connect the HP All-in-One.

---

#### To change a USB connection to an integrated wireless WLAN 802.11 connection

1. Unplug the USB connection from the back of the HP All-in-One.
2. On the control panel of the HP All-in-One, press **Setup**.
3. Press ▼ until **Network** is highlighted, and then press **OK**.



4. Press ▼ to highlight **Wireless Setup Wizard**, and then press **OK**. This runs the **Wireless Setup Wizard**.
5. Install the software for a network connection, choose **Add a Device**, and then choose **Through the network**.
6. When the installation is complete, open **Printers and Faxes** (or **Printers**) in the **Control Panel** and delete the printers for the USB installation.

#### To change a USB connection to a wired (Ethernet) connection

1. Unplug the USB connection from the back of the HP All-in-One.
2. Connect an Ethernet cable from the Ethernet port on the back of the HP All-in-One to an available Ethernet port on the router or switch.
3. Install the software for a network connection, choose **Add a Device**, and then choose **Through the network**.
4. When the installation is complete, open **Printers and Faxes** (or **Printers**) in the **Control Panel** and delete the printers from the previous USB installation.

For more detailed instructions on connecting the HP All-in-One to a network, see:

- [“Wired network setup” on page 37](#)
- [“Integrated wireless WLAN 802.11 network setup” on page 39](#)
- [“Wireless ad hoc network setup” on page 43](#)

## Manage your network settings

You can manage network settings for the HP All-in-One through the HP All-in-One control panel. Additional advanced settings are available in the Embedded Web Server, a configuration and status tool you access from your Web browser using an existing network connection to the HP All-in-One.

This section contains the following topics:

- [Change basic network settings from the control panel](#)
- [Change advanced network settings from the control panel settings](#)
- [Use the Embedded Web Server](#)
- [Network configuration page definitions](#)

### Change basic network settings from the control panel

The HP All-in-One control panel enables you to set up and manage a wireless connection and to perform a variety of network management tasks. This includes viewing the network settings, restoring the network defaults, turning the wireless radio on and off, and changing the network settings.

This section contains the following topics:

- [Use the Wireless Setup Wizard](#)
- [View and print network settings](#)
- [Restore network defaults](#)
- [Turn the wireless radio on and off](#)
- [Print the wireless network test](#)

## Use the Wireless Setup Wizard

The Wireless Setup Wizard provides an easy way to set up and manage a wireless connection to the HP All-in-One.

### To run the Wireless Setup Wizard

1. On the control panel of the HP All-in-One, press **Setup**.
2. Press ▼ until **Network** is highlighted, and then press **OK**.
3. Press ▼ to highlight **Wireless Setup Wizard**, and then press **OK**.  
This runs the **Wireless Setup Wizard**.

### Related topics

- [“Integrated wireless WLAN 802.11 network setup”](#) on page 39
- [“Wireless ad hoc network setup”](#) on page 43

### View and print network settings

You can display a summary of the network settings on the HP All-in-One control panel, or you can print a more detailed configuration page. The network configuration page lists all of the important network settings such as the IP address, link speed, DNS, and mDNS.

### To view and print the network settings

1. On the control panel of the HP All-in-One, press **Setup**.
2. Press ▼ until **Network** is highlighted, and then press **OK**.  
The **Network** menu appears.
3. Press ▼ until **View Network Settings** is highlighted, and then press **OK**.  
The **View Network Settings** menu appears.
4. Do one of the following:
  - **To display wired network settings**, press ▼ until **Display Wired Summary** is highlighted, and then press **OK**.  
This displays a summary of the wired (Ethernet) network settings.
  - **To display wireless network settings**, press ▼ until **Display Wireless Summary** is highlighted, and then press **OK**.  
This displays a summary of the wireless network settings.
  - **To print the network configuration page**, press ▼ until **Print Network Configuration Page** is highlighted, and then press **OK**.  
This prints the network configuration page.

### Related topics

- [“Network configuration page definitions”](#) on page 53

### Restore network defaults

You can reset the network settings to what they were when you purchased the HP All-in-One.

- 
- △ **CAUTION:** This will erase all wireless setup information that you have entered. In order to restore this information, you will need to run the Wireless Setup Wizard again.
-

**To restore network defaults**

1. On the control panel of the HP All-in-One, press **Setup**.
2. Press ▼ until **Network** is highlighted, and then press **OK**.
3. Press ▼ until **Restore Network Defaults** is highlighted, and then press **OK**.
4. Press **OK** to confirm that you want to restore the network defaults.

**Turn the wireless radio on and off**

The wireless radio is off by default. In order to stay connected to a wireless network, the radio must stay on. When the radio is on, the blue light on the front of the HP All-in-One is lit. However, if the HP All-in-One is connected to a wired network or you have a USB connection, the radio is not used. In this case you might want to turn the radio off.

**To turn the wireless radio on and off**

1. On the control panel of the HP All-in-One, press **Setup**.
2. Press ▼ until **Network** is highlighted, and then press **OK**.
3. Press ▼ until **Wireless Radio** is highlighted, and then press **OK**.
4. Press ▼ to highlight **On** or **Off**, and then press **OK**.

**Print the wireless network test**

The wireless network test performs a series of diagnostic tests to determine whether network setup is successful. The wireless network test prints automatically when the Wireless Setup Wizard is run. You also can print the wireless network test at any time.

**To print the wireless test report**

1. On the control panel of the HP All-in-One, press **Setup**.
2. Press ▼ until **Network** is highlighted, and then press **OK**.
3. Press ▼ until **Wireless Network Test** is highlighted, and then press **OK**.  
The **Wireless Network Test** prints.

**Related topics**

[“Network troubleshooting” on page 183](#)

**Change advanced network settings from the control panel settings**

The advanced network settings are provided for your convenience. However, unless you are an advanced user, you should not change any of these settings.

This section contains the following topics:

- [Set link speed](#)
- [Change IP settings](#)

**Set link speed**

You can change the speed at which data is transmitted over the network. The default is **Automatic**.

### To set link speed

1. Press **Setup**.
2. Press ▼ until **Network** is highlighted, then press **OK**.  
The **Network** menu appears.
3. Press ▼ until **Advanced Setup** is highlighted, and then press **OK**.  
Press ▼ until **Set Link Speed** is highlighted, and then press **OK**.
4. Press ▼ to select the link speed that matches your network hardware, and then press **OK** to confirm the setting.
  - **Automatic**
  - **10-Full**
  - **10-Half**
  - **100-Full**
  - **100-Half**

### Change IP settings

The default setting for the IP settings is **Automatic**, which sets the IP settings automatically. However, if you are an advanced user, you might want to manually change the IP address, subnet mask, or the default gateway. To see the IP address and subnet mask of the HP All-in-One, print a network configuration page from the HP All-in-One.

---

 **NOTE:** When manually entering an IP Setting, you must already be connected to an active Network, otherwise the setting will not stay when you exit from the menu.

 **CAUTION:** Be careful when manually assigning an IP address. If you enter an invalid IP address during the installation, your network components will not be able to connect with the HP All-in-One.

---

### To change IP settings

1. Press **Setup**.
2. Press ▼ until **Network** is highlighted, then press **OK**.  
The **Network** menu appears.
3. Press ▼ until **Advanced Setup** is highlighted, and then press **OK**.
4. Press ▼ until **IP Settings** is highlighted, and then press **OK**.  
If the HP All-in-One is already connected to a wired network, you are prompted to confirm that you want to change the IP settings. Press **OK**.
5. Press ▼ until **Manual** is highlighted, and then press **OK**.
6. Press ▼ to highlight one of the following IP settings, and then press **OK**.
  - **IP Address**
  - **Subnet Mask**
  - **Default Gateway**
7. Enter your changes, and then press **OK** to confirm the setting.

### Related topics

- [“View and print network settings” on page 49](#)
- [“Network configuration page definitions” on page 53](#)

## Use the Embedded Web Server

If your computer is connected to an HP All-in-One on a network, you can access the Embedded Web Server that resides in the HP All-in-One. The Embedded Web Server is a web-based user interface that provides some options not available on the HP All-in-One control panel, including Webscan, a feature that lets you scan photos and documents from the HP All-in-One to your computer using a Web browser, and advanced network security options. Also, the Embedded Web Server enables you to monitor status and order printer supplies.

For information on how to use the features available in the Embedded Web Server, including Webscan, see the onscreen help within the Embedded Web Server. To access Embedded Web Server help, open the Embedded Web Server, then click the **Help** link under **Other Links** on the Embedded Web Server **Home** tab.

---

 **NOTE:** Use the Embedded Web Server to change network settings not available on the control panel.

---

This section contains the following topics:

- [Access the Embedded Web Server](#)
- [Use the Embedded Web Server setup wizard](#)

## Access the Embedded Web Server

The computer you use to access the Embedded Web Server on the HP All-in-One must be connected to the same network as the HP All-in-One.

### To access the Embedded Web Server

1. Print a network configuration page to find the IP address for the HP All-in-One.
2. In the **Address** box in your Web browser on your computer, type the IP address of the HP All-in-One, as shown on the network settings page. For example, `http://192.168.1.101`.

The Embedded Web Server **Home** page appears, showing information for the HP All-in-One.

---

 **NOTE:** If you are using a proxy server in your browser, you might need to disable it to access the Embedded Web Server.

---

3. If you need to change the language displayed in the Embedded Web Server, do the following:
  - a. Click the **Settings** tab.
  - b. Click **Select Language** in the **Settings** navigation menu.
  - c. In the **Select Language** list, click the appropriate language.
  - d. Click **Apply**.
4. Click the **Home** tab to access device and network information, or click the **Networking** tab to access more network information or to modify network information.
5. Make any configuration changes.
6. Close the Embedded Web Server.

### Related topics

[“View and print network settings” on page 49](#)

## Use the Embedded Web Server setup wizard

The network setup wizard provided in the Embedded Web Server gives you an intuitive interface to your network connection parameters.

### To access the Embedded Web Server setup wizard

1. Print a network configuration page to find the IP address for the HP All-in-One.
2. In the **Address** box in your Web browser on your computer, type the IP address of the HP All-in-One, as shown on the network settings page. For example, <http://192.168.1.101>.  
The Embedded Web Server **Home** page appears, showing information for the HP All-in-One.



---

**NOTE:** If you are using a proxy server in your browser, you might need to disable it to access the Embedded Web Server.

---

3. Click the **Networking** tab.
4. Click **Wired (802.3)** or **Wireless (802.11)** in the **Connections** navigation menu.
5. Click **Start Wizard**, and then follow all of the wizard instructions.

### Related topics

[“View and print network settings” on page 49](#)

### Network configuration page definitions

The network configuration page shows the network settings for the HP All-in-One. There are settings for general information, 802.3 wired (Ethernet), 802.11 wireless, and Bluetooth®.

This section contains the following topics:

- [General network settings](#)
- [Wired \(802.3\) network settings](#)
- [Wireless \(802.11\) network settings](#)
- [Bluetooth settings](#)

### Related topics

- [“View and print network settings” on page 49](#)
- [“Network glossary” on page 59](#)

## General network settings

The following table describes the general network settings shown on the network configuration page.

Parameter	Description
Network Status	Status of the HP All-in-One: <ul style="list-style-type: none"> <li>• <b>Ready:</b> The HP All-in-One is ready to receive or transmit data.</li> <li>• <b>Offline:</b> The HP All-in-One is not currently connected to the network.</li> </ul>
Active connection type	Network mode of the HP All-in-One: <ul style="list-style-type: none"> <li>• <b>Wired:</b> The HP All-in-One is connected by Ethernet cable to an IEEE 802.3 network.</li> <li>• <b>Wireless:</b> The HP All-in-One is connected to a wireless (802.11) network.</li> <li>• <b>None:</b> There is no network connection.</li> </ul>
URL	The IP address of the Embedded Web Server.  <b>NOTE:</b> You will need to know this URL when you try to access the Embedded Web Server.
Firmware Revision	The internal networking component and device firmware revision code.  <b>NOTE:</b> If you call HP Support, depending on the problem, you might be asked to provide the firmware revision code.
Hostname	The TCP/IP name assigned by the installation software to the device. By default, this is the letters HP followed by the last 6 digits of the Media Access Control (MAC) address.
Admin Password	Status of the administrator's password for the Embedded Web Server: <ul style="list-style-type: none"> <li>• <b>Set:</b> Password is specified. You must enter the password to make changes to the Embedded Web Server parameters.</li> <li>• <b>Not Set:</b> No password is set. A password is not required for making changes to the Embedded Web Server parameters.</li> </ul>
mDNS	Some local and ad hoc networks do not use central DNS servers. They use a DNS alternative called mDNS.  With mDNS, your computer can find and use any HP All-in-One connected to your local area network. It can also work with any other Ethernet-enabled device that appears on the network.

## Wired (802.3) network settings

The following table describes the 802.3 wired settings shown on the network configuration page.

Parameter	Description
Hardware Address (MAC)	The Media Access Control (MAC) address that identifies the HP All-in-One. This is a unique 12-digit identification number assigned to networking hardware for identification, including routers, switches, and other such devices. No two pieces of hardware have the same MAC address.

(continued)

Parameter	Description
	<p><b>NOTE:</b> Some Internet service providers (ISPs) require that you register the MAC address of the Network Card or LAN Adapter that was connected to your cable or DSL modem during installation.</p>
IP Address	<p>This address uniquely identifies the device on the network. IP addresses are assigned dynamically through DHCP or AutoIP. You can also set up a static IP address, though this is not recommended.</p> <p><b>CAUTION:</b> Be careful when manually assigning an IP address. An invalid IP address during installation will prevent your network components from seeing the HP All-in-One.</p>
Subnet Mask	<p>A subnet is an IP address assigned by the installation software to make an additional network available as part of a larger network. Subnets are specified by a subnet mask. This mask determines which of the HP All-in-One IP address bits identify the network and subnet, and which bits identify the device itself.</p> <p><b>NOTE:</b> It is recommended that the HP All-in-One and the computers that use it all reside on the same subnet.</p>
Default Gateway	<p>A node on a network that serves as an entrance to another network. A node in this instance can be a computer or some other device.</p> <p><b>NOTE:</b> The address of the default gateway is assigned by the installation software, unless you have already set a manual ip address.</p>
Configuration Source	<p>The protocol used to assign the IP address to the HP All-in-One:</p> <ul style="list-style-type: none"><li>• <b>AutoIP:</b> The installation software automatically determines the configuration parameters.</li><li>• <b>DHCP:</b> The configuration parameters are supplied by a dynamic host configuration protocol (DHCP) server on the network. On small networks, this could be a router.</li><li>• <b>Manual:</b> The configuration parameters are set manually, such as a static IP address.</li><li>• <b>Not Specified:</b> The mode used when the HP All-in-One is initializing.</li></ul>
DNS server	<p>The IP address of the domain name service (DNS) for the network. When you use the web or send an e-mail message, you use a domain name to do it. For example, the URL <a href="http://www.hp.com">http://www.hp.com</a> contains the domain name hp.com. The DNS on the Internet translates the domain name into an IP address. Devices use the IP addresses to refer to one another.</p> <ul style="list-style-type: none"><li>• <b>IP Address:</b> The IP address of the domain name server.</li><li>• <b>Not Specified:</b> The IP address is not specified, or the device is initializing.</li></ul> <p><b>NOTE:</b> Check to see if a DNS IP address appears on the network configuration page. If no address is shown, obtain the DNS IP address from your Internet service provider (ISP).</p>
Link Configuration	<p>The speed at which data is transmitted over a network. Speeds include <b>10TX-Full</b>, <b>10TX-Half</b>, <b>100TX-Full</b>, and <b>100TX-Half</b>. When set to <b>None</b>, networking is disabled.</p>
Total Packets transmitted	<p>The number of packets transmitted by the HP All-in-One without error since it has been turned on. The counter clears after the HP All-in-One is turned off. When a message is transmitted over a packet-switching network, it is</p>



(continued)

Parameter	Description
	broken up into packets. Each packet contains the destination address as well as the data.
Total Packets received	The number of packets received by the HP All-in-One without error since it has been turned on. The counter clears after the HP All-in-One is turned off.

### Wireless (802.11) network settings

The following table describes the 802.11 wireless settings shown on the network configuration page.

Parameter	Description
Hardware Address (MAC)	<p>The Media Access Control (MAC) address that identifies the HP All-in-One. This is a unique 12-digit identification number assigned to networking hardware for identification, including wireless access points, routers, and other such devices. No two pieces of hardware have the same MAC address. Two MAC addresses are assigned: one for wired Ethernet and one for wireless 802.11.</p> <p><b>NOTE:</b> Some Internet service providers (ISPs) require that you register the MAC address of the Network Card or LAN Adapter that was connected to your cable or DSL modem during installation.</p>
IP Address	<p>This address uniquely identifies the device on the network. IP addresses are assigned dynamically through DHCP or AutoIP. You can also set up a static IP address, though this is not recommended.</p> <p><b>NOTE:</b> Manually assigning an invalid IP address during installation will prevent your network components from seeing the HP All-in-One.</p>
Subnet Mask	<p>A subnet is an IP address assigned by the installation software to make an additional network available as part of a larger network. Subnets are specified by a subnet mask. This mask determines which of the HP All-in-One IP address bits identify the network and subnet, and which bits identify the device itself.</p> <p><b>NOTE:</b> It is recommended that the HP All-in-One and the computers that use it all reside on the same subnet.</p>
Default Gateway	<p>A node on a network that serves as an entrance to another network. A node in this instance can be a computer or some other device.</p> <p><b>NOTE:</b> The address of the default gateway is assigned by the installation software.</p>
Configuration Source	<p>The protocol used to assign the IP address to the HP All-in-One:</p> <ul style="list-style-type: none"> <li>• <b>AutoIP:</b> The installation software automatically determines the configuration parameters.</li> <li>• <b>DHCP:</b> The configuration parameters are supplied by a dynamic host configuration protocol (DHCP) server on the network. On small networks, this could be a router.</li> <li>• <b>Manual:</b> The configuration parameters are set manually, such as a static IP address.</li> <li>• <b>Not Specified:</b> The mode used when the HP All-in-One is initializing.</li> </ul>

(continued)

Parameter	Description
DNS server	<p>The IP address of the domain name service (DNS) for the network. When you use the Web or send an e-mail message, you use a domain name to do it. For example, the URL <a href="http://www.hp.com">http://www.hp.com</a> contains the domain name <a href="http://www.hp.com">hp.com</a>. The DNS on the Internet translates the domain name into an IP address. Devices use the IP addresses to refer to one another.</p> <ul style="list-style-type: none"><li>• <b>IP Address:</b> The IP address of the domain name server.</li><li>• <b>Not Specified:</b> The IP address is not specified, or the device is initializing.</li></ul> <hr/> <p><b>NOTE:</b> Check to see if a DNS IP address appears on the network configuration page. If no address is shown, obtain the DNS IP address from your Internet service provider (ISP).</p>
Wireless Status	<p>Status of the wireless network:</p> <ul style="list-style-type: none"><li>• <b>Connected:</b> The HP All-in-One is connected to a wireless LAN and everything is working.</li><li>• <b>Disconnected:</b> The HP All-in-One is not connected to the wireless LAN due to incorrect settings (such as the wrong WEP key), the HP All-in-One is out of range, or an Ethernet cable is plugged in and connected to an active network.</li><li>• <b>Disabled:</b> The radio is turned off.</li><li>• <b>Not applicable:</b> This parameter does not apply to this network type.</li></ul>
Communication Mode	<p>An IEEE 802.11 networking framework in which devices or stations communicate with each other:</p> <ul style="list-style-type: none"><li>• <b>Infrastructure:</b> The HP All-in-One communicates with other network devices through a wireless access point, such as a wireless router or base station.</li><li>• <b>Ad hoc:</b> The HP All-in-One communicates directly with each device on the network. No wireless router or access point is used. This is also called a peer-to-peer network.</li><li>• <b>Not applicable:</b> This parameter does not apply to this network type.</li></ul>
Network Name (SSID)	<p>Service Set Identifier. A unique identifier (up to 32 characters) that differentiates one wireless local area network (WLAN) from another. The SSID is also referred to as the network name. This is the name of the network to which the HP All-in-One is connected.</p>
Signal Strength (1-5)	<p>The transmitting or return signal graded on a scale of 1 to 5:</p> <ul style="list-style-type: none"><li>• <b>5:</b> Excellent</li><li>• <b>4:</b> Good</li><li>• <b>3:</b> Fair</li><li>• <b>2:</b> Poor</li><li>• <b>1:</b> Marginal</li><li>• <b>No signal:</b> No signal detected on the network.</li><li>• <b>Not applicable:</b> This parameter does not apply to this network type.</li></ul>
Channel	<p>The channel number currently being used for wireless communication. This depends on the network in use, and might differ from the requested channel</p>

(continued)

Parameter	Description
	<p>number. Value is from 1 to 14; countries/regions might limit the range of approved channels.</p> <ul style="list-style-type: none"> <li>• <b>(number):</b> Value ranging from 1 to 14, depending on country/region.</li> <li>• <b>None:</b> No channel is in use.</li> <li>• <b>Not Applicable:</b> The WLAN is disabled or this parameter does not apply to this network type.</li> </ul> <hr/> <p><b>NOTE:</b> In ad hoc mode, if you are not able to receive or transmit data between your computer and the HP All-in-One, make sure that you are using the same communication channel on your computer and the HP All-in-One. In infrastructure mode, the channel is dictated by the access point.</p>
Authentication type	<p>Type of authentication in use:</p> <ul style="list-style-type: none"> <li>• <b>None:</b> No authentication in use.</li> <li>• <b>Open System</b> (ad hoc and infrastructure): No authentication</li> <li>• <b>Shared Key:</b> WEP key is required.</li> <li>• <b>WPA-PSK</b> (infrastructure only): WPA with Pre-Shared Key.</li> <li>• <b>Not applicable:</b> This parameter does not apply to this network type.</li> </ul> <p>Authentication verifies the identity of a user or device before granting access to the network, making it more difficult for unauthorized users to access network resources. This security method is common on wireless networks.</p> <p>A network using <b>Open System</b> authentication does not screen network users based on their identities. Any wireless user can have access from the network. However, such a network might use WEP (Wired Equivalent Privacy) encryption to provide a first level of security against casual eavesdroppers.</p> <p>A network using <b>Shared Key</b> authentication provides increased security by requiring users or devices to identify themselves with a static key (a hexadecimal or alphanumeric string). Every user or device on the network shares the same key. WEP encryption is used along with shared key authentication, using the same key for both authentication and encryption.</p> <p>A network using server-based (<b>WPA-PSK</b>) authentication provides significantly stronger security, and is supported in most wireless access points and wireless routers. The access point or router verifies the identity of a user or device requesting access to the network before granting that access. Several different authentication protocols might be used on an authentication server.</p>
Encryption	<p>The type of encryption in use on the network:</p> <ul style="list-style-type: none"> <li>• <b>None:</b> No encryption is in use.</li> <li>• <b>64-bit WEP:</b> A 5-character or 10-hex-digit WEP key is in use.</li> <li>• <b>128-bit WEP:</b> A 13-character or 26-hex-digit WEP key is in use.</li> <li>• <b>WPA-AES:</b> Advanced Encryption Standard encryption is in use. This is an encryption algorithm for securing sensitive but unclassified material by US Government agencies.</li> <li>• <b>WPA-TKIP:</b> Temporal Key Integrity Protocol, an advanced encryption protocol, is in use.</li> <li>• <b>Automatic:</b> AES or TKIP is in use.</li> <li>• <b>Not applicable:</b> This parameter does not apply to this network type.</li> </ul> <p>WEP aims to provide security by encrypting data over radio waves so that it is protected as it is transmitted from one end point to another. This security method is common on wireless networks.</p>

(continued)

Parameter	Description
Access Point HW Address	The hardware address of the wireless router or access point on the network to which the HP All-in-One is connected: <ul style="list-style-type: none"><li>• <b>(MAC address):</b> The unique MAC (Media Access Control) hardware address of the access point.</li><li>• <b>Not applicable:</b> This parameter does not apply to this network type.</li></ul>
Total Packets transmitted	The number of packets transmitted by the HP All-in-One without error since it has been turned on. The counter clears after the HP All-in-One is turned off. When a message is transmitted over a packet-switching network, it is broken up into packets. Each packet contains the destination address as well as the data.
Total Packets received	The number of packets received by the HP All-in-One without error since it has been turned on. The counter clears after the HP All-in-One is turned off.

### Bluetooth settings

The following table describes the Bluetooth settings shown on the network configuration page.

Parameter	Description
Device Address	The hardware address of the Bluetooth device.
Device Name	The device name assigned to the printer, which can identify it on a Bluetooth device.
Passkey	A value that the user must enter in order to print via Bluetooth.
Visibility	Shows whether or not the HP All-in-One is visible to Bluetooth devices that are within range. <ul style="list-style-type: none"><li>• <b>Visible to all:</b> Any Bluetooth device within range can print to the HP All-in-One.</li><li>• <b>Not visible:</b> Only Bluetooth devices that have stored the device address of the HP All-in-One can print to it.</li></ul>
Security	The level of security set for an HP All-in-One connected by Bluetooth. <ul style="list-style-type: none"><li>• <b>Low:</b> The HP All-in-One does not require a passkey. Any Bluetooth device within range can print to it.</li><li>• <b>High:</b> The HP All-in-One requires a passkey from the Bluetooth device before allowing the device to send a print job.</li></ul>

### Network glossary

access point	A network router that has wireless capability.
ASCII	American Standard Code for Information Interchange. The standard for numbers used by computers to represent all the uppercase and lowercase Latin letters, numbers, punctuation, etc.
AutoIP	A feature of the installation software, which determines the configuration parameters of devices on the network.

(continued)

DHCP	Dynamic Host Configuration Protocol. A server on the network that supplies configuration parameters to devices on the network. On small networks, this could be a router.
DNS	Domain Name Service. When you use the Web or send an e-mail message, you use a domain name to do it. For example, the URL <a href="http://www.hp.com">http://www.hp.com</a> contains the domain name hp.com. The DNS on the Internet translates the domain name into an IP address. Devices use the IP addresses to refer to one another.
DNS-SD	See DNS. The SD portion stands for Service Discovery. This is part of a protocol developed by Apple that enables automatic discovery of computers, devices, and services on IP networks.
DSL	Digital Subscriber Line. A high-speed connection to the Internet.
Ethernet	The most common local network technology that connects computers using copper cabling.
Ethernet cable	The cable used to connect network elements in a wired network. The CAT-5 Ethernet cable is also known as a straight-through cable. When using an Ethernet cable, the network elements must be attached to a router. An Ethernet cable uses an RJ-45 connector.
EWS	Embedded Web Server. A browser-based utility that provides a simple way to manage the HP All-in-One. You can monitor status, configure HP All-in-One networking parameters, or access HP All-in-One features.
Gateway	A computer or other device, such as a router, that serves as an entrance to the Internet or another network.
HEX	Hexadecimal. The base 16 numbering system, which uses the digits 0-9 plus the letters A-F.
host computer	The computer at the center of a network.
Hostname	The TCP/IP name assigned by the installation software to the device. By default, this is the letters HP followed by the last 6 digits of the Media Access Control (MAC) address.
hub	No longer commonly used in modern home networks, a hub takes its signal from each computer and sends it to all of the other computers connected to the hub. Hubs are passive; other devices on the network plug into the hub in order to communicate with one another. A hub does not manage the network.
IP address	A number that uniquely identifies the device on the network. IP addresses are assigned dynamically through DHCP or AutoIP. You can also set up a static IP address, though this is not recommended.
MAC address	Media Access Control (MAC) address that uniquely identifies the HP All-in-One. This is a unique 12-digit identification number assigned to networking hardware for identification. No two pieces of hardware have the same MAC address.
network name	The SSID or network name identifies a wireless network.
NIC	Network Interface Card. A card on your computer that provides an Ethernet connection so that you can connect your computer to a network.
RJ-45 connector	The connector on the ends of an Ethernet cable. Although standard Ethernet cable connectors (RJ-45 connectors) look similar to standard telephone cable connectors, they are not interchangeable. An RJ-45 connector is wider and thicker and always has 8 contacts on the end. A phone connector has between 2 and 6 contacts.

(continued)

router	A router provides a bridge between two or more networks. A router can link a network to the Internet, link two networks and connect both to the Internet, and help secure networks through the use of firewalls and assigning dynamic addresses. A router can also act as a gateway, while a switch cannot.
SSID	The SSID or network name identifies a wireless network.
switch	A switch makes it possible for several users to send information over a network at the same time without slowing each other down. Switches allow different nodes (a network connection point, typically a computer) of a network to communicate directly with one another.
WEP	Wired Equivalent Privacy (WEP) is a type of encryption used for wireless network security.
WPA	Wi-Fi Protected Access (WPA) is a type of encryption used for wireless network security. WPA offers greater security than WEP.

## Fax setup

After completing all the steps in the Setup Guide, use the instructions in this section to complete your fax setup. Please keep your Setup Guide for later use.

In this section, you will learn how to set up the HP All-in-One so that faxing works successfully with equipment and services you might already have on the same phone line as the HP All-in-One.

 **NOTE:** Refer to your printed documentation for complete step-by-step instructions on setting up and configuring the HP All-in-One for faxing with other telephone or office equipment and services.

For fax setup information in specific countries/regions, you can also see the Fax Configuration Web site listed below.

Austria	<a href="http://www.hp.com/at/faxconfig">www.hp.com/at/faxconfig</a>
Germany	<a href="http://www.hp.com/de/faxconfig">www.hp.com/de/faxconfig</a>
Switzerland (French)	<a href="http://www.hp.com/ch/fr/faxconfig">www.hp.com/ch/fr/faxconfig</a>
Switzerland (German)	<a href="http://www.hp.com/ch/de/faxconfig">www.hp.com/ch/de/faxconfig</a>
United Kingdom	<a href="http://www.hp.com/uk/faxconfig">www.hp.com/uk/faxconfig</a>
Spain	<a href="http://www.hp.es/faxconfig">www.hp.es/faxconfig</a>
The Netherlands	<a href="http://www.hp.nl/faxconfig">www.hp.nl/faxconfig</a>
Belgium (France)	<a href="http://www.hp.be/fr/faxconfig">www.hp.be/fr/faxconfig</a>
Belgium (Dutch)	<a href="http://www.hp.be/nl/faxconfig">www.hp.be/nl/faxconfig</a>
Portugal	<a href="http://www.hp.pt/faxconfig">www.hp.pt/faxconfig</a>
Sweden	<a href="http://www.hp.se/faxconfig">www.hp.se/faxconfig</a>
Finland	<a href="http://www.hp.fi/faxconfig">www.hp.fi/faxconfig</a>
Denmark	<a href="http://www.hp.dk/faxconfig">www.hp.dk/faxconfig</a>

(continued)

Norway	<a href="http://www.hp.no/faxconfig">www.hp.no/faxconfig</a>
Ireland	<a href="http://www.hp.com/ie/faxconfig">www.hp.com/ie/faxconfig</a>
France	<a href="http://www.hp.com/fr/faxconfig">www.hp.com/fr/faxconfig</a>
Italy	<a href="http://www.hp.com/it/faxconfig">www.hp.com/it/faxconfig</a>

This section contains the following topics:

- [Change settings on the HP All-in-One to receive faxes](#)
- [Test your fax setup](#)
- [Set the fax header](#)
- [Set up speed dialing](#)

### Related topics

[“Use the fax features”](#) on page 131

## Change settings on the HP All-in-One to receive faxes

In order to receive faxes successfully, you might need to change some settings on the HP All-in-One. If you are unsure which setting to choose for a specific fax option, refer to the detailed fax setup instructions provided in the printed documentation.

This section contains the following topics:

- [Set the answer mode](#)
- [Set the number of rings before answering](#)
- [Change the answer ring pattern for distinctive ringing](#)

### Set the answer mode

The answer mode determines whether the HP All-in-One answers incoming calls or not.

- Turn on the **Auto Answer** setting if you want the HP All-in-One to answer faxes **automatically**. The HP All-in-One will answer all incoming calls and faxes.
- Turn off the **Auto Answer** setting if you want to receive faxes **manually**. You must be available to respond in person to the incoming fax call or the HP All-in-One will not receive faxes.

#### To set the answer mode

- ▲ Press **Auto Answer** to turn the light on or off, as appropriate for your setup. When the **Auto Answer** light is on, the HP All-in-One answers calls automatically. When the light is off, the HP All-in-One does not answer calls.

### Set the number of rings before answering

If you turn on the **Auto Answer** setting, you can specify how many rings should occur before the HP All-in-One automatically answers the incoming call.

The **Rings to Answer** setting is important if you have an answering machine on the same phone line as the HP All-in-One, because you want the answering machine to answer the phone before the HP All-in-One does. The number of rings to answer for the HP All-in-One should be greater than the number of rings to answer for the answering machine.

For example, set your answering machine to a low number of rings and the HP All-in-One to answer in the maximum number of rings. (The maximum number of rings varies by country/region.) In this setup, the answering machine will answer the call and the HP All-in-One will monitor the line. If the HP All-in-One detects fax tones, the HP All-in-One will receive the fax. If the call is a voice call, the answering machine will record the incoming message.

### To set the number of rings before answering from the control panel

1. Press **Setup**.
2. Press ▼ to highlight **Basic Fax Setup** and press **OK**.
3. Press ▼ to highlight **Rings to Answer** and then press **OK**.
4. Enter the appropriate number of rings by using the keypad, or press ▼ or ▲ to change the number of rings.
5. Press **OK** to accept the setting.

### Change the answer ring pattern for distinctive ringing

Many phone companies offer a distinctive ringing feature that allows you to have several phone numbers on one phone line. When you subscribe to this service, each number will have a different ring pattern. You can set up the HP All-in-One to answer incoming calls that have a specific ring pattern.

If you connect the HP All-in-One to a line with distinctive ringing, have your telephone company assign one ring pattern to voice calls and another ring pattern to fax calls. HP recommends that you request double or triple rings for a fax number. When the HP All-in-One detects the specified ring pattern, it will answer the call and receive the fax.

If you do not have a distinctive ring service, use the default ring pattern, which is **All Rings**.

### To change the distinctive ring pattern from the control panel

1. Verify that the HP All-in-One is set to answer fax calls automatically.
2. Press **Setup**.
3. Press ▼ to highlight **Distinctive Ring**, and then press **OK**.
4. Press ▼ to highlight **Advanced Fax Setup**, and then press **OK**.
5. Press ▼ to highlight the appropriate option, and then press **OK**.  
When the phone rings with the ring pattern assigned to your fax line, the HP All-in-One answers the call and receives the fax.

## Test your fax setup

You can test your fax setup to check the status of the HP All-in-One and to make sure it is set up properly for faxing. Perform this test after you have completed setting up the HP All-in-One for faxing. The test does the following:

- Tests the fax hardware
- Verifies the correct type of phone cord is connected to the HP All-in-One
- Checks that the phone cord is plugged into the correct port
- Checks for a dial tone



- Checks for an active phone line
- Tests the status of your phone line connection

The HP All-in-One prints a report with the results of the test. If the test fails, review the report for information on how to fix the problem and rerun the test.

### To test your fax setup from the control panel

1. Set up the HP All-in-One for faxing according to your particular home or office setup instructions.
2. Insert the ink cartridges and load full-size paper in the input tray before starting the test.
3. Press **Setup**.
4. Press ▼ to highlight **Tools**, and then press **OK**.
5. Press ▼ to highlight **Run Fax Test**, and then press **OK**.  
The HP All-in-One displays the status of the test on the display and prints a report.
6. Review the report.
  - If the test passes and you are still having problems faxing, check the fax settings listed in the report to verify the settings are correct. A blank or incorrect fax setting can cause problems faxing.
  - If the test fails, review the report for more information on how to fix any problems found.
7. After you pick up the fax report from the HP All-in-One, press **OK**.  
If necessary, resolve any problems found and rerun the test.

## Set the fax header

The fax header prints your name and fax number on the top of every fax you send. HP recommends that you set up the fax header by using the software that you installed with the HP All-in-One. You can also set up the fax header from the control panel, as described here.

---

 **NOTE:** In some countries/regions the fax header information is a legal requirement.

---

### To set a default fax header from the control panel

1. Press **Setup**.
2. Press ▼ to highlight **Basic Fax Setup** and press **OK**.
3. Press ▼ to highlight **Fax Header**, and then press **OK**.  
The visual keyboard appears on the display.
4. Use the visual keyboard to enter your personal or company name. When you are finished, highlight **Done** on the visual keyboard, and then press **OK**.
5. Enter your fax number by using the numeric keypad, and then press **OK**.

### Related topics

[“Enter text using the visual keyboard” on page 19](#)

## Set up speed dialing

You can assign speed dial entries to fax numbers you use often. This lets you dial those numbers quickly by using the control panel.

This section contains the following topics:

- [Set up individual speed dial entries](#)
- [Set up group speed dial entries](#)
- [Delete speed dial entries](#)
- [Print the speed dial list](#)

### Set up individual speed dial entries

You can create speed dial entries for fax numbers that you use frequently. If necessary, you can also edit the name or fax number of a speed dial entry you have already created.

 **TIP:** You can include individual speed dial entries in a group speed dial entry. This enables you to send a fax to a group of people at one time. (The maximum number of individual speed dial entries allowed in a group speed dial entry varies by model.)

This section contains the following topics:

- [Create individual speed dial entries](#)
- [Update individual speed dial entries](#)

### Create individual speed dial entries

You can create speed dial entries from the control panel or from your computer by using the software that you installed with the HP All-in-One.

#### To create speed dial entries from the control panel

1. Press **Setup**.
2. Press **▼** to highlight **Speed Dial Setup**, and then press **OK**.
3. Press **▼** to highlight **Individual Speed Dial**, and then press **OK**.  
The first unassigned speed dial entry appears on the display.
4. Press **OK** to select the displayed speed dial entry. You can also press **▼** to highlight a different unassigned entry, and then press **OK**.
5. Enter the fax number for the speed dial entry by using the numeric keypad, and then press **OK**.

 **TIP:** To add a pause in the fax number you are entering, press the **Symbols (\*)** button repeatedly until a dash (-) appears on the display.

The visual keyboard appears on the display.

6. Use the visual keyboard to enter the name. When you are finished, highlight **Done** on the visual keyboard, and then press **OK**.
7. Press **OK** if you want to set up another number.

### Related topics

[“Enter text using the visual keyboard” on page 19](#)

## Update individual speed dial entries

You can edit the name or fax number in a speed dial entry from the control panel or from your computer by using the software that you installed with the HP All-in-One.

### To update a speed dial entry from the control panel

1. Press **Setup**.
2. Press ▼ to highlight **Speed Dial Setup**, and then press **OK**.
3. Press ▼ to highlight **Individual Speed Dial**, and then press **OK**.  
The first unassigned speed dial entry appears on the display.
4. Press ▼ or ▲ to scroll through the speed dial entries, and then press **OK** to select the appropriate entry.
5. When the current fax number appears, press ◀ to erase it.
6. Enter the new fax number by using the numeric keypad, and then press **OK**.

---

 **TIP:** To add a pause in the fax number you are entering, press the **Symbols (\*)** button repeatedly until a dash (-) appears on the display.

---

The visual keyboard appears on the display.

7. Use the visual keyboard to enter a new name. When you are finished, highlight **Done** on the visual keyboard, and then press **OK**.
8. Press **OK** if you want to update another number.

### Related topics

- [“Text and symbols” on page 18](#)
- [“Enter text using the visual keyboard” on page 19](#)

## Set up group speed dial entries

You can place individual speed dial entries that you have set up into groups, so that you can fax the same document to multiple recipients at once. (The maximum number of individual speed dial entries allowed in a group speed dial entry varies by model.)

---

 **NOTE:** The numbers you include in the group speed dial entry must already be set up as individual speed dial entries on the HP All-in-One.

 **TIP:** You can send a one time only fax to multiple recipients by using the **Broadcast Fax** feature. The **Broadcast Fax** recipient list is not saved and only works for sending faxes in black.

---

### To create group speed dial entries from the control panel

1. Press **Setup**.
2. Press ▼ to highlight **Speed Dial Setup**, and then press **OK**.
3. Press ▼ to highlight **Group Speed Dial**, and then press **OK**.  
The first unassigned speed dial entry appears on the display.
4. Press **OK** to select the displayed speed dial entry. You can also press ▼ to highlight a different unassigned entry, and then press **OK**.

5. Press ▼ or ▲ to scroll through the individual speed dial entries you set up, and then press **OK** to select the appropriate entry. Repeat this step for each number you want to add to the group speed dial.
6. When you are done, press ▲ to highlight **Done Selecting**, and then press **OK**. The visual keyboard appears on the display.
7. Use the visual keyboard to enter a name for the group speed dial. When you are finished, highlight **Done** on the visual keyboard, and then press **OK**.
8. Press **OK** to add another group.

### Related topics

- [“Enter text using the visual keyboard” on page 19](#)
- [“Broadcast a fax to multiple recipients” on page 136](#)

### Delete speed dial entries

You can delete an individual or group speed dial entry. When deleting speed dial entries, consider the following:

- Deleting an individual speed dial entry also deletes that entry from any groups to which you have assigned it.
- Deleting a group speed dial entry does not delete the individual speed dial entries associated with it. You can still use the individual speed dial entries to send faxes.

### To delete speed dial entries from the control panel

1. Press **Setup**.
2. Press ▼ to highlight **Speed Dial Setup**, and then press **OK**.
3. Press ▼ to highlight **Delete Speed Dial**, and then press **OK**.
4. Press ▼ to highlight the speed dial entry that you want to delete, and then press **OK**.

### Print the speed dial list

You can print a list of all the speed dial entries that you programmed on the HP All-in-One.

### To print the speed dial list

1. Press **Setup**.
2. Press ▼ to highlight **Speed Dial Setup**, and then press **OK**.
3. Press ▼ to highlight **Print Speed Dial List**, and then press **OK**.



**TIP:** You can also print this list by selecting **Speed Dial List** from the **Print Report** menu.



---

# 5 How do I?

This section contains links to commonly performed tasks, such as printing photos, scanning, making copies, and faxing.

- [“How do I print 10 x 15 cm \(4 x 6\) inch borderless photos from a memory card?”](#) on page 104
- [“How do I make reprints of a photo in a variety of sizes?”](#) on page 115
- [“How do I make a black-and-white or color copy of a document?”](#) on page 121
- [“How do I print 13 x 18 cm \(5 x 7\) inch or larger size photos from a memory card?”](#) on page 104
- [“How do I save photos to my computer?”](#) on page 108
- [“How do I share my photos with family and friends?”](#) on page 107
- [“How do I scan a photo or document to the computer?”](#) on page 117
- [“How do I print on both sides of the paper?”](#) on page 93
- [“How do I print wide-rule notebook paper and graph paper for my child's homework project?”](#) on page 153
- [“How do I test my fax setup?”](#) on page 63
- [“How do I send a basic fax?”](#) on page 131
- [“How do I manually send a fax?”](#) on page 133
- [“How do I use a credit card when sending a fax?”](#) on page 134
- [“How do I broadcast a fax to multiple recipients?”](#) on page 136
- [“How do I manually receive a fax?”](#) on page 140
- [“How do I print a fax confirmation report?”](#) on page 150



---

## 6 Load originals and load paper

You can load many different types and sizes of paper in the HP All-in-One, including letter or A4 paper, legal paper, photo paper, transparencies, envelopes, and HP CD/DVD tattoo labels. By default, the HP All-in-One is set to detect the size and type of paper you load in the input tray automatically and then adjust its settings to generate the highest quality output for that paper.

If you are using special papers, such as photo paper, transparency film, envelopes, or labels, or if you experience poor print quality using the automatically-adjusted settings, you can manually set the paper size and type for print and copy jobs.

This section contains the following topics:

- [Load originals](#)
- [Choose papers for printing and copying](#)
- [Load paper](#)
- [Avoid paper jams](#)

### Load originals

You can load an original for a copy, fax, or scan job in the automatic document feeder or on the glass. Originals that are loaded in the automatic document feeder will automatically be fed into the HP All-in-One.

This section contains the following topics:

- [Load an original in the automatic document feeder](#)
- [Load an original on the glass](#)

### Load an original in the automatic document feeder

You can copy, scan, or fax a single- or multiple-page letter-, A4-, or legal-size document by placing it in the document feeder tray.

The automatic document feeder holds up to 50 sheets of letter or A4 paper, or 35 sheets of legal paper.



 **NOTE:** Some features, such as the **Fit to Page** copy feature, do not work when you load your originals in the automatic document feeder. You must load your originals on the glass.

 **CAUTION:** Do not load photos in the automatic document feeder; this might cause damage to your photos.

---



### To load an original in the document feeder tray

1. Load your original, with the print side up, into the document feeder tray. Slide the paper into the automatic document feeder until you hear a beep or see a message on the display indicating that the HP All-in-One detected the pages you loaded. If you are loading legal paper, flip open the feeder tray extender before loading the paper.

---

 **TIP:** For more help on loading originals in the automatic document feeder, refer to the diagram engraved in the document feeder tray.

---

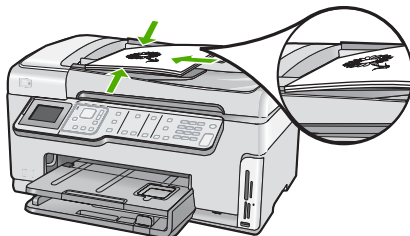

2. Slide the paper guides inward until they stop at the left and right edges of the paper.

 **NOTE:** Remove all originals from the document feeder tray before lifting the lid on the HP All-in-One.

---

### Load an original on the glass

You can copy, scan, or fax up to letter- or A4-size originals by loading them on the glass. If your original is legal-size or contains multiple full-size pages, load it in the automatic document feeder.

 **NOTE:** Many of the special features will not work correctly if the glass and lid backing are not clean.

---

### To load an original on the glass

1. Remove all originals from the document feeder tray, and then lift the lid on the HP All-in-One.
2. Load your original print side down on the right front corner of the glass.

 **TIP:** For more help on loading an original, refer to the engraved guides along the edge of the glass.

---

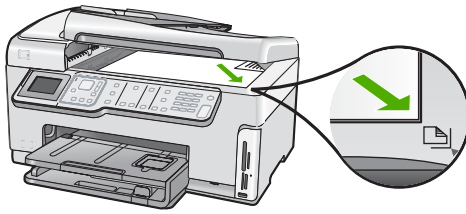

3. Close the lid.

## Choose papers for printing and copying

You can use different types and sizes of paper in the HP All-in-One. Review the following recommendations to get the best printing and copying quality. Whenever you change paper types or sizes, remember to change those settings.

This section contains the following topics:

- [Recommended papers for printing and copying](#)
- [Recommended papers for printing only](#)
- [Papers to avoid](#)

### Recommended papers for printing and copying

If you want the best print quality, HP recommends using HP papers that are specifically designed for the type of project you are printing. If you are printing photos, for example, load HP Premium or HP Premium Plus photo paper in the input tray.

#### HP Premium Plus Photo Paper

HP Premium Plus Photo Papers are the best HP photo paper, with image quality and fade resistance superior to store-processed photos. They are ideal for printing your high-resolution images for framing or including in a photo album. These papers are available in several sizes, including 10 x 15 cm (4 x 6 inch) (with or without tabs), A4, and 8.5 x 11 inch sizes for printing or copying photos from the HP All-in-One.

#### HP Premium Photo Paper

HP Premium Photo Papers are high-quality, glossy-finish or soft gloss-finish photo papers. They look and feel like store-processed photos and can be mounted under glass or in an album. These papers are available in several sizes, including 10 x 15 cm (4 x 6 inch) (with or without tabs), A4, and 8.5 x 11 inch sizes for printing or copying photos from the HP All-in-One.

#### HP Advanced Photo Paper or HP Photo Paper

HP Advanced Photo Paper or HP Photo Paper is a sturdy, glossy photo paper that features an instant-dry finish for easy handling without smudging. It resists water, smears, fingerprints, and humidity. Your prints have a look and feel comparable to a store-processed photo. It is available in several sizes, including A4, 8.5 x 11 inch, and 10 x 15 cm (4 x 6 inch) (with or without tabs) for printing or copying photos from the HP All-in-

One. HP Advanced Photo Paper is marked on the nonprinting corners with the following symbol.



### **HP Premium Inkjet Transparency Film and HP Premium Plus Inkjet Transparency Film**

HP Premium Inkjet Transparency Film and HP Premium Plus Inkjet Transparency Film make your color presentations vivid and even more impressive. This film is easy to use and handle and dries quickly without smudging.

### **HP Premium Inkjet Paper**

HP Premium Inkjet Paper is the ultimate coated paper for high-resolution usage. A smooth, matte finish makes it ideal for your highest-quality documents.

### **HP Bright White Inkjet Paper**

HP Bright White Inkjet Paper delivers high-contrast colors and sharp text. It is opaque enough for two-sided color usage with no show-through, which makes it ideal for newsletters, reports, and flyers.

### **HP All-in-One Paper or HP Printing Paper**

- HP All-in-One Paper is specifically designed for HP All-in-One devices. It has an extra bright blue-white shade that produces sharper text and richer colors than ordinary multifunction papers.
- HP Printing Paper is a high-quality multifunction paper. It produces documents that look and feel more substantial than documents printed on standard multipurpose or copy paper.

To order genuine HP supplies for the HP All-in-One, go to [www.hp.com/buy/supplies](http://www.hp.com/buy/supplies). If prompted, choose your country/region, follow the prompts to select your product, and then click one of the shopping links on the page.

## **Recommended papers for printing only**

Certain papers are supported only when you start the print job from your computer. The following list provides information about these papers.

If you want the best print quality, HP recommends using HP papers. Using paper that is too thin or too thick, paper that has a slick texture, or paper that stretches easily can cause paper jams. Using paper that has a heavy texture or does not accept ink can cause printed images to smear, bleed, or not fill in completely.

Depending on your country/region, some of these papers might not be available.

### **HP Iron-On Transfers**

HP Iron-On Transfers (for color fabrics or for light or white fabrics) are the ideal solution for creating custom T-shirts from your digital photos.

## HP Premium Photo Cards

HP Premium Photo Cards enable you to make your own greeting cards.

## HP Brochure & Flyer Paper

HP Brochure & Flyer Paper (Gloss or Matte) is glossy-coated or matte-coated on both sides for two-sided use. They are the perfect choice for near-photographic reproductions and business graphics for report covers, special presentations, brochures, mailers, and calendars.

## HP Premium Presentation Paper

HP Premium Presentation Paper gives your presentation a quality look and feel.

## HP CD/DVD Tattoos

HP CD/DVD Tattoos allow you to personalize your CDs and DVDs by printing high-quality, low-cost CD or DVD labels.

To order genuine HP supplies for the HP All-in-One, go to [www.hp.com/buy/supplies](http://www.hp.com/buy/supplies). If prompted, choose your country/region, follow the prompts to select your product, and then click one of the shopping links on the page.

## Papers to avoid

Using paper that is too thin or too thick, paper that has a slick texture, or paper that stretches easily can cause paper jams. Using paper that has a heavy texture or does not accept ink can cause printed images to smear, bleed, or not fill in completely.

### Papers to avoid for all print and copy jobs

- Any size paper other than those listed in the HP All-in-One printer software.
- Paper with cutouts or perforations (unless specifically designed for use with HP inkjet devices).
- Highly textured stock, such as linen. It might not print evenly, and the ink can bleed into these papers.
- Extremely smooth, shiny, or coated papers not specifically designed for the HP All-in-One. They can jam the HP All-in-One or repel the ink.
- Multi-part forms, such as duplicate and triplicate forms. They can wrinkle or get stuck, and the ink is more likely to smear.
- Envelopes with clasps or windows. They can get stuck in the rollers and cause paper jams.
- Banner paper.

### Additional papers to avoid when copying

- Envelopes.
- Transparency film other than HP Premium Inkjet Transparency Film or HP Premium Plus Inkjet Transparency Film.
- Iron-On Transfers.
- Greeting card paper.

- Inkjet labels.
- HP CD/DVD tattoo labels.

## Load paper

This section describes the procedure for loading different types and sizes of paper into the HP All-in-One for your copies or printouts.

 **TIP:** To help prevent rips, wrinkles, and curled or bent edges, store all paper flat in a resealable bag. If the paper is not stored properly, extreme changes in temperature and humidity might result in curled paper that does not work well in the HP All-in-One.

This section contains the following topics:

- [Load full-size paper](#)
- [Load 10 x 15 cm \(4 x 6 inch\) photo paper](#)
- [Load postcards, Hagaki, or index cards](#)
- [Load envelopes](#)
- [Load other types of paper](#)

### Load full-size paper

You can load many types of letter, A4, or legal paper into the main input tray of the HP All-in-One.



#### To load full-size paper

1. Pull out the main input tray, and then slide the paper-width and paper-length guides to their outermost positions.

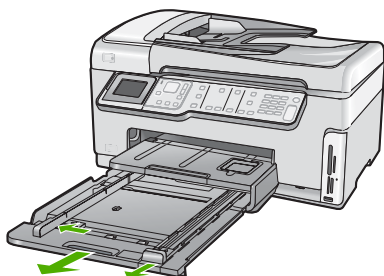

2. Tap a stack of paper on a flat surface to align the edges, and then check the paper for the following:
  - Make sure it is free of rips, dust, wrinkles, and curled or bent edges.
  - Make sure all the paper in the stack is the same size and type.

3. Insert the stack of paper into the main input tray with the short edge forward and the print side down. Slide the stack of paper forward until it stops.

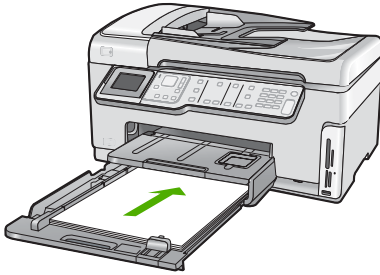

---

△ **CAUTION:** Make sure that the HP All-in-One is idle and silent when you load paper into the main input tray. If the HP All-in-One is servicing the ink cartridges or otherwise engaged in a task, the paper stop inside the device might not be in place. You could push the paper too far forward, causing the HP All-in-One to eject blank pages.

💡 **TIP:** If you are using letterhead, insert the top of the page first with the print side down. For more help on loading full-size paper and letterhead, refer to the diagram engraved in the base of the main input tray.

---

4. Slide the paper-width and paper-length guides inward until they stop at the edges of the paper.  
Do not overload the main input tray; make sure the stack of paper fits within the main input tray and is no higher than the top of the paper-width guide.

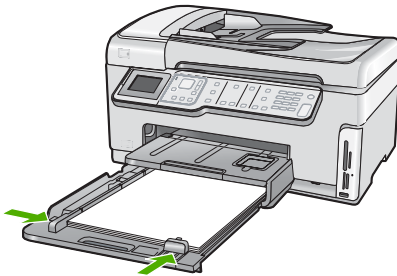

5. Push the main input tray back into the HP All-in-One.
6. Pull the output tray extender toward you, as far as it will go.

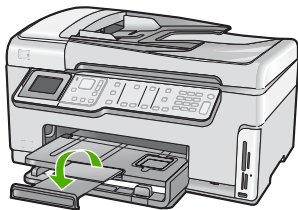

---

 **NOTE:** When you use legal-size paper, leave the tray extender closed.

---

### Related topics

- [“Recommended papers for printing and copying” on page 73](#)
- [“Change the print settings for the current job” on page 84](#)

## Load 10 x 15 cm (4 x 6 inch) photo paper

You can load up to 10 x 15 cm (4 x 6 inch) photo paper into the photo tray of the HP All-in-One. For the best results, use 10 x 15 cm (4 x 6 inch) HP Premium Plus Photo Paper or HP Premium Photo Paper.



### To load 10 x 15 cm (4 x 6 inch) photo paper in the photo tray

1. Raise the output tray, and then pull out the photo tray.

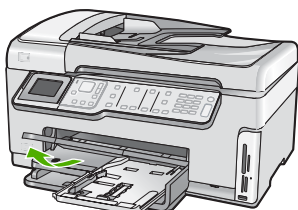

2. Insert the stack of photo paper into the photo tray with the short edge forward and the glossy side down. Slide the stack of photo paper forward until it stops.  
If the photo paper you are using has perforated tabs, load the photo paper so that the tabs are closest to you.

3. Slide the paper-length and paper-width guides inward against the stack of photo paper until the guides stop.  
Do not overload the photo tray; make sure the stack of photo paper fits within the photo tray and is no higher than the top of the paper-width guide.

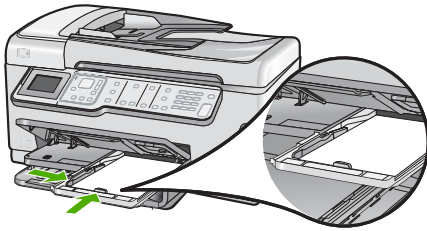

4. Push in the photo tray, and then lower the output tray.

#### Related topics

- [“Recommended papers for printing only”](#) on page 74
- [“Print your photos”](#) on page 104
- [“Print a borderless image”](#) on page 90
- [“Print a photo on photo paper”](#) on page 91

### Load postcards, Hagaki, or index cards

You can load postcards, Hagaki, and index cards in the photo tray.

For best results, set the paper type and paper size before copying or printing.

#### To load postcards, Hagaki or index cards in the photo tray

1. Raise the output tray, and then pull out the photo tray.

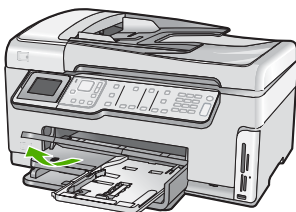

2. Insert the stack of cards into the photo tray with the short edge forward and the print side down. Slide the stack forward until it stops.



- Slide the paper-length and paper-width guides inward against the stack of cards until the guides stop.

Do not overload the photo tray; make sure the stack of cards fits within the photo tray and is no higher than the top of the paper-width guide.

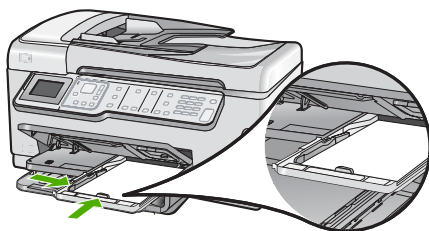

- Push in the photo tray, and then lower the output tray.

### Related topics

[“Change the print settings for the current job” on page 84](#)

## Load envelopes

You can load one or more envelopes into the main input tray of the HP All-in-One. Do not use shiny or embossed envelopes or envelopes that have clasps or windows.

 **NOTE:** For specific details on how to format text for printing on envelopes, consult the help files in your word processing software. For best results, consider using a label for the return address on envelopes.

### To load envelopes

- Pull out the main input tray to load envelopes.
- Remove all paper from the main input tray.
- Insert one or more envelopes into the far-right side of the main input tray, with the envelope flaps on the left and facing up. Slide the stack of envelopes forward until it stops.

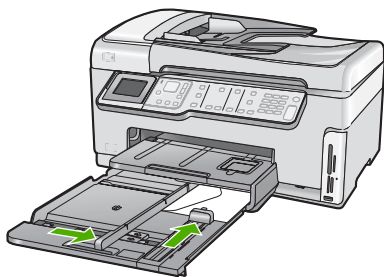

4. Slide the paper-width guide inward against the stack of envelopes until it stops. Do not overload the main input tray; make sure the stack of envelopes fits within the main input tray and is not higher than the top of the paper-width guide.
5. Push the main input tray back into the HP All-in-One.
6. Pull the output tray extender towards you, as far as it will go.

### Related topics

[“Change the print settings for the current job” on page 84](#)

## Load other types of paper

The following types of paper are designed for special projects. Create your project in the HP Photosmart Software or another application, set the paper type and size, and then print.

### HP Premium Inkjet Transparency Film and HP Premium Plus Inkjet Transparency Film

- ▲ Insert the film so that the white transparency strip (with arrows and the HP logo) is on top and is going into the input tray first.



**NOTE:** For best results, set the paper type to transparency film before printing on transparency film.

### HP Iron-On Transfers

1. Flatten the transfer sheet completely before using it; do not load curled sheets.



**TIP:** To prevent curling, keep transfer sheets sealed in the original package until you are ready to use them.

2. Locate the blue stripe on the nonprinting side of the transfer paper and then manually feed one sheet at a time into the input tray with the blue stripe facing up.

### HP Greeting Cards, HP Photo Greeting Cards, or HP Textured Greeting Cards

- ▲ Insert a small stack of HP greeting card paper into the input tray with the print side down; slide the stack of cards forward until it stops.



**TIP:** Make sure the area on which you want to print is inserted first, print side down in the input tray.

### Inkjet labels

1. Always use letter or A4 label sheets designed for use with inkjet devices, and make sure that the labels are no more than two years old. Labels on older sheets might peel off when the paper is pulled through the HP All-in-One, causing subsequent paper jams.
2. Fan the stack of labels to make sure none of the pages are sticking together.
3. Place a stack of label sheets on top of full-size plain paper in the input tray, label side down. Do not insert labels one sheet at a time.

For best results, set the paper type and paper size before printing.

### HP CD/DVD Tattoo labels

- ▲ Place one sheet of CD/DVD tattoo paper in the input tray with the print side down; slide the CD/DVD tattoo paper forward until it stops.



**NOTE:** When you use CD/DVD tattoo labels, leave the tray extender closed.

### Related topics

- [“Change the print settings for the current job”](#) on page 84
- [“Recommended papers for printing only”](#) on page 74

## Avoid paper jams

To help avoid paper jams, follow these guidelines.

- Remove printed papers from the output tray frequently.
- Do not leave originals on the glass. If you load an original in the automatic document feeder while there is already an original on the glass, the original can jam in the automatic document feeder.
- Prevent curled or wrinkled paper by storing all unused paper flat in a resealable bag.
- Ensure that paper loaded in the input tray lays flat and the edges are not bent or torn.
- If you are printing labels, ensure that the label sheets are no more than two years old. Labels on older sheets might peel off when the paper is pulled through the HP All-in-One, and cause paper jams.
- Do not combine different paper types and paper sizes in the input tray; the entire stack of paper in the input tray must be the same size and type.
- Adjust the paper-width guide in the input tray to fit snugly against all paper. Make sure the paper-width guide does not bend the paper in the input tray.
- Do not force paper too far forward in the input tray.
- Use paper types that are recommended for the HP All-in-One.

### Related topics

- [“Recommended papers for printing and copying”](#) on page 73
- [“Papers to avoid”](#) on page 75
- [“Clear paper jams”](#) on page 171

# 7 Print from your computer

The HP All-in-One can be used with any software application that allows printing. You can print a range of projects, such as borderless images, newsletters, greeting cards, iron-on transfers, and posters.

This section contains the following topics:

- [Print from a software application](#)
- [Make the HP All-in-One the default printer](#)
- [Change the print settings for the current job](#)
- [Change the default print settings](#)
- [Printing shortcuts](#)
- [Perform special print jobs](#)
- [Stop a print job](#)

## Print from a software application

Most print settings are automatically handled by the software application. You need to change the settings manually only when you change print quality, print on specific types of paper or transparency film, or use special features.

### To print from a software application

1. Make sure you have paper loaded in the input tray.
2. On the **File** menu in your software application, click **Print**.
3. Select the HP All-in-One as the printer.  
If you set the HP All-in-One as the default printer, you can skip this step. The HP All-in-One will already be selected.
4. If you need to change settings, click the button that opens the **Properties** dialog box. Depending on your software application, this button might be called **Properties**, **Options**, **Printer Setup**, **Printer**, or **Preferences**.



**NOTE:** When printing a photo, you must select options for the specific photo paper and photo enhancement.

---

5. Select the appropriate options for your print job by using the features available in the **Advanced**, **Printing Shortcuts**, **Features**, and **Color** tabs.



**TIP:** You can easily select the appropriate options for your print job by choosing one of the predefined print tasks on the **Printing Shortcuts** tab. Click a type of print task in the **Printing Shortcuts** list. The default settings for that type of print task are set and summarized on the **Printing Shortcuts** tab. If necessary, you can adjust the settings here and save your custom settings as a new printing shortcut. To save a custom printing shortcut, select the shortcut and click **Save As**. To delete a shortcut, select the shortcut and click **Delete**.

---

6. Click **OK** to close the **Properties** dialog box.
7. Click **Print** or **OK** to begin printing.

## Make the HP All-in-One the default printer

You can set the HP All-in-One as the default printer to use from all software applications. This means that the HP All-in-One is automatically selected in the printer list when you select **Print** from the **File** menu in a software application. The default printer is automatically selected when you click the **Print** button in the toolbar of most software applications. For more information, see the Windows Help.

## Change the print settings for the current job

You can customize the print settings of the HP All-in-One to handle nearly any print task.

This section contains the following topics:

- [Set the paper size](#)
- [Set the paper type for printing](#)
- [View the print resolution](#)
- [Change the print speed or quality](#)
- [Change the page orientation](#)
- [Scale the document size](#)
- [Change the saturation, brightness, or color tone](#)
- [Preview your print job](#)

### Set the paper size

The **Size** setting helps the HP All-in-One determine the printable area on the page. Some of the paper size choices have a borderless equivalent, which allows you to print to the top, bottom, and side edges of the paper.

Usually, you set the paper size in the software application you used to create your document or project. However, if you are using custom-size paper, or if you cannot set the paper size from your software application, you can change the paper size in the **Properties** dialog box before printing.

#### To set the paper size

1. Make sure you have paper loaded in the input tray.
2. On the **File** menu in your software application, click **Print**.
3. Make sure the HP All-in-One is the selected printer.
4. Click the button that opens the **Properties** dialog box. Depending on your software application, this button might be called **Properties**, **Options**, **Printer Setup**, **Printer**, or **Preferences**.
5. Click the **Features** tab.
6. In the **Resizing Options** area, click the appropriate paper size from the **Size** list. The following table lists the suggested paper size settings for the different types of paper you can load in the input tray. Make sure to look at the long list of choices in

the **Size** list to see if a defined paper size already exists for the type of paper you are using.

Paper type	Suggested paper size settings
CD/DVD tattoo paper	5 x 7 in.
Copier, multi-purpose, or plain papers	Letter or A4
Envelopes	Appropriate listed envelope size
Greeting-card papers	Letter or A4
Index cards	Appropriate listed card size (if listed sizes are not appropriate, you can specify a custom paper size)
Inkjet papers	Letter or A4
Iron-on T-shirt transfers	Letter or A4
Labels	Letter or A4
Legal	Legal
Letterhead	Letter or A4
Panorama photo paper	Appropriate listed panorama size (if listed sizes are not appropriate, you can specify a custom paper size)
Photo papers	10 x 15 cm. (with or without tab), 4 x 6 in. (with or without tab), letter, A4, or appropriate listed size
Transparency films	Letter or A4
Custom-size papers	Custom paper size

## Set the paper type for printing

If you print on special papers, such as photo paper, transparency film, envelopes, or labels, or if you experience poor print quality, you can set the paper type manually.

### To set the paper type for printing

1. Make sure you have paper loaded in the input tray.
2. On the **File** menu in your software application, click **Print**.
3. Make sure the HP All-in-One is the selected printer.
4. Click the button that opens the **Properties** dialog box. Depending on your software application, this button might be called **Properties**, **Options**, **Printer Setup**, **Printer**, or **Preferences**.
5. Click the **Features** tab.
6. In the **Basic Options** area, click the appropriate paper type from the **Paper Type** list.

## View the print resolution

The printer software displays the print resolution in dots per inch (dpi). The dpi varies according to the paper type and print quality that you select in the printer software.

**To view the print resolution**

1. Make sure you have paper loaded in the input tray.
2. On the **File** menu in your software application, click **Print**.
3. Make sure the HP All-in-One is the selected printer.
4. Click the button that opens the **Properties** dialog box.  
Depending on your software application, this button might be called **Properties**, **Options**, **Printer Setup**, **Printer**, or **Preferences**.
5. Click the **Features** tab.
6. In the **Print Quality** drop-down list, select the appropriate print quality setting for your project.
7. In the **Paper Type** drop-down list, select the type of paper that you have loaded.
8. Click the **Resolution** button to view the print resolution dpi.

**Change the print speed or quality**

The HP All-in-One automatically chooses a print quality and speed setting depending on the paper type setting you select. You can also change the print quality setting to customize the speed and quality of the print process.

**To select a print speed or quality**

1. Make sure you have paper loaded in the input tray.
2. On the **File** menu in your software application, click **Print**.
3. Make sure the HP All-in-One is the selected printer.
4. Click the button that opens the **Properties** dialog box.  
Depending on your software application, this button might be called **Properties**, **Options**, **Printer Setup**, **Printer**, or **Preferences**.
5. Click the **Features** tab.
6. In the **Print Quality** drop-down list, select the appropriate quality setting for your project.



**NOTE:** To view the maximum dpi that the HP All-in-One will print, click **Resolution**.

---

7. In the **Paper Type** drop-down list, select the type of paper that you have loaded.

**Change the page orientation**

The page orientation setting allows you to print your document vertically or horizontally on the page.

Usually, you set the page orientation in the software application you used to create your document or project. However, if you are using custom-size or special HP paper, or if you cannot set the page orientation from your software application, you can change the page orientation in the **Properties** dialog box before printing.

**To change the page orientation**

1. Make sure you have paper loaded in the input tray.
2. On the **File** menu in your software application, click **Print**.

3. Make sure the HP All-in-One is the selected printer.
4. Click the button that opens the **Properties** dialog box.  
Depending on your software application, this button might be called **Properties**, **Options**, **Printer Setup**, **Printer**, or **Preferences**.
5. Click the **Features** tab.
6. In the **Basic Options** area, click one of the following:
  - Click **Portrait** to print the document vertically on the page.
  - Click **Landscape** to print the document horizontally on the page.

## Scale the document size

The HP All-in-One allows you to print the document at a different size than the original.

### To scale the document size

1. Make sure you have paper loaded in the input tray.
2. On the **File** menu in your software application, click **Print**.
3. Make sure the HP All-in-One is the selected printer.
4. Click the button that opens the **Properties** dialog box.  
Depending on your software application, this button might be called **Properties**, **Options**, **Printer Setup**, **Printer**, or **Preferences**.
5. Click the **Features** tab.
6. In the **Resizing options** area, click **Scale to paper size**, and then click the appropriate paper size from the drop-down list.

## Change the saturation, brightness, or color tone

You can change the intensity of colors and the level of darkness in your printout by adjusting the **Saturation**, **Brightness**, or **Color Tone** options.

### To change the saturation, brightness, or color tone

1. Make sure you have paper loaded in the input tray.
2. On the **File** menu in your software application, click **Print**.
3. Make sure the HP All-in-One is the selected printer.
4. Click the button that opens the **Properties** dialog box.  
Depending on your software application, this button might be called **Properties**, **Options**, **Printer Setup**, **Printer**, or **Preferences**.
5. Click the **Color** tab.

## Preview your print job

You can preview your print job before sending it to the HP All-in-One. This helps to prevent wasting paper and ink on projects that do not print as expected.

### To preview your print job

1. Make sure you have paper loaded in the input tray.
2. On the **File** menu in your software application, click **Print**.
3. Make sure the HP All-in-One is the selected printer.



4. Click the button that opens the **Properties** dialog box. Depending on your software application, this button might be called **Properties**, **Options**, **Printer Setup**, **Printer**, or **Preferences**.
5. Select the print settings appropriate for your project on each of the tabs in the dialog box.
6. Click the **Features** tab.
7. Select the **Show Preview Before Printing** check box.
8. Click **OK**, and then click **Print** or **OK** in the **Print** dialog box. Your print job displays in the preview window.
9. In the **HP preview** window, do one of the following:
  - To print, click **Start Printing**.
  - To cancel, click **Cancel Printing**.

## Change the default print settings

If there are settings that you frequently use for printing, you might want to make them the default print settings so they are already set when you open the **Print** dialog box from within your software application.

### To change the default print settings

1. In the HP Solution Center, click **Settings**, point to **Print Settings**, and then click **Printer Settings**.
2. Make changes to the print settings, and click **OK**.

## Printing shortcuts

Use printing shortcuts to print with print settings that you use often. The printer software has several specially designed printing shortcuts that are available in the Printing Shortcuts list.

---

 **NOTE:** When you select a printing shortcut the appropriate printing options are automatically displayed. You can leave them as is, change them, or create your own shortcuts for commonly used tasks.

---

Use the Printing Shortcuts tab for the following print tasks:

- **General Everyday Printing:** Print documents quickly.
- **Photo Printing–Borderless:** Print to the top, bottom, and side edges of 10 x 15 cm (4 x 6 inch) HP Photo Papers with or without a tear-off tab.
- **Photo Printing–With White Borders:** Print a photo with a white border around the edges.
- **Fast/Economical printing:** Produce draft-quality printouts quickly.
- **Presentation printing:** Print high-quality documents, including letters and transparencies.
- **Two-sided (Duplex) Printing:** Print two-sided pages with the HP All-in-One.

This section contains the following topics:

- [Create printing shortcuts](#)
- [Delete printing shortcuts](#)

### Related topics

- [“Print a borderless image” on page 90](#)
- [“Print a photo on photo paper” on page 91](#)
- [“Print on transparencies” on page 96](#)
- [“Print on both sides of the page” on page 93](#)

## Create printing shortcuts

In addition to the printing shortcuts that are available in the **Printing Shortcuts** list, you can create your own printing shortcuts.

If you frequently print on transparency film, for example, you can create a printing shortcut by selecting the **Presentation Printing** shortcut, changing the paper type to **HP Premium Inkjet Transparency Film**, and then saving the modified shortcut under a new name; for example, **Transparency Presentations**. After creating the printing shortcut, simply select it when printing on transparency film rather than changing the print settings each time.

### To create a printing shortcut

1. On the **File** menu in your software application, click **Print**.
2. Make sure the HP All-in-One is the selected printer.
3. Click the button that opens the **Properties** dialog box.  
Depending on your software application, this button might be called **Properties**, **Options**, **Printer Setup**, **Printer**, or **Preferences**.
4. Click the **Printing Shortcuts** tab.
5. In the **Printing Shortcuts** list, click a printing shortcut.  
The print settings for the selected printing shortcut are displayed.
6. Change the print settings to those you want in the new printing shortcut.
7. In the **Type new shortcut name here** box, type a name for the new printing shortcut, and then click **Save**.  
The printing shortcut is added to the list.

## Delete printing shortcuts

You might want to delete printing shortcuts that you no longer use.

### To delete a printing shortcut

1. On the **File** menu in your software application, click **Print**.
2. Make sure the HP All-in-One is the selected printer.
3. Click the button that opens the **Properties** dialog box.  
Depending on your software application, this button might be called **Properties**, **Options**, **Printer Setup**, **Printer**, or **Preferences**.
4. Click the **Printing Shortcuts** tab.

5. In the **Printing Shortcuts** list, click the printing shortcut that you want to delete.
6. Click **Delete**.  
The printing shortcut is removed from the list.



**NOTE:** Only the shortcuts that you have created can be deleted. The original HP shortcuts cannot be deleted.

## Perform special print jobs

In addition to supporting standard print jobs, the HP All-in-One can perform special jobs such as printing borderless images, iron-on transfers, and posters.

This section contains the following topics:

- [Print a borderless image](#)
- [Print a photo on photo paper](#)
- [Print custom CD/DVD labels](#)
- [Print using Maximum dpi](#)
- [Print on both sides of the page](#)
- [Print a multiple-page document as a booklet](#)
- [Print multiple pages on a single sheet](#)
- [Print a multiple-page document in reverse order](#)
- [Reverse an image for iron-on transfers](#)
- [Print on transparencies](#)
- [Print a group of addresses on labels or envelopes](#)
- [Print a poster](#)
- [Print a Web page](#)

### Print a borderless image

Borderless printing lets you print to the top, bottom, and side edges of 10 x 15 cm (4 x 6 inch) photo paper.



**TIP:** For the best results, use HP Premium Photo Papers or HP Premium Plus Photo Papers to print your photos.

#### To print a borderless image

1. Load up to 10 x 15 cm (4 x 6 inch) paper in the photo tray or full-size photo paper in the main input tray.
2. On the **File** menu in your software application, click **Print**.
3. Make sure the HP All-in-One is the selected printer.
4. Click the button that opens the **Properties** dialog box.  
Depending on your software application, this button might be called **Properties**, **Options**, **Printer Setup**, **Printer**, or **Preferences**.
5. Click the **Features** tab.

6. In the **Size** list, click the size of photo paper loaded in the photo tray.  
If a borderless image can be printed on the specified size, the **Borderless printing** check box is enabled.
7. In the **Paper Type** drop-down list, click **More**, and then select the appropriate paper type.



---

**NOTE:** You cannot print a borderless image if the paper type is set to **Plain paper** or to a type of paper other than a photo paper.

---

8. Select the **Borderless printing** check box if it is not already checked.  
If the borderless paper size and paper type are not compatible, the HP All-in-One software displays an alert and allows you to select a different type or size.
9. Click **OK**, and then click **Print** or **OK** in the **Print** dialog box.

## Print a photo on photo paper

For high-quality photo printing, HP recommends you use HP Premium Plus Photo Papers with the HP All-in-One.

### To print a photo on photo paper

1. Remove all paper from the input tray, and then load the photo paper print side down.
2. On the **File** menu in your software application, click **Print**.
3. Make sure the HP All-in-One is the selected printer.
4. Click the button that opens the **Properties** dialog box.  
Depending on your software application, this button might be called **Properties**, **Options**, **Printer Setup**, **Printer**, or **Preferences**.
5. Click the **Features** tab.
6. In the **Basic Options** area, select the appropriate photo paper type from the **Paper Type** drop-down list.
7. In the **Resizing Options** area, click the appropriate paper size from the **Size** list.  
If the paper size and paper type are not compatible, the HP All-in-One software displays an alert and allows you to select a different type or size.
8. In the **Basic Options** area, select a high print quality, such as **Best** or **Maximum dpi** from the **Print Quality** drop-down list.
9. In the **HP Real Life technologies** area, click the **Photo fix** drop-down list and select from the following options:
  - **Off:** applies no **HP Real Life technologies** to the image.
  - **Basic:** automatically focuses the image; moderately adjusts image sharpness.
  - **Full:** automatically lightens dark images; automatically adjusts sharpness, contrast, and focus of images; automatically removes red-eye.
10. Click **OK** to return to the **Properties** dialog box.
11. If you want to print the photo in black and white, click the **Color** tab and select the **Print in grayscale** check box.
12. Click **OK**, and then click **Print** or **OK** in the **Print** dialog box.



**NOTE:** Do not leave unused photo paper in the input tray. The paper might start to curl, which could reduce the quality of your printout. Photo paper should be flat before printing.

## Print custom CD/DVD labels

You can use the HP Photosmart Software or online templates from the HP Web site to create and print a custom label on CD/DVD tattoo paper. You can affix the printed CD/DVD tattoo to any CD/DVD.

### To print a CD/DVD tattoo

1. Use the HP Photosmart Software, or go to [www.hp.com](http://www.hp.com) to access templates for creating CD/DVD labels.
2. Load 13 x 18 cm (5 x 7 inch) CD/DVD tattoo paper in the main input tray.
3. On the **File** menu in your software application, click **Print**.
4. Make sure the HP All-in-One is the selected printer.
5. Click the button that opens the **Properties** dialog box.  
Depending on your software application, this button might be called **Properties**, **Options**, **Printer Setup**, **Printer**, or **Preferences**.
6. Click the **Features** tab.
7. In the **Paper Type** drop-down list, click **More**, and then select **HP CD/DVD tattoo paper** from the list.
8. Click **OK**, and then click **Print** or **OK** in the **Print** dialog box.

## Print using Maximum dpi

Use **Maximum dpi** mode to print high-quality, sharp images.

To get the most benefit from **Maximum dpi** mode, use it to print high-quality images such as digital photographs. When you select the **Maximum dpi** setting, the printer software displays the optimized dots per inch (dpi) that the HP All-in-One will print.

Printing in **Maximum dpi** takes longer than printing with other settings and requires a large amount of disk space.

### To print in Maximum dpi mode

1. Make sure you have paper loaded in the input tray.
2. On the **File** menu in your software application, click **Print**.
3. Make sure the HP All-in-One is the selected printer.
4. Click the button that opens the **Properties** dialog box.  
Depending on your software application, this button might be called **Properties**, **Options**, **Printer Setup**, **Printer**, or **Preferences**.
5. Click the **Features** tab.
6. In the **Paper Type** drop-down list, click **More**, and then select the appropriate paper type.

7. In the **Print Quality** drop-down list, click **Maximum dpi**.



**NOTE:** To view the maximum dpi that the HP All-in-One will print, click **Resolution**.

8. Select any other print settings that you want, and then click **OK**.

## Print on both sides of the page

You can print two-sided pages with the HP All-in-One. When printing two-sided pages, make sure to use paper that is thick enough so that images do not show through to the other side.

### To print on both sides of the page

1. Load paper into the input tray.
2. On the **File** menu in your software application, click **Print**.
3. Make sure the HP All-in-One is the selected printer.
4. Click the button that opens the **Properties** dialog box.  
Depending on your software application, this button might be called **Properties**, **Options**, **Printer Setup**, **Printer**, or **Preferences**.
5. Click the **Features** tab.
6. In the **Paper saving options** area, select **Two-sided printing**.
7. Click **OK**, and then click **Print** or **OK** in the **Print** dialog box.

### Related topics

[“Recommended papers for printing and copying” on page 73](#)

## Print a multiple-page document as a booklet

The HP All-in-One allows you to print your document as a small booklet, which you can fold and then staple together.

For best results, design your document to fit on a multiple of four pages, such as an 8, 12, or 16-page program for a child's school play or for a wedding.

### To print a multiple-page document as a booklet

1. Load paper into the input tray.  
The paper should be thick enough so that the images do not show through to the other side.
2. On the **File** menu in your software application, click **Print**.
3. Make sure the HP All-in-One is the selected printer.
4. Click the button that opens the **Properties** dialog box.  
Depending on your software application, this button might be called **Properties**, **Options**, **Printer Setup**, **Printer**, or **Preferences**.
5. Click the **Features** tab.
6. In the **Paper saving options** area, select **Two-sided printing**.

7. Select the binding edge from the **Booklet layout is** list, as appropriate for your language.
  - If your language reads left-to-right, click **Left edge binding**.
  - If your language reads right-to-left, click **Right edge binding**.

The **Pages per sheet** box is automatically set to two pages per sheet.

8. Click **OK**, and then click **Print** or **OK** in the **Print** dialog box.  
The HP All-in-One begins printing.
9. Wait until the HP All-in-One has stopped printing for several seconds before removing any of the printed pages from the output tray.  
If you remove the pages while the document is still printing, the pages might get out of order.
10. When the entire document has finished printing, fold the stack of paper in half, so that the first page is on top, then staple the document along the crease.

---

 **TIP:** For best results, use a saddle stapler, or a heavy-duty stapler with a long reach to staple the booklet.

---

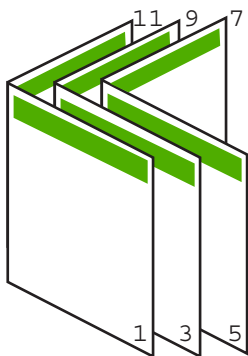

**Figure 7-1** Left-edge binding for left-to-right languages

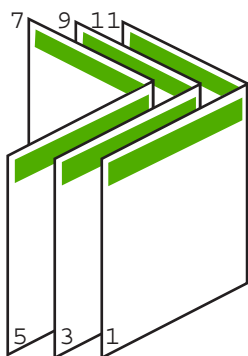

**Figure 7-2** Right-edge binding for right-to-left languages

## Print multiple pages on a single sheet

You can print up to 16 pages on a single sheet of paper.

### To print multiple pages on a single sheet

1. Make sure you have paper loaded in the input tray.
2. On the **File** menu in your software application, click **Print**.
3. Make sure the HP All-in-One is the selected printer.
4. Click the button that opens the **Properties** dialog box.  
Depending on your software application, this button might be called **Properties**, **Options**, **Printer Setup**, **Printer**, or **Preferences**.
5. Click the **Features** tab.
6. In the **Pages per sheet** list, click **2**, **4**, **6**, **8**, **9**, or **16**.
7. If you want a border to appear around each page image printed on the sheet of paper, select the **Print page borders** check box.
8. In the **Page order** list, click an appropriate page order option.  
The sample output graphic is numbered to show how the pages will be ordered if you select each option.
9. Click **OK**, and then click **Print** or **OK** in the **Print** dialog box.

## Print a multiple-page document in reverse order

Because of the way the paper feeds through the HP All-in-One, the first page that prints is print side up at the bottom of the stack. Usually this means you need to put the printed pages in the correct order.

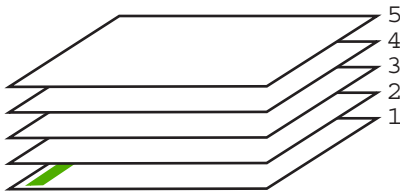

A better way is to print the document in reverse order so that the pages are stacked correctly.

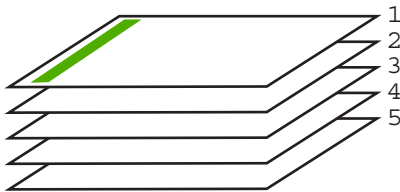

 **TIP:** Set this option as a default setting so you do not have to remember to set it every time you print a multiple-page document.



**To print a multiple-page document in reverse order**

1. Make sure you have paper loaded in the input tray.
2. On the **File** menu in your software application, click **Print**.
3. Make sure the HP All-in-One is the selected printer.
4. Click the button that opens the **Properties** dialog box.  
Depending on your software application, this button might be called **Properties**, **Options**, **Printer Setup**, **Printer**, or **Preferences**.
5. Click the **Advanced** tab.
6. In the **Layout Options** area, select **Front to Back** in the **Page Order** option.



**NOTE:** If you set your document to print on both sides of the page, the **Front to Back** option is not available. Your document will automatically print in the correct order.

7. Click **OK**, and then click **Print** or **OK** in the **Print** dialog box.



**NOTE:** When you are printing multiple copies, each set is printed completely before the next set is printed.

**Reverse an image for iron-on transfers**

This feature reverses an image so you can use it for iron-on transfers. This feature is also useful for transparencies when you want to make notations on the back of the transparency without scratching the original.

**To reverse an image for iron-on transfers**

1. On the **File** menu in your software application, click **Print**.
2. Make sure the HP All-in-One is the selected printer.
3. Click the button that opens the **Properties** dialog box.  
Depending on your software application, this button might be called **Properties**, **Options**, **Printer Setup**, **Printer**, or **Preferences**.
4. Click the **Features** tab.
5. In the **Paper Type** drop-down list, click **More**, and then select **HP Iron-on Transfer** from the list.
6. If the selected size is not what you want, click an appropriate size in the **Size** list.
7. Click the **Advanced** tab.
8. In the **Printer Features** area, select **On** from the **Mirror Image** drop-down list.
9. Click **OK**, and then click **Print** or **OK** in the **Print** dialog box.



**NOTE:** To prevent jams, manually feed the iron-on transfer sheets into the input tray one sheet at a time.

**Print on transparencies**

For the best results, HP recommends you use HP transparency products with the HP All-in-One.

### To print on transparencies

1. Load the transparency into the input tray.
2. On the **File** menu in your software application, click **Print**.
3. Make sure the HP All-in-One is the selected printer.
4. Click the button that opens the **Properties** dialog box.  
Depending on your software application, this button might be called **Properties**, **Options**, **Printer Setup**, **Printer**, or **Preferences**.
5. Click the **Features** tab.
6. In the **Paper Type** drop-down list, click **More**, and then select the appropriate paper type.

---

 **TIP:** If you want to make notations on the back of the transparencies and erase them later without scratching the original, click the **Advanced** tab, and select the **Mirror Image** check box.

---

7. In the **Resizing Options** area, click an appropriate size in the **Size** list.
8. Click **OK**, and then click **Print** or **OK** in the **Print** dialog box.

---

 **NOTE:** The HP All-in-One automatically waits for transparencies to dry before releasing them. Ink dries slower on film than on plain paper. Make sure you allow enough time for the ink to dry before handling the transparency.

---

## Print a group of addresses on labels or envelopes

With the HP All-in-One, you can print on a single envelope, a group of envelopes, or label sheets designed for inkjet printers.

### To print a group of addresses on labels or envelopes

1. Print a test page on plain paper first.
2. Place the test page on top of the label sheet or envelope, and hold both up to the light. Check the spacing for each block of text. Make adjustments as needed.
3. Load the labels or envelopes into the main input tray.

---

 **CAUTION:** Do not use envelopes with clasps or windows. They can get stuck in the rollers and cause paper jams.

---

4. Slide the paper-length and paper-width guides inward against the stack of labels or envelopes until the guides stop.
5. If you are printing on envelopes, do the following:
  - a. Display the print settings, and click the **Features** tab.
  - b. In the **Resizing Options** area, click the appropriate envelope size in the **Size** list.
6. Click **OK**, and then click **Print** or **OK** in the **Print** dialog box.

## Print a poster

You can create a poster by printing a document on multiple pages. The HP All-in-One prints dotted lines on some pages to indicate where to trim the pages before taping them together.

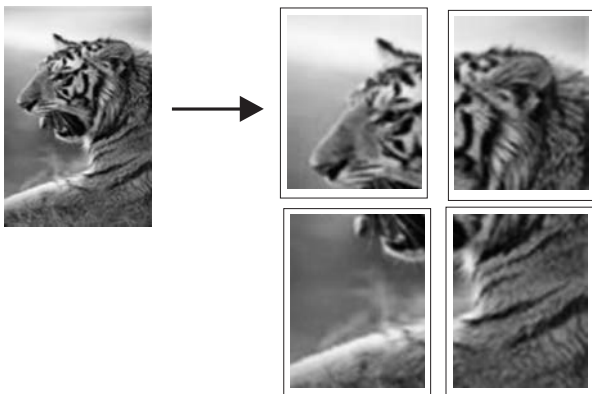

### To print a poster

1. Make sure you have paper loaded in the input tray.
2. On the **File** menu in your software application, click **Print**.
3. Make sure the HP All-in-One is the selected printer.
4. Click the button that opens the **Properties** dialog box.  
Depending on your software application, this button might be called **Properties**, **Options**, **Printer Setup**, **Printer**, or **Preferences**.
5. Click the **Advanced** tab.
6. Expand **Document Options**, and then expand **Printer Features**.
7. In the **Poster Printing** drop-down list, click either **2x2 (4 sheets)**, **3x3 (9 sheets)**, **4x4 (16 sheets)**, or **5x5 (25 sheets)**.  
This selection tells the HP All-in-One to enlarge your document so that it fits on 4, 9, 16, or 25 pages.  
If your originals are of multiple pages, each of those pages will be printed on 4, 9, 16, or 25 pages. For example, if you have a one-page original and you select 3x3, you will get 9 pages; if you select 3x3 for a two-page original, 18 pages will print.
8. Click **OK**, and then click **Print** or **OK** in the **Print** dialog box.
9. After the poster has printed, trim the edges of the sheets and tape the sheets together.

## Print a Web page

You can print a Web page from your Web browser on the HP All-in-One.

### To print a Web page

1. Make sure you have paper loaded in the main input tray.
2. On the **File** menu in your Web browser, click **Print**.  
The **Print** dialog box appears.

3. Make sure the HP All-in-One is the selected printer.
4. If your Web browser supports it, select the items on the Web page that you want to include in the printout.  
For example, in Internet Explorer, click the **Options** tab to select options such as **As laid out on screen**, **Only the selected frame**, and **Print all linked documents**.
5. Click **Print** or **OK** to print the Web page.

---

 **TIP:** To print Web pages correctly, you might need to set your print orientation to **Landscape**.

---

## Stop a print job

Although you can stop a print job from either the HP All-in-One or the computer, HP recommends you stop it from the HP All-in-One for best results.

---

 **NOTE:** Although most software applications designed for Windows use the Windows print spooler, your software application might not use the spooler. An example of a software application that does not use the Windows print spooler is PowerPoint in Microsoft Office 97.

If you cannot cancel your print job by using one of the following procedures, consult the instructions for canceling background printing in the online help for your software application.

---

### To stop a print job from the HP All-in-One

- ▲ Press **Cancel** on the control panel. If the print job does not stop, press **Cancel** again. It can take a few moments for the print job to be cancelled.

### To stop a print job from the computer (Windows 2000 users)

1. On the Windows taskbar, click **Start**, point to **Settings**, and then click **Printers**.
2. Double-click the HP All-in-One icon.

---

 **TIP:** You can also double-click the printer icon in the Windows taskbar.

---

3. Select the print job you want to cancel.
4. On the **Document** menu, click **Cancel Printing** or **Cancel**, or press the **Delete** key on your keyboard.  
It can take a few moments for the print job to be cancelled.

### To stop a print job from the computer (Windows XP users)

1. On the Windows taskbar, click **Start**, and then click **Control Panel**.
2. Open the **Printers and Faxes** control panel.
3. Double-click the HP All-in-One icon.

---

 **TIP:** You can also double-click the printer icon in the Windows taskbar.

---

4. Select the print job you want to cancel.
5. On the **Document** menu, click **Cancel Printing** or **Cancel**, or press the **Delete** key on your keyboard.  
It can take a few moments for the print job to be cancelled.

**To stop a print job from the computer (Windows Vista users)**

1. On the Windows taskbar, click **Start**, and then click **Control Panel**.
2. Click **Printers**.
3. Double-click the HP All-in-One icon.

---

 **TIP:** You can also double-click the printer icon in the Windows taskbar.

---

4. Select the print job you want to cancel.
5. On the **Document** menu, click **Cancel Printing** or **Cancel**, or press the **Delete** key on your keyboard.  
It can take a few moments for the print job to be cancelled.

## 8 Use the photo features

The HP All-in-One is equipped with memory card slots and a front USB port that enable you to print or edit photos from a memory card or storage device (such as a keychain drive, portable hard drive, or a digital camera in storage mode) without uploading your photos to a computer first. Additionally, if the HP All-in-One is network-connected or connected to a computer with a USB cable, you can also transfer your photos to the computer to print, edit, or share.

The HP All-in-One supports the memory cards described below. Each type of memory card can only be inserted in the appropriate slot for that card, and only one card may be inserted at a time.

△ **CAUTION:** Do not insert more than one memory card at a time. If more than one memory card is inserted, unrecoverable data loss might occur.

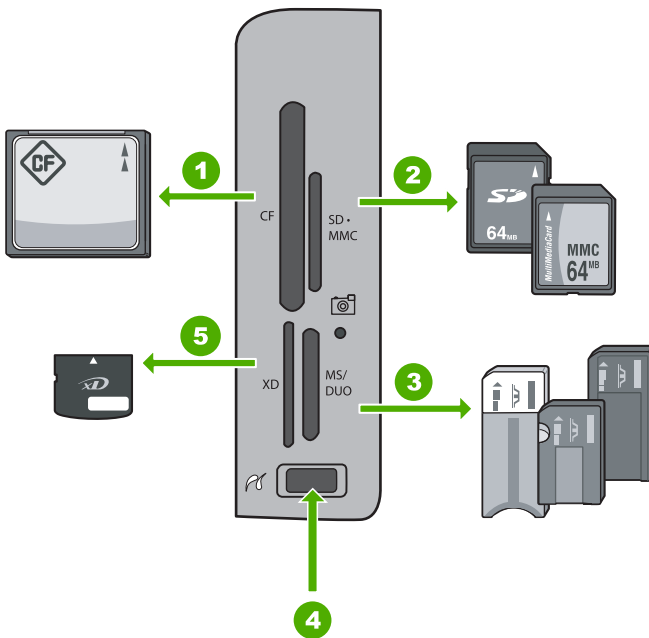

1	CompactFlash (CF) types I and II
2	Secure Digital (SD), Secure Digital Mini (adapter required), Secure Digital High Capacity (SDHC), MultiMediaCard (MMC), MMC Plus, MMC Mobile (RS-MMC; adapter required), TransFlash MicroSD Card, or Secure MultiMedia Card
3	Memory Stick, Memory Stick Pro, Memory Stick Select, Memory Stick Magic Gate, Memory Stick Duo or Duo Pro (adapter optional), or Memory Stick Micro (adapter required)
4	Front USB port (for storage devices)
5	xD-Picture Card

The memory card area also has a Photo light. This light blinks green when a memory card is being read or when an image is being printed from a card, and stays solid green when images are ready to be viewed. The Photo light is located near the memory card slots and is indicated by a camera icon.

---

△ **CAUTION:** Do not pull out the memory card or storage device while the Photo light is flashing. A flashing light means the HP All-in-One is accessing the memory device. Wait until the light remains solid. Removing a memory card or storage device while it is being accessed might corrupt information on the memory device or damage the HP All-in-One, memory card, or storage device.

---

This section contains the following topics:

- [View and select photos](#)
- [Print your photos](#)
- [Create special projects from your photos](#)
- [Share photos using HP Photosmart Software](#)
- [Save photos to your computer](#)
- [Edit photos using the control panel](#)

## View and select photos

You can view and select photos on your memory card or storage device before or while printing them.

## To view and select photos

1. Insert a memory card into the appropriate slot on the HP All-in-One, or connect a storage device to the front USB port.  
The **Photosmart Express** menu appears, with the most recent photo shown on the display.



### View

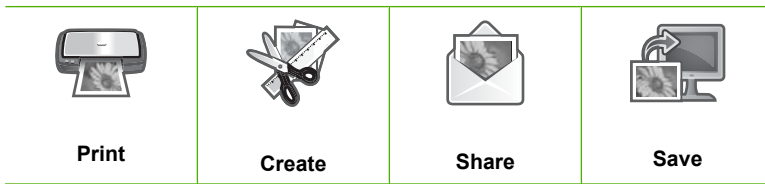

2. Load up to 10 x 15 cm (4 x 6 inch) photo paper in the photo tray or full-size photo paper in the main input tray.
3. With **View** highlighted, press **OK**.  
The **View Photos** screen appears.
4. Press ◀ or ▶ to scroll through the thumbnails of your photos.
5. When the thumbnail of the photo you want to view is highlighted, press **OK**.
6. When the photo appears by itself on the display, press **OK** again.  
The **Photo Options** screen appears.
7. With **Print Preview** highlighted, press **OK**.  
The **Print Preview** screen appears, showing how your photo will look when printed.
8. If you want to select additional photos to view and print, press ▼ to highlight **Add More**, press **OK**, and repeat steps 4–6.  
Or, once you're in the **Add Photos** screen, the quickest way to select multiple photos (if you don't need the option to edit them) is to press ▲ to select a photo, and then press ◀ or ▶ to scroll through more photos to select.

**TIP:** A checkmark appears to indicate each photo that is selected. You can change the number of copies by pressing ▲ or ▼. The total number of photos that will print appears at the top of the display.



9. (Optional) If you want to check and/or modify any of your print settings, press ▼ to highlight **Settings** and press **OK**.
10. To print the photo(s), use ▲ or ▼ to highlight **Print Now** and press **OK** (or press **Print Photos** on the control panel).

A print status screen displays the number of pages to print and the estimated time to complete.

---

💡 **TIP:** During printing, you can highlight **Add more photos** and press **OK** to add more photos to the print queue.

---

## Print your photos

You can print the photos on your memory card or storage device in a variety of sizes, from 10 x 15 cm (4 x 6 inch) up to the size of letter or A4 paper, including multiple small-size photos on a single page.

---

### To print your photos

💡 **TIP:** If you want to print only a single borderless 10 x 15 cm (4 x 6 inch) photo on 10 x 15 cm (4 x 6 inch) paper, a shortcut is to simply press **Print Photos** twice on the control panel (once to display the **Print Preview** screen and once to start the print job).

1. Insert a memory card into the appropriate slot on the HP All-in-One, or attach a storage device to the front USB port.  
The **Photosmart Express** menu appears, with the most recent photo shown on the display.



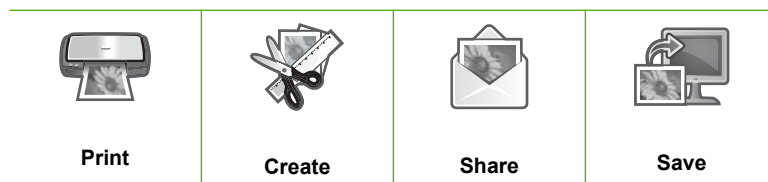

---

#### View

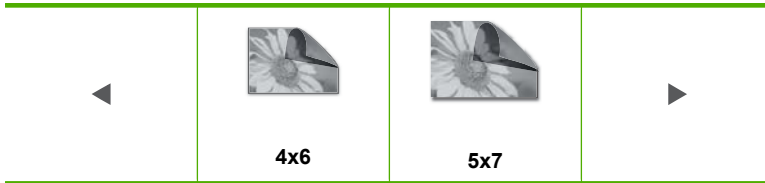

2. Load up to 10 x 15 cm (4 x 6 inch) paper in the photo tray or full-size photo paper in the main tray.
3. Press ► until **Print** is highlighted, and then press **OK**.  
The **Layout** screen appears.
4. Press ◀ or ▶ to scroll through the layout options, and press **OK** when the option you want is highlighted:



The **Select Photos** screen appears.

5. Press ◀ or ▶ to scroll through the thumbnails of the photos.
6. When you have highlighted the thumbnail of the photo you want to print, press **OK**.
7. When the chosen photo appears by itself on the display, press ▲ to select it.  
A checkmark appears to indicate that the photo is selected. You can change the number of copies by pressing ▲ or ▼. The total number of photos that will print appears at the top of the display.
8. Press ◀ or ▶ to continue scrolling through and selecting photos, and then press **OK**.  
The **Photo Options** menu appears.
9. With **Print Preview** highlighted, press **OK**.  
The **Print Preview** screen appears, showing how your photo(s) will look when printed.
10. (Optional) If you want to check and/or modify any of your print settings, use ▲ or ▼ to highlight **Settings** and press **OK**.
11. Use ▲ or ▼ to highlight **Print Now** and press **OK** (or press **Print Photos** on the control panel).  
A print status screen displays the number of pages to print and the estimated time to complete.

## Create special projects from your photos

The HP All-in-One enables you to create special projects from your photos, including:

- Photo albums
- Panorama prints
- Wallet-size photos
- Passport-size photos

### To create special projects

1. Insert a memory card into the appropriate slot on the HP All-in-One, or connect a storage device to the front USB port.

The **Photosmart Express** menu appears, with the most recent photo shown on the display.



#### View



2. Make sure the photo tray or main input tray is loaded with the correct paper for the type of project you are creating.
3. Press ◀ or ▶ to highlight **Create**, and then press **OK**.  
The **Create** screen appears.
4. Press ◀ or ▶ to scroll through the projects, and then press **OK** to select the project you want:
  - **Album Pages:** Enables you to select multiple photos and print them onto a series of themed album pages, which you can then bind to create a photo album. The photos in your album pages are placed in the same orientation for a visually pleasing presentation.
  - **Panorama Prints:** Enables you to select multiple photos to "stitch" together to create a single wide view (or panorama) photo. The HP All-in-One automatically aligns the edges of the photos you select to create the smoothest transition from one photo to the next.
  - **Wallets:** Enables you to print your own wallet-size photos to carry with you or give to friends or relatives.
  - **Passport Photos:** Enables you to print your own passport-size photos. (If you have questions on guidelines or restrictions for passport photos, contact a local passport service agency.)

5. Respond to the prompts for the project you are creating.
6. At the **Print Preview** screen, highlight **Print Now**, and then press **OK**.  
A print status screen displays the number of pages to print and the estimated time to complete.

## Share photos using HP Photosmart Software

You can use the HP Photosmart Software installed on your computer to transfer photos from a memory card or storage device to your computer's hard drive for sharing photos online and printing from your computer.

Before transferring photos to your computer, you need to remove the memory card from your digital camera and insert it in the appropriate memory card slot on the HP All-in-One, or connect a storage device to the front USB port.

### To send photos from a memory card or storage device

1. Insert a memory card into the appropriate slot on the HP All-in-One, or connect a storage device to the front USB port.  
The **Photosmart Express** menu appears, with the most recent photo shown on the display.



#### View

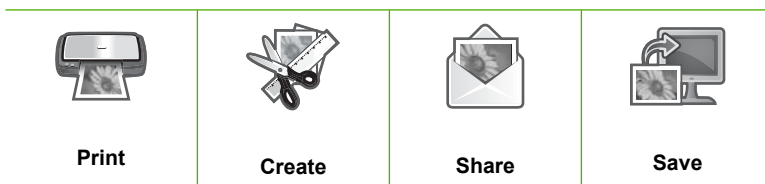

2. Press **▶** until **Share** is highlighted, and then press **OK**.  
The **Share Photos** screen appears.
3. Press **◀** or **▶** to scroll through the thumbnails of your photos.
4. When you have highlighted the thumbnail of the photo you want to share, press **OK**.
5. When the chosen photo appears by itself on the display, press **▲** to select it.  
A checkmark appears to indicate that the photo is selected.

6. Press ◀ or ▶ to continue scrolling through and selecting photos, and then press **OK**.  
The **Share Options** screen appears.
7. Press ▲ or ▼ to highlight **Share**, and then press **OK**.  
If the HP All-in-One is network-connected, a list of available computers appears. Select the computer you want to use to send the photos, and then continue to the next step.
8. When the **Share Not Finished** message appears, press **OK** and then follow the onscreen prompts on your computer.

## Save photos to your computer

You can use the HP Photosmart Software installed on your computer to transfer photos from a memory card or storage device to your computer's hard drive for sharing photos online and printing from your computer.

Before transferring photos to your computer, you need to remove the memory card from your digital camera and insert it in the appropriate memory card slot on the HP All-in-One, or connect a storage device to the front USB port.

### To save photos

1. Insert a memory card into the appropriate slot on the HP All-in-One, or connect a storage device to the front USB port.  
The **Photosmart Express** menu appears, with the most recent photo shown on the display.



#### View



2. Press **▶** until **Save** is highlighted, and then press **OK**.  
If the HP All-in-One is network-connected, a list of available computers appears. Select the computer to which you want to transfer the photos, and then continue to the next step.
3. When the **Save to Computer** screen asks you to see the computer monitor for Import photo options, follow the onscreen prompts on your computer to save the photos to your computer.  
Only images that were not previously saved are copied to your computer.

## Edit photos using the control panel

The HP All-in-One offers several basic editing features that you can use to edit your photos manually before you print them, as well as a feature that enables you to automatically enhance your photos.

This section contains the following topics:

- [Zoom and pan to crop a photo](#)
- [Rotate a photo](#)
- [Adjust the brightness of your photos](#)
- [Apply special color effects to your photos](#)
- [Remove red-eye](#)
- [Automatically enhance your photos](#)

### Zoom and pan to crop a photo

The HP All-in-One enables you to zoom in or out on a specific area of a photo. When you print the photo, the photo is cropped so only the area shown on the display prints.

---

 **NOTE:** The changes you make to the photo apply only to viewing and printing the photo. The changes will not be saved on the memory card or storage device.

---

#### To crop a photo

1. Insert a memory card into the appropriate slot on the HP All-in-One, or connect a storage device to the front USB port.  
The **Photosmart Express** menu appears, with the most recent photo shown on the display.
2. With **View** highlighted, press **OK**.  
You can use **◀** or **▶** for highlighting options.  
The **View Photos** screen appears.
3. Press **◀** or **▶** to scroll through the thumbnails of your photos.
4. When the thumbnail of the photo you want to edit is highlighted, press **OK**.
5. When the selected photo appears by itself on the display, press **OK** again to display the **Photo Options** menu.
6. In the **Photo Options** menu, use **▲** or **▼** to highlight **Edit Photo**, and then press **OK**.  
The **Edit Photo** menu appears.

7. Use ▲ or ▼ to highlight **Crop**, and then press **OK**.  
The **Crop** screen appears.
8. Press **Zoom In** or **Zoom Out** to zoom closer to or farther away from the subject of the photo.  
An outline appears on the photo to show you an approximate view of the area that will print.
9. Press the arrows on the directional pad to pan around the photo and select a specific area to print.
10. Press **OK** to crop the photo.

## Rotate a photo

Depending how a photo is saved, the photo might appear sideways or upside down on the display. You might need to rotate the photo to make it show or print properly.

---

 **NOTE:** When printing more than one photo on a page, the HP All-in-One automatically adjusts the orientation of your photos to fit a maximum number of photos on the page. The rotation you apply here is ignored to accommodate the number of photos selected per page.

---

### To rotate a photo

1. Insert a memory card into the appropriate slot on the HP All-in-One, or connect a storage device to the front USB port.  
The **Photosmart Express** menu appears, with the most recent photo shown on the display.
2. With **View** highlighted, press **OK**.  
You can use ◀ or ▶ for highlighting options.  
The **View Photos** screen appears.
3. Press ◀ or ▶ to scroll through the thumbnails of your photos.
4. When the thumbnail of the photo you want to edit is highlighted, press **OK**.
5. When the selected photo appears by itself on the display, press **OK** again to display the **Photo Options** menu.
6. In the **Photo Options** menu, use ▲ or ▼ to highlight **Edit Photo**, and then press **OK**.  
The **Edit Photo** menu appears.
7. Use ▲ or ▼ to highlight **Rotate**, and then press **OK**.  
The **Rotate** screen appears.
8. Use ◀ or ▶ to flip the image 90 degrees clockwise or counterclockwise.
9. When you are done rotating the image, press **OK**.

## Adjust the brightness of your photos

You can adjust the brightness of a photo so that it prints lighter or darker than the original photo you took with your digital camera.

---

 **NOTE:** The changes you make to the photo apply only to viewing and printing the photo. The changes will not be saved on the memory card or storage device.

---

### To adjust the brightness

1. Insert a memory card into the appropriate slot on the HP All-in-One, or connect a storage device to the front USB port.  
The **Photosmart Express** menu appears, with the most recent photo shown on the display.
2. With **View** highlighted, press **OK**.  
You can use ◀ or ▶ for highlighting options.  
The **View Photos** screen appears.
3. Press ◀ or ▶ to scroll through the thumbnails of your photos.
4. When the thumbnail of the photo you want to edit is highlighted, press **OK**.
5. When the selected photo appears by itself on the display, press **OK** again to display the **Photo Options** menu.
6. In the **Photo Options** menu, use ▲ or ▼ to highlight **Edit Photo**, and then press **OK**.  
The **Edit Photo** menu appears.
7. Use ▲ or ▼ to highlight **Brightness**, and then press **OK**.  
The **Brightness** screen appears.
8. Press ◀ or ▶ to increase or decrease the brightness of the photo.  
The current brightness selection is indicated by the vertical line on the sidebar.
9. When you are done adjusting brightness, press **OK**.

### Apply special color effects to your photos

You can apply special color effects to a photo so that it prints with a sepia, hand-tinted, or black-and-white finish.

---

 **NOTE:** The changes you make to the photo apply only to viewing and printing the photo. The changes will not be saved on the memory card or storage device.

---

### To change the color effects

1. Insert a memory card into the appropriate slot on the HP All-in-One, or connect a storage device to the front USB port.  
The **Photosmart Express** menu appears, with the most recent photo shown on the display.
2. With **View** highlighted, press **OK**.  
You can use ◀ or ▶ for highlighting options.  
The **View Photos** screen appears.
3. Press ◀ or ▶ to scroll through the thumbnails of your photos.
4. When the thumbnail of the photo you want to edit is highlighted, press **OK**.
5. When the selected photo appears by itself on the display, press **OK** again to display the **Photo Options** menu.
6. In the **Photo Options** menu, use ▲ or ▼ to highlight **Edit Photo**, and then press **OK**.  
The **Edit Photo** menu appears.



7. Use ▲ or ▼ to highlight **Color Effect**, and then press **OK**. The **Color Effect** menu appears.
8. Use ▲ or ▼ to select one of the following color effect options, and then press **OK**:

<b>No Effect</b>	Does not apply any special color effects to your photo.
<b>Black &amp; White</b>	Prints the photo in black and white.
<b>Sepia</b>	Applies brown tones, similar to photos produced in the early 1900s, to your photo.
<b>Antique</b>	Applies brown tones along with some pale colors to your photo. With this option, your photo will look like it was hand-tinted.

The selected color effect is applied to the photo, and the photo is shown by itself on the display.

## Remove red-eye

The flash on a camera (especially on older model cameras) can sometimes cause a subject's eyes to appear red in your photos. You can remove redness so that eyes appear the correct shade in your photos.

### To remove red-eye from photos

1. Insert a memory card into the appropriate slot on the HP All-in-One, or connect a storage device to the front USB port.  
The **Photosmart Express** menu appears, with the most recent photo shown on the display.
2. With **View** highlighted, press **OK**.  
You can use ◀ or ▶ for highlighting options.  
The **View Photos** screen appears.
3. Press ◀ or ▶ to scroll through the thumbnails of your photos.
4. When the thumbnail of the photo you want to edit is highlighted, press **OK**.
5. When the selected photo appears by itself on the display, press **Red Eye Removal** on the control panel.

 **TIP:** Another method is to choose **Red Eye Removal** from the **Edit Photo** menu.

A red-eye icon blinks in the upper left corner of the photo, red-eye removal is applied, and the photo is shown by itself on the display.

## Automatically enhance your photos

The HP All-in-One is set up, by default, to enhance your photos automatically when you print them. The changes are only visible on your printed output; you cannot see the changes on the display.

When this feature is enabled, the HP All-in-One uses **HP Real Life Technologies** to:

- Adjust the brightness or darkness of your photos.
- Adjust the lighting to make dark images appear brighter.
- Sharpen blurry images.

You can turn off the automatic photo enhancement feature for individual photos, on a per-image basis.

### To turn off automatic photo enhancement

1. Insert a memory card into the appropriate slot on the HP All-in-One, or connect a storage device to the front USB port.  
The **Photosmart Express** menu appears, with the most recent photo shown on the display.
2. With **View** highlighted, press **OK**.  
You can use ◀ or ▶ for highlighting options.  
The **View Photos** screen appears.
3. Press ◀ or ▶ to scroll through the thumbnails of your photos.
4. When the thumbnail of the photo you want to edit is highlighted, press **OK**.
5. When the selected photo appears by itself on the display, press **OK** again to display the **Photo Options** menu.
6. In the **Photo Options** menu, use ▲ or ▼ to highlight **Edit Photo**, and then press **OK**.  
The **Edit Photo** menu appears.
7. Use ▲ or ▼ to highlight **Photo Fix**, and then press **OK**.  
The **Photo Fix** menu appears.
8. To turn off automatic photo enhancement, use ▲ or ▼ to select **Off**, and then press **OK**.



# 9 Use the scan features

Scanning is the process of converting text and pictures into an electronic format for your computer. You can scan almost anything (photos, magazine articles, film negatives, slides, and text documents) on the HP All-in-One.

You can use the scanning features of the HP All-in-One to do the following:

- Make reprints of your favorite photos.
- Scan text from an article into your word processor and quote it in a report.
- Print business cards and brochures by scanning a logo and using it in your publishing software.
- Send photos to friends and relatives by scanning your favorite prints and including them in e-mail messages.
- Create a photographic inventory of your house or office.
- Archive treasured photos in an electronic scrapbook.

This section contains the following topics:

- [Make reprints of your photos](#)
- [Scan an image](#)
- [Edit a scanned image](#)
- [Share a scanned image with friends and relatives](#)
- [Stop scanning](#)

## Make reprints of your photos

You can scan a printed copy of a photo to make reprints in a variety of sizes, up to the size of letter (8.5 x 11 inch) or A4 (210 x 297 mm) paper.

By default, the HP All-in-One is set to detect the type of paper you are using automatically. For the best results when reprinting photos, leave the **Paper Type** set to **Automatic**, and load photo paper in the HP All-in-One. You should only change the **Paper Type** if you see print quality issues using the **Automatic** setting.



**To reprint an original photo**

1. Press **Reprints** for the **Scan and Reprint** option.

---

 **NOTE:** You can also press **Scan Menu** on the control panel for the **Scan and Reprint** option.

**NOTE:** Depending on the paper size you choose, you can place the photo paper in the photo tray or the main input tray.

---

2. When prompted, load your original photo print side down on the right front corner of the glass, and then do one of the following:

**To reprint your original photo using the default print settings**

- ▲ Press **Print Photos** on the control panel.

**To change print settings before reprinting your original photo**

- a. Press **OK** to change print settings.  
The **Source of Original** screen appears.
- b. Press ▲ or ▼ to highlight any option and press **OK**.  
The **Print Layout** screen appears.
- c. Press ▲ or ▼ to highlight the print layout pattern and press **OK**.

---

 **NOTE:** Depending on the paper size you choose, you might be prompted to choose a layout for the photos on your pages.

---

The **Scan Preview** menu appears.

- d. Press ▲ or ▼ to adjust the number of copies and press **OK**.  
The **Reprint Options** screen appears.

---

 **NOTE:** The HP All-in-One scans your original and shows a preview of the photo on the display.

---

- e. Press **OK** to select **Print Preview** .

---

 **NOTE:** Select **Edit Photo** to edit photos before printing.

---

The **Print Preview** screen appears.

- f. Press ▲ or ▼ to highlight **Print Now** and press **OK** (or press **Print Photos** on the control panel).

## Scan an image

You can start a scan from your computer or from the control panel of the HP All-in-One. This section explains how to scan from the control panel of the HP All-in-One only.

---

 **NOTE:** You can also use the software you installed with the HP All-in-One to scan images. Using this software, you can edit a scanned image and create special projects using a scanned image.

---

To use the scan features, the HP All-in-One and computer must be connected and turned on. The HP All-in-One software must also be installed and running on your computer prior to scanning. To verify that the HP All-in-One software is running on a Windows computer,

look for the HP All-in-One icon in the system tray at the lower right side of the screen, near the time.

---

 **NOTE:** Closing the **HP Digital Imaging Monitor** icon in the Windows system tray can cause the HP All-in-One to lose some of its scan functionality. If this happens, you can restore full functionality by restarting your computer or by starting the HP Photosmart Software.

---

This section contains the following topics:

- [Scan an original to a computer](#)
- [Scan an original to a memory card or storage device](#)

## Scan an original to a computer

You can scan originals placed on the glass by using the control panel.



### To scan to a computer

1. Load your original print side down on the right front corner of the glass.
2. Press **Scan Menu**.
3. Press ▼ to highlight **Scan to Computer**, and then press **OK**.
4. If the HP All-in-One is connected to one or more computers on a network, do the following:
  - a. Press **OK** to select **Select Computer**.  
A list of the computers connected to the HP All-in-One appears on the display.

---

 **NOTE:** The **Select Computer** menu might list computers with a USB connection in addition to those connected through the network.

---

- b. Press **OK** to select the default computer, or press ▼ to select a different computer, and then press **OK**.  
The **Scan To** menu appears on the display, listing the applications on the selected computer.

If the HP All-in-One is connected directly to a computer with a USB cable, proceed to step 5.

5. Press **OK** to select the default application to receive the scan, or press ▼ to select a different application, and then press **OK**.  
A preview image of the scan appears on your computer, where you can edit it.
6. Make any edits to the preview image, and then click **Accept** when you are finished.

### Related topics

- [“Control panel features” on page 13](#)
- [“Scan Menu” on page 17](#)

## Scan an original to a memory card or storage device

You can send the scanned image as a JPEG image to the memory card that is currently inserted or a storage device that is currently attached to the front USB port. This enables

you to use the photo print options to print borderless prints and album pages from the scanned image.

---

 **NOTE:** If the HP All-in-One is connected to a network, you can access the scanned image only if the card or device is being shared across the network.

---

### To save a scan to a memory card or storage device

1. Make sure your memory card is inserted into the appropriate slot on the HP All-in-One, or a storage device is connected to the front USB port.
2. Load your original print side down on the right front corner of the glass.
3. Press the **Scan Menu** button.
4. Press ▼ to highlight **Scan to Memory Card**, and then press **OK**.  
The HP All-in-One scans the image and saves the file to the memory card or storage device in the JPEG format.

## Edit a scanned image

You can edit a scanned image using the software you installed with the HP All-in-One. You can also edit a scanned document by using your Optical Character Recognition (OCR) software.

---

 **NOTE:** If you are using HP Photosmart Essential, the Optical Character Recognition (OCR) software might not be installed on your computer. To install the OCR software, you must re-insert the software disk and select **OCR** under the **Custom** installation options.

---

This section contains the following topics:

- [Edit a scanned preview image](#)
- [Edit a scanned photo or graphic](#)
- [Edit a scanned document](#)

### Edit a scanned preview image

You can use the tools in the **HP Scanning** software to modify a preview image. Any changes that you make, such as brightness, image type, resolution, and more apply only to this scan session.

You can make additional changes in the HP Photosmart software after the image is scanned.

### Edit a scanned photo or graphic

You can edit a scanned photo or graphic using the software you installed with the HP All-in-One. Using this software, you can rotate or crop the image, as well as adjust the brightness, contrast, and color saturation.

### Edit a scanned document

Scanning text (also known as optical character recognition or OCR) enables you to bring the content of magazine articles, books, and other printed matter into your favorite word processor and many other programs as fully editable text. Learning to work with OCR

correctly is important if you want to obtain the best results. Do not expect scanned text documents to be letter-perfect the first time you use your OCR software. Using OCR software is an art that takes time and practice to master.

---

 **NOTE:** If you are using HP Photosmart Essential, the Optical Character Recognition (OCR) software might not be installed on your computer. To install the OCR software, you must re-insert the software disk and select **OCR** under the **Custom** installation options.

---

## Share a scanned image with friends and relatives

You can easily share scanned images with friends and family using the HP Photosmart Share online service. HP Photosmart Share enables you to send images to others as e-mail or upload photos to an online photo album or photo finishing service.

---

 **NOTE:** Availability of the services described here varies by country/region. Some of the services described here might not be available in your country/region.

---

### To send a scan of a photo or document

1. Load your original print side down on the right front corner of the glass.
2. Press **Scan Menu**.
3. Press **OK** to select **HP Photosmart Share** and send the scan to your computer. If the HP All-in-One is connected to one or more computers on a network, a **Select Computer** menu appears. Select the destination computer name.
4. Use the **HP Photosmart Share** Software on your computer to send the scan as thumbnail preview to an e-mail recipient (the full-size file can be downloaded later, at the recipient's convenience), to an online photo album or photo finishing service, or to a network-connected HP device.
5. The HP All-in-One sends the scanned photo or document to the computer or to all the share destinations that you selected.

### Related topics

[“Share photos using HP Photosmart Software” on page 107](#)

## Stop scanning

### To stop scanning

- ▲ Press **Cancel** on the control panel.





# 10 Use the copy features

The HP All-in-One enables you to produce high-quality color and black-and-white copies on a variety of paper types, including transparencies. You can enlarge or reduce the size of an original to fit a specific paper size, adjust the darkness of the copy, and use special features to make high-quality copies of photos, including borderless copies.

---

 **TIP:** For the best copy performance on standard copy projects, set the paper size to **Letter** or **A4**, the paper type to **Plain Paper**, and the copy quality to **Fast**.

---

This section contains the following topics:

- [Make a copy](#)
- [Preview your copy job](#)
- [Change the copy settings for the current job](#)
- [Change default copy settings](#)
- [Perform special copy jobs](#)
- [Stop copying](#)

## Make a copy

You can make quality copies from the control panel.

### To make a copy from the control panel

1. Make sure you have paper loaded in the input tray.
2. Load your original print side down on the right front corner of the glass or print side up in the document feeder tray.
3. Press **Start Copy Black** or **Start Copy Color** to begin copying.

### Related topics

[“Load an original in the automatic document feeder” on page 71](#)

## Preview your copy job

After changing settings on the HP All-in-One for making a copy, you can preview an image of the expected output on the display before starting the copy.

---

 **NOTE:** You must explicitly pick your copy settings to ensure an accurate preview. Automatic settings will not reflect the loaded paper size and type, but use defaults instead.

---

Previews appear when you select **Preview** on the **Copy Menu**, or when you use the crop feature to specify a specific area of the original to copy.

**To preview your copy from the control panel**

1. Press **Copy Menu**.  
The **Copy Menu** appears.
2. Change copy settings on the HP All-in-One to accurately reflect the copy you want to make.
3. Press ▼ to highlight **Preview**, and then press **OK**.  
An image on the display shows how your copy will print.
4. Press **Start Copy Black** or **Start Copy Color** to accept the preview and begin copying.

## Change the copy settings for the current job

You can customize the copy settings of the HP All-in-One to handle nearly any copy task.

This section contains the following topics:

- [Set the number of copies](#)
- [Set the copy paper size](#)
- [Set the copy paper type](#)
- [Change copy speed or quality](#)
- [Adjust the lightness and darkness of your copy](#)

### Set the number of copies

You can set the number of copies that you want to print by either using the **Copy Menu** button on the control panel or by selecting the appropriate options in your software application.

**To set the number of copies from the control panel**

1. Make sure you have paper loaded in the input tray.
2. Load your original print side down on the right front corner of the glass.
3. Press **Copy Menu**.  
The **Copy Menu** appears.
4. Press ▼ to highlight **Copies**, and then press **OK**.  
The **Copies** option appears.
5. Use the keypad or press ▲ to select the number of copies, up to the maximum.  
(The maximum number of copies varies by model.)

---

 **TIP:** If you hold down either of the arrow buttons, the number of copies changes by increments of 5 to make it easier to set a large number of copies.

---

6. Press **Start Copy Black** or **Start Copy Color**.

### Set the copy paper size

You can set the paper size on the HP All-in-One. The paper size you select should match what is loaded in the input tray.

### To set the paper size from the control panel

1. Press **Copy Menu**.  
The **Copy Menu** appears.
2. Press ▼ to highlight **Paper Size**, and then press **OK**.  
The **Paper Size** menu appears.
3. Press ▼ to highlight the appropriate paper size and then press **OK**.  
Refer to the following table to determine which paper size setting to choose, based on the paper loaded in the input tray.

Paper type	Suggested paper size settings
Copier, multi-purpose, or plain papers	8.5x11 inch or A4
Inkjet papers	8.5x11 inch or A4
Letterhead	8.5x11 inch or A4
Photo papers	10x15 cm 4x6 inch 13x18 cm 5x7 inch 8.5x11 inch A4 L (Japan only) 2L (Japan only) 20x25 cm (Germany only) Mutsugiri (Japan only)
Hagaki	Hagaki (Japan only)
Transparency films	8.5x11 inch or A4

### Set the copy paper type

You can set the paper type on the HP All-in-One. The default paper type setting for copying is **Automatic**, which causes the HP All-in-One to detect the type of paper in the input tray.

### To set the paper type for copies

1. Press **Copy Menu**.  
The **Copy Menu** appears.
2. Press ▼ to highlight **Paper Type**, and then press **OK**.  
The **Paper Type** menu appears.

3. Press ▼ until the appropriate paper type appears.

Refer to the following table to determine which paper type setting to choose based on the paper loaded in the input tray.

Paper type	Control panel setting
Copier paper or letterhead	Plain Paper
HP Bright White Paper	Plain Paper
HP Premium Plus Photo Paper, Glossy	Premium Photo
HP Premium Plus Photo Paper, Matte	Premium Photo
HP Premium Plus 10 x 15 cm (4 x 6 inch) Photo Paper	Premium Photo
HP Premium Plus 13 x 18 cm (5 x 7 inch) Photo Paper	Premium Photo
HP Photo Paper	Photo Paper
HP Everyday Photo Paper	Everyday Photo
HP Everyday Photo Paper, Semi Gloss	Everyday Matte
HP Premium Paper	Premium Inkjet
Other inkjet paper	Premium Inkjet
HP Professional Brochure & Flyer Paper (Glossy)	Brochure Glossy
HP Professional Brochure & Flyer Paper (Matte)	Brochure Matte
HP Premium or Premium Plus Inkjet Transparency Film	Transparency
Other transparency film	Transparency
Plain Hagaki	Plain Paper
Glossy Hagaki	Premium Photo
L (Japan only)	Premium Photo
Advanced Photo Paper	Advanced Photo

4. Press **OK**.

### Change copy speed or quality

The HP All-in-One provides four options that affect copy speed and quality:

- **Maximum dpi** produces the highest quality for all paper. **Maximum dpi** copies slower than the other quality settings.
- **Best** produces high quality for all paper and eliminates the banding (striping) effect that sometimes occurs in solid areas. **Best** copies slower than the **Normal** or **Fast** quality settings.

- **Normal** delivers high quality and is the recommended setting for most of your copying. **Normal** copies faster than **Best** and is the default setting.
- **Fast** copies faster than the **Normal** setting. The text is comparable to the quality of the **Normal** setting, but the graphics might be lower quality. The **Fast** setting uses less ink and extends the life of your ink cartridges.

#### To change the copy quality from the control panel

1. Make sure you have paper loaded in the input tray.
2. Load your original print side down on the right front corner of the glass.
3. Press **Copy Menu**.  
The **Copy Menu** appears.
4. Press ▼ to highlight **Quality**, and then press **OK**.  
The **Quality** menu appears.
5. Press ▼ to select a copy quality.
6. Press **OK**.

### Adjust the lightness and darkness of your copy

You can use the **Lighter/Darker** option to adjust the contrast of the copies you make.

#### To adjust the copy contrast from the control panel

1. Make sure you have paper loaded in the input tray.
2. Load your original print side down on the right front corner of the glass.
3. Press **Copy Menu**.  
The **Copy Menu** appears.
4. Press ▼ to highlight **Lighter/Darker**, and then press **OK**.  
The **Lighter/Darker** menu appears.
5. Do one of the following:
  - Press ► to darken the copy.
  - Press ◀ to lighten the copy.
6. Press **OK**.

### Change default copy settings

When you change copy settings from the control panel, the settings apply only to the current copy job. To apply copy settings to all future copy jobs, you can save the settings as defaults.

#### To set default copy settings from the control panel

1. Make any needed changes to the copy settings.
2. Press **Copy Menu**.  
The **Copy Menu** appears.
3. Press ▼ to highlight **Set As New Defaults**, and then press **OK**.
4. Press ▼ to highlight **Yes, change defaults**, and then press **OK**.

 **NOTE:** The settings you specify here are only saved on the HP All-in-One. They do not adjust the settings in the software. You can save your most frequently used settings by using the software that you installed with the HP All-in-One.

## Perform special copy jobs

In addition to supporting standard copy jobs, the HP All-in-One can perform special jobs such as copying borderless photos and resizing originals.

This section contains the following topics:

- [Make a borderless copy of a photo](#)
- [Resize an original to fit onto letter or A4 paper](#)
- [Resize an original using custom settings](#)
- [Crop an original](#)
- [Shift the left margin](#)
- [Improve the quality of a copy](#)

### Make a borderless copy of a photo

For the best quality when copying a photo, load 10 x 15 cm (4 x 6 inch) photo paper in the photo tray and change your copy settings for the correct paper type and photo enhancement.

#### To make a borderless copy of a photo from the control panel

1. Load 10 x 15 cm (4 x 6 inch) photo paper into the photo tray.

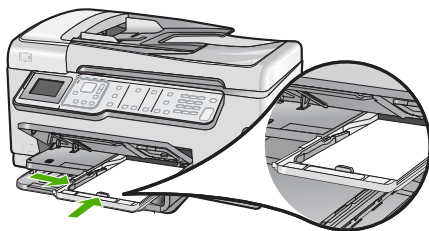

2. Load your original photo print side down on the right front corner of the glass. Position the photo on the glass so the long edge of the photo is along the front edge of the glass, as indicated by the engraved guides along the edge of the glass.
3. Press **Start Copy Black** or **Start Copy Color**.  
The HP All-in-One makes a 10 x 15 cm (4 x 6 inch) borderless copy of your original photo.

 **NOTE:** If you loaded tabbed paper in the photo tray, you can remove the tab from the copy of your photo once the ink has completely dried.

 **TIP:** If the output is not borderless, set the paper type to **Premium Photo**, and then try making the copy again.

## Related topics

- [“Load 10 x 15 cm \(4 x 6 inch\) photo paper”](#) on page 78
- [“Set the copy paper type”](#) on page 123

## Resize an original to fit onto letter or A4 paper

You can use the **Fit to Page** feature to copy an original to fit within the printable margins of a page without the risk of cropping some part of your original. This is useful for reducing or enlarging an original. For example:

- If you enlarge a 10 x 15 cm (4 x 6 inch) photo to make a borderless full-size copy on letter or A4 paper, some part of your photo will be cropped. The **Fit to Page** feature will enlarge the photo as much as possible to fit the page without cropping any part of your photo.
- If the image or text on your original fills the entire sheet of paper with no margins, you can use the **Fit to Page** feature to reduce your original and prevent unwanted cropping of the text or images at the edges of the sheet.

---

 **NOTE:** In order to resize your original without changing the proportions or cropping the edges, the HP All-in-One might leave an uneven amount of white space around the edges of the paper.

---



### To resize a document from the control panel

1. Make sure you have paper loaded in the input tray.
2. Load your original print side down on the right front corner of the glass.
3. Press **Copy Menu**.  
The **Copy Menu** appears.
4. Press ▼ to highlight **Size**, and then press **OK**.  
The **Size** menu appears.
5. Press ▼ to highlight **Fit to Page**, and then press **OK**.

## Resize an original using custom settings

You can use your own custom settings to reduce or enlarge a copy of a document.

### To set a custom size from the control panel

1. Make sure you have paper loaded in the input tray.
2. Load your original print side down on the right front corner of the glass.
3. Press **Copy Menu**.  
The **Copy Menu** appears.



4. Press ▼ to highlight **Size**, and then press **OK**.  
The **Size** menu appears.
5. Press ▼ to highlight **Custom 100%**, and then press **OK**.  
The **Custom 100%** menu appears.
6. Use the keypad or press ▼ or ▲ to select a percentage to reduce or enlarge the copy.  
(The minimum and maximum percentage to resize a copy varies by model.)
7. Press **OK**.

## Crop an original

After changing settings on the HP All-in-One for making a copy, you can use the crop feature to specify a particular area of the original to copy.

### To crop your copy from the control panel

1. Press **Copy Menu**.  
The **Copy Menu** appears.
2. Change copy settings on the HP All-in-One to accurately reflect the copy you want to make.
3. Press ▼ to highlight **Crop**, and then press **OK**.  
The **Crop** screen appears.
4. Press the arrows on the directional pad to move the cursor to the upper left corner where you want the crop to begin, and then press **OK**.
5. Press ▼ and ► to move the cursor to the lower right corner of the crop area, and then press **OK**.  
The HP All-in-One shows a preview image of the expected output on the display.
6. Press **Start Copy Black** or **Start Copy Color** to accept the preview and begin copying.

## Shift the left margin

You can shift the left margin of the copies by using the **Margin Shift** option. This helps in binding or 3-hole punching for the copies produced. The HP All-in-One shifts the image on the copies produced 0.95 cm (3/8 inch) to the right.

---

 **NOTE:** When the **Margin Shift** feature is enabled, the right side of the copy images may be cropped.

---

### To shift the margin for your copy from the control panel

1. Press **Copy Menu**.  
The **Copy Menu** appears.
2. Change copy settings on the HP All-in-One to accurately reflect the copy you want to make.
3. Press ▼ to highlight **Margin Shift**, and then press **OK**.  
The **Margin Shift** menu appears.
4. Press ▼ to highlight **On**, and then press **OK**.
5. Press **Start Copy Black** or **Start Copy Color** to begin copying.

## Improve the quality of a copy

You can use the **Enhancements** feature to adjust the quality of text documents by sharpening edges of black text or adjust photographs by enhancing light colors that might otherwise appear white.

The **Mixed** enhancement is the default option. Use the **Mixed** enhancement to sharpen edges of most originals. You can use **Photo** enhancements to enhance light colors that might otherwise appear white.

You might be able to fix the following types of issues by changing the **Enhancements** setting to **Photo** or **None**:

- Stray dots of color surround some text on your copies
- Large, black typefaces look splotchy (not smooth)
- Thin, colored objects or lines contain black sections
- Horizontal grainy or white bands appear in light- to medium-gray areas

### To copy a blurred document from the control panel

1. Make sure you have paper loaded in the input tray.
2. Load your original print side down on the right front corner of the glass.
3. Press **Copy Menu**.  
The **Copy Menu** appears.
4. Press ▼ to highlight **Enhancements**, and then press **OK**.  
The **Enhancements** menu appears.
5. Press ▼ to highlight **Text**, and then press **OK**.
6. Press **Start Copy Black** or **Start Copy Color**.

### To copy an overexposed photo

1. Make sure you have paper loaded in the input tray.
2. Position the photo on the glass so the long edge of the photo is along the front edge of the glass.  
Load your original print side down on the right front corner of the glass.
3. Press **Copy Menu**.  
The **Copy Menu** appears.
4. Press ▼ to highlight **Enhancements**, and then press **OK**.  
The **Enhancements** menu appears.
5. Press ▼ to highlight **Photo**, and then press **OK**.
6. Press **Start Copy Black** or **Start Copy Color**.

## Stop copying

### To stop copying

- ▲ Press **Cancel** on the control panel.



# 11 Use the fax features

You can use the HP All-in-One to send and receive faxes, including color faxes. You can set up speed dial entries to send faxes quickly and easily to frequently used numbers. From the control panel, you can also set a number of fax options, such as resolution and the contrast between lightness/darkness on the faxes you send.

---

 **NOTE:** Before you begin faxing, make sure you have set up the HP All-in-One properly for faxing. You might have already done this as part of the initial setup, by using either the control panel or the software that came with the HP All-in-One.

You can verify the fax is set up correctly by running the fax setup test from the control panel. You can access this test from the Setup menu.

---

This section contains the following topics:

- [Send a fax](#)
- [Receive a fax](#)
- [Fax over the Internet using IP phone](#)
- [Stop faxing](#)

## Send a fax

You can send a fax in a variety of ways. Using the control panel, you can send a black-and-white or color fax from the HP All-in-One. You can also send a fax manually from an attached phone. This allows you to speak with the recipient before sending the fax.

This section contains the following topics:

- [Send a basic fax](#)
- [Send a fax using speed dials](#)
- [Send a fax manually from a phone](#)
- [Send a fax using monitor dialing](#)
- [Scan a fax to send from memory](#)
- [Schedule a fax to send later](#)
- [Broadcast a fax to multiple recipients](#)
- [Send a color original or photo fax](#)
- [Change the fax resolution and Lighter/Darker settings](#)
- [Send a fax in Error Correction Mode](#)

## Send a basic fax

You can easily send a single- or multiple-page black-and-white fax by using the control panel, as described here.

---

 **NOTE:** If you need printed confirmation that your faxes were successfully sent, enable fax confirmation **before** sending any faxes.

 **TIP:** You can also send a fax manually from a phone or by using monitor dialing. These features allow you to control the pace of your dialing. They are also useful when you want to use a calling card to charge the call and you need to respond to tone prompts while dialing.

---

### To send a basic fax from the control panel

1. Load your originals print side up into the document feeder tray. If you are sending a single-page fax, such as a photograph, you can also load your original print side down on the glass.

 **NOTE:** If you are sending a multiple-page fax, you must load the originals in the document feeder tray. You cannot fax a multiple-page document from the glass.

---

2. Press **Fax Menu**.

Enter the fax number by using the keypad, press ▲ to redial the last number dialed, or press ▼ to access speed dials.

---

 **TIP:** To add a pause in the fax number you are entering, press the **Symbols (\*)** button repeatedly until a dash (-) appears on the display.

---

3. Press **Start Fax Black**.

- **If the device detects an original loaded in the automatic document feeder**, the HP All-in-One sends the document to the number you entered.
  - **If the device does not detect an original loaded in the automatic document feeder**, the **Feeder Empty** prompt appears. Make sure your original is loaded print side down on the glass, and then press ▼ to highlight **Fax original from scanner glass**, and press **OK**.
- 

 **TIP:** If the recipient reports issues with the quality of the fax you sent, you can try changing the resolution or contrast of your fax.

---

### Related topics

- [“Send a fax manually from a phone” on page 133](#)
- [“Send a fax using monitor dialing” on page 134](#)
- [“Change the fax resolution and Lighter/Darker settings” on page 137](#)
- [“Print fax confirmation reports” on page 150](#)
- [“Send a color original or photo fax” on page 136](#)

## Send a fax using speed dials

You can quickly send a black-and-white or color fax from the HP All-in-One using speed dials. This section provides instructions for sending the fax in black and white.

## To send a fax using speed dials from the control panel

1. Load your originals print side up into the document feeder tray. If you are sending a single-page fax, such as a photograph, you can also load your original print side down on the glass.



**NOTE:** If you are sending a multiple-page fax, you must load the originals in the document feeder tray. You cannot fax a multiple-page document from the glass.

---

2. Press **Fax Menu**.
3. Press ▼ to access speed dials.
4. Press ▼ until the appropriate speed dial entry is highlighted, or enter the speed dial code by using the keypad on the control panel.  
Press **OK**.
5. Press **Start Fax Black**.
  - **If the device detects an original loaded in the automatic document feeder**, the HP All-in-One sends the document to the number you entered.
  - **If the device does not detect an original loaded in the automatic document feeder**, the **Feeder Empty** prompt appears. Make sure your original is loaded print side down on the glass, and then press ▼ to highlight **Fax original from scanner glass**, and press **OK**.



**TIP:** If the recipient reports issues with the quality of the fax you sent, you can try changing the resolution or contrast of your fax.

---

### Related topics

[“Set up speed dialing” on page 65](#)

## Send a fax manually from a phone

Sending a fax manually allows you to make a phone call and talk with the recipient before you send the fax. This is useful if you want to inform the recipient that you are going to send them a fax before sending it. When you send a fax manually, you can hear the dial tones, telephone prompts, or other sounds through the handset on your telephone. This makes it easy for you to use a calling card to send your fax.

Depending on how the recipient has their fax machine set up, the recipient might answer the phone, or the fax machine might take the call. If a person answers the phone, you can speak with the recipient before sending the fax. If a fax machine answers the call, you can send the fax directly to the fax machine when you hear the fax tones from the receiving fax machine.

### To send a fax manually from a connected phone

1. Load your originals print side up into the document feeder tray.

---

 **NOTE:** This feature is not supported if you load your originals on the glass. You must load your originals in the document feeder tray.

---

2. Dial the number by using the keypad on the phone that is connected to the HP All-in-One.

---

 **NOTE:** Do not use the keypad on the control panel of the HP All-in-One. You must use the keypad on your phone to dial the recipient's number.

---

3. If the recipient answers the telephone, you can engage in a conversation before sending your fax.

---

 **NOTE:** If a fax machine answers the call, you will hear fax tones from the receiving fax machine. Proceed to the next step to transmit the fax.

---

4. Once you are ready to send the fax, press **Start Fax Black** or **Start Fax Color**.

If you were speaking with the recipient before sending the fax, inform the recipient that they should press Start on their fax machine after they hear fax tones.

The telephone line is silent while the fax is transmitting. At this point, you can hang up the telephone. If you want to continue speaking with the recipient, remain on the line until the fax transmission is complete.

### Send a fax using monitor dialing

Monitor dialing allows you to dial a number from the control panel as you would dial a regular telephone. When you send a fax using monitor dialing, you can hear the dial tones, telephone prompts, or other sounds through the speakers on the HP All-in-One. This enables you to respond to prompts while dialing, as well as control the pace of your dialing.

---

 **NOTE:** Make sure the fax volume is turned on, or you will not hear a dial tone.

---

### To send a fax using monitor dialing from the control panel

1. Load your originals print side up into the document feeder tray. If you are sending a single-page fax, such as a photograph, you can also load your original print side down on the glass.
2. Press **Start Fax Black** or **Start Fax Color**.
3. Once you hear the dial tone, enter the number by using the keypad on the control panel.
4. Follow any prompts that might occur.  
Your fax is sent when the receiving fax machine answers.

### Related topics

- [“Adjust the volume” on page 26](#)
- [“Set up speed dialing” on page 65](#)

## Scan a fax to send from memory

You can scan a black-and-white fax into memory and then send the fax from memory. This feature is useful if the fax number you are trying to reach is busy or temporarily unavailable. The HP All-in-One scans the originals into memory and sends them once it is able to connect to the receiving fax machine. After the HP All-in-One scans the pages into memory, you can immediately remove the originals from the document feeder tray.

### To scan a fax to send from memory

1. Load your originals print side up into the document feeder tray. If you are sending a single-page fax, such as a photograph, you can also load your original print side down on the glass.
2. Press the **Fax Menu** button twice to advance to the **Fax Menu**.
3. Press ▼ until **Scan and Fax** is highlighted, and then press **OK**.
4. Enter the fax number by using the keypad.
5. Press **Start Fax Black**.



**NOTE:** If you press **Start Fax Color**, the fax will be sent in black and white and a message appears on the display.

The HP All-in-One scans the originals into memory and sends the fax when the receiving fax machine is available.

## Schedule a fax to send later

You can schedule a black-and-white fax to be sent within the next 24 hours. This enables you to send a black-and-white fax late in the evening, when phone lines are not as busy or phone rates are lower, for example. The HP All-in-One automatically sends your fax at the specified time.

You can only schedule one fax to be sent at a time. You can continue to send faxes normally, however, while a fax is scheduled.



**NOTE:** You cannot schedule a color fax due to memory limitations.

### To schedule a fax from the control panel

1. Load your originals print side up into the document feeder tray.
2. Press the **Fax Menu** button twice to advance to the **Fax Menu**.
3. Press ▼ until **Send Fax Later** is highlighted, and then press **OK**.
4. Enter the send time by using the numeric keypad, and then press **OK**. If prompted, press **1** for **AM**, or **2** for **PM**.
5. Enter the fax number by using the keypad.
6. Press **Start Fax Black**.

The HP All-in-One scans all pages and the scheduled time appears on the display. The HP All-in-One sends the fax at the scheduled time.



**To cancel a scheduled fax**

1. Press the **Fax Menu** button twice to advance to the **Fax Menu**.
2. Press ▼ to highlight **Send Fax Later** and then press **OK**.  
The **Fax Is Scheduled** screen appears.
3. Press ▼ to highlight **Cancel scheduled fax** and press **OK**.

---

 **NOTE:** You can also cancel the scheduled fax by pressing **Cancel** on the control panel when the **Send Fax Later** message is visible on the display.

---

**Broadcast a fax to multiple recipients**

You can send a fax to multiple recipients without first setting up a group speed dial.

 **NOTE:** The list of recipients you specify for this fax is not saved and only works for sending faxes in black. If you intend to send other faxes to the same recipient list, you should create a group speed dial list.

---

**To broadcast a fax to multiple recipients from the control panel**

1. Press **Fax Menu** twice to advance to the **Fax Menu** screen.
2. Press ▼ to highlight **Broadcast Fax**, and press **OK**.  
The **Enter Fax Number** screen appears.
3. Enter the fax number by using the keypad, or press ▼ to access speed dials.

---

 **NOTE:** You can add up to 20 individual fax numbers.

---

4. Press **Start Fax Black**.
5. When prompted, load your originals print side up and top first in the center of the document feeder tray.
6. Press **Start Fax Black** again.

**Related topics**

[“Set up group speed dial entries” on page 66](#)

**Send a color original or photo fax**

You can fax a color original or photo from the HP All-in-One. If the HP All-in-One determines that the recipient's fax machine only supports black-and-white faxes, the HP All-in-One sends the fax in black and white.

HP recommends that you use only color originals for color faxing.

## To send a color fax from the control panel

1. Load your originals print side up into the document feeder tray. If you are sending a single-page fax, such as a photograph, you can also load your original print side down on the glass.

---

 **NOTE:** If you are sending a multiple-page fax, you must load the originals in the document feeder tray. You cannot fax a multiple-page document from the glass.

---

2. Enter the fax number by using the keypad.

---

 **TIP:** To add a pause in the fax number you are entering, press the **Symbols (\*)** button repeatedly until a dash (-) appears on the display.

---

3. Press **Start Fax Color**.

- **If the device detects an original loaded in the automatic document feeder,** the HP All-in-One sends the document to the number you entered.
- **If the device does not detect an original loaded in the automatic document feeder, the Feeder Empty** prompt appears. Make sure your original is loaded print side down on the glass, and then press ▼ to highlight **Fax original from scanner glass**, and press **OK**.

---

 **NOTE:** If the recipient's fax machine only supports black-and-white faxes, the HP All-in-One automatically sends the fax in black and white. A message appears after the fax has been sent indicating that the fax was sent in black and white. Press **OK** to clear the message.

---

## Change the fax resolution and Lighter/Darker settings

You can change the **Resolution** and **Lighter/Darker** settings for documents that you are faxing.

---

 **NOTE:** These settings do not affect copy settings. Copy resolution and lightness/darkness are set independently from fax resolution and lightness/darkness. Also, the settings that you change from the control panel do not affect faxes you send from your computer.

---

This section contains the following topics:

- [Change the fax resolution](#)
- [Change the Lighter/Darker setting](#)
- [Set new default settings](#)

### Change the fax resolution

The **Resolution** setting affects the transmission speed and quality of faxed black-and-white documents. If the receiving fax machine does not support the resolution you have chosen, the HP All-in-One sends faxes at the highest resolution supported by the receiving fax machine.

---

 **NOTE:** You can only change the resolution for faxes that you are sending in black and white. The HP All-in-One sends all color faxes using **Fine** resolution.

---

The following resolution settings are available for sending faxes: **Fine**, **Very Fine**, **Photo**, and **Standard**.

- **Fine**: provides high-quality text suitable for faxing most documents. This is the default setting. When sending faxes in color, the HP All-in-One always uses the **Fine** setting.
- **Very Fine**: provides the best quality fax when you are faxing documents with very fine detail. If you choose **Very Fine**, be aware that the faxing process takes longer to complete and you can only send black-and-white faxes using this resolution. If you send a color fax, it will be sent using **Fine** resolution instead.
- **Photo**: provides the best quality fax when sending photographs in black and white. If you choose **Photo**, be aware that the faxing process takes longer to complete. When faxing photographs in black and white, HP recommends that you choose **Photo**.
- **Standard**: provides a lower quality fax so that the faxing process will take less time to complete.

When you exit the Fax menu, this option returns to the default setting unless you set your changes as the default.

### To change the resolution from the control panel

1. Press **Fax Menu**.  
The **Enter Fax Number** screen appears.
2. Enter the fax number by using the keypad, press ▲ to redial the last number dialed, or press ▼ to access speed dials.
3. Press **Fax Menu** again.  
The **Fax Menu** appears.
4. Press ▼ to highlight **Resolution**, and then press **OK**.  
Press ▼ to highlight a resolution setting, and then press **OK**.
5. Press **Start Fax Black**.

---

 **NOTE:** If you press **Start Fax Color**, the fax will be sent using the **Fine** setting.

---

6. When prompted, load your originals print side up and top first in the center of the document feeder tray.
7. Press **Start Fax Black** again.

### Related topics

[“Set new default settings” on page 139](#)

### Change the Lighter/Darker setting

You can change the contrast of a fax to be darker or lighter than the original. This feature is useful if you are faxing a document that is faded, washed out, or handwritten. You can darken the original by adjusting the contrast.

---

 **NOTE:** The **Lighter/Darker** setting applies to black and white faxes only, not color faxes.

---

When you exit the Fax menu, this option returns to the default setting unless you set your changes as the default.

### To change the Lighter/Darker setting from the control panel

1. Press **Fax Menu**.  
The **Enter Fax Number** screen appears.
2. Enter the fax number by using the keypad, press ▲ to redial the last number dialed, or press ▼ to access speed dials.
3. Press **Fax Menu** again.  
The **Fax Menu** appears.
4. Press ▼ to highlight **Lighter/Darker**, and then press **OK**.  
The **Lighter/Darker** menu appears.
5. Press ◀ to lighten the fax or press ▶ to darken it.  
The indicator moves to the left or right as you press an arrow.
6. Press **Start Fax Black**.
7. When prompted, load your originals print side up and top first in the center of the document feeder tray.
8. Press **Start Fax Black** again.

### Related topics

[“Set new default settings” on page 139](#)

### Set new default settings

You can change the default value for the **Resolution** and **Lighter/Darker** settings through the control panel.

### To set new default settings from the control panel

1. Press **Fax Menu** until the **Fax Menu** appears.  
You might need to press **Fax Menu** more than once to display this menu.
2. Make your changes to **Resolution** and **Lighter/Darker**.
3. Press ▼ to highlight **Set As New Defaults**, and then press **OK**.

## Send a fax in Error Correction Mode

**Error Correction Mode** (ECM) prevents loss of data due to poor phone lines by detecting errors that occur during transmission and automatically requesting retransmission of the erroneous portion. Phone charges are unaffected, or might even be reduced, on good phone lines. On poor phone lines, ECM might increase sending time and phone charges, but sends the data much more reliably. The default setting is **On**. Turn ECM off only if it increases phone charges substantially, and you can accept poorer quality in exchange for reduced charges.

Before turning the ECM setting off, consider the following. If you turn ECM off

- The quality and transmission speed of faxes you send and receive are affected.
- The **Fax Speed** is automatically set to **Medium (14400)**.
- You will no longer be able to send or receive faxes in color.

**To change the ECM setting from the control panel**

1. Press **Setup**.
2. Press ▼ to highlight **Advanced Fax Setup**, and then press **OK**.  
The **Advanced Fax Setup** menu appears.
3. Press ▼ to highlight **Error Correction Mode**, and then press **OK**.  
The **Error Correction Mode** menu appears.
4. Press ▼ to highlight **Off** or **On**.
5. Press **OK**.

## Receive a fax

The HP All-in-One can receive faxes automatically or manually. If you turn off the **Auto Answer** option, you will need to receive faxes manually. If you turn on the **Auto Answer** option (the default setting), the HP All-in-One automatically answers incoming calls and receives faxes after the number of rings specified by the **Rings to Answer** setting. (The default **Rings to Answer** setting is five rings.)

You can receive faxes manually from a phone that is:

- Directly connected to the HP All-in-One (on the 2-EXT port)
- On the same telephone line, but not directly connected to the HP All-in-One

If you receive a legal-size fax and the HP All-in-One is not currently set to use legal-size paper, the device reduces the fax so that it fits on the paper that is loaded in the HP All-in-One. If you have disabled the **Automatic Reduction** feature, the HP All-in-One might print the fax on more than one page.

This section contains the following topics:

- [Receive a fax manually](#)
- [Set up backup fax reception](#)
- [Reprint received faxes from memory](#)
- [Poll to receive a fax](#)
- [Forward faxes to another number](#)
- [Set the paper size for received faxes](#)
- [Set up the HP All-in-One to check the paper type before printing faxes](#)
- [Set automatic reduction for incoming faxes](#)
- [Block junk fax numbers](#)

### Receive a fax manually

When you are on the phone, the person you are speaking with can send you a fax while you are still connected. This is referred to as manual faxing. Use the instructions in this section to receive a manual fax.

You can receive faxes manually from a phone that is:

- Directly connected to the HP All-in-One (on the 2-EXT port)
- On the same phone line, but not directly connected to the HP All-in-One

### To receive a fax manually

1. Make sure the HP All-in-One is turned on and you have paper loaded in the input tray.
2. Remove any originals from the document feeder tray.
3. Set the **Rings to Answer** setting to a high number to allow you to answer the incoming call before the HP All-in-One answers. Or, turn off the **Auto Answer** setting so that the HP All-in-One does not automatically answer incoming calls.
4. If you are currently on the phone with the sender, instruct the sender to press Start on their fax machine.
5. When you hear fax tones from a sending fax machine, do the following:
  - a. Press **Start Fax Black** or **Start Fax Color** on the control panel of the HP All-in-One.
  - b. When prompted, press ▼ to highlight **Receive Fax Manually**, and then press **OK**.
6. Press **Start Fax Black** again.
7. After the HP All-in-One begins to receive the fax, you can hang up the phone or remain on the line. The phone line is silent during fax transmission.

### Related topics

- [“Set the number of rings before answering” on page 62](#)
- [“Set the answer mode” on page 62](#)

## Set up backup fax reception

Depending on your preference and security requirements, you can set up the HP All-in-One to store all the faxes it receives, only the faxes it receives while the device is in an error condition, or none of the faxes it receives.

The following **Backup Fax Reception** modes are available:

<b>On</b>	<p>The default setting. When <b>Backup Fax Reception</b> is <b>On</b>, the HP All-in-One stores all faxes it receives in memory. This enables you to reprint one or all of the most recently printed faxes if they are still saved in memory.</p> <hr/> <p><b>NOTE:</b> When the memory gets low, the HP All-in-One overwrites the oldest, printed faxes as it receives new faxes. If the memory becomes full of unprinted faxes, the HP All-in-One will stop answering incoming fax calls.</p> <hr/> <p><b>NOTE:</b> If you receive a fax that is too large, such as a very detailed color photo, it might not be stored in memory due to memory limitations.</p>
<b>On Error Only</b>	<p>Causes the HP All-in-One to store faxes in memory only if there is an error condition that prevents the HP All-in-One from printing the faxes (for example, if the HP All-in-One runs out of paper). The HP All-in-One will continue to store incoming faxes as long as there is memory available. (If the memory becomes full, the HP All-in-One will stop answering incoming fax calls.) When the error condition is resolved, the faxes stored in memory print automatically and are then deleted from memory.</p>
<b>Off</b>	<p>Means that faxes are never stored in memory. (You might want to turn off <b>Backup Fax Reception</b> for security purposes, for example.) If an error condition occurs that prevents the HP All-in-One from printing (for example, the HP All-in-One runs out of paper), the HP All-in-One will stop answering incoming fax calls.</p>

---

 **NOTE:** If **Backup Fax Reception** is enabled and you turn off the HP All-in-One, all faxes stored in memory are deleted, including any unprinted faxes that you might have received while the HP All-in-One was in an error condition. You will need to contact the senders to ask them to resend any unprinted faxes. For a list of the faxes you have received, print the **Fax Log**. The **Fax Log** is not deleted when the HP All-in-One is turned off.

---

### To set backup fax reception from the control panel

1. Press **Setup**.
2. Press ▼ to highlight **Advanced Fax Setup**, and then press **OK**.  
The **Advanced Fax Setup** menu appears.
3. Press ▼ to highlight **Backup Fax Reception**, and then press **OK**.  
The **Backup Fax Reception** menu appears.
4. Press ► to highlight **On**, **On Error Only**, or **Off**.
5. Press **OK**.

### Related topics

[“Reprint received faxes from memory” on page 142](#)

## Reprint received faxes from memory

If you set the **Backup Fax Reception** mode to **On**, the HP All-in-One stores faxes it receives in memory, whether the device has an error condition or not.

---

 **NOTE:** After the memory becomes full, the HP All-in-One overwrites the oldest, printed faxes as it receives new faxes. If all the stored faxes are unprinted, the HP All-in-One will not receive any more fax calls until you print or delete the faxes from memory. You might also want to delete the faxes in memory for security or privacy purposes.

---

You can choose to reprint one or reprint all faxes in memory. For example, you might need to reprint your faxes if you lost the copy of your last printout.

### To reprint faxes in memory from the control panel

1. Make sure you have paper loaded in the input tray.
2. Press **Setup**.
3. Press ▼ to highlight **Tools**, and then press **OK**.  
The **Tools** menu appears.
4. Press ▼ to highlight **Reprint Faxes in Memory**, and then press **OK**.  
The **Reprint** menu appears.
5. Do one of the following:

#### To reprint one fax from memory

- a. Press ▼ to highlight **One Fax**, and then press **OK**.  
The **Select Fax** menu appears.
- b. Press ▼ to highlight a fax number, and then press **OK**.

### To reprint all faxes in memory

- ▲ Press ▼ to highlight **All faxes in memory**, and then press **OK**.
- 6. If you want to stop reprinting the faxes in memory, press **Cancel**.

### To delete all the faxes in memory from the control panel

1. Press **Setup**.
2. Press ▼ to highlight **Tools**, and then press **OK**.  
The **Tools** menu appears.
3. Press ▼ to highlight **Clear Fax Log**, and then press **OK**.

---

 **NOTE:** You can also delete any faxes stored in memory by turning off the HP All-in-One. Press the **On** button to turn off the HP All-in-One. All faxes stored in memory will be deleted from memory when you turn off the power to the HP All-in-One.

---

### Related topics

[“Set up backup fax reception” on page 141](#)

## Poll to receive a fax

Polling allows the HP All-in-One to ask another fax machine to send a fax that it has in its queue. When you use the **Poll to Receive** feature, the HP All-in-One calls the designated fax machine and requests the fax from it. The designated fax machine must be set for polling and have a fax ready to send.

---

 **NOTE:** The HP All-in-One does not support polling pass codes. Polling pass codes are a security feature that require the receiving fax machine to provide a pass code to the device it is polling in order to receive the fax. Make sure the device you are polling does not have a pass code set up or the HP All-in-One will not be able to receive the fax.

---

### To set up poll to receive a fax from the control panel

1. Press the **Fax Menu** button twice to advance to the **Fax Menu**.
2. Press ▼ to highlight **Poll to Receive**, and then press **OK**.
3. When prompted, enter the fax number of the other fax machine.
4. Press **Start Fax Black** or **Start Fax Color**.

---

 **NOTE:** If you press **Start Fax Color** but the sender sent the fax in black and white, the HP All-in-One prints the fax in black and white.

---

## Forward faxes to another number

You can set up the HP All-in-One to forward your faxes to another fax number. If you receive a color fax, the HP All-in-One forwards the fax in black and white.

HP recommends that you verify the number you are forwarding to is a working fax line. Send a test fax to make sure the fax machine is able to receive your forwarded faxes.



### To forward faxes from the control panel

1. Press **Setup**.
2. Press ▼ to highlight **Advanced Fax Setup**, and then press **OK**.  
The **Advanced Fax Setup** menu appears.
3. Press ▼ to highlight **Fax Forwarding**, and then press **OK**.  
The **Fax Forwarding** menu appears.
4. Press ▼ until **On-Forward** or **On-Print & Forward** appears, and then press **OK**.
  - Choose **On-Forward** if you want to forward the fax to another number without printing a backup copy on the HP All-in-One.

---

 **NOTE:** If the HP All-in-One is not able to forward the fax to the designated fax machine (if it is not turned on, for example), the HP All-in-One will print the fax. If you set up the HP All-in-One to print error reports for received faxes, it will also print an error report.

---

- Choose **On-Print & Forward** to print a backup copy of your received fax on the HP All-in-One while forwarding the fax to another number.
5. At the prompt, enter the number of the fax machine that will receive the forwarded faxes, and then press **OK**.
  6. At the prompt, enter a start time and date and a stop time and date, and then press **OK**.

If the HP All-in-One loses power when **Fax Forwarding** is set up, the HP All-in-One saves the **Fax Forwarding** setting and phone number. When power is restored to the device, the **Fax Forwarding** setting is still **On**.

---

 **NOTE:** You can cancel fax forwarding by pressing **Cancel** on the control panel when the **Fax Forwarding** message is visible on the display, or you can select **Off** from the **Fax Forwarding** menu.

---

### Set the paper size for received faxes

You can select the paper size for received faxes. The paper size you select should match what is loaded in your input tray. Faxes can be printed on letter, A4, or legal paper only.

---

 **NOTE:** If an incorrect paper size is loaded in the input tray when you receive a fax, the fax does not print and an error message appears on the display. Load letter, A4, or legal paper, and then press **OK** to print the fax.

---

### To set the paper size for received faxes from the control panel

1. Press **Setup**.
2. Press ▼ to highlight **Basic Fax Setup**, and then press **OK**.  
The **Basic Fax Setup** menu appears.
3. Press ▼ to highlight **Fax Paper Size**, and then press **OK**.  
The **Fax Paper Size** menu appears.
4. Press ▼ to highlight an option, and then press **OK**.

### Set up the HP All-in-One to check the paper type before printing faxes

By default, the HP All-in-One checks the paper type before printing a fax to ensure plain paper is loaded in the input tray. This prevents wasted paper and ink that might result

from printing faxes on photo or transparency paper left in the input tray from a previous job.

If you have plain paper loaded and the HP All-in-One is erroneously detecting your paper as a type other than plain, you can change the **Paper Checking** setting, so this detection does not take place before printing faxes.

---

 **NOTE:** The HP All-in-One always checks the paper size before printing faxes, regardless of the **Paper Checking** setting. This is to prevent ink from overprinting into the device if a full-size fax was printed on small-size paper.

---

#### To turn off paper checking from the control panel

1. Press **Setup**.
2. Press ▼ to highlight **Basic Fax Setup**, and then press **OK**.
3. Press ▼ to highlight **Paper Checking**, and then press **OK**.
4. Press ▼ to highlight **Off**, and then press **OK**.

### Set automatic reduction for incoming faxes

The **Automatic Reduction** setting determines what the HP All-in-One does if it receives a fax that is too large for the default paper size. This setting is turned on by default, so the image of the incoming fax is reduced to fit on one page, if possible. If this feature is turned off, information that does not fit on the first page is printed on a second page.

**Automatic Reduction** is useful when you receive a legal-size fax and letter-size paper is loaded in the input tray.

#### To set automatic reduction from the control panel

1. Press **Setup**.
2. Press ▼ to highlight **Advanced Fax Setup**, and then press **OK**.  
The **Advanced Fax Setup** menu appears.
3. Press ▼ to highlight **Automatic Reduction**, and then press **OK**.  
The **Automatic Reduction** menu appears.
4. Press ▼ to highlight **Off** or **On**.
5. Press **OK**.

### Block junk fax numbers

If you subscribe to a caller ID service through your phone provider, you can block specific fax numbers, so the HP All-in-One does not print faxes received from those numbers in the future. When an incoming fax call is received, the HP All-in-One compares the number to the list of junk fax numbers you set up to determine if the call should be blocked. If the number matches a number in the blocked fax numbers list, the fax is not printed. (The maximum number of fax numbers you can block varies by model.)

This section contains the following topics:

- [Set the junk fax mode](#)
- [Add numbers to the junk fax list](#)
- [Remove numbers from the junk fax list](#)



**NOTE:** This feature is not supported in all countries/regions. If it is not supported in your country/region, **Junk Fax Blocker Set Up** does not appear in the **Basic Fax Setup** menu.

### Set the junk fax mode

By default, **Block Junk Fax** mode is turned **On**. If you do not subscribe to a caller ID service through your phone provider, or do not want to use this feature, you can turn off this setting.

#### To set the junk fax mode

1. Press **Setup**.
2. Press ▼ to highlight **Basic Fax Setup**, and then press **OK**.  
The **Basic Fax Setup** menu appears.
3. Press ▼ to highlight **Junk Fax Blocker Set Up**, and then press **OK**.  
The **Junk Fax Blocker Set Up** menu appears.
4. Press ▼ to highlight **Block Junk Fax**, and then press **OK**.
5. Press ▼ to highlight **On** or **Off**, and then press **OK**.

### Add numbers to the junk fax list

There are two ways to add a number to your junk list. You can select numbers from your caller ID history, or you can enter new numbers. The numbers in your junk list will be blocked if **Block Junk Fax** mode is set to **On**.

#### To select a number from the caller ID list

1. Press **Setup**.
2. Press ▼ to highlight **Basic Fax Setup**, and then press **OK**.  
The **Basic Fax Setup** menu appears.
3. Press ▼ to highlight **Junk Fax Blocker Set Up**, and then press **OK**.  
The **Junk Fax Blocker** menu appears.
4. Press ▼ to highlight **Add number to Junk List**, and then press **OK**.  
The **How to Add** menu appears.
5. Press ▼ to highlight **Select number from Caller ID history**, and then press **OK**.  
The **Add Numbers** menu appears.
6. Press ▼ to scroll through the numbers from which you have received faxes. When the number you want to block is highlighted, press **OK** to select it.
7. When the **Junk Fax Blocker** prompt appears, do one of the following:
  - **If you want to add another number to the list of junk fax numbers**, repeat steps 4 through 6.
  - **If you are done**, press **Back**.

#### To manually enter a number to block

1. Press **Setup**.
2. Press ▼ to highlight **Basic Fax Setup**, and then press **OK**.  
The **Basic Fax Setup** menu appears.

3. Press ▼ to highlight **Junk Fax Blocker Set Up**, and then press **OK**.  
The **Junk Fax Blocker** menu appears.
4. Press ▼ to highlight **Add number to Junk List**, and then press **OK**.  
The **How to Add** menu appears.
5. Press ▼ to highlight **Enter new number**, and then press **OK**.  
The **Enter Junk Number** menu appears.
6. Use the keypad to enter a fax number to block, and then press **OK**.  
Make sure you accurately enter the caller ID of the number you want to block. On many junk faxes, the number that is printed in the fax header is different than the actual caller ID number.
7. When the **Junk Fax Blocker** prompt appears, do one of the following:
  - **If you want to add another number to the list of junk fax numbers**, repeat steps 4 through 6.
  - **If you are done**, press **Back**.

### Remove numbers from the junk fax list

If you no longer want to block a fax number, you can remove a number from your junk fax list.

#### To remove a number from the junk fax list

1. Press **Setup**.
2. Press ▼ to highlight **Basic Fax Setup**, and then press **OK**.  
The **Basic Fax Setup** menu appears.
3. Press ▼ to highlight **Junk Fax Blocker Set Up**, and then press **OK**.  
The **Junk Fax Blocker** menu appears.
4. Press ▼ to highlight **Remove from Junk List**, and then press **OK**.  
The **Remove Numbers** menu appears.
5. Press ▼ to scroll through the numbers you have blocked. When the number you want to remove is highlighted, press **OK** to select it.

## Fax over the Internet using IP phone

You might subscribe to a low-cost phone service that allows you to send and receive faxes with the HP All-in-One by using the Internet. This method is called Fax over Internet Protocol (FoIP). You probably use a FoIP service (provided by your telephone company) if you:

- Dial a special access code along with the fax number, or
- Have an IP converter box that connects to the Internet and provides analog phone ports for the fax connection.

---

 **NOTE:** You can only send and receive faxes by connecting a phone cord to the 1-LINE port on the back of the HP All-in-One, not by connecting the phone cord to the Ethernet port. This means that your connection to the Internet must be done either through a converter box (which supplies regular analog phone jacks for fax connections) or your telephone company.

---

The FoIP service might not work properly when the HP All-in-One is sending and receiving faxes at high speed (33600 bps). If you experience problems sending and receiving faxes,

use a slower fax speed. You can do this by changing the **Fax Speed** setting from **Fast (33600)** (the default) to **Medium (14400)**.

You should also check with your telephone company to make sure their Internet phone service supports faxing. If they do not support faxing, you might encounter intermittent problems when trying to send and receive faxes through the Internet.

### Related topics

[“Set the fax speed” on page 30](#)

## Stop faxing

You can cancel a fax you are sending or receiving at any time.

### To stop faxing from the control panel

- ▲ Press **Cancel** on the control panel to stop a fax you are sending or receiving. If the HP All-in-One does not stop faxing, press **Cancel** again.  
The HP All-in-One prints any pages it has already started printing and then cancels the remainder of the fax. This can take a few moments.

### To cancel a number you are dialing

- ▲ Press **Cancel** to cancel a number you are currently dialing.

# 12 Print reports and forms

The HP All-in-One enables you to print reports and to control when reports are printed automatically. You can also print forms such as ruled papers and checklists.

This section contains the following topics:

- [Print reports](#)
- [Print forms](#)

## Print reports

The HP All-in-One allows you to print reports and to control when reports are printed automatically. Use the reporting features to print self-test reports and fax reports.

---

 **NOTE:** Some reports might not be available in your country/region.

---

This section contains the following topics:

- [Print a self-test report](#)
- [Print fax reports](#)

### Print a self-test report

If you are experiencing problems with printing, print a self-test report before you replace the ink cartridges. This report provides useful information on several aspects of your device, including your ink cartridges.

#### To print a self-test report

1. Load letter, A4, or legal unused plain white paper into the input tray.
2. Press **Setup**.
3. Press ▼ to highlight **Print Report**, and then press **OK**.
4. Press ▼ to highlight **Self-Test Report**, and then press **OK**.

The HP All-in-One prints a self-test report, which contains the following information:

- **Product information:** includes the model number, serial number, and other product information.
- **Revision information:** includes the firmware version number.
- **Ink delivery system information:** displays the approximate ink level of each installed ink cartridge, the status of each ink cartridge, the date each cartridge was installed, and the date each cartridge will expire.
- **Print quality pattern:** displays six color blocks, representing each of the six installed cartridges. Solid, even blocks of color indicate there are no print quality problems. When streaks are displayed or there are missing blocks, clean the print head using the procedure described in [“Clean the print head” on page 162](#). If the color blocks still show print quality problems after cleaning the print head, align the printer using the procedure described in [“Align the printer” on page 161](#). If

the color blocks continue to show print quality problems after cleaning and aligning, contact HP support.

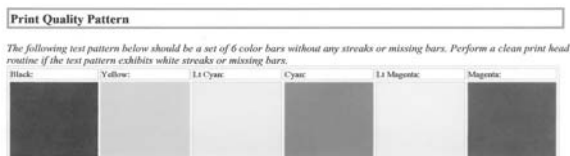

- **Bluetooth information:** lists the settings for the optional Bluetooth device.
- **History log:** contains information that might be used for diagnostic purposes if you need to call HP support.

## Print fax reports

You can set up the HP All-in-One to print error reports and confirmation reports automatically for each fax you send and receive. You can also manually print system reports as you need them; these reports provide useful system information about the HP All-in-One.

By default, the HP All-in-One is set to print a report only if there is a problem with sending or receiving a fax. A confirmation message that indicates whether a fax was successfully sent appears briefly on the display after each transaction.

This section contains the following topics:

- [Print fax confirmation reports](#)
- [Print fax error reports](#)
- [Print the fax log](#)
- [Print other reports](#)

### Print fax confirmation reports

If you need printed confirmation that your faxes were successfully sent, follow these instructions to enable fax confirmation **before** sending any faxes. Select either **On Fax Send** or **Send & Receive**.

The default fax confirmation setting is **Off**. This means that the HP All-in-One will not print a confirmation report for each fax sent or received. A confirmation message indicating whether a fax was successfully sent appears briefly on the display after each transaction.

#### To enable fax confirmation from the control panel

1. Press **Setup**.
2. Press ▼ to highlight **Print Report**, and then press **OK**.  
The **Print Report** menu appears.

3. Press ▼ to highlight **Fax Confirmation**, and then press **OK**.
4. Press ▼ to select one of the following, and then press **OK**.

<b>Off</b>	Does not print a fax confirmation report when you send and receive faxes successfully. This is the default setting.
<b>On Fax Send</b>	Prints a fax confirmation report for every fax you send.
<b>On Fax Receive</b>	Prints a fax confirmation report for every fax you receive.
<b>Send &amp; Receive</b>	Prints a fax confirmation report for every fax you send and receive.

 **TIP:** If you choose **On Fax Send** or **Send & Receive**, and scan your fax to send from memory, you can include an image of the first page of the fax on the **Fax Sent Confirmation** report. Press ▼ to highlight **Image on Fax Send Report**. Select **On** from the **Image on Fax Send Report** menu.

### Print fax error reports

You can configure the HP All-in-One so that it automatically prints a report when there is an error during transmission or reception.

#### To set the HP All-in-One to print fax error reports automatically

1. Press **Setup**.
2. Press ▼ to highlight **Print Report**, and then press **OK**.  
The **Print Report** menu appears.
3. Press ▼ to highlight **Fax Error Report**, and then press **OK**.
4. Press ▼ to select one of the following, and then press **OK**.

<b>Send &amp; Receive</b>	Prints whenever there is any kind of fax error. This is the default setting.
<b>Off</b>	Does not print any fax error reports.
<b>On Fax Send</b>	Prints whenever there is a transmission error.
<b>On Fax Receive</b>	Prints whenever there is a receiving error.

### Print the fax log

The fax log enables you to print a log of approximately the last 30 fax transactions. If a fax transaction had an error, the error is indicated by an error code in the fax log.

If necessary (for security purposes, for example), you can easily clear the entire log from memory. This also deletes any saved faxes from memory.

#### To print the fax log from the control panel

1. Press **Setup**.
2. Press ▼ to highlight **Print Report**, and then press **OK**.  
The **Print Report** menu appears.
3. Press ▼ to highlight **Fax Log**, and then press **OK** to print the **Fax Log**.



### To clear the fax log from memory

1. Press **Setup**.
2. Press ▼ to highlight **Tools**, and then press **OK**.  
The **Tools** menu appears.
3. Press ▼ to highlight **Clear Fax Log**, and then press **OK**.  
The fax log and any faxes that might have been stored in memory are deleted.

 **NOTE:** Clearing the fax log will not clear the caller ID history. To delete caller ID history, clear the fax log, then turn off the HP All-in-One, and then turn it back on.

### Related topics

[“The fax log report shows an error” on page 256](#)

### Print other reports

You can manually generate reports about the HP All-in-One, such as the status of the last fax you sent or a list of programmed speed dial entries.

### To print reports from the control panel

1. Press **Setup**.
2. Press ▼ to highlight **Print Report**, and then press **OK**.  
The **Print Report** menu appears.
3. Press ▼ to select one of the following, and then press **OK**.

<b>Fax Confirmation</b>	Lets you set up fax confirmation reports to print automatically.  <b>TIP:</b> If you choose <b>On Fax Send</b> or <b>Send &amp; Receive</b> , and scan your fax to send from memory, you can include an image of the first page of the fax on the <b>Fax Sent Confirmation</b> report. Press ▼ to highlight <b>Image on Fax Send Report</b> . Select <b>On</b> from the <b>Image on Fax Send Report</b> menu.
<b>Fax Error Report</b>	Lets you set up fax error reports to print automatically.
<b>Image on Fax Send Report</b>	If you choose <b>On Fax Send</b> or <b>Send &amp; Receive</b> , and scan your fax to send from memory, you can include an image of the first page of the fax on the <b>Fax Sent Confirmation</b> report. Press ▼ to highlight <b>Image on Fax Send Report</b> . Select <b>On</b> from the <b>Image on Fax Send Report</b> menu.
<b>Last Transaction</b>	Prints details of the last fax transaction.
<b>Fax Log</b>	Prints summary of last fax transaction.
<b>Speed Dial List</b>	Prints a list of programmed speed dial entries. You can also print this report by selecting <b>Print Speed Dial List</b> from the <b>Speed Dial Setup</b> menu.
<b>Caller ID Report</b>	If you subscribe to a caller ID service through your phone provider, this report prints a list of approximately the last 30 fax calls you received. The report shows the phone number, date and time, and, depending on

	the format your phone provider uses to transmit caller ID information, might include the name of the sender.
	<b>NOTE:</b> This feature is not supported in all countries/regions. If it is not supported in your country/region, <b>Caller ID Report</b> does not appear in the <b>Print Report</b> menu.
<b>Junk Fax Report</b>	If you subscribe to a caller ID service through your phone provider, and have designated any numbers as junk fax numbers, this report prints a list of the phone numbers you have blocked. (The maximum number of fax numbers you can block varies by model.)
	<b>NOTE:</b> This feature is not supported in all countries/regions. If it is not supported in your country/region, <b>Junk Fax Report</b> does not appear in the <b>Print Report</b> menu.

### Related topics

- [“Print fax confirmation reports”](#) on page 150
- [“Print fax error reports”](#) on page 151
- [“Print the fax log”](#) on page 151
- [“Set up speed dialing”](#) on page 65
- [“Block junk fax numbers”](#) on page 145

## Print forms

The HP All-in-One contains built-in templates that enable you to print common forms, such as narrow or wide ruled notebook paper, graph paper, task checklists, and music sheets on plain letter- or A4-size paper.

### To print forms from the control panel

1. Make sure you have paper loaded in the input tray.
2. Press **Setup**.  
The **Setup** menu appears.
3. Press ▼ to highlight **Printable School Papers**, and then press **OK**.  
The **Printable School Papers** menu appears.
4. Press ▼ to highlight the form you want to print, and then press **OK**.
5. Press ▲ or ▼ to enter the number of pages you want to print, and then press **OK**.



# 13 Maintain the HP All-in-One

The HP All-in-One requires little maintenance. Sometimes you might want to clean the glass and lid backing to remove surface dust and ensure that your copies and scans remain clear. You will also need to replace ink cartridges, clean the print head assembly, or align the printer from time to time. This section provides instructions for keeping the HP All-in-One in top working condition. Perform these simple maintenance procedures as necessary.

This section contains the following topics:

- [Clean the HP All-in-One](#)
- [Check the estimated ink levels](#)
- [Work with ink cartridges](#)
- [Self-maintenance sounds](#)
- [Reduce energy consumption when the HP All-in-One is off](#)
- [Turn off the HP All-in-One](#)

## Clean the HP All-in-One

To ensure that your copies and scans remain clear, you might need to clean the glass and lid backing. You might also want to dust the exterior of the HP All-in-One.

---

 **TIP:** You can purchase an HP Cleaning Kit for Inkjet Printers and All-in-Ones (Q6260A) that provides everything needed to safely clean your HP device. For more information, go to: [www.hp.com/buy/supplies](http://www.hp.com/buy/supplies).

---

This section contains the following topics:

- [Clean the glass](#)
- [Clean the lid backing](#)
- [Clean the exterior](#)

## Clean the glass

Glass that is dirty from fingerprints, smudges, hair, and dust on the main glass surface slows down performance and affects the accuracy of features such as **Fit to Page**.

In addition to the main glass surface, you might also need to clean the small glass strip inside the automatic document feeder. Streaks can occur if the glass strip inside the automatic document feeder is dirty.

**To clean the glass**

1. Turn off the HP All-in-One, and raise the lid.
2. Clean the glass with a soft cloth or sponge slightly moistened with a nonabrasive glass cleaner.

---

△ **CAUTION:** Do not use abrasives, acetone, benzene, or carbon tetrachloride on the glass, since they can damage it. Do not place or spray liquid directly on the glass. The liquid might seep under the glass and damage the device.

---

3. Dry the glass with a dry, soft, lint-free cloth to prevent spotting.
4. Turn on the HP All-in-One.

**To clean the glass strip inside the automatic document feeder**

1. Turn off the HP All-in-One.
2. Lift the cover of the automatic document feeder.

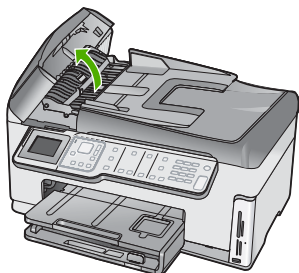

3. Lift the automatic document feeder mechanism.

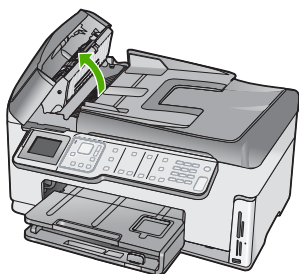

There is a glass strip under the automatic document feeder mechanism.

4. Clean the glass strip with a soft cloth or sponge slightly moistened with a nonabrasive glass cleaner.

---

△ **CAUTION:** Do not use abrasives, acetone, benzene, or carbon tetrachloride on the glass, since they can damage it. Do not place or spray liquid directly on the glass. The liquid might seep under the glass and damage the device.

---

5. Lower the automatic document feeder mechanism, and then close the cover of the automatic document feeder.
6. Turn on the HP All-in-One.

## Clean the lid backing

Minor debris can accumulate on the white document backing located underneath the lid of the HP All-in-One.

### To clean the lid backing

1. Turn off the HP All-in-One, and raise the lid.
2. Clean the white document backing with a soft cloth or sponge slightly moistened with a mild soap and warm water.  
Wash the backing gently to loosen debris. Do not scrub the backing.
3. Dry the backing with a dry, soft, lint-free cloth.

---

△ **CAUTION:** Do not use paper-based wipes, as these might scratch the backing.

---

4. If further cleaning is needed, repeat the previous steps using isopropyl (rubbing) alcohol, and wipe the backing thoroughly with a damp cloth to remove any residual alcohol.

---

△ **CAUTION:** Be careful not to spill alcohol on the glass or exterior of the HP All-in-One, as this might damage the device.

---

## Clean the exterior

Use a soft cloth or slightly moistened sponge to wipe dust, smudges, and stains off the case. The interior of the HP All-in-One does not require cleaning. Keep fluids away from the control panel and the interior of the HP All-in-One.

---

△ **CAUTION:** To avoid damage to the exterior of the HP All-in-One, do not use alcohol or alcohol-based cleaning products.

---

## Check the estimated ink levels

You can easily check the ink supply level to determine how soon you might need to replace an ink cartridge. The ink supply level shows an estimate of the amount of ink remaining in the ink cartridges.

 **NOTE:** The HP All-in-One can only detect the ink levels for genuine HP ink. The ink levels in ink cartridges that are refilled or have been used in other devices might not register accurately.

**NOTE:** Ink from the cartridges is used in the printing process in a number of different ways, including in the initialization process, which prepares the device and cartridges for printing, and in printhead servicing, which keeps print nozzles clear and ink flowing smoothly. In addition, some residual ink is left in the cartridge after it is used. For more information, see [www.hp.com/go/inkusage](http://www.hp.com/go/inkusage).

---

**To check the ink levels from the control panel**

1. Press **Setup**.
2. Press ▼ to highlight **Tools**, and then press **OK**.
3. Press ▼ to highlight **Display Ink Gauge**, and then press **OK**.  
The HP All-in-One displays a gauge that shows the estimated ink levels of all cartridges installed.



4. Press any button to return to the **Tools** menu.

**To check the ink levels from the HP Photosmart Software**

1. In the HP Solution Center, click **Settings**, point to **Print Settings**, and then click **Printer Toolbox**.

---

 **NOTE:** You can also open the **Printer Toolbox** from the **Print Properties** dialog box. In the **Print Properties** dialog box, click the **Services** tab, and then click **Service this device**.

---

The **Printer Toolbox** appears.

2. Click the **Estimated Ink Level** tab.  
The estimated ink levels for the ink cartridges appear.

---

 **TIP:** You can also print a self-test report to see if ink cartridges might need to be replaced.

---

**Related topics**

[“Print a self-test report” on page 149](#)

## Work with ink cartridges

To ensure the best print quality from the HP All-in-One, you will need to perform some simple maintenance procedures and, when prompted by a message on the display, replace the ink cartridges.

This section contains the following topics:

- [Replace the ink cartridges](#)
- [Align the printer](#)
- [Clean the print head](#)
- [Clean the ink cartridge contacts](#)
- [Remove ink from your skin and clothing](#)

## Replace the ink cartridges

Follow these instructions when you need to replace ink cartridges.

 **NOTE:** If you are installing ink cartridges in the HP All-in-One for the first time, be sure to use only the ink cartridges that came with the device. The ink in these cartridges is specially formulated to mix with the ink in the print head assembly at first-time setup.

If you do not already have replacement ink cartridges for the HP All-in-One, to order cartridges, go to [www.hp.com/buy/supplies](http://www.hp.com/buy/supplies). If prompted, choose your country/region, follow the prompts to select your product, and then click one of the shopping links on the page.

### To replace the ink cartridges

1. Make sure the HP All-in-One is turned on.
2. Open the ink cartridge door by lifting from the front center of the device, until the door locks into place.

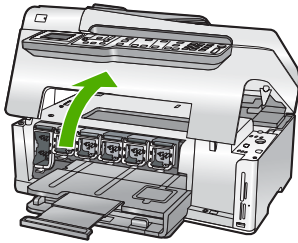

3. Squeeze the bottom of the latch below the ink cartridge you want to replace, and then lift the latch.  
If you are replacing the black ink cartridge, lift the latch on the far left.



If you are replacing one of the five color ink cartridges, such as yellow, light cyan (blue), cyan, light magenta (pink), or magenta, lift the appropriate latch in the center area.

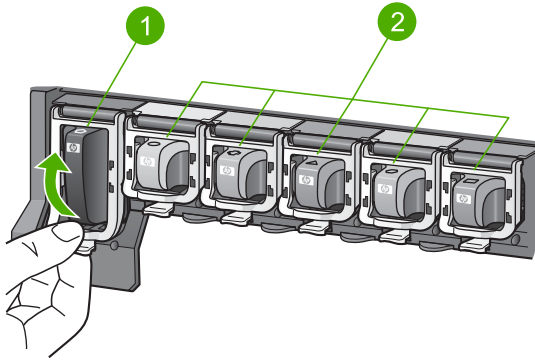

- |   |  |
|---|--|
| 1 | Ink cartridge latch for the black ink cartridge    |
| 2 | Ink cartridge latches for the color ink cartridges |

4. Pull the ink cartridge toward you out of its slot to remove it.

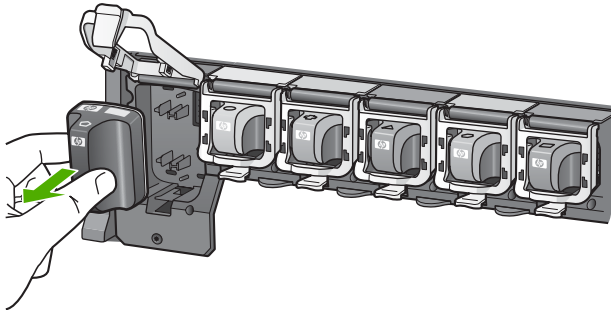

5. Remove the new ink cartridge from its packaging, and then, holding it by the handle, push the ink cartridge into the empty slot. Match the color and pattern of the ink cartridge to the color and pattern on the print carriage.

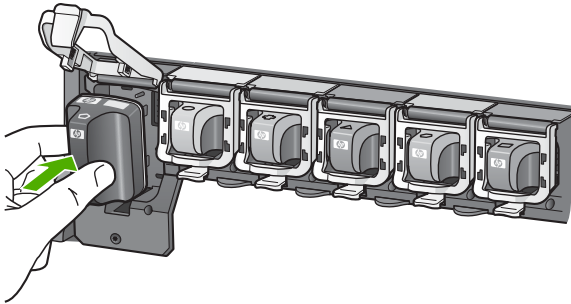

6. Close the latch and make sure it is secure.

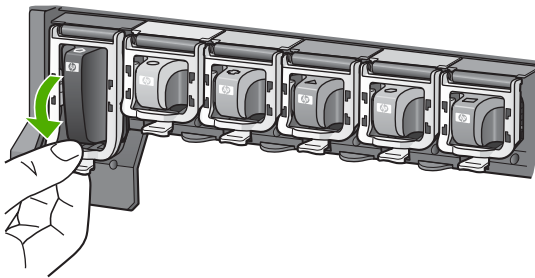

7. Repeat steps 3 through 6 for each ink cartridge you are replacing.
8. Close the ink cartridge door.

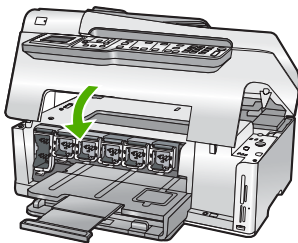

### Related topics

[“Shop for ink supplies” on page 167](#)

### Align the printer

The HP All-in-One automatically aligns the print head when you install the ink cartridges during the initial setup. The HP All-in-One also aligns the print head during periodic

maintenance to ensure excellent print quality. You might want to use this feature when the self-test report shows streaking or white lines through any of the blocks of color.

If you still have print quality problems after aligning the printer, try cleaning the print head. If print quality problems persist after aligning and cleaning, contact HP support.

### To align the printer from the control panel

1. Load letter, A4, or legal unused plain white paper into the input tray.
2. Press **Setup**.  
The **Setup** menu appears.
3. Press ▼ to highlight **Tools**, and press **OK**.  
The **Tools** menu appears.
4. Press ▼ to highlight **Align Printer**, and press **OK**.
5. The HP All-in-One prints a test page, aligns the print head, and calibrates the printer. Recycle or discard the page.  
A success or failure message appears.

---

 **NOTE:** If you have colored paper loaded in the input tray when you align the printer, the alignment will fail. Load unused plain white paper into the input tray, and then try the alignment again.

If the alignment fails again, you might have a defective sensor or ink cartridge. Contact HP support. Go to [www.hp.com/support](http://www.hp.com/support). If prompted, choose your country/region, and then click **Contact HP** for information on calling for technical support.

---

6. Press **OK** to continue.

### To align the printer from the HP Photosmart Software

1. Load letter, A4, or legal unused plain white paper into the input tray.
2. In the HP Solution Center, click **Settings**, point to **Print Settings**, and then click **Printer Toolbox**.

---

 **NOTE:** You can also open the **Printer Toolbox** from the **Print Properties** dialog box. In the **Print Properties** dialog box, click the **Services** tab, and then click **Service this device**.

---

The **Printer Toolbox** appears.

3. Click the **Device Services** tab.
4. Click **Align the Printer**.  
The HP All-in-One prints a test page, aligns the print head, and calibrates the printer. Recycle or discard the page.

### Related topics

[“Clean the print head” on page 162](#)

## Clean the print head

Use this feature when the self-test report shows streaking or white lines through any of the blocks of color. Do not clean the print head unnecessarily, as this wastes ink and shortens the life of the ink nozzles on the print head.

### To clean the print head from the control panel

1. Load letter or A4 unused plain white paper into the input tray.
2. Press **Setup**.
3. Press ▼ to highlight **Tools**, and then press **OK**.
4. Press ▼ to highlight **Clean Printhead**, and then press **OK**.  
The HP All-in-One cleans the print head and prints a page that you can recycle or discard.

### To clean the print head from the HP Photosmart Software

1. Load letter, A4, or legal unused plain white paper into the input tray.
2. In the HP Solution Center, click **Settings**, point to **Print Settings**, and then click **Printer Toolbox**.



**NOTE:** You can also open the **Printer Toolbox** from the **Print Properties** dialog box. In the **Print Properties** dialog box, click the **Services** tab, and then click **Service this device**.

The **Printer Toolbox** appears.

3. Click the **Device Services** tab.
4. Click **Clean the Print Head**.
5. Follow the prompts until you are satisfied with the quality of the output, and then click **Done**.

If print quality still seems poor after you clean the print head, try aligning the printer. If print quality problems persist after cleaning and aligning, contact HP support.

### Related topics

[“Align the printer” on page 161](#)

## Clean the ink cartridge contacts

Clean the copper-colored ink cartridge contacts if all ink cartridges are installed and a message appears on the display that says a cartridge is missing or damaged.

Before cleaning the ink cartridge contacts, remove the ink cartridge and verify that nothing is covering the ink cartridge contacts or the ink cartridge slot, then reinstall the ink cartridge. If you continue to get a message that says a cartridge is missing or damaged, clean the ink cartridge contacts. If you still get this message after cleaning the contacts, you will need a replacement ink cartridge. Remove the affected ink cartridge and look at the end-of-warranty date on the bottom. If it is before the end-of-warranty date, contact HP support to obtain a replacement ink cartridge.

Make sure you have the following materials available:

- Dry foam rubber swabs, lint-free cloth, or any soft material that will not come apart or leave fibers.
- Distilled, filtered, or bottled water (tap water might contain contaminants that can damage the ink cartridges).

△ **CAUTION:** Do **not** use platen cleaners or alcohol to clean the ink cartridge contacts. These can damage the ink cartridge or the HP All-in-One.

### To clean the ink cartridge contacts

1. Make sure the HP All-in-One is turned on.
2. Lift the ink cartridge door.
3. Squeeze the bottom of the latch below the ink cartridge you want to clean, and then lift the latch.

---

 **NOTE:** Do not remove multiple ink cartridges at the same time. Remove and clean each ink cartridge one at a time. Do not leave an ink cartridge outside the HP All-in-One for more than 30 minutes.

---

4. Inspect the ink cartridge contacts for ink and debris buildup.
5. Dip a clean foam rubber swab or lint-free cloth into distilled water, and squeeze any excess water from it.

---

 **NOTE:** Hold the ink cartridge by its handle. Do not touch the copper-colored contacts with your hands or anything other than a foam rubber swab or lint-free cloth.

---

6. Clean only the copper-colored contacts.

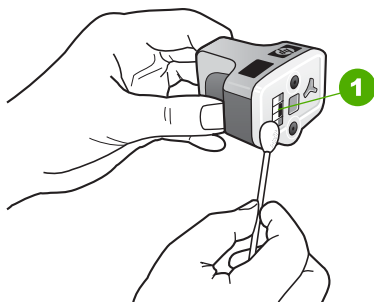

---

1 Copper-colored contacts

---

7. Place the ink cartridge back into the empty slot and press down on the gray latch until it clicks into place.
8. Repeat if necessary for the other ink cartridges.
9. Gently close the ink cartridge door.

### Remove ink from your skin and clothing

Follow these instructions to remove ink from your skin and clothing:

Surface	Remedy
Skin	Wash the area with an abrasive soap.
White fabric	Wash the fabric in <i>cold</i> water and use chlorine bleach.

(continued)

Surface	Remedy
Color fabric	Wash the fabric in <i>cold</i> water and use sudsy ammonia.

△ **CAUTION:** Always use cold water to remove ink from fabric. Warm or hot water can set the ink into the fabric.

## Self-maintenance sounds

The HP All-in-One will make mechanical noises at various times to perform periodic maintenance functions, such as replenishing the ink levels in the print head assembly or cleaning the print head. This is normal operation and is necessary to ensure the HP All-in-One produces the best quality printouts.

△ **CAUTION:** A message on the display will notify you when the HP All-in-One is performing maintenance functions. Do not remove power from the device during this time.

## Reduce energy consumption when the HP All-in-One is off

When the HP All-in-One is off, an amount of energy is still being consumed. Energy consumption can be lessened by enabling the Federal Energy Management Program (FEMP) mode.

 **NOTE:** When the HP All-in-One is in FEMP mode, it will take longer than usual to turn back on.

### To enable FEMP mode

▲ Press and hold the **On** button for 3 seconds until the HP All-in-One turns off.

## Turn off the HP All-in-One

To avoid damaging the HP All-in-One, you must properly shut it down by using the **On** button located on the device. Do not turn the HP All-in-One off by unplugging the power cord or turning off a power strip.



# 14 Shop for ink supplies

For a list of ink cartridge numbers, see the printed documentation that came with the HP All-in-One. You can also use the software that came with the HP All-in-One to find out the reorder number for all the ink cartridges. You can order ink cartridges online from the HP Web site. Additionally, you can contact a local HP reseller to find out the correct ink cartridge reorder numbers for your device and purchase ink cartridges.

To order genuine HP supplies for the HP All-in-One, go to [www.hp.com/buy/supplies](http://www.hp.com/buy/supplies). If prompted, choose your country/region, follow the prompts to select your product, and then click one of the shopping links on the page.

---

 **NOTE:** Ordering ink cartridges online is not supported in all countries/regions. If it is not supported in your country/region, contact a local HP reseller for information about purchasing ink cartridges.

---

## To order ink cartridges from your desktop

▲ Click the **Shop for HP Supplies** icon on your desktop to connect to HP SureSupply. You will see a list of original HP printing supplies that are compatible with your device, as well as options to conveniently purchase the supplies you need (options vary by country/region).

If you deleted this icon from your desktop, click the **Start** menu, point to the **HP** folder, then click **Shop for Supplies**.

## To order HP printing supplies through the HP Solution Center

1. In the HP Solution Center, click **Settings**, point to **Print Settings**, and then click **Printer Toolbox**.

---

 **NOTE:** You can also open the **Printer Toolbox** from the **Print Properties** dialog box. In the **Print Properties** dialog box, click the **Services** tab, and then click **Service this device**.

---

2. Click the **Estimated Ink Levels** tab.

3. Click **Ink Cartridge Ordering Information**.

The ink cartridge reorder numbers appear.

4. Click **Order Online**.

HP sends detailed printer information, including model number, serial number, and ink supply levels, to an authorized online reseller. The supplies you need are preselected; you can change quantities, add or remove items, and then check out.





# 15 Troubleshooting

This section contains the following topics:

- [Troubleshooting tips](#)
- [Hardware setup troubleshooting](#)
- [Software installation troubleshooting](#)
- [Network troubleshooting](#)
- [Print quality troubleshooting](#)
- [Print troubleshooting](#)
- [Memory card and front USB port troubleshooting](#)
- [Scan troubleshooting](#)
- [Copy troubleshooting](#)
- [Fax troubleshooting](#)
- [Errors](#)

## Troubleshooting tips

This section contains the following topics:

- [Communication problems over a USB connection](#)
- [Information on ink cartridges and the print head](#)
- [Information on paper](#)
- [Tips for using the automatic document feeder](#)
- [Clear paper jams](#)
- [Clean the automatic document feeder](#)

## Communication problems over a USB connection

 **NOTE:** For information on network communication problems, see [“Network troubleshooting”](#) on page 183. For information on communication problems involving a memory card, PictBridge camera, or storage device, see [“Memory card and front USB port troubleshooting”](#) on page 208.

If the HP All-in-One and computer are USB-connected and are not communicating with each other, try the following:

- Look at the display on the HP All-in-One. If the display is blank and the **On** button is not lit, the HP All-in-One is turned off. Make sure the power cord is firmly connected to the HP All-in-One and plugged into a power outlet. Press the **On** button to turn on the HP All-in-One.
- Check the USB cable. If you are using an older cable, it might not be working properly. Try connecting it to another product to see if the USB cable works. If you experience problems, the USB cable might need to be replaced. Also verify that the cable does not exceed 3 meters (9.8 feet) in length.
- Check the connection from the HP All-in-One to your computer. Verify that the USB cable is securely plugged into the USB port on the back of the HP All-in-One. Make

sure the other end of the USB cable is plugged into a USB port on your computer. After the cable is connected properly, turn the HP All-in-One off and then on again.

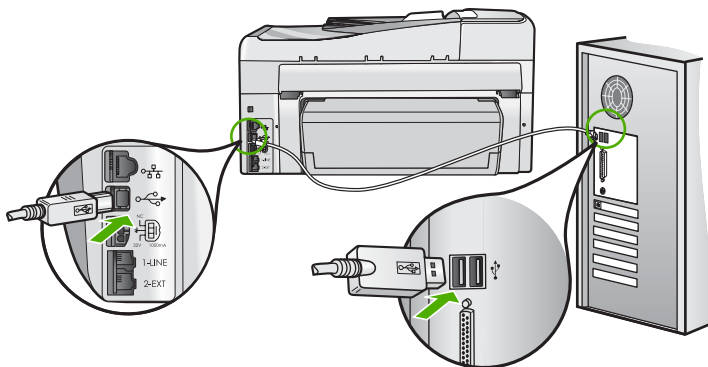

- If you are connecting the HP All-in-One through a USB hub, make sure the hub is turned on. If the hub is on, try connecting directly to your computer.
- Check other printers or scanners. You might need to disconnect older products from your computer.
- Try connecting the USB cable to another USB port on your computer. After you check the connections, try restarting your computer. Turn the HP All-in-One off and then on again.
- If necessary, remove the software you installed with the HP All-in-One and then install it again.

For more information, see:

[“Uninstall and reinstall the software” on page 181](#)

## Information on ink cartridges and the print head

The following tips help maintain HP ink cartridges and ensure consistent print quality.

- Install the ink cartridge on or before the install by date, which is printed on the ink cartridge package.
- Keep all ink cartridges in the original sealed packages until they are needed.
- Turn off the HP All-in-One by pressing the **On** button located on the device. Do not turn off the device by turning off a power strip or unplugging the power cord from the HP All-in-One. If you improperly turn off the HP All-in-One, the print head assembly might not return to the correct position.
- Store ink cartridges at room temperature (15.6°-26.6° C or 60°-78° F).
- HP recommends that you do not remove the ink cartridges from the HP All-in-One until you have replacement cartridges available to install.

If you are transporting the HP All-in-One make sure you turn off the device by pressing the **On** button to power it down properly. Also, make sure you leave the ink cartridges installed. Doing these actions will prevent ink leaking from the print head assembly.

- Clean the print head when you notice a significant decrease in print quality.

- Do not clean the print head unnecessarily. This wastes ink and shortens the life of the cartridges.
- Handle ink cartridges carefully. Dropping, jarring, or rough handling during installation can cause temporary printing problems.

## Information on paper

The HP All-in-One is designed to work well with most paper types. Test a variety of paper types before buying a large quantity. Find a paper type that works well and is easy to purchase. HP Premium papers are designed for the best quality results. In addition, follow these tips:

- Do not use paper that is too thin, that has a slick texture, or that stretches easily. It can feed incorrectly through the paper path, causing paper jams.
- Store photo media in its original packaging inside a resealable plastic bag on a flat surface in a cool, dry place. When you are ready to print, remove only the paper you plan to use immediately. When you have finished printing, return any unused photo paper to the plastic bag.
- Always hold photo paper by the edges. Fingerprints on photo paper can reduce print quality.
- Do not use paper that is heavily textured. It can cause graphics or text to print improperly.
- Do not combine different paper types and paper sizes in the input tray; the entire stack of paper in the input tray must be the same size and type.
- Store printed photos under glass or in a storage book to prevent bleeding over time from high humidity. Use HP Premium Plus photo paper for maximum performance.

## Tips for using the automatic document feeder

Follow these simple suggestions to avoid common problems when using the automatic document feeder.

- Remove any staples or clips from the original document.
- Make sure the paper is not too thick or too thin for the HP All-in-One to process.
- Do not overload the document feeder tray. The automatic document feeder can hold up to 50 sheets of letter or A4 paper, or 35 sheets of legal paper.
- Do not use spiral or frayed paper. If you must use paper that has been removed from a spiral binder, trim the edges.
- Do not load photos in the automatic document feeder. The automatic document feeder can damage photos. Always place photos on the glass to scan or copy.
- Make sure the paper-width guides in the document feeder tray fit snugly against the paper without bending the paper.
- Load your originals print side up into the document feeder tray.

## Clear paper jams

If the paper was loaded in the input tray, you might need to clear the paper jam from the rear of the HP All-in-One.

Paper can also jam in the automatic document feeder. Several common actions can cause paper to jam the automatic document feeder:

- Placing too much paper in the document feeder tray. The automatic document feeder can hold up to 50 sheets of letter or A4 paper, or 35 sheets of legal paper.
- Using paper that is too thick or too thin for the HP All-in-One.
- Trying to add paper to the document feeder tray while the HP All-in-One is feeding pages.

---

### To clear a paper jam from the Two-sided printing accessory

1. Turn off the HP All-in-One.
2. Press in the tabs on the left and right side of the Two-sided printing accessory. Remove the accessory by pulling it away from the HP All-in-One.

---

△ **CAUTION:** Trying to clear a paper jam from the front of the HP All-in-One can damage the print mechanism. Always access and clear paper jams from the Two-sided printing accessory of the HP All-in-One.

---

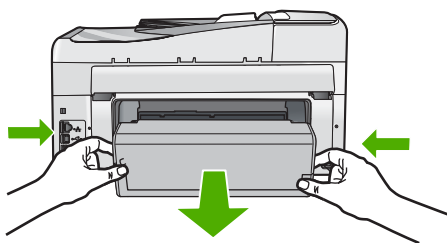

3. Gently pull the paper out of the rollers.

---

△ **CAUTION:** If the paper tears when you are removing it from the rollers, check the rollers and wheels for torn pieces of paper that might be remaining inside the device. If you do not remove all the pieces of paper from the HP All-in-One, more paper jams are likely to occur.

---

4. If the paper jam is cleared, proceed to step 5.  
If the paper jam is not cleared, do the following:
  - a. Open the Two-sided printing accessory by pulling the tabs up.
  - b. Remove any paper from inside the accessory.
  - c. Close the Two-sided printing accessory by pressing the tabs down until they lock into place.
5. Replace the Two-sided printing accessory. Gently push the accessory forward until it snaps into place.
6. Turn on the HP All-in-One, and then press **OK** to continue the current job.

## To clear a paper jam in the automatic document feeder

△ **CAUTION:** Do not lift the lid of the HP All-in-One and try to remove the jammed document from the glass. You might damage your original document.

1. Remove all originals from the document feeder tray.
2. Lift the cover of the automatic document feeder.

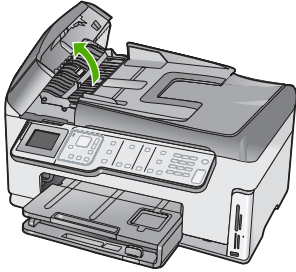

3. Lift the automatic document feeder mechanism.

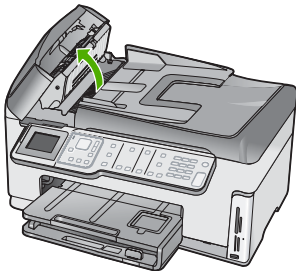

4. Gently pull out any paper that is jammed in the automatic document feeder mechanism.

△ **CAUTION:** If the paper tears when you are removing it, check for torn pieces of paper that might remain inside the mechanism. If you do not remove all the pieces of paper from the automatic document feeder, more paper jams are likely to occur.

5. Lower the automatic document feeder mechanism, and then close the cover of the automatic document feeder.  
The cover clicks when it is completely closed.

## Clean the automatic document feeder

If the automatic document feeder picks up multiple pages or if it does not pick up plain paper, you can clean the rollers and separator pad. Lift the automatic document feeder

cover to access the pick assembly inside the automatic document feeder, clean the rollers or separator pad, and then close the cover.

### To clean the rollers or separator pad

1. Remove all originals from the document feeder tray.
2. Lift the automatic document feeder cover.
 

This provides easy access to the rollers and separator pad, as shown below.

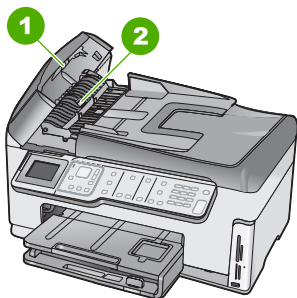

1	Rollers
2	Separator pad

3. Lightly dampen a clean lint-free cloth with distilled water, then squeeze any excess liquid from the cloth.
4. Use the damp cloth to wipe any residue off the rollers or separator pad.
5. Close the cover of the automatic document feeder.

## Hardware setup troubleshooting

This section contains hardware troubleshooting information for the HP All-in-One.

Many issues are caused when the HP All-in-One is connected to the computer using a USB cable before the HP All-in-One software is installed on the computer. If you connected the HP All-in-One to your computer before the software installation screen prompts you to do so, you must follow these steps:

### Troubleshooting common setup issues

1. Disconnect the USB cable from the computer.
2. Uninstall the software (if you have already installed it).
3. Restart your computer.
4. Turn off the HP All-in-One, wait one minute, then restart it.
5. Reinstall the HP All-in-One software.

---

△ **CAUTION:** Do not connect the USB cable to the computer until prompted by the software installation screen.

---

This section contains the following topics:

- [The HP All-in-One will not turn on](#)
- [I connected the USB cable, but I am having problems using the HP All-in-One with my computer](#)
- [The display shows the wrong language](#)
- [I received a message on the display that the printer alignment failed](#)
- [The wrong measurements are showing in menus on the display](#)
- [The HP All-in-One does not print](#)
- [I received a message on the display to install the Two-sided module](#)
- [I received a message on the display about a paper jam or a blocked print head assembly](#)

### The HP All-in-One will not turn on

**Cause:** The HP All-in-One is not properly connected to a power supply.

**Solution:**

- Make sure the power cord is firmly connected to both the HP All-in-One and the power adaptor. Plug the power cord into a grounded power outlet, surge protector, or power strip.

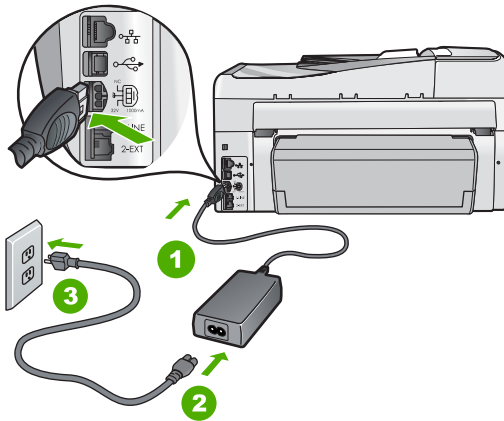

1	Power connection
2	Power cord and adaptor
3	Grounded power outlet

- If you are using a power strip, make sure the power strip is on. Or, try plugging the HP All-in-One directly into a grounded power outlet.



- Test the power outlet to make sure it is working. Plug in an appliance that you know works, and see if the appliance has power. If not, then there might be a problem with the power outlet.
- If you plugged the HP All-in-One into a switched outlet, make sure the switch is on. If it is switched to on but still does not work, then there might be a problem with the power outlet.

---

**Cause:** You pressed the **On** button too quickly.

**Solution:** The HP All-in-One might not respond if you press the **On** button too quickly. Press the **On** button once. It might take a few minutes for the HP All-in-One to turn on. If you press the **On** button again during this time, you might turn the device off.

---

⚠ **WARNING!** If the HP All-in-One still does not turn on, it might have a mechanical failure. Unplug the HP All-in-One from the power outlet and contact HP. Go to: [www.hp.com/support](http://www.hp.com/support)

If prompted, choose your country/region, and then click **Contact HP** for information on calling for technical support.

---

### I connected the USB cable, but I am having problems using the HP All-in-One with my computer

**Cause:** The USB cable was connected before the software was installed. Connecting the USB cable before prompted can cause errors.

**Solution:** You must first install the software that came with the HP All-in-One before connecting the USB cable. During installation, do not plug in the USB cable until prompted by the onscreen instructions.

Once you have installed the software, connecting your computer to the HP All-in-One with a USB cable is straightforward. Simply plug one end of the USB cable into the back of your computer and the other into the back of the HP All-in-One. You can connect to any USB port on the back of your computer.

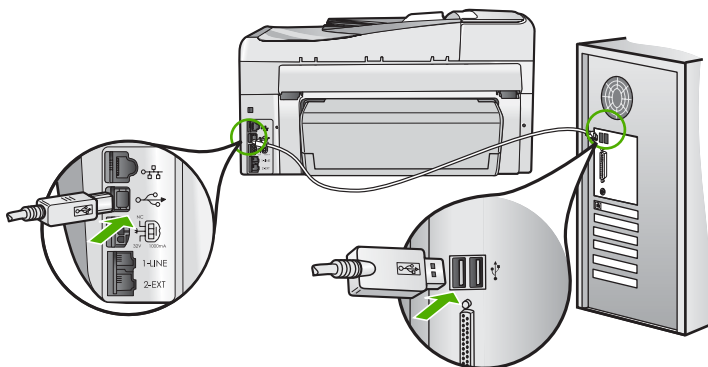

For more information on installing the software and connecting the USB cable, see the Setup Guide that came with the HP All-in-One.

---

### The display shows the wrong language

**Cause:** You might have selected the incorrect language when setting up the HP All-in-One.

**Solution:** You can change the language settings at any time from the **Preferences** menu.

For more information, see:

[“Set your language and country/region” on page 25](#)

---

### I received a message on the display that the printer alignment failed

**Cause:** The incorrect type of paper is loaded in the input tray (for example, colored paper, paper with text on it or, certain recycled paper).

**Solution:** Load unused plain white letter or A4 paper into the input tray, and then try the alignment again.

If the alignment fails again, you might have a defective sensor on the print head assembly. Contact HP support. Go to [www.hp.com/support](http://www.hp.com/support). If prompted, choose your country/region, and then click **Contact HP** for information on calling for technical support.

For more information, see:

[“Align the printer” on page 161](#)

---

### The wrong measurements are showing in menus on the display

**Cause:** You might have selected the incorrect country/region when setting up the HP All-in-One. The country/region you select determines the paper sizes shown on the display.

**Solution:** You can change the country/region settings from the **Preferences** menu.

For more information, see:

[“Set your language and country/region” on page 25](#)

---

### The HP All-in-One does not print

**Cause:** The HP All-in-One and computer are not communicating with each other.

**Solution:** Check the connection between the HP All-in-One and computer.

For more information, see:

[“Communication problems over a USB connection” on page 169](#)

---

**Cause:** There might be a problem with one or more of the ink cartridges.

**Solution:** Check that the ink cartridges are installed properly and have ink.

For more information, see:

[“Work with ink cartridges” on page 158](#)

---

**Cause:** The HP All-in-One might not be turned on.

**Solution:** Look at the display on the HP All-in-One. If the display is blank and the **On** button is not lit, the HP All-in-One is turned off. Make sure the power cord is firmly connected to the HP All-in-One and plugged into a power outlet. Press the **On** button to turn on the HP All-in-One.

---

**Cause:** The HP All-in-One might be out of paper.

**Solution:** Load paper in the input tray.

For more information, see:

[“Load paper” on page 76](#)

---

### I received a message on the display to install the Two-sided module

**Cause:** The Two-sided printing accessory is not installed correctly.

**Solution:** If the Two-sided printing accessory is installed, remove it and reinstall it. To reinstall it, press the buttons on each side of the accessory and push it into the rear of the HP All-in-One until it clicks into place.

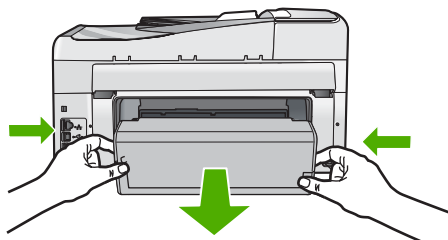

If the Two-sided printing accessory is not installed, install it at the rear of the HP All-in-One.

---

### I received a message on the display about a paper jam or a blocked print head assembly

**Cause:** The HP All-in-One has a paper jam.

**Solution:** Clear the paper jam, and then follow the prompts on the display or the computer screen to continue.

For more information, see:

[“Clear paper jams” on page 171](#)

---

**Cause:** The print head assembly is blocked.

**Solution:** There might be some packing material inside the HP All-in-One. Turn the HP All-in-One off and open the ink cartridge door. Remove any objects that are blocking the print head assembly (including any packing materials), and then turn the HP All-in-One on again. Follow the prompts on the display or the computer screen to continue.

---

## Software installation troubleshooting

Use this section to solve any problems you might encounter while setting up the HP All-in-One software.

This section contains the following topics:

- [When I insert the CD-ROM into my computer's CD-ROM drive, nothing happens](#)
- [The minimum system checks screen appears](#)
- [A red X appears on the USB connect prompt](#)
- [I received a message that an unknown error has occurred](#)
- [The registration screen does not appear](#)
- [Uninstall and reinstall the software](#)
- [Missing HP Photosmart Software](#)

### When I insert the CD-ROM into my computer's CD-ROM drive, nothing happens

**Cause:** The installation failed to run automatically.

**Solution:** If the installation does not run automatically, you can start it manually.

#### To start the installation from a Windows computer

1. From the Windows **Start** menu, click **Run** (or click **Accessories**, and then **Run**).
2. In the **Run** dialog box, enter **d:\setup.exe**, and then click **OK**.  
If your CD-ROM drive is not assigned to drive letter D, enter the appropriate drive letter.

---

### The minimum system checks screen appears

**Cause:** Your system does not meet the minimum requirements to install the software.

**Solution:** Click **Details** to see what the specific problem is, and then correct the problem before attempting to install the software.

---

### A red X appears on the USB connect prompt

**Cause:** Normally, a green check appears indicating that the usb connection is successful. A red X indicates that the usb connection failed.

**Solution:** Check that the HP All-in-One is turned on, and then try the usb connection again.

**To retry the usb connection**

1. Unplug the HP All-in-One power cord, and then plug it in again.
2. Verify that the USB cable and power cord are plugged in.

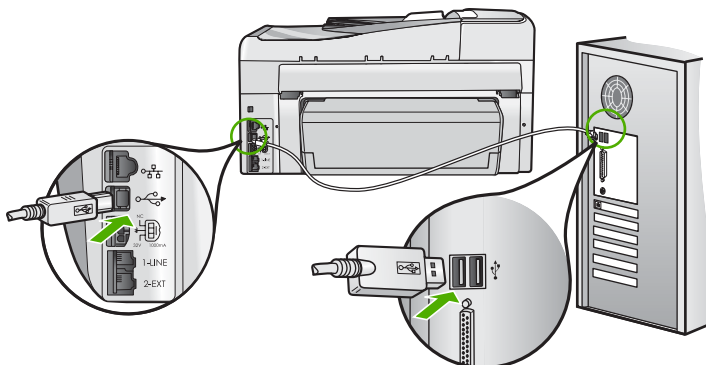

3. Click **Retry** to retry the connection. If this does not work, continue to the next step.
4. Verify that the USB cable is set up properly as follows:
  - Unplug the USB cable and plug it in again or try plugging the USB cable into a different USB port.
  - Do not attach the USB cable to a keyboard.
  - Verify that the USB cable is 3 meters (9.8 feet) or less in length.
  - If you have several USB devices attached to your computer, you might want to unplug the other devices during the installation.
5. Continue with the installation and restart the computer when prompted.

For more information, see:

[“Uninstall and reinstall the software” on page 181](#)

**I received a message that an unknown error has occurred**

**Cause:** The source of the error is unknown.

**Solution:** Try to continue with the installation. If that does not work, stop and then restart the installation, and follow the directions on the screen. If an error occurs, you might need to uninstall and then reinstall the software. Do not simply delete the HP All-in-One application files from your computer. Make sure to remove them properly using the uninstall utility provided when you installed the software that came with the HP All-in-One.

For more information, see:

[“Uninstall and reinstall the software” on page 181](#)

## The registration screen does not appear

**Cause:** The registration screen did not launch automatically.

**Solution:** You can access the registration (Sign up now) screen from the Windows taskbar by clicking **Start**, pointing to **Programs** or **All Programs, HP, Photosmart C7200 All-in-One series**, and then clicking **Product Registration**.

---

## Uninstall and reinstall the software

If your installation is incomplete, or if you connected the USB cable to the computer before prompted by the software installation screen, you might need to uninstall and then reinstall the software. Do not simply delete the HP All-in-One application files from your computer. Make sure to remove them properly using the uninstall utility provided when you installed the software that came with the HP All-in-One.

### To uninstall from a Windows computer, method 1

1. Disconnect the HP All-in-One from your computer. Do not connect the HP All-in-One to your computer until after you have reinstalled the software.
2. On the Windows taskbar, click **Start, Programs** or **All Programs, HP, Photosmart C7200 All-in-One series, Uninstall**.
3. Follow the onscreen instructions.
4. If you are asked whether you would like to remove shared files, click **No**. Other programs that use these files might not work properly if the files are deleted.
5. Restart your computer.

---

 **NOTE:** It is important that you disconnect the HP All-in-One before restarting your computer. Do not connect the HP All-in-One to your computer until after you have reinstalled the software.

---

6. To reinstall the software, insert the HP All-in-One CD-ROM into your computer's CD-ROM drive, and follow the onscreen instructions and the instructions provided in the Setup Guide that came with the HP All-in-One.
7. After the software is installed, connect the HP All-in-One to your computer.
8. Press the **On** button to turn the HP All-in-One on. After connecting and turning on the HP All-in-One, you might have to wait several minutes for all of the Plug and Play events to complete.
9. Follow the onscreen instructions.

### To uninstall from a Windows computer, method 2

---

 **NOTE:** Use this method if **Uninstall** is not available in the Windows Start menu.

---

1. On the Windows taskbar, click **Start, Settings, Control Panel** (or just **Control Panel**).
2. Double-click **Add/Remove Programs** (or click **Uninstall a program**).
3. Select **HP Photosmart All-In-One Driver Software**, and then click **Change/Remove**.  
Follow the onscreen instructions.

4. Disconnect the HP All-in-One from your computer.
5. Restart your computer.

---

 **NOTE:** It is important that you disconnect the HP All-in-One before restarting your computer. Do not connect the HP All-in-One to your computer until after you have reinstalled the software.

---

6. Insert the HP All-in-One CD-ROM into your computer's CD-ROM drive and then start the Setup program.
7. Follow the onscreen instructions and the instructions provided in the Setup Guide that came with the HP All-in-One.

### To uninstall from a Windows computer, method 3

---

 **NOTE:** Use this method if **Uninstall** is not available in the Windows Start menu.

---

1. Insert the HP All-in-One CD-ROM into your computer's CD-ROM drive and then start the Setup program.
2. Disconnect the HP All-in-One from your computer.
3. Select **Uninstall** and follow the onscreen directions.
4. Restart your computer.

---

 **NOTE:** It is important that you disconnect the HP All-in-One before restarting your computer. Do not connect the HP All-in-One to your computer until after you have reinstalled the software.

---

5. Start the Setup program for the HP All-in-One again.
6. Select **Install**.
7. Follow the onscreen instructions and the instructions provided in the Setup Guide that came with the HP All-in-One.

### Missing HP Photosmart Software

**Cause:** The HP Photosmart Software is not installed.

**Solution:** Install the HP Photosmart Software that came with the HP All-in-One. If it is installed, restart your computer.

#### To install the HP Photosmart Software

1. Insert the HP All-in-One CD-ROM into your computer's CD-ROM drive and then start the Setup program.
2. When prompted, click **Install More Software** to install the HP Photosmart Software.
3. Follow the onscreen instructions and the instructions provided in the Setup Guide that came with the HP All-in-One.

---

**Cause:** The HP All-in-One is turned off.

**Solution:** Turn the HP All-in-One on.

---

**Cause:** The computer is turned off.

**Solution:** Turn the computer on.

**Cause:** The HP All-in-One is not properly connected to the computer.

**Solution:** Check the connection from the HP All-in-One to your computer. Verify that the USB cable is securely plugged into the USB port on the back of the HP All-in-One. Make sure the other end of the USB cable is plugged into a USB port on your computer. After the cable is connected properly, turn the HP All-in-One off and then on again.

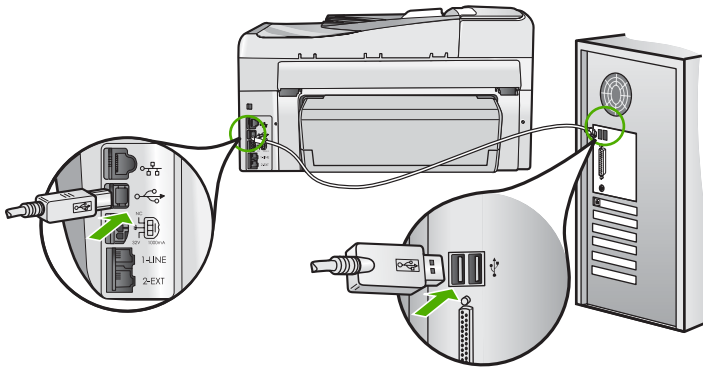

For more information on setting up the HP All-in-One and connecting it to your computer, see the Setup Guide that came with the HP All-in-One.

## Network troubleshooting

This section addresses problems you might encounter while setting up a network.

This section contains the following topics:

- [Wired network setup troubleshooting](#)
- [Wireless setup troubleshooting](#)

### Wired network setup troubleshooting

This section addresses problems you might encounter setting up a wired network.

This section contains the following topics:

- [The computer is unable to discover the HP All-in-One](#)
- [The Printer not Found screen appears during installation](#)

#### The computer is unable to discover the HP All-in-One

**Cause:** Cables are not connected properly.



**Solution:** Check the following cables to ensure they are connected properly.

- Cables between the HP All-in-One and the hub or router
- Cables between the hub or router and your computer
- Cables to and from your modem or HP All-in-One Internet connection (if applicable)

**Cause:** Your computer's Local Area Network card (LAN card) is not set up properly.

**Solution:** Make sure that your LAN card is set up properly.

#### To check your LAN card (Windows 2000 and XP)

1. Right-click **My Computer**.
2. In the **System Properties** dialog box, click the **Hardware** tab.
3. Click **Device Manager**.
4. Make sure your card shows up under **Network Adapters**.
5. Refer to the documentation that came with your card.

#### To check your LAN card (Windows Vista)

1. On the Windows taskbar, click **Start, Computer**, and then click **Properties**.
2. Click **Device Manager**.
3. Make sure your card shows up under **Network Adapters**.
4. Refer to the documentation that came with your card.

**Cause:** You do not have an active network connection.

**Solution:** Check to see if you have an active network connection.

#### To see if you have an active network connection

- ▲ Check the two Ethernet indicator lights on the top and bottom of the RJ-45 Ethernet jack on the back of the HP All-in-One. The lights indicate the following:
  - a. Top light: If this light is a solid green, the device is properly connected to the network, and communications have been established. If the top light is off, there is no network connection.
  - b. Bottom light: This yellow light flashes when data is being sent or received by the device over the network.

#### To establish an active network connection

1. Check the cable connections from the HP All-in-One to your gateway, router, or hub to ensure connections are secure.
2. If the connections are secure, turn off the power on the HP All-in-One, and then turn it on again. Press the **On** button on the control panel to turn the HP All-in-One off, and press it again to turn the device on. Also, turn off the power on your router or hub, and then turn it on again.

**Cause:** You were able to connect the HP All-in-One to the network previously, but now it will not connect.

**Solution:** Turn off the HP All-in-One, the computer, and the router. Wait 30 seconds. Turn on the router first, and then turn on the HP All-in-One and the computer.

---

**Cause:** The HP All-in-One and computer are not connected to the same network.

**Solution:** Try accessing the Embedded Web Server on the HP All-in-One. To find the IP address, print a network configuration page.

#### Related topics

- [“View and print network settings” on page 49](#)
  - [“Use the Embedded Web Server” on page 52](#)
- 

### The Printer not Found screen appears during installation

**Cause:** The HP All-in-One is not turned on.

**Solution:** Turn on the HP All-in-One.

---

**Cause:** You do not have an active network connection.

**Solution:** Make sure you have an active network connection.

#### To make sure your network connection is active

1. If the connections are secure, turn off the power on the HP All-in-One, and then turn it on again. Press the **On** button on the control panel to turn the HP All-in-One off, and press it again to turn the device on. Also, turn off the power on your router or hub, and then turn it on again.
  2. Check the cable connections from the HP All-in-One to your gateway, router, or hub to ensure connections are secure.
  3. Make sure the HP All-in-One is connected to the network with a CAT-5 Ethernet cable.
- 

**Cause:** Cables are not connected properly.

**Solution:** Check the following cables to ensure they are connected properly:

- Cables between the HP All-in-One and the hub or router
  - Cables between the hub or router and your computer
  - Cables to and from your modem or HP All-in-One Internet connection (if applicable)
- 

**Cause:** A firewall, anti-virus, or anti-spyware application is preventing the HP All-in-One from accessing your computer.

**Solution:** Uninstall the HP All-in-One software, and then reboot your computer. Temporarily disable anti-virus or anti-spyware applications, and then reinstall the HP All-in-One software. You can re-enable your anti-virus or anti-spyware applications after installation is complete. If you see firewall pop-up messages, you must always accept or allow the pop-up messages.

If the screen still appears, try uninstalling the HP All-in-One software, rebooting your computer, and temporarily disabling your firewall before reinstalling the HP All-in-One

software. You can re-enable your firewall application after installation is complete. If you still see firewall pop-up messages, you must always accept or allow the pop-up messages.

For more information, see the documentation provided with the firewall software.

---

**Cause:** A Virtual Private Network (VPN) is preventing the HP All-in-One from accessing your computer.

**Solution:** Try temporarily disabling the VPN before proceeding with the installation.

---

 **NOTE:** The HP All-in-One is not accessible during VPN sessions. However, print jobs are saved in the print queue. When you exit the VPN session, print jobs in the print queue will be printed.

---

## Wireless setup troubleshooting

This section addresses problems you might encounter setting up a network. Check the device display for specific error messages.

This section contains the following topics:

- [During wireless network setup you do not see the SSID \(network name\) displayed](#)
- [Weak signal](#)
- [Cannot connect to network during setup](#)
- [Invalid WEP key during wireless setup](#)
- [Invalid passphrase during wireless setup](#)
- [The Printer Not Found screen appears during installation](#)

### During wireless network setup you do not see the SSID (network name) displayed

**Cause:** Your wireless router is not broadcasting its network name (SSID) because the **Broadcast SSID** option is turned off.

**Solution:** Access the router's Embedded Web Server and turn on the **Broadcast SSID** option. See the user guide that came with your wireless router for information on how to access the Embedded Web Server and check the Broadcast SSID setting.

For more information, see:

[“Connect to an integrated wireless WLAN 802.11 network” on page 40](#)

---

**Cause:** The wireless router (infrastructure) or computer (ad hoc) is too far from the HP All-in-One or there is interference.

**Solution:** In order to establish a good signal between the HP All-in-One and wireless router (infrastructure) or computer (ad hoc), you might have to experiment a

bit. Assuming the equipment is functioning properly, try doing the following things separately or in combination:

- If there is a long distance between your computer or wireless router and the HP All-in-One, move them closer together.
- If there are metal objects (such as a metal bookcase or refrigerator) in the transmission path, clear the path between the HP All-in-One and the computer or wireless router.
- If a cordless telephone, microwave, or other device that emits radio signals transmitting at 2.4 GHz is nearby, move it farther away to reduce radio interference.
- If your computer or wireless router is near an external wall, move them away from the wall.

---

**Cause:** Your network name (SSID) may be at the bottom of the SSID list that is displayed when you install the HP All-in-One on a wireless network.

**Solution:** Press ▼ to scroll to the bottom of the list. Infrastructure entries are listed first, ad hoc last.

---

**Cause:** An Ethernet cable is connected to the HP All-in-One.

**Solution:** When an Ethernet cable is plugged into the HP All-in-One, the wireless radio turns off. Unplug the Ethernet cable.

---

### Weak signal

**Cause:** The HP All-in-One is too far away from the wireless router or there is interference.

**Solution:** In order to establish a good signal between the HP All-in-One and the wireless router, you might have to experiment a bit. Assuming the equipment is functioning properly, try doing the following things separately or in combination:

- If there is a long distance between your computer or wireless router and the HP All-in-One, move them closer together.
- If there are metal objects (such as a metal bookcase or refrigerator) in the transmission path, clear the path between the HP All-in-One and the computer or wireless router.
- If a cordless telephone, microwave, or other device that emits radio signals transmitting at 2.4 GHz is nearby, move it farther away to reduce radio interference.
- If your computer or wireless router is near an external wall, move them away from the wall.

---

### Cannot connect to network during setup

**Cause:** The equipment is not turned on.

**Solution:** Turn on the networked devices, such as the wireless router for an infrastructure network, or the computer for an ad hoc network. For more information

on how to turn on the wireless router, see the documentation that came with your wireless router.

---

**Cause:** The HP All-in-One is not receiving a signal.

**Solution:** Move the wireless router and the HP All-in-One closer together. Then run the wireless setup again.

For more information, see:

[“Integrated wireless WLAN 802.11 network setup” on page 39](#)

---

**Cause:** If you manually entered your network name (SSID), you might have entered it incorrectly.

**Solution:** Run the wireless setup process again and enter your network name (SSID) carefully. Remember that the SSID is case-sensitive.

For more information, see:

[“Connect to an integrated wireless WLAN 802.11 network” on page 40](#)

---

**Cause:** The setting for MAC address filtering might be enabled on your wireless router.

**Solution:** Disable MAC address filtering on your wireless router until the HP All-in-One has successfully connected to your network. If you re-enable MAC address filtering on your wireless router, make sure the MAC address of the HP All-in-One is on the list of acceptable MAC addresses.

---

### Invalid WEP key during wireless setup

**Cause:** If you are using WEP security, you might have entered the WEP key incorrectly during the wireless setup process.

**Solution:** During the wireless setup process, you might have entered the WEP key incorrectly. Some wireless routers provide up to four WEP keys. The HP All-in-One uses the first WEP key (selected by the wireless router as the default WEP key). Run the wireless setup process again and be sure to use the first WEP key provided by the wireless router. Enter the WEP key exactly as it appears in the wireless router settings. The WEP key is case sensitive.

If you do not know the WEP key, see the documentation that came with your wireless router for information on how to access the router's Embedded Web Server. You can find the WEP key by logging onto the router's Embedded Web Server using a computer on the wireless network.

---

### Invalid passphrase during wireless setup

**Cause:** During the wireless setup process, you might have entered the WPA passphrase incorrectly.

**Solution:** Run the wireless setup process again and enter the correct passphrase. The passphrase is case-sensitive.

---

### The Printer Not Found screen appears during installation

**Cause:** A firewall, anti-virus, or anti-spyware application is preventing the HP All-in-One from accessing your computer.

**Solution:** Uninstall the HP All-in-One software, and then reboot your computer. Temporarily disable anti-virus or anti-spyware applications, and then reinstall the HP All-in-One software. You can re-enable your anti-virus or anti-spyware applications after installation is complete. If you see firewall pop-up messages, you must always accept or allow the pop-up messages.

If the screen still appears, try uninstalling the HP All-in-One software, rebooting your computer, and temporarily disabling your firewall before reinstalling the HP All-in-One software. You can re-enable your firewall application after installation is complete. If you still see firewall pop-up messages, you must always accept or allow the pop-up messages.

For more information, see the documentation provided with the firewall software.

---

**Cause:** A Virtual Private Network (VPN) is preventing the HP All-in-One from accessing your computer.

**Solution:** Temporarily disable the VPN before proceeding with the installation.

---

 **NOTE:** The HP All-in-One functionality will be limited during VPN sessions.

---

**Cause:** The HP All-in-One is not turned on.

**Solution:** Turn on the HP All-in-One.

---

## Print quality troubleshooting

If you are having problems with print quality, try the solutions in this section and observe the following guidelines:

- Replace refilled or empty ink cartridges with genuine HP ink cartridges.
- Check the device settings to make sure that the print mode and paper selection is correct for the paper and the task.  
For more information, see [“Set the paper type for printing” on page 85](#) and [“Choose papers for printing and copying” on page 73](#).
- Print and evaluate a self-test report.  
For more information, see [“Print a self-test report” on page 149](#).

If the self-test report shows a defect, try the following:

- Clean the ink cartridges automatically. For more information, see [“Clean the print head” on page 162](#).
- If you are missing lines when you print, clean the electrical contacts. For more information, see [“Clean the ink cartridge contacts” on page 163](#).
- If the self-test report does not show a problem, investigate other causes, such as the image file or software program.

For additional ink cartridge troubleshooting, visit the HP Web site at [www.hp.com/support](http://www.hp.com/support).

This section contains the following topics:

- [Ink is bleeding or smearing](#)
- [The automatic document feeder picks up too many pages or none at all](#)
- [Ink is not filling the text or graphics completely](#)
- [The text edges are jagged](#)
- [The printout has a horizontal band of distortion near the bottom of the page](#)
- [Colors run into each other on the printout](#)
- [Printouts have horizontal streaks or lines](#)
- [Printouts are faded or have dull colors](#)
- [Printouts seem blurry or fuzzy](#)
- [Printouts have vertical streaks](#)
- [Printouts are slanted or skewed](#)
- [Ink is overspraying the paper when I print a photo](#)
- [Paper is not picked up from the input tray](#)
- [The print quality of the fax I received is poor](#)
- [Some of the pages of a fax I received are faded or blank](#)

### **Ink is bleeding or smearing**

**Cause:** The paper type is not suitable for the HP All-in-One.

**Solution:** Use HP Premium Papers or any other paper type that is appropriate for the HP All-in-One.

---

**Cause:** The print head needs to be cleaned.

**Solution:** Clean the print head, and then print a self-test report. Check the color blocks in the report for any problems. If the color blocks show print quality problems, perform a printer alignment.

If the problem persists after cleaning and aligning, contact HP support for help. Go to:

[www.hp.com/support](http://www.hp.com/support)

If prompted, choose your country/region, and then click **Contact HP** for information on calling for technical support.

For more information, see:

- [“Clean the print head” on page 162](#)
- [“Print a self-test report” on page 149](#)
- [“Align the printer” on page 161](#)

---

**Cause:** The paper is too close to the print head.

**Solution:** If the paper is too close to the print head during printing, the ink might be smeared. This can happen if the paper is raised, wrinkled, or very thick, such as a mailing envelope. Make sure the paper lays flat in the input tray and is not wrinkled.

---

### The automatic document feeder picks up too many pages or none at all

**Cause:** The separator pad or rollers inside the automatic document feeder might need to be cleaned. Pencil lead, wax, or ink can build up on the rollers and separator pad after extensive use, or if you copy handwritten originals or originals that are heavy with ink.

- If the automatic document feeder does not pick up any pages at all, the rollers inside the automatic document feeder need to be cleaned.
- If the automatic document feeder picks up multiple pages instead of single sheets, the separator pad inside the automatic document feeder needs to be cleaned.

**Solution:** Load one or two sheets of unused plain white full-size paper into the document feeder tray and press **Start Copy Black**. As the plain paper passes through the automatic document feeder, the paper releases and absorbs residue from the rollers and separator pad.

---

 **TIP:** If the automatic document feeder does not pick up the plain paper, try cleaning the front roller. Wipe the roller with a soft lint-free cloth dampened with distilled water.

---

If the problem persists, or the automatic document feeder does not pick up the plain paper, you can clean the rollers and separator pad manually.

For more information, see:

[“Clean the automatic document feeder” on page 173](#)

---

### Ink is not filling the text or graphics completely

**Cause:** The **Paper Type** setting is incorrect.

**Solution:** Change the **Paper Type** setting to match the type of paper loaded in the input tray.

For more information, see:

- [“Set the copy paper type” on page 123](#)
  - [“Set the paper type for printing” on page 85](#)
-



**Cause:** The copy or print paper type setting is incorrect.

**Solution:** Load high-quality paper in the input tray and print the image with a high print quality setting, such as **Best**, **Maximum dpi**, or **High Resolution**. Always make sure the paper you are printing on is flat. For best results when printing images, use HP Premium Plus Photo Paper.

If the problem persists, use the software you installed with the HP All-in-One or another software application to rotate your image 180 degrees so that the light blue, gray, or brown hues in your image do not print at the bottom of the page.

For more information, see:

[“Information on paper” on page 171](#)

---

**Cause:** The print head needs to be cleaned.

**Solution:** Clean the print head, and then print a self-test report. Check the color blocks in the report for any problems. If the color blocks show print quality problems, perform a printer alignment.

If the problem persists after cleaning and aligning, contact HP support for help. Go to:

[www.hp.com/support](http://www.hp.com/support)

If prompted, choose your country/region, and then click **Contact HP** for information on calling for technical support.

For more information, see:

- [“Clean the print head” on page 162](#)
  - [“Print a self-test report” on page 149](#)
  - [“Align the printer” on page 161](#)
- 

**Cause:** You are using non-HP ink.

**Solution:** HP recommends that you use genuine HP ink cartridges. Genuine HP ink cartridges are designed and tested with HP printers to help you easily produce great results, time after time.

 **NOTE:** HP cannot guarantee the quality or reliability of non-HP ink. Printer service or repairs required as a result of printer failure or damage attributable to the use of non-HP ink will not be covered under warranty.

---

### The text edges are jagged

**Cause:** The font is a custom size.

**Solution:** Some software applications offer custom fonts that have jagged edges when enlarged or printed. Also, if you want to print bitmapped text, it might have jagged edges when enlarged or printed.

Use TrueType or OpenType fonts to ensure that the HP All-in-One is able to print smooth fonts. When selecting a font, look for the TrueType or OpenType icon.

---

### The printout has a horizontal band of distortion near the bottom of the page

**Cause:** Your image has light blue, gray, or brown hues that print near the bottom of the page.

**Solution:** Load high-quality paper in the input tray and print the image with a high print quality setting, such as **Best**, **Maximum dpi**, or **High Resolution**. Always make sure the paper you are printing on is flat. For best results when printing images, use HP Premium Plus Photo Paper.

If the problem persists, use the software you installed with the HP All-in-One or another software application to rotate your image 180 degrees so that the light blue, gray, or brown hues in your image do not print at the bottom of the page.

For more information, see:

[“Information on paper” on page 171](#)

---

### Colors run into each other on the printout

**Cause:** The print or copy quality setting is set too high for the type of paper loaded in the HP All-in-One.

**Solution:** Check the quality setting. Use a lower quality setting to decrease the amount of ink used for printing or copying.

For more information, see:

- [“Change the print speed or quality” on page 86](#)
  - [“Change copy speed or quality” on page 124](#)
- 

**Cause:** The paper type is not suitable for the HP All-in-One.

**Solution:** Use HP Premium Papers or any other paper type that is appropriate for the HP All-in-One.

---

**Cause:** You are printing on the wrong side of the paper.

**Solution:** Load paper with the side you want to print on facing down. For example, if you are loading glossy photo paper, load the paper with the glossy side down.

For more information, see:

[“Load paper” on page 76](#)

---

**Cause:** You are using non-HP ink.

**Solution:** HP recommends that you use genuine HP ink cartridges. Genuine HP ink cartridges are designed and tested with HP printers to help you easily produce great results, time after time.

---

 **NOTE:** HP cannot guarantee the quality or reliability of non-HP ink. Printer service or repairs required as a result of printer failure or damage attributable to the use of non-HP ink will not be covered under warranty.

---

**Cause:** The print head needs to be cleaned.

**Solution:** Clean the print head, and then print a self-test report. Check the color blocks in the report for any problems. If the color blocks show print quality problems, perform a printer alignment.

If the problem persists after cleaning and aligning, contact HP support for help. Go to:

[www.hp.com/support](http://www.hp.com/support)

If prompted, choose your country/region, and then click **Contact HP** for information on calling for technical support.

For more information, see:

- [“Clean the print head” on page 162](#)
- [“Print a self-test report” on page 149](#)
- [“Align the printer” on page 161](#)

### Printouts have horizontal streaks or lines

**Cause:** The paper is not feeding properly or is loaded incorrectly.

**Solution:** Make sure the paper is loaded correctly.

For more information, see:

[“Load full-size paper” on page 76](#)

**Cause:** The copy or print paper type setting is incorrect.

**Solution:** Load high-quality paper in the input tray and print the image with a high print quality setting, such as **Best**, **Maximum dpi**, or **High Resolution**. Always make sure the paper you are printing on is flat. For best results when printing images, use HP Premium Plus Photo Paper.

If the problem persists, use the software you installed with the HP All-in-One or another software application to rotate your image 180 degrees so that the light blue, gray, or brown hues in your image do not print at the bottom of the page.

For more information, see:

[“Information on paper” on page 171](#)

**Cause:** The sending fax machine is having problems.

**Solution:** Ask the sender to check their fax machine for any problems.

**Cause:** The phone line connection is noisy. Phone lines with poor sound quality (noise) can cause print quality problems.

**Solution:** If the failure was due to noise on the phone line, contact the sender to have them resend the fax. The quality might be better when you try again. You can check the sound quality of the phone line by plugging a phone into the telephone wall jack and listening for static or other noise. If the problem persists, contact your telephone company.

**Cause:** The print head needs to be cleaned.

**Solution:** Clean the print head, and then print a self-test report. Check the color blocks in the report for any problems. If the color blocks show print quality problems, perform a printer alignment.

If the problem persists after cleaning and aligning, contact HP support for help. Go to:

[www.hp.com/support](http://www.hp.com/support)

If prompted, choose your country/region, and then click **Contact HP** for information on calling for technical support.

For more information, see:

- [“Clean the print head”](#) on page 162
- [“Print a self-test report”](#) on page 149
- [“Align the printer”](#) on page 161

---

### Printouts are faded or have dull colors

**Cause:** The copy or print paper type setting is incorrect.

**Solution:** Load high-quality paper in the input tray and print the image with a high print quality setting, such as **Best**, **Maximum dpi**, or **High Resolution**. Always make sure the paper you are printing on is flat. For best results when printing images, use HP Premium Plus Photo Paper.

If the problem persists, use the software you installed with the HP All-in-One or another software application to rotate your image 180 degrees so that the light blue, gray, or brown hues in your image do not print at the bottom of the page.

For more information, see:

[“Information on paper”](#) on page 171

---

**Cause:** The paper type is not suitable for the HP All-in-One.

**Solution:** Use HP Premium Papers or any other paper type that is appropriate for the HP All-in-One.

---

**Cause:** The **Lighter/Darker** copy setting for the HP All-in-One is set too light.

**Solution:** Adjust the lightness and darkness of the copies.

For more information, see:

[“Adjust the lightness and darkness of your copy”](#) on page 125

---

**Cause:** The **Paper Type** setting is incorrect.

**Solution:** Change the **Paper Type** setting to match the type of paper loaded in the input tray.

For more information, see:

- [“Set the copy paper type” on page 123](#)
- [“Set the paper type for printing” on page 85](#)

**Cause:** Copying a poor-quality picture, such as a newspaper photo, causes bands, checks, or stripes to appear on your copy. These are called moiré patterns.

**Solution:** To reduce moiré patterns, try placing one or more clear plastic sheet protectors directly on the glass, and then place the original print side down on top of the sheet protectors.

**Cause:** Debris might be stuck on the glass or on the back of the document lid; this causes poor copy quality and slows down processing.

**Solution:** Clean the glass and the back of the document lid.

For more information, see:

- [“Clean the glass” on page 155](#)
- [“Clean the lid backing” on page 157](#)

**Cause:** The print head needs to be cleaned.

**Solution:** Clean the print head, and then print a self-test report. Check the color blocks in the report for any problems. If the color blocks show print quality problems, perform a printer alignment.

If the problem persists after cleaning and aligning, contact HP support for help. Go to:

[www.hp.com/support](http://www.hp.com/support)

If prompted, choose your country/region, and then click **Contact HP** for information on calling for technical support.

For more information, see:

- [“Clean the print head” on page 162](#)
- [“Print a self-test report” on page 149](#)
- [“Align the printer” on page 161](#)

### Printouts seem blurry or fuzzy

**Cause:** The paper type is not suitable for the HP All-in-One.

**Solution:** Use HP Premium Papers or any other paper type that is appropriate for the HP All-in-One.

**Cause:** The **Paper Type** setting is incorrect.

**Solution:** Change the **Paper Type** setting to match the type of paper loaded in the input tray.

For more information, see:

- [“Set the copy paper type” on page 123](#)
- [“Set the paper type for printing” on page 85](#)

---

**Cause:** The copy or print paper type setting is incorrect.

**Solution:** Load high-quality paper in the input tray and print the image with a high print quality setting, such as **Best**, **Maximum dpi**, or **High Resolution**. Always make sure the paper you are printing on is flat. For best results when printing images, use HP Premium Plus Photo Paper.

If the problem persists, use the software you installed with the HP All-in-One or another software application to rotate your image 180 degrees so that the light blue, gray, or brown hues in your image do not print at the bottom of the page.

For more information, see:

[“Information on paper” on page 171](#)

---

**Cause:** You are printing on the wrong side of the paper.

**Solution:** Load paper with the side you want to print on facing down. For example, if you are loading glossy photo paper, load the paper with the glossy side down.

For more information, see:

[“Load paper” on page 76](#)

---

**Cause:** The fax sender is using a low resolution or the original was poor quality.

**Solution:** Ask the sender to increase the resolution and to verify the quality of the original.

---

### Printouts have vertical streaks

**Cause:** The paper type is not suitable for the HP All-in-One.

**Solution:** Use HP Premium Papers or any other paper type that is appropriate for the HP All-in-One.

---

**Cause:** The glass or automatic document feeder of the sending fax machine is dirty.

**Solution:** If you have vertical lines or streaks on the fax, the sender's fax machine might have dirt or dust on the glass or automatic document feeder. Check with the sender to see if the glass or automatic document feeder is clean.

---

### Printouts are slanted or skewed

**Cause:** The paper is not feeding properly or is loaded incorrectly.

**Solution:** Make sure the paper is loaded correctly.

For more information, see:

[“Load full-size paper” on page 76](#)

---

**Cause:** More than one type of paper is loaded in the input tray.

**Solution:** Load only one type of paper at a time.

---

**Cause:** The original might have been loaded incorrectly into the sending fax machine.

**Solution:** Ask the sender to check that the fax was sent correctly.

---

**Cause:** The Two-sided printing accessory might not be securely installed.

**Solution:** Make sure the Two-sided printing accessory on the back of the HP All-in-One is securely installed.

---

### Ink is overspraying the paper when I print a photo

**Cause:** A small amount (a few millimeters) of overspray is common when making a copy of a photo. If there are more than a few millimeters of overspray, it might mean the HP All-in-One thinks the paper loaded is wider than it actually is.

 **TIP:** One way to tell if ink is overspraying the paper is to check the back side of pages you print after running a copy or print job. If the back side of the page has ink streaks, the HP All-in-One might have over sprayed your previous copy or print job.

---

**Solution:** Check the paper size setting. Set the paper size to match the paper loaded in the input tray.

For more information, see:

[“Set the copy paper size” on page 122](#)

---

### Paper is not picked up from the input tray

**Cause:** There is not enough paper in the input tray.

**Solution:** If the HP All-in-One is out of paper or there are only a few sheets remaining, load more paper in the input tray. If there is paper in the input tray, remove the paper, tap the stack of paper against a flat surface, and reload the paper into the input tray. Follow the prompts on the display or the computer screen to continue your print job.

For more information, see:

[“Load paper” on page 76](#)

---

## The print quality of the fax I received is poor

**Cause:** The phone line connection is noisy. Phone lines with poor sound quality (noise) can cause print quality problems.

**Solution:** If the failure was due to noise on the phone line, contact the sender to have them resend the fax. The quality might be better when you try again. You can check the sound quality of the phone line by plugging a phone into the telephone wall jack and listening for static or other noise. If the problem persists, contact your telephone company.

---

**Cause:** The sending fax machine is having problems.

**Solution:** Ask the sender to check their fax machine for any problems.

---

**Cause:** The glass or automatic document feeder of the sending fax machine is dirty.

**Solution:** If you have vertical lines or streaks on the fax, the sender's fax machine might have dirt or dust on the glass or automatic document feeder. Check with the sender to see if the glass or automatic document feeder is clean.

---

**Cause:** The print head needs to be cleaned.

**Solution:** Clean the print head, and then print a self-test report. Check the color blocks in the report for any problems. If the color blocks show print quality problems, perform a printer alignment.

If the problem persists after cleaning and aligning, contact HP support for help. Go to:

[www.hp.com/support](http://www.hp.com/support)

If prompted, choose your country/region, and then click **Contact HP** for information on calling for technical support.

For more information, see:

- [“Clean the print head” on page 162](#)
  - [“Print a self-test report” on page 149](#)
  - [“Align the printer” on page 161](#)
- 

## Some of the pages of a fax I received are faded or blank

**Cause:** The original might have been loaded incorrectly into the sending fax machine.

**Solution:** Ask the sender to check that the fax was sent correctly.

---

**Cause:** The HP All-in-One picked up two sheets of paper while printing the fax.

**Solution:** If the HP All-in-One has only a few sheets remaining, load more paper in the input tray. If there is plenty of paper in the input tray, remove the paper, tap the stack of paper against a flat surface, and reload the paper into the input tray.

---

**Cause:** The paper loaded in the input tray is not suitable for your fax.



**Solution:** If the paper you are using is too fibrous, the ink applied by the HP All-in-One might not fully cover the surface of the paper. Use HP Premium Papers or any other paper type that is appropriate for the HP All-in-One.

---

**Cause:** The print head needs to be cleaned.

**Solution:** Clean the print head, and then print a self-test report. Check the color blocks in the report for any problems. If the color blocks show print quality problems, perform a printer alignment.

If the problem persists after cleaning and aligning, contact HP support for help. Go to:

[www.hp.com/support](http://www.hp.com/support)

If prompted, choose your country/region, and then click **Contact HP** for information on calling for technical support.

For more information, see:

- [“Clean the print head”](#) on page 162
- [“Print a self-test report”](#) on page 149
- [“Align the printer”](#) on page 161

---

## Print troubleshooting

Use this section to solve these printing problems:

- [Envelopes print incorrectly](#)
- [Borderless printing produces unexpected results](#)
- [The HP All-in-One is not responding](#)
- [The HP All-in-One prints meaningless characters](#)
- [Nothing happens when I try to print](#)
- [The pages in my document came out in the wrong order](#)
- [The margins are not printing as expected](#)
- [Text or graphics are cut off at the edge of the page](#)
- [A blank page came out while printing](#)
- [Ink is spraying the inside of the HP All-in-One when I print a photo](#)
- [Option for automatic two-sided printing cannot be selected](#)

### Envelopes print incorrectly

**Cause:** A stack of envelopes is loaded incorrectly.

**Solution:** Remove all paper from the input tray. Load a stack of envelopes in the input tray, with the envelope flaps facing up and to the left.

---

 **NOTE:** To avoid paper jams, tuck the flaps inside the envelopes.

---

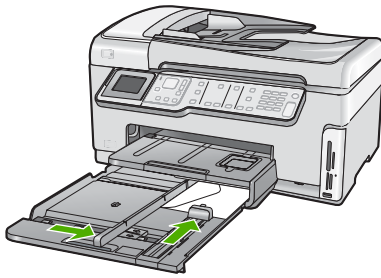

---

**Cause:** The wrong type of envelope is loaded.

**Solution:** Do not use shiny or embossed envelopes or envelopes that have clasps or windows.

---

### Borderless printing produces unexpected results

**Cause:** Printing a borderless image from a non-HP software application produces unexpected results.

**Solution:** Try printing the image from the photo imaging software that came with the HP All-in-One.

---

### The HP All-in-One is not responding

**Cause:** The Two-sided printing accessory is not installed correctly.

**Solution:** If the Two-sided printing accessory is installed, remove it and reinstall it. To reinstall it, press the buttons on each side of the accessory and push it into the rear of the HP All-in-One until it clicks into place.

If the Two-sided printing accessory is not installed, install it at the rear of the HP All-in-One.

---

**Cause:** The HP All-in-One is busy with another task.

**Solution:** If the HP All-in-One is performing another task such as copying or scanning, your print job will be delayed until the HP All-in-One completes the current task.

Some documents take a long time to print. If nothing has printed several minutes after you sent a print job to the HP All-in-One, check your computer to see if there are any messages.

---

**Cause:** The HP All-in-One has a paper jam.

**Solution:** Clear the paper jam.

For more information, see:

[“Clear paper jams” on page 171](#)

---

**Cause:** The HP All-in-One is out of paper.

**Solution:** Load paper in the input tray.

For more information, see:

[“Load paper” on page 76](#)

**Cause:** The print head assembly has stalled.

**Solution:** Turn the HP All-in-One off and open the ink cartridge door. Remove any objects that are blocking the print head assembly (including any packing materials), and then turn the HP All-in-One on again.

**Cause:** The computer is not communicating with the HP All-in-One.

**Solution:** If the HP All-in-One is not properly connected to the computer, communication errors can occur. Make sure the USB cable is connected to the HP All-in-One and the computer as shown below.

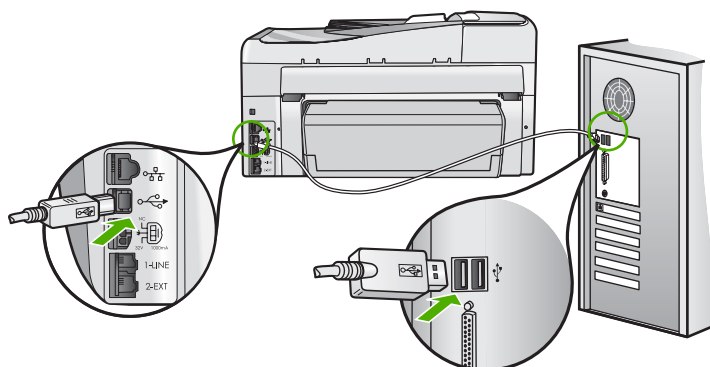

If the connections are secure, and nothing has printed several minutes after you sent a print job to the HP All-in-One, check the status of the HP All-in-One. In the HP Photosmart Software, click **Status**.

For more information, see:

[“I connected the USB cable, but I am having problems using the HP All-in-One with my computer” on page 176](#)

**Cause:** The HP All-in-One is turned off.

**Solution:** Look at the **On** button located on the top of the HP All-in-One. If it is not lit, the HP All-in-One is turned off. Make sure the power cord is firmly connected to the HP All-in-One and plugged into a power outlet. Press the **On** button to turn on the HP All-in-One.

**Cause:** The HP All-in-One experienced an error.

**Solution:** Turn the HP All-in-One off, and then unplug the power cord. Plug the power cord back in, and then press the **On** button to turn on the HP All-in-One.

**Cause:** The status of the printer driver has changed.

**Solution:** The printer driver status might have changed to either **offline** or **stop printing**.

#### To check the printer driver status

1. In the HP Solution Center, click the device tab.
2. Click **Settings**.
3. Click **Status**.

If the status is **offline** or **stop printing**, change the status to **ready**.

---

**Cause:** A deleted print job is still in the queue.

**Solution:** A print job might remain in the queue after it has been cancelled. The cancelled print job jams the queue and prevents the next print job from printing.

From your computer, open the printer folder and see if the cancelled job remains in the print queue. Try to delete the job from the queue. If the print job remains in the queue, try one or both of the following:

- Disconnect the USB cable from the HP All-in-One, restart the computer, and then reconnect the USB cable to the HP All-in-One.
  - Shut down the HP All-in-One, restart the computer, and then restart the HP All-in-One.
- 

### The HP All-in-One prints meaningless characters

**Cause:** There is no more available memory in the HP All-in-One.

**Solution:** Turn off the HP All-in-One and your computer for 60 seconds, then turn them both on and try printing again.

---

**Cause:** The document is corrupt.

**Solution:** Try printing another document from the same software application. If this works, then try printing a previously saved version of the document that is not corrupt.

---

### Nothing happens when I try to print

**Cause:** The HP All-in-One is turned off.

**Solution:** Look at the **On** button located on the top of the HP All-in-One. If it is not lit, the HP All-in-One is turned off. Make sure the power cord is firmly connected to the HP All-in-One and plugged into a power outlet. Press the **On** button to turn on the HP All-in-One.

---

**Cause:** The HP All-in-One is busy with another task.

**Solution:** If the HP All-in-One is performing another task such as copying or scanning, your print job will be delayed until the HP All-in-One completes the current task.

Some documents take a long time to print. If nothing has printed several minutes after you sent a print job to the HP All-in-One, check your computer to see if there are any messages.

---

**Cause:** The HP All-in-One is not the selected printer.

**Solution:** Make sure the HP All-in-One is the selected printer in your software application.

 **TIP:** You can set the HP All-in-One as the default printer to ensure that the printer is automatically selected when you select **Print** in the **File** menu of your different software applications.

---

**Cause:** The computer is not communicating with the HP All-in-One.

**Solution:** If the HP All-in-One is not properly connected to the computer, communication errors can occur. Make sure the USB cable is connected to the HP All-in-One and the computer as shown below.

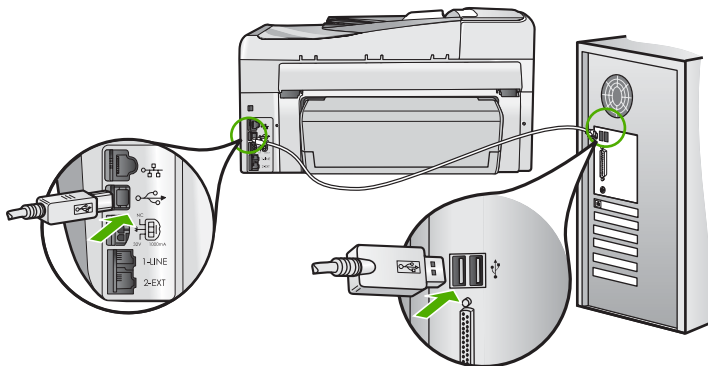

If the connections are secure, and nothing has printed several minutes after you sent a print job to the HP All-in-One, check the status of the HP All-in-One. In the HP Photosmart Software, click **Status**.

For more information, see:

[“I connected the USB cable, but I am having problems using the HP All-in-One with my computer” on page 176](#)

---

**Cause:** The HP All-in-One has a paper jam.

**Solution:** Clear the paper jam.

For more information, see:

[“Clear paper jams” on page 171](#)

---

**Cause:** The print head assembly has stalled.

**Solution:** Turn the HP All-in-One off and open the ink cartridge door. Remove any objects that are blocking the print head assembly (including any packing materials), and then turn the HP All-in-One on again.

---

**Cause:** The HP All-in-One is out of paper.

**Solution:** Load paper in the input tray.

For more information, see:

[“Load paper” on page 76](#)

---

### The pages in my document came out in the wrong order

**Cause:** The print settings are set to print the first page of your document first. Because of the way the paper feeds through the HP All-in-One, this means the first page will be print side up at the bottom of the stack.

**Solution:** Print the document in reverse order. When the document finishes printing, the pages will be in correct order.

For more information, see:

[“Print a multiple-page document in reverse order” on page 95](#)

---

### The margins are not printing as expected

**Cause:** The margins are not set correctly in your software application.

**Solution:** Check the printer margins.

Make sure the margin settings for the document do not exceed the printable area of the HP All-in-One.

#### To check your margin settings

1. Preview your print job before sending it to the HP All-in-One.
  2. Check the margins.  
The HP All-in-One uses the margins you have set in your software application, as long as they are greater than the minimum margins the HP All-in-One supports.
  3. Cancel the print job if the margins are not satisfactory, and then adjust the margins in your software application.
- 

**Cause:** The paper size setting might not be set correctly for the project you are printing.

**Solution:** Verify that you have selected the proper paper size setting for your project. Make sure that you have loaded the correct paper size in the input tray.

---

**Cause:** The paper guides are not positioned correctly.

**Solution:** Remove the stack of paper from the input tray, reload the paper, and then slide the paper width guide inward until it stops at the edge of the paper.

For more information, see:

[“Load paper” on page 76](#)

---

**Cause:** A stack of envelopes is loaded incorrectly.

**Solution:** Remove all paper from the input tray. Load a stack of envelopes in the input tray, with the envelope flaps facing up and on the left.

 **NOTE:** To avoid paper jams, tuck the flaps inside the envelopes.

---

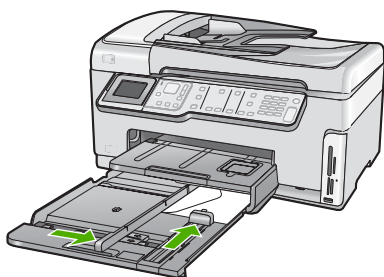

For more information, see:

[“Load envelopes” on page 80](#)

---

### Text or graphics are cut off at the edge of the page

**Cause:** The margins are not set correctly in your software application.

**Solution:**

#### To check your margin settings

1. Preview your print job before sending it to the HP All-in-One.
2. Check the margins.  
The HP All-in-One uses the margins you have set in your software application, as long as they are greater than the minimum margins the HP All-in-One supports.
3. Cancel the print job if the margins are not satisfactory, and then adjust the margins in your software application.

Make sure the margin settings for the document do not exceed the printable area of the HP All-in-One.

---

**Cause:** The size of the document you are printing is larger than the paper loaded in the input tray.

**Solution:** Make sure the layout of the document you are trying to print fits on a paper size supported by the HP All-in-One.

#### To preview the print layout

1. Load the correct paper size into the input tray.
2. Preview your print job before sending it to the HP All-in-One.
3. Check the graphics in the document to make sure that the current size fits within the printable area of the HP All-in-One.
4. Cancel the print job if the graphics do not fit in the printable area of the page.

 **TIP:** Some software applications allow you to scale the document to fit the paper size currently selected. Additionally, you can scale the size of a document from the print **Properties** dialog box.

---

**Cause:** The paper is loaded incorrectly.

**Solution:** If the paper is misfeeding, it could cause parts of the document to cut off. Remove the stack of paper from the input tray, and then reload the paper following the steps below.

For more information, see:

[“Load paper” on page 76](#)

---

#### A blank page came out while printing

**Cause:** The document you are printing contains an additional blank page.

**Solution:** Open the document file in your software application and remove any extra pages or lines at the end of the document.

---

**Cause:** The HP All-in-One picked up two sheets of paper.

**Solution:** If the HP All-in-One has only a few sheets remaining, load more paper in the input tray. If there is plenty of paper in the input tray, remove the paper, tap the stack of paper against a flat surface, and reload the paper into the input tray.

For more information, see:

[“Load paper” on page 76](#)

---

#### Ink is spraying the inside of the HP All-in-One when I print a photo

**Cause:** The borderless print settings require photo paper to be loaded in the input tray. You are using the wrong paper type.

**Solution:** Make sure you load photo paper in the input tray before you print a borderless print job.

---

#### Option for automatic two-sided printing cannot be selected

**Cause:** The Two-sided printing accessory is not installed or it is installed incorrectly.

---



**Solution:** Firmly insert the Two-sided printing accessory into the back of the device until both sides snap into place.

---

 **NOTE:** Do not press the buttons on either side of the accessory when installing it. Use the buttons only when removing the accessory from the device.

---

**Cause:** The selected paper type and paper size might not be supported by the Two-sided printing accessory.

**Solution:** Make sure the selected paper type and size are compatible with the Two-sided printing accessory. For more information, see [“Technical information” on page 287](#).

---

## Memory card and front USB port troubleshooting

Use this section to solve these memory card problems:

- [My memory card no longer works in my digital camera](#)
- [The HP All-in-One does not read the memory card or storage device](#)
- [The Photo light next to the memory card slots is blinking](#)
- [The Attention light blinks when I insert my memory card or storage device](#)
- [The photos on the memory card or storage device do not transfer to my computer](#)
- [Memory card or storage device is not available](#)
- [Photos in a connected digital camera with PictBridge do not print](#)
- [The file name appears as meaningless text](#)
- [Other users on the network can access my memory card or storage device](#)
- [Error message: Cannot find the file or item. Make sure the path and file name are correct.](#)

### My memory card no longer works in my digital camera

**Cause:** You formatted the card on a Windows XP computer. By default, Windows XP will format a memory card of 8 MB or less and 64 MB or more with the FAT32 format. Digital cameras and other devices use the FAT (FAT16 or FAT12) format and cannot recognize a FAT32 formatted card.

**Solution:** Reformat your memory card in your camera or format your memory card in a Windows XP computer by selecting the FAT format.

---

### The HP All-in-One does not read the memory card or storage device

**Cause:** The card is inserted backwards or upside down.

**Solution:** Turn the memory card so that the label side is on the left and the contacts are on the right (and facing the device), and then push the card forward into the appropriate slot until the Photo light turns on.

If the memory card is not inserted properly, the HP All-in-One will not respond and the Photo light (near the memory card slots) will not turn on.

After the memory card has been inserted properly, the Photo light will blink for a few seconds, and then remain lit.

---

**Cause:** The memory card or storage device is not fully inserted.

**Solution:** Make sure you fully insert the memory card into the appropriate slot on the HP All-in-One. Or, if you are using a storage device such as a keychain drive, make sure you fully insert the storage device into the front USB port.

If the memory card or storage device is not inserted properly, the HP All-in-One will not respond and the Photo light (near the memory card slots) will not turn on.

After a memory card or storage device has been inserted properly, the Photo light will blink for a few seconds, and then remain lit.

---

**Cause:** You have inserted more than one memory card, or you have inserted a memory card and a storage device at the same time.

**Solution:** If you have inserted more than one memory card, remove one of the memory cards. You can use only one memory card at a time.

If you have a memory card and a storage device connected, remove the storage device. You can use only one at a time.

---

**Cause:** The file system is corrupted.

**Solution:** Check the display for an error message telling you about the problem and how to solve it.

If the file system on the card is corrupt, reformat the memory card in your digital camera.

---

△ **CAUTION:** Reformatting the memory card will delete any photos stored on the card. If you have previously transferred the photos from your memory card to a computer, try printing the photos from the computer. Otherwise, you will need to retake any photos you might have lost.

---

### The Photo light next to the memory card slots is blinking

**Cause:** The HP All-in-One is reading the memory card.

**Solution:** Do not pull out the memory card while the Photo light is flashing. A flashing light means the HP All-in-One is accessing the memory card. Wait until the light remains solid. Removing a memory card while it is being accessed might corrupt information on the card or damage the HP All-in-One and card.

---

### The Attention light blinks when I insert my memory card or storage device

**Cause:** The HP All-in-One has detected an error with the memory card.

**Solution:** Remove and reinsert the memory card. You might have inserted it incorrectly. Turn the memory card so that the label side is on the left and the contacts

are on the right (and facing the device), and then push the card forward into the appropriate slot until the Photo light turns on.

If the problem continues, the memory card might be defective.

---

**Cause:** You have inserted more than one memory card, or you have an inserted a memory card and a storage device at the same time.

**Solution:** If you have inserted more than one memory card, remove one of the memory cards. You can use only one memory card at a time.

If you have a memory card and a storage device connected, remove either the memory card or the storage device. You can use only one at a time.

---

### The photos on the memory card or storage device do not transfer to my computer

**Cause:** The HP Photosmart Software is not installed.

**Solution:** Install the HP Photosmart Software that came with the HP All-in-One. If it is installed, restart your computer.

#### To install the HP Photosmart Software

1. Insert the HP All-in-One CD-ROM into your computer's CD-ROM drive and then start the Setup program.
  2. When prompted, click **Install More Software** to install the HP Photosmart Software.
  3. Follow the onscreen instructions and the instructions provided in the Setup Guide that came with the HP All-in-One.
- 

**Cause:** The HP All-in-One is turned off.

**Solution:** Turn the HP All-in-One on.

---

**Cause:** The computer is turned off.

**Solution:** Turn the computer on.

---

**Cause:** The HP All-in-One is not properly connected to the computer.

**Solution:** If the HP All-in-One is directly connected to a computer with a USB cable, check the physical connection from the HP All-in-One to the computer. Verify that the USB cable is securely plugged into the USB port on the back of the HP All-in-One. Make sure the other end of the USB cable is plugged into a USB port on your computer. After the cable is connected properly, turn the HP All-in-One off and then on again.

If the HP All-in-One is network-connected, check physical network connections and make sure the network is operational. Once you verify network connectivity, retry the task.

For more information, see:

- [“Communication problems over a USB connection”](#) on page 169
  - [“Network troubleshooting”](#) on page 183
- 

### Memory card or storage device is not available

**Cause:** If this message appears on your display, it means that another user is accessing the memory card or storage device over the network. Other users who try to use the same memory device might see a read/write error message. The memory device might not appear, as expected, in a list of shared network drives. In addition, if the HP All-in-One is connected to your computer by a USB cable, the computer might be accessing the memory card or storage device, making it inaccessible to the HP All-in-One.

**Solution:** Wait until the other user has finished using the memory card or storage device.

---

### Photos in a connected digital camera with PictBridge do not print

**Cause:** The digital camera is not in PictBridge mode.

**Solution:** If the camera supports PictBridge, make sure the camera is set to PictBridge mode. See the user guide that came with the camera for instructions on how to do this.

---

**Cause:** The images are not in a supported format.

**Solution:** Make sure the digital camera is saving photos in a file format that the PictBridge transfer feature supports (exif/JPEG, JPEG, and DPOF).

---

**Cause:** You did not select any photos on the camera for printing.

**Solution:** Before you connect the digital camera to the front USB port on the HP All-in-One, select some photos on the camera for printing.

---

 **NOTE:** Some digital cameras do not allow you to select photos until after you have established a PictBridge connection. If this is the case, connect your digital camera to the front USB port, turn on the camera and change it to PictBridge mode, and then use the camera to select the photos you want to print.

---

### The file name appears as meaningless text

**Cause:** The HP All-in-One does not support Unicode. This is a limitation of the Common Internet File System (CIFS) server.

The CIFS server is included in all network-connected HP All-in-One devices. It provides network drive letter access to the memory card or storage device in the

HP All-in-One. This lets you read/write files on the network from the memory card or storage device in the HP All-in-One. The CIFS server appears on your computer as a network drive. In addition to reading/writing files from your memory card or storage device, you can also create folders and store other information.

**Solution:** If a file name was created with Unicode by another application, it will display as arbitrary characters.

---

### Other users on the network can access my memory card or storage device

**Cause:** The Common Internet File System (CIFS) server in the HP All-in-One does not support authentication. This is a limitation of the CIFS server.

The CIFS server is included in all network-connected HP All-in-One devices. It provides network drive letter access to the memory card or storage device in the HP All-in-One. This lets you read/write files on the network from the memory card or storage device in the HP All-in-One. The CIFS server appears on your computer as a network drive. In addition to reading/writing files from your memory card or storage device, you can also create folders and store other information.

**Solution:** Every user on the network can access the memory card or storage device.

---

### Error message: Cannot find the file or item. Make sure the path and file name are correct.

**Cause:** The Common Internet File System (CIFS) server in the HP All-in-One is not operational.

The CIFS server is included in all network-connected HP All-in-One devices. It provides network drive letter access to the memory card or storage device in the HP All-in-One. This lets you read/write files on the network from the memory card or storage device in the HP All-in-One. The CIFS server appears on your computer as a network drive. In addition to reading/writing files from your memory card or storage device, you can also create folders and store other information.

**Solution:** Retry your task at a later time.

---

## Scan troubleshooting

Use this section to solve these scan problems:

- [Scan halts](#)
- [Scan fails](#)
- [Scan fails because of insufficient computer memory](#)
- [Scanned image is blank](#)
- [Scanned image is incorrectly cropped](#)
- [Scanned image has incorrect page layout](#)
- [Scanned image shows dotted lines instead of text](#)
- [Text format is incorrect](#)

- [Text is incorrect or missing](#)
- [The scan feature does not work](#)

### Scan halts

**Cause:** The computer system resources might be low.

**Solution:** Turn off the HP All-in-One and then turn it back on. Turn off the computer and then turn it back on.

If this does not work, try changing the scan to a lower resolution.

---

### Scan fails

**Cause:** The computer is not turned on.

**Solution:** Turn on your computer.

---

**Cause:** Your computer is not connected to the HP All-in-One by a USB cable or network cable.

**Solution:** Connect your computer to the HP All-in-One with a standard USB cable or across a network.

---

**Cause:** The HP All-in-One software might not have been installed.

**Solution:** Insert the HP All-in-One installation CD and install the software.

---

**Cause:** The software you installed with the HP All-in-One is not running.

**Solution:** Open the software you installed with the HP All-in-One and try scanning again.

---

### Scan fails because of insufficient computer memory

**Cause:** Too many programs are running on your computer.

**Solution:** Close all programs that are not in use. This includes programs that run in the background, such as screen savers and virus checkers. If you turn off your virus checker, remember to turn it back on after you finish your scan.

If this does not work, it might help to restart your computer. Some programs do not release memory when you close them. Restarting your computer will clear the memory.

If this problem occurs frequently, or if you encounter memory problems while using other programs, you might need to add more memory to your computer. See the user guide that came with your computer for more information.

---

### Scanned image is blank

**Cause:** The original is placed incorrectly on the glass.

**Solution:** Load your original print side down on the right front corner of the glass.

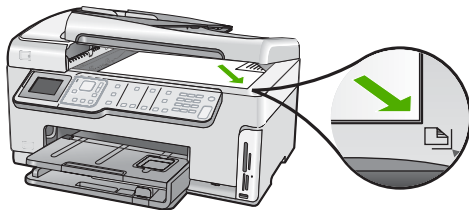

### Scanned image is incorrectly cropped

**Cause:** The software is set to automatically crop scanned pictures.

**Solution:** The **Autocrop** feature crops anything that is not part of the main image. Sometimes this might not be what you want. In that case, you can turn off autocropping and crop the scanned image manually, or not at all.

### Scanned image has incorrect page layout

**Cause:** Automatic cropping is changing the page layout.

**Solution:** Turn off automatic cropping to retain the page layout.

### Scanned image shows dotted lines instead of text

**Cause:** If you use the **Text** image type to scan text that you plan to edit, the scanner might not recognize color text. The **Text** image type scans at 300 x 300 dpi, in black and white.

If you are scanning an original that has graphics or artwork surrounding the text, the scanner might not recognize the text.

**Solution:** Make a black-and-white copy of the original and then scan the copy.

### Text format is incorrect

**Cause:** The scan document settings are incorrect.

**Solution:** Some applications cannot handle framed text formatting. Framed text is one of the scan document settings. It maintains complex layouts, such as multiple columns from a newsletter, by putting the text in different frames (boxes) in the destination application.

### Text is incorrect or missing

**Cause:** The brightness is not set correctly.

**Solution:** Adjust the brightness, and then rescan the original.

**Cause:** Debris might be stuck on the glass or on the back of the document lid. This can cause poor-quality scans.

**Solution:** Clean the glass and lid backing.

For more information, see:

- [“Clean the lid backing” on page 157](#)
- [“Clean the glass” on page 155](#)

---

**Cause:** The scan document settings are not set to the correct optical character recognition (OCR) language. The **OCR language** tells the software how to interpret the characters it sees in the original image. If the **OCR language** does not match the language in the original, the scanned text might be incomprehensible.

**Solution:** Select the correct OCR language.

---

 **NOTE:** If you are using HP Photosmart Essential, the Optical Character Recognition (OCR) software might not be installed on your computer. To install the OCR software, you must re-insert the software disk and select **OCR** under the **Custom** installation options.

---

### The scan feature does not work

**Cause:** The computer is turned off.

**Solution:** Turn the computer on.

---

**Cause:** The HP All-in-One is not properly connected to the computer through a USB cable.

**Solution:** Check the cables that connect the HP All-in-One to your computer.

---

**Cause:** The software that came with the HP All-in-One is not installed or is not running.

**Solution:** Restart your computer. If that does not help, install or reinstall the software that came with the HP All-in-One.

---

## Copy troubleshooting

Use this section to solve these copy problems:

- [Copies are too light or too dark](#)
- [Nothing happens when I try to copy](#)
- [Parts of the original do not appear or are cut off](#)
- [Fit to Page is not working as expected](#)
- [A borderless copy has white space around the edges](#)
- [The image is cropped when I make a borderless copy](#)
- [The printout is blank](#)



### Copies are too light or too dark

**Cause:** The **Lighter/Darker** setting for the HP All-in-One is set too light or too dark.

**Solution:** Adjust the lightness and darkness of the copies.

For more information, see:

[“Adjust the lightness and darkness of your copy” on page 125](#)

---

**Cause:** The original you are copying is overexposed.

**Solution:** Try using **Enhancements** to improve an overexposed image.

For more information, see:

[“Improve the quality of a copy” on page 129](#)

---

### Nothing happens when I try to copy

**Cause:** The HP All-in-One is turned off.

**Solution:** Look at the display on the HP All-in-One. If the display is blank and the **On** button is not lit, the HP All-in-One is turned off. Make sure the power cord is firmly connected to the HP All-in-One and plugged into a power outlet. Press the **On** button to turn on the HP All-in-One.

---

**Cause:** The original is placed incorrectly on the glass.

**Solution:** Load the original on the glass.

For more information, see:

[“Load an original on the glass” on page 72.](#)

---

**Cause:** The HP All-in-One might be busy copying or printing.

**Solution:** Check the display to see if the HP All-in-One is busy.

---

**Cause:** The HP All-in-One does not recognize the paper type.

**Solution:** Do not use the HP All-in-One to copy onto envelopes or other papers the HP All-in-One does not support.

---

**Cause:** The HP All-in-One has a paper jam.

**Solution:** Clear the paper jam and remove any torn paper that remains in the HP All-in-One.

For more information, see:

[“Clear paper jams” on page 171](#)

---

### Parts of the original do not appear or are cut off

**Cause:** The original is placed incorrectly on the glass.

**Solution:** Reload the original on the glass.

For more information, see:

[“Load originals” on page 71](#)

---

**Cause:** The original fills the entire sheet.

**Solution:** If the image or text on your original fills the entire sheet with no margins, use the **Fit to Page** feature to reduce your original and prevent unwanted cropping of the text or images at the edges of the sheet.

For more information, see:

[“Resize an original to fit onto letter or A4 paper” on page 127](#)

---

**Cause:** The original is larger than the paper in the input tray.

**Solution:** If your original is larger than the paper in the input tray, use the **Fit to Page** feature to reduce your original to fit on the paper in the input tray.

For more information, see:

[“Resize an original to fit onto letter or A4 paper” on page 127](#)

---

### **Fit to Page is not working as expected**

**Cause:** You are trying to increase the size of an original that is too small.

**Solution:** **Fit to Page** can only enlarge the original up to the maximum percentage allowed by your model. (The maximum percentage varies by model.) For example, 200% might be the maximum enlargement percentage allowed by your model. Enlarging a passport photo by 200% might not enlarge it enough for it to fit a full-size page.

If you want to make a large copy of a small original, scan the original into the computer, resize the image in the HP scanning software, and then print a copy of the enlarged image.

---

**Cause:** The original is placed incorrectly on the glass.

**Solution:** Reload the original on the glass.

For more information, see:

[“Load originals” on page 71](#)

---

**Cause:** Debris might be stuck on the glass or on the back of the document lid. The HP All-in-One interprets anything it detects on the glass as part of the image.

**Solution:** Turn off the HP All-in-One, and then use a soft cloth to wipe the glass and the back of the document lid.

For more information, see:

- [“Clean the glass” on page 155](#)
  - [“Clean the lid backing” on page 157](#)
-

### A borderless copy has white space around the edges

**Cause:** You are trying to make a borderless copy of an original that is too small.

**Solution:** When you make a borderless copy of a small original, the HP All-in-One enlarges the original up to a maximum percentage. This might leave white space around the edges. (The maximum percentage varies by model.)

Depending on the size of the borderless copy you are trying to make, the minimum size of the original varies. For example, you cannot enlarge a passport photo to create a letter-size borderless copy.

If you want to make a borderless copy of a very small original, scan the original into the computer, resize the image in the HP scanning software, and then print a borderless copy of the enlarged image.

---

**Cause:** You are trying to make a borderless copy without using photo paper.

**Solution:** Use photo paper to make borderless copies.

For more information, see:

[“Make a borderless copy of a photo” on page 126](#)

---

**Cause:** Debris might be stuck on the glass or on the back of the document lid. The HP All-in-One interprets anything it detects on the glass as part of the image.

**Solution:** Turn off the HP All-in-One, and then use a soft cloth to wipe the glass and the back of the document lid.

For more information, see:

- [“Clean the glass” on page 155](#)
- [“Clean the lid backing” on page 157](#)

---

### The image is cropped when I make a borderless copy

**Cause:** The HP All-in-One cropped some of the image around the margins of the copy to achieve a borderless print without changing the proportions of the original.

**Solution:** If you want to enlarge a photo to fit a full-size page without cropping the edges, use **Fit to Page**.

For more information, see:

- [“Resize an original to fit onto letter or A4 paper” on page 127](#)
- [“Resize an original using custom settings” on page 127](#)

---

**Cause:** The original is larger than the paper in the input tray.

**Solution:** If your original is larger than the paper in the input tray, use the **Fit to Page** feature to reduce your original to fit on the paper in the input tray.

For more information, see:

[“Resize an original to fit onto letter or A4 paper” on page 127](#)

---

### The printout is blank

**Cause:** The original is placed incorrectly on the glass.

**Solution:** Reload the original on the glass.

For more information, see:

[“Load originals” on page 71](#)

---

## Fax troubleshooting

Use this section to solve the following fax problems:

- [The HP All-in-One is having problems sending and receiving faxes](#)
- [The HP All-in-One cannot send faxes, but can receive faxes](#)
- [The HP All-in-One is having problems sending a manual fax](#)
- [Pages of a fax I sent are missing](#)
- [The quality of the fax I sent is poor](#)
- [Parts of a fax I sent are cut off](#)
- [The fax I sent was blank when it was received](#)
- [Fax transmission is slow](#)
- [The HP All-in-One cannot receive faxes, but can send faxes](#)
- [The HP All-in-One is having problems receiving a manual fax](#)
- [Fax tones are recorded on my answering machine](#)
- [The HP All-in-One is not answering incoming fax calls](#)
- [Pages of a fax I received are missing](#)
- [Faxes are received but do not print](#)
- [Parts of a fax I received are cut off](#)
- [The computer to which I am connecting has only one phone port](#)
- [I hear static on my telephone line since connecting the HP All-in-One](#)
- [The fax test failed](#)
- [I am having problems faxing over the Internet using IP phone](#)
- [The fax log report shows an error](#)

### The HP All-in-One is having problems sending and receiving faxes

**Cause:** The HP All-in-One is not set up properly for faxing.

**Solution:** Follow the instructions in your printed documentation to set up the HP All-in-One properly for faxing, based on the equipment and services you have on the same phone line as the HP All-in-One. Then, run a fax test to check the status of the HP All-in-One and to make sure you set it up properly.

The HP All-in-One prints a report with the results of the test. If the test fails, review the report for information on how to fix the problem.

For more information, see:

[“Test your fax setup” on page 63](#)

---

**Cause:** The HP All-in-One is turned off.

**Solution:** Look at the display on the HP All-in-One. If the display is blank and the **On** button is not lit, the HP All-in-One is turned off. Make sure the power cord is firmly connected to the HP All-in-One and plugged into a power outlet. Press the **On** button to turn on the HP All-in-One.

**Cause:** The wrong phone cord is used to connect the HP All-in-One or the phone cord is plugged into the wrong port.

**Solution:**

**NOTE:** This possible solution applies only in the countries/regions that receive a 2-wire phone cord in the box with the HP All-in-One, including: Argentina, Australia, Brazil, Canada, Chile, China, Colombia, Greece, India, Indonesia, Ireland, Japan, Korea, Latin America, Malaysia, Mexico, Philippines, Poland, Portugal, Russia, Saudi Arabia, Singapore, Spain, Taiwan, Thailand, USA, Venezuela, and Vietnam.

Make sure you used the phone cord supplied in the box with the HP All-in-One to connect to the telephone wall jack. One end of this special 2-wire phone cord should be connected to the port labeled 1-LINE on the back of the HP All-in-One and the other end to your telephone wall jack, as shown below.

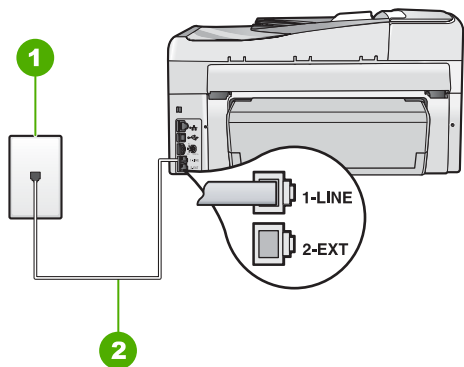

- 1 Telephone wall jack
- 2 Use the phone cord supplied in the box with the HP All-in-One

This special 2-wire phone cord is different from the more common 4-wire phone cords you might already have in your office. Check the end of the cord and compare it to the two types of cords shown below.

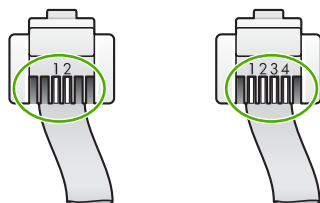

If you used a 4-wire phone cord, disconnect it, find the supplied 2-wire phone cord, and then connect the 2-wire phone cord to the port labeled 1-LINE on the back of the HP All-in-One.

If the HP All-in-One came with a 2-wire phone cord adaptor, you can use it with a 4-wire phone cord, in case the supplied 2-wire phone cord is too short. Attach the 2-wire phone cord adaptor to the port labeled 1-LINE on the back of the HP All-in-One. Attach your 4-wire phone cord to the open port on the adaptor and to the telephone wall jack. For more information on using the 2-wire phone cord adaptor, see the documentation that came with it.

For more information on setting up the HP All-in-One, see the printed documentation that came with the HP All-in-One.

---

**Cause:** Other office equipment (such as an answering machine or a telephone) is not set up properly with the HP All-in-One.

**Solution:**

---

 **NOTE:** This possible solution applies only in the countries/regions that receive a 2-wire phone cord in the box with the HP All-in-One, including: Argentina, Australia, Brazil, Canada, Chile, China, Colombia, Greece, India, Indonesia, Ireland, Japan, Korea, Latin America, Malaysia, Mexico, Philippines, Poland, Portugal, Russia, Saudi Arabia, Singapore, Spain, Taiwan, Thailand, USA, Venezuela, and Vietnam.

---

Make sure you have correctly connected the HP All-in-One to the telephone wall jack, and correctly connected any additional equipment and services that share the phone line with the HP All-in-One.

Use the port labeled 1-LINE on the back of the HP All-in-One to connect to the telephone wall jack. Use the 2-EXT port to connect to any other equipment, such as an answering machine or a telephone, as shown below.

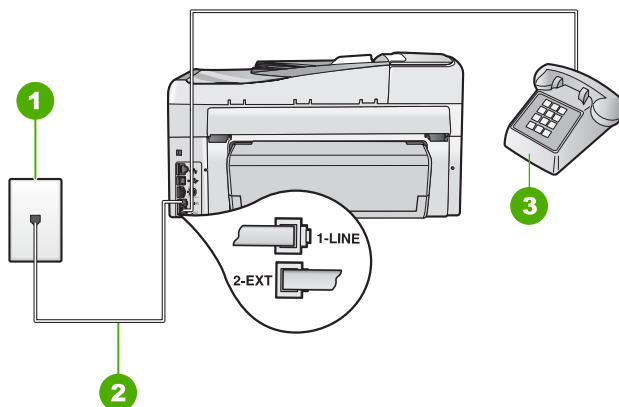

1	Telephone wall jack
2	Use the phone cord supplied in the box with the HP All-in-One
3	Telephone (optional)

For more information on setting up the HP All-in-One, see the printed documentation that came with the HP All-in-One.

**Cause:** You are using a phone line splitter.

**Solution:** A phone line splitter can cause faxing problems. (A splitter is a two-cord connector that plugs into a telephone wall jack.) Try removing the splitter and connecting the HP All-in-One directly to the telephone wall jack.

**Cause:** The telephone wall jack is not working properly.

**Solution:** Try connecting a working telephone and phone cord to the telephone wall jack you are using for the HP All-in-One and check for a dial tone. If you do not hear a dial tone, call your local telephone company for service.

**Cause:** The phone line connection is noisy. Phone lines with poor sound quality (noise) can cause faxing problems.

**Solution:** If the failure was due to noise on the phone line, contact the sender to have them resend the fax. The quality might be better when you try again. You can check the sound quality of the phone line by plugging a phone into the telephone wall jack and listening for static or other noise. If the problem persists, turn **Error Correction Mode (ECM)** off and contact your telephone company.

If you are still having problems faxing, set the **Fax Speed** to a slower rate such as **Medium (14400)** or **Slow (9600)**.

For more information, see:

- [“Send a fax in Error Correction Mode” on page 139](#)
- [“Set the fax speed” on page 30](#)

---

**Cause:** Other equipment that uses the same phone line as the HP All-in-One might be in use.

**Solution:** Make sure extension phones (phones on the same phone line, but not connected to the HP All-in-One) or other equipment are not in use or off the hook. For example, you cannot use the HP All-in-One for faxing if an extension phone is off the hook, or if you are using a computer dial-up modem to send e-mail or access the Internet.

---

**Cause:** The HP All-in-One shares the same phone line with a DSL service and a DSL filter is not connected.

**Solution:** If you use a DSL service, make sure that you have a DSL filter connected or you will not be able to fax successfully. The DSL service sends out a digital signal on the phone line that can interfere with the HP All-in-One, preventing the HP All-in-One from sending and receiving faxes. The DSL filter removes the digital signal and allows the HP All-in-One to communicate properly with the phone line. To check if you already have a filter installed, listen to your phone line or dial tone. If you hear noise or static on the line, you probably do not have a DSL filter installed, or it is installed incorrectly. Obtain a DSL filter from your DSL provider. If you already have a DSL filter, make sure it is connected correctly.

---

**Cause:** Another process has caused an error in the HP All-in-One.

**Solution:** Check the display or your computer for an error message providing information about the problem and how to solve it. If there is an error, the HP All-in-One will not send or receive a fax until the error condition is resolved.

You can also check the status of the HP All-in-One by clicking **Status** in the HP Solution Center.

For more information, see:

[“Errors” on page 258](#)

---

**Cause:** You are using either a PBX or an ISDN converter/terminal adapter.



**Solution:**

- Make sure the HP All-in-One is connected to the port that is designated for fax and phone use. Also, make sure that the terminal adapter is set to the correct switch type for your country/region, if possible.



**NOTE:** Some ISDN systems allow you to configure the ports for specific phone equipment. For example, you might have assigned one port for telephone and Group 3 fax and another port for multiple purposes. If you have problems when connected to the fax/phone port of your ISDN converter, try using the port designated for multiple purposes; it might be labeled "multi-combi" or something similar.

---

For more information on how to set up the HP All-in-One with a PBX phone system or ISDN line, see the printed documentation that came with the HP All-in-One.

- Try setting the **Fax Speed** to **Medium (14400)** or **Slow (9600)**.

For more information, see:

["Set the fax speed" on page 30](#)

---

**Cause:** The **Fax Speed** setting is set too fast.

**Solution:** You might need to send and receive faxes at a slower rate. Try setting the **Fax Speed** to **Medium (14400)** or **Slow (9600)** if you use one of the following:

- An Internet phone service
- A PBX system
- Fax over Internet Protocol (FoIP)
- An ISDN service

For more information, see:

["Set the fax speed" on page 30](#)

---

**Cause:** The HP All-in-One might be connected to a telephone wall jack that is set up for digital phones.

**Solution:** Make sure you connect the HP All-in-One to an analog phone line or you will not be able to send or receive faxes. To check if your phone line is digital, connect a regular analog phone to the line and listen for a dial tone. If you do not hear a normal sounding dial tone, it might be a phone line set up for digital phones. Connect the HP All-in-One to an analog phone line and try sending or receiving a fax.

---

**Cause:** The HP All-in-One shares the same phone line with a DSL service and the DSL modem might not be properly grounded.

**Solution:** If the DSL modem is not properly grounded, it can create noise on the phone line. Phone lines with poor sound quality (noise) can cause faxing problems.

You can check the sound quality of the phone line by plugging a phone into the telephone wall jack and listening for static or other noise.

**If you hear noise, do the following**

1. Turn off your DSL modem and completely remove power for at least 15 minutes.
2. Turn the DSL modem back on.
3. Listen to the dial tone again. If the dial tone sounds clear (no noise or static), try sending or receiving a fax.

---

 **NOTE:** You might notice static on the phone line again in the future. If the HP All-in-One stops sending and receiving faxes, repeat this process.

---

If the phone line is still noisy, contact your phone company. For information on turning your DSL modem off, contact your DSL provider for support.

---

**Cause:** You are faxing over the Internet using an IP phone, and there was a problem with the transmission.

**Solution:** Try resending your fax at a later time. Also, make sure your Internet service provider supports faxing over the Internet.

If the problem persists, contact your Internet service provider.

---

**The HP All-in-One cannot send faxes, but can receive faxes**

**Cause:** The HP All-in-One is not set up properly for faxing.

**Solution:** Follow the instructions in your printed documentation to set up the HP All-in-One properly for faxing, based on the equipment and services you have on the same phone line as the HP All-in-One. Then, run a fax test to check the status of the HP All-in-One and to make sure you set it up properly.

The HP All-in-One prints a report with the results of the test. If the test fails, review the report for information on how to fix the problem.

For more information, see:

[“Test your fax setup” on page 63](#)

---

**Cause:** The HP All-in-One might be dialing too fast or too soon.

**Solution:** You might need to insert some pauses in the number sequence. For example, if you need to access an outside line before dialing the phone number, insert a pause following the access number. If your number is 95555555, and 9 accesses an outside line, you might insert pauses as follows: 9-555-5555. To enter a pause in the fax number you are typing, press the **Space** button repeatedly until a dash (-) appears on the display.

If you are using a speed dial entry to send the fax, update the speed dial entry to include pauses in the number sequence.

You can also send the fax using monitor dialing. This enables you to listen to the phone line as you dial. You can set the pace of your dialing and respond to prompts as you dial.

For more information, see:

- [“Update individual speed dial entries” on page 66](#)
- [“Send a fax using monitor dialing” on page 134](#)

---

**Cause:** The number you entered when sending the fax is not in the proper format.

**Solution:** Check to see that the fax number you entered is correct and in the proper format. For example, you might need to dial a "9" prefix, depending on your phone system.

If your phone line has a PBX system, make sure you are dialing the number for an outside line before dialing the fax number.

---

**Cause:** The receiving fax machine is having problems.

**Solution:** To check this, try calling the fax number from a telephone and listen for fax tones. If you cannot hear fax tones, the receiving fax might not be turned on or connected, or a voice mail service could be interfering with the recipient's phone line. You can also ask the recipient to check the receiving fax machine for any problems.

---

### The HP All-in-One is having problems sending a manual fax

**Cause:** The recipient's fax machine might not support receiving faxes manually.

**Solution:** Check with the recipient to see if their fax machine can receive faxes manually.

---

**Cause:** You did not press **Start Fax Black** or **Start Fax Color** within three seconds of hearing fax tones.

**Solution:** If you are sending a fax manually, make sure that you press **Start Fax Black** or **Start Fax Color** within three seconds of hearing the recipient's fax tones, otherwise the transmission might fail.

For more information, see:

[“Send a fax manually from a phone” on page 133](#)

---

**Cause:** The telephone used to initiate the fax call was not connected directly to the HP All-in-One or was not connected properly.

## Solution:

 **NOTE:** This possible solution applies only in the countries/regions that receive a 2-wire phone cord in the box with the HP All-in-One, including: Argentina, Australia, Brazil, Canada, Chile, China, Colombia, Greece, India, Indonesia, Ireland, Japan, Korea, Latin America, Malaysia, Mexico, Philippines, Poland, Portugal, Russia, Saudi Arabia, Singapore, Spain, Taiwan, Thailand, USA, Venezuela, and Vietnam.

To send a fax manually, the telephone must be connected directly to the port labeled 2-EXT on the HP All-in-One, as shown below.

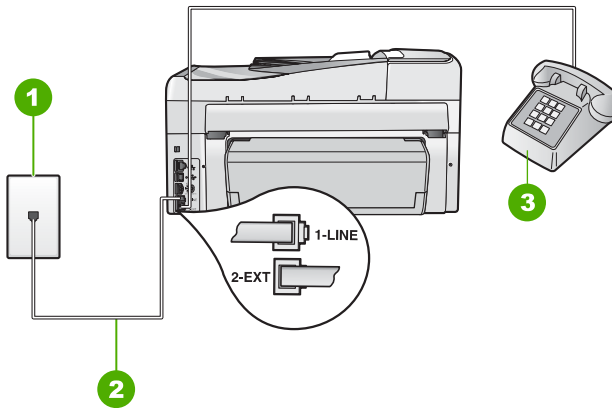

1	Telephone wall jack
2	Use the phone cord supplied in the box with the HP All-in-One
3	Telephone

For more information on setting up the HP All-in-One with your telephone, see the printed documentation that came with the HP All-in-One.

**Cause:** The **Fax Speed** setting might be set too fast.

**Solution:** Try setting the **Fax Speed** to **Medium (14400)** or **Slow (9600)**, and then resend the fax.

For more information, see:

[“Set the fax speed” on page 30](#)

**Cause:** The HP All-in-One is not detecting an original loaded in the document feeder tray.

**Solution:** If you did not load an original in the document feeder tray, or if the original is not pushed in far enough, you will be unable to send a fax manually. Load an original in the document feeder tray, or push the original farther into the tray. Once the HP All-in-One detects the original, a confirmation message appears on the display.

### Pages of a fax I sent are missing

**Cause:** Two or more pages were fed through the document feeder tray at the same time.

**Solution:** Print a **Last Transaction** report to verify the number of pages that were sent. If two or more pages stuck together and were fed into the document feeder tray at the same time, the number of pages in the report would not match the actual number of pages. If the number of pages listed in the report does not match the actual number of pages, you might need to clean the separator pad in the automatic document feeder.

For more information, see:

- [“Print other reports” on page 152](#)
- [“Clean the automatic document feeder” on page 173](#)

**Cause:** The receiving fax machine is having problems.

**Solution:** To check this, try calling the fax number from a telephone and listen for fax tones. If you cannot hear fax tones, the receiving fax might not be turned on or connected, or a voice mail service could be interfering with the recipient's phone line. The memory of the receiving fax machine might be full or the fax machine might have run out of paper. You can ask the recipient to check the receiving fax machine for any problems.

**Cause:** The phone line connection is noisy. Phone lines with poor sound quality (noise) can cause faxing problems.

**Solution:** If the failure was due to noise on the phone line, resend the fax. The quality might be better when you try again. You can check the sound quality of the phone line by plugging a phone into the telephone wall jack and listening for static or other noise. If the problem persists, turn **Error Correction Mode** (ECM) off and contact your telephone company.

For more information, see:

[“Send a fax in Error Correction Mode” on page 139](#)

### The quality of the fax I sent is poor

**Cause:** The phone line connection is noisy. Phone lines with poor sound quality (noise) can cause faxing problems.

**Solution:** If the failure was due to noise on the phone line, resend the fax. The quality might be better when you try again. You can check the sound quality of the phone line by plugging a phone into the telephone wall jack and listening for static or other noise. If the problem persists, turn **Error Correction Mode** (ECM) off and contact your telephone company.

If the problem persists, check to see if **Error Correction Mode** (ECM) is **On**. If it is not, change the ECM setting to **On**. Faxes might take longer to send, but the print quality of the received fax should improve.

If the print quality is still poor, turn off ECM, and then contact your telephone provider.

For more information, see:

[“Send a fax in Error Correction Mode” on page 139](#)

---

**Cause:** The fax resolution setting is set to a low resolution, such as **Standard**.

**Solution:** For the highest-quality fax, change the fax resolution to **Fine**, **Very Fine** (if available), or **Photo**.

For more information, see:

[“Change the fax resolution” on page 137](#)

---

**Cause:** The glass of the HP All-in-One might be dirty.

**Solution:** If you are sending a fax from the glass, make a copy to check the quality of the printout. If the quality of the printout is poor, clean the glass.

For more information, see:

- [“Make a copy” on page 121](#)
  - [“Clean the glass” on page 155](#)
- 

**Cause:** The receiving fax machine is having problems.

**Solution:** To check this, try calling the fax number from a telephone and listen for fax tones. If you cannot hear fax tones, the receiving fax might not be turned on or connected, or a voice mail service could be interfering with the recipient's phone line. You can also ask the recipient to check the receiving fax machine for any problems.

---

**Cause:** The **Lighter/Darker** setting might be set too light. If you are sending a faded, washed out, or handwritten fax, or a document with a watermark (such as a red seal or stamp), you can change the **Lighter/Darker** setting to send the fax darker than the original.

**Solution:** Make a copy to check the quality of the printout. If the printout is too light, you can darken it by adjusting the **Lighter/Darker** setting when sending the fax.

For more information, see:

[“Change the Lighter/Darker setting” on page 138](#)

---

### Parts of a fax I sent are cut off

**Cause:** The fax is larger than letter or A4 paper.

**Solution:** Some fax machines cannot accept faxes larger than letter or A4 paper. Make sure the receiving fax machine can accept the paper size you are using. If not, ask the recipient if the receiving fax machine has a fit to page setting they can use to reduce the incoming fax to fit standard paper size such as letter or A4.

---

### The fax I sent was blank when it was received

**Cause:** The original was not loaded or was loaded incorrectly.

**Solution:** Load your originals print side up into the document feeder tray. If you are sending a single-page fax, such as a photograph, you can also load your original print side down on the glass.

For more information, see:

[“Load originals” on page 71](#)

---

### Fax transmission is slow

**Cause:** You are sending a fax in color.

**Solution:** Sending a fax in color can take longer than sending a black-and-white fax. Try sending the fax in black and white.

---

**Cause:** The document contains a lot of graphics or has very fine detail.

**Solution:** For faster transmission, use **Standard** resolution. This setting provides the fastest possible transmission with the lowest quality of fax. The default resolution is **Fine**, which can take longer to send.

For more information, see:

[“Change the fax resolution” on page 137](#)

---

**Cause:** The phone line connection is noisy. Phone lines with poor sound quality (noise) can cause faxing problems.

**Solution:** If the failure was due to noise on the phone line, contact the sender to have them resend the fax. The quality might be better when you try again. You can check the sound quality of the phone line by plugging a phone into the telephone wall jack and listening for static or other noise. If the problem persists, turn **Error Correction Mode** (ECM) off and contact your telephone company.

For more information, see:

[“Send a fax in Error Correction Mode” on page 139](#)

---

**Cause:** The fax resolution setting is set to a high resolution, such as **Fine** (the default) or **Photo**.

**Solution:** For faster transmission, use **Standard** resolution. This setting provides the fastest possible transmission with the lowest quality of fax.

For more information, see:

[“Change the fax resolution” on page 137](#)

---

**Cause:** The receiving fax machine is having problems.

**Solution:** To check this, try calling the fax number from a telephone and listen for fax tones. If you cannot hear fax tones, the receiving fax might not be turned on or

connected, or a voice mail service could be interfering with the recipient's phone line. You can also ask the recipient to check the receiving fax machine for any problems.

---

**Cause:** The **Fax Speed** option is set to a slow transmission speed.

**Solution:** Make sure the **Fax Speed** option is set to **Fast (33600)** or **Medium (14400)**.

For more information, see:

[“Set the fax speed” on page 30](#)

---

### The HP All-in-One cannot receive faxes, but can send faxes

**Cause:** The HP All-in-One is not set up properly for faxing.

**Solution:** Follow the instructions in your printed documentation to set up the HP All-in-One properly for faxing, based on the equipment and services you have on the same phone line as the HP All-in-One. Then, run a fax test to check the status of the HP All-in-One and to make sure you set it up properly.

The HP All-in-One prints a report with the results of the test. If the test fails, review the report for information on how to fix the problem.

For more information, see:

[“Test your fax setup” on page 63](#)

---

**Cause:** **Auto Answer** is turned off, which means that the HP All-in-One will not answer incoming calls. You must be available to respond in person to incoming fax calls, or the HP All-in-One will not answer the incoming fax call.

**Solution:** Depending on your office setup, you might be able to set the HP All-in-One to answer incoming calls automatically. To find out what the recommended answer mode is for your office setup, see the printed documentation that came with the HP All-in-One.

If you must have **Auto Answer** off, you will need to press **Start Fax Black** or **Start Fax Color** to receive a fax.

 **TIP:** If you are not close enough to the HP All-in-One to reach the control panel, wait several seconds, and then press **1 2 3** on your phone. If the HP All-in-One does not begin receiving the fax, wait several more seconds and press **1 2 3** again. After the HP All-in-One begins to receive the fax, you can hang up the phone.

---

**Cause:** You subscribe to a voice mail service at the same phone number you use for fax calls.

**Solution:** Set the HP All-in-One to answer faxes manually. You cannot receive faxes automatically if you have a voice mail service at the same phone number you use for fax calls. You must receive faxes manually; this means you must be available to respond in person to incoming fax calls.



For more information on how to set up the HP All-in-One when you have a voice mail service, see the printed documentation that came with the HP All-in-One.

---

**Cause:** You have a computer dial-up modem on the same phone line as the HP All-in-One.

**Solution:** If you have a computer dial-up modem on the same phone line as the HP All-in-One, check to make sure that the software that came with your modem is not set to receive faxes automatically. Modems that are set up to receive faxes automatically take over the phone line to receive all incoming faxes, which prevents the HP All-in-One from receiving fax calls.

---

**Cause:** If you have an answering machine on the same phone line with the HP All-in-One, you might have one of the following problems:

- Your outgoing message might be too long or too loud to allow the HP All-in-One to detect fax tones, and the sending fax machine might disconnect.
- Your answering machine might not have enough quiet time after your outgoing message to allow the HP All-in-One to detect fax tones. This problem is most common with digital answering machines.

**Solution:** If you have an answering machine on the same phone line with the HP All-in-One, do the following:

- Disconnect the answering machine and then try receiving a fax. If faxing is successful without the answering machine, the answering machine might be causing the problem.
  - Reconnect the answering machine and record your outgoing message again. Record a message that is approximately 10 seconds in duration. Speak slowly and at a low volume when recording your message. Leave at least 5 seconds of silence at the end of the voice message. There should be no background noise when recording this silent time. Try to receive a fax again.
- 

**Cause:** The answering machine is not set up properly with the HP All-in-One.

**Solution:**

 **NOTE:** This possible solution applies only in the countries/regions that receive a 2-wire phone cord in the box with the HP All-in-One, including: Argentina, Australia, Brazil, Canada, Chile, China, Colombia, Greece, India, Indonesia, Ireland, Japan, Korea, Latin America, Malaysia, Mexico, Philippines, Poland, Portugal, Russia, Saudi Arabia, Singapore, Spain, Taiwan, Thailand, USA, Venezuela, and Vietnam.

---

When you have an answering machine on the same phone line you use for fax calls, you must connect the answering machine directly to the HP All-in-One using the port

labeled 2-EXT, as shown below. You also need to set the correct number of rings to answer for both the answering machine and HP All-in-One.

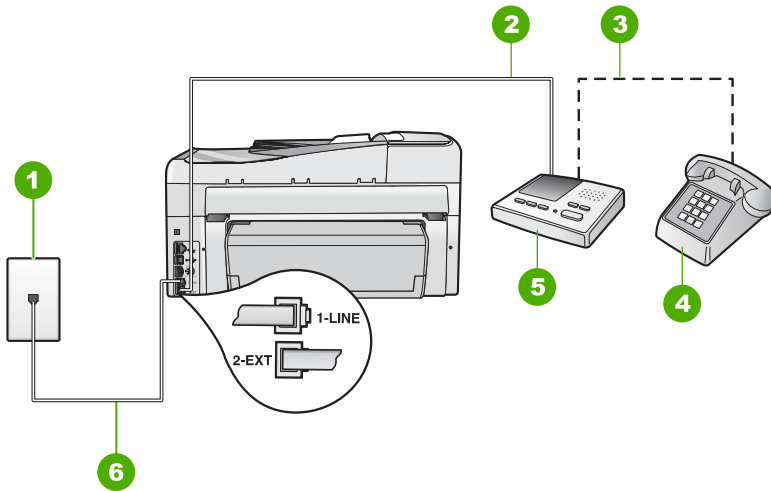

1	Telephone wall jack
2	Connect to the IN port on the answering machine
3	Connect to the OUT port on the answering machine
4	Telephone (optional)
5	Answering machine
6	Use the phone cord supplied in the box with the HP All-in-One

Make sure the HP All-in-One is set to receive faxes automatically and that the **Rings to Answer** setting is correct. The number of rings to answer for the HP All-in-One should be greater than the number of rings to answer for the answering machine. Set your answering machine to a low number of rings and the HP All-in-One to answer in the maximum number of rings supported by your device. (The maximum number of rings varies by country/region.) In this setup, the answering machine will answer the call and the HP All-in-One will monitor the line. If the HP All-in-One detects fax tones, the HP All-in-One will receive the fax. If the call is a voice call, the answering machine will record the incoming message.

For more information on setting up the HP All-in-One, see the printed documentation that came with the HP All-in-One.

For more information, see:

- [“Set the number of rings before answering” on page 62](#)
- [“Set the answer mode” on page 62](#)

**Cause:** You have a special ring pattern for your fax phone number (using a distinctive ring service through your telephone company), and the **Distinctive Ring** setting on the HP All-in-One does not match.

**Solution:** If you have a special ring pattern for your fax phone number (using a distinctive ring service through your telephone company), make sure that the

**Distinctive Ring** setting on the HP All-in-One is set to match. For example, if the phone company has assigned your number a double ring pattern, make sure **Double Rings** is selected as the **Distinctive Ring** setting.

---

 **NOTE:** The HP All-in-One cannot recognize some ring patterns, such as those with alternating short and long ringing patterns. If you are having problems with a ring pattern of this type, ask your phone company to assign a non-alternating ring pattern.

---

If you are not using a distinctive ring service, make sure that the **Distinctive Ring** setting on the HP All-in-One is set to **All Rings**.

For more information, see:

[“Change the answer ring pattern for distinctive ringing” on page 63](#)

---

**Cause:** The **Distinctive Ring** setting is not set to **All Rings** (and you are not using a distinctive ring service).

**Solution:** If you are not using a distinctive ring service, make sure that the **Distinctive Ring** setting on the HP All-in-One is set to **All Rings**.

---

**Cause:** The fax signal level might not be strong enough, which can cause fax reception problems.

**Solution:** If the HP All-in-One shares the same phone line with other types of phone equipment, such as an answering machine, a computer dial-up modem, or a multi-port switch box, the fax signal level might be reduced. The signal level can also be reduced if you use a splitter or connect extra cables to extend the length of your phone. A reduced fax signal can cause problems during fax reception.

- If you are using a splitter or extension cables, try removing them and connecting the HP All-in-One directly to the telephone wall jack.
  - To find out if other equipment is causing a problem, disconnect everything except the HP All-in-One from the phone line, and then try to receive a fax. If you can receive faxes successfully without the other equipment, one or more pieces of the other equipment is causing problems; try adding them back one at a time and receiving a fax each time, until you identify which equipment is causing the problem.
- 

**Cause:** The memory of the HP All-in-One is full.

**Solution:** If **Backup Fax Reception** is enabled and there is an error condition on the HP All-in-One, the memory might become full of faxes that have not yet been printed and the HP All-in-One will stop answering calls. If an error condition exists that is preventing the HP All-in-One from printing faxes, review the display for information on the error condition. Also, check for the following problems:

- The HP All-in-One is not set up properly for faxing. See the printed documentation for more information.
- There is no paper loaded in the input tray.
- There is a paper jam.

- The ink cartridge door is open. Close the ink cartridge door, as shown below:

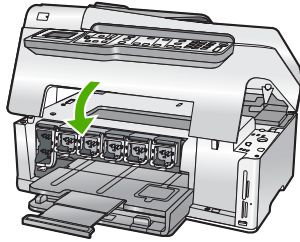

- The print head assembly is stalled. Turn the HP All-in-One off, remove any objects that are blocking the print head assembly (including any packing materials), and then turn the HP All-in-One on again.

Resolve any problems found. The HP All-in-One automatically begins printing all the unprinted faxes from memory. To clear the memory, you can also delete the faxes stored in memory by turning off the HP All-in-One.

---

**Cause:** An error condition is preventing the HP All-in-One from receiving faxes and **Backup Fax Reception** is set to **Off**.

**Solution:** Check for the following problems:

- The HP All-in-One is turned off. Press the **On** button to turn on the device.
- The HP All-in-One is not set up properly for faxing. See the printed documentation for more information.
- There is no paper loaded in the input tray.
- There is a paper jam.
- The ink cartridge door is open. Close the ink cartridge door.
- The print head assembly is stalled. Turn the HP All-in-One off, remove any objects that are blocking the print head assembly (including any packing materials), and then turn the HP All-in-One on again.

---

 **NOTE:** If **Backup Fax Reception** is enabled and you turn off the HP All-in-One, all faxes stored in memory are deleted, including any unprinted faxes that you might have received while the HP All-in-One was in an error condition. You will need to contact the senders to ask them to resend any unprinted faxes. For a list of the faxes you have received, print the **Fax Log**. The **Fax Log** is not deleted when the HP All-in-One is turned off.

---

After you resolve any problems found, the HP All-in-One can begin answering incoming fax calls.

### The HP All-in-One is having problems receiving a manual fax

**Cause:** There are documents loaded in the document feeder tray.

**Solution:** The HP All-in-One will not receive a fax manually if documents are loaded in the document feeder tray. Instead, the HP All-in-One attempts to send the

documents loaded in the document feeder tray. Remove any originals before manually receiving faxes.

You can also contact the sender to verify that there are documents loaded in the sending fax machine.

---

**Cause:** The **Fax Speed** setting might be set too fast.

**Solution:** Set the **Fax Speed** to **Medium (14400)** or **Slow (9600)**, and then contact the sender to have them resend the fax.

For more information, see:

[“Set the fax speed” on page 30](#)

---

**Cause:** There is an error message or other prompt on the display.

**Solution:** Check the display for an error message or prompt providing information about the problem and how to solve it. If there is an error message or prompt on the display, the HP All-in-One will not receive the fax manually until the error condition is resolved and the message is cleared.

If the HP All-in-One has an alignment message, you might be able to press **OK** to clear the message and resume faxing.

For more information, see:

- [“Align the printer” on page 161](#)
- [“Errors” on page 258](#)

---

### Fax tones are recorded on my answering machine

**Cause:** The answering machine is not set up properly with the HP All-in-One or the **Rings to Answer** setting is not correct.

**Solution:**

---

 **NOTE:** This possible solution applies only in the countries/regions that receive a 2-wire phone cord in the box with the HP All-in-One, including: Argentina, Australia, Brazil, Canada, Chile, China, Colombia, Greece, India, Indonesia, Ireland, Japan, Korea, Latin America, Malaysia, Mexico, Philippines, Poland, Portugal, Russia, Saudi Arabia, Singapore, Spain, Taiwan, Thailand, USA, Venezuela, and Vietnam.

---

When you have an answering machine on the same phone line you use for fax calls, you must connect the answering machine directly to the HP All-in-One using the port labeled 2-EXT, as shown below.

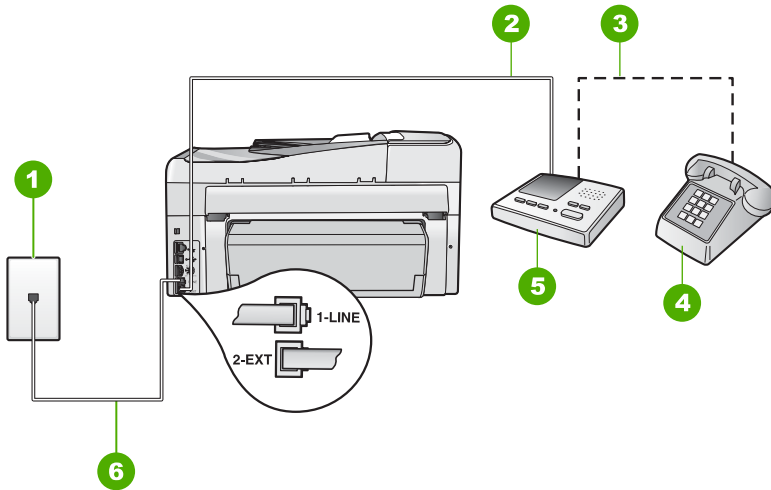

1	Telephone wall jack
2	Connect to the IN port on the answering machine
3	Connect to the OUT port on the answering machine
4	Telephone (optional)
5	Answering machine
6	Use the phone cord supplied in the box with the HP All-in-One

Make sure the HP All-in-One is set to receive faxes automatically and that the **Rings to Answer** setting is correct. The number of rings to answer for the HP All-in-One should be greater than the number of rings to answer for the answering machine. If the answering machine and the HP All-in-One are set to the same number of rings to answer, both devices will answer the call and fax tones will be recorded on the answering machine.

Set your answering machine to a low number of rings and the HP All-in-One to answer in the maximum number of rings supported. (The maximum number of rings varies by country/region.) In this setup, the answering machine will answer the call and the HP All-in-One will monitor the line. If the HP All-in-One detects fax tones, the HP All-in-One will receive the fax. If the call is a voice call, the answering machine will record the incoming message.

For more information on setting up the HP All-in-One when you have an answering machine, see the printed documentation that came with the HP All-in-One.

For more information, see:

- [“Set the answer mode” on page 62](#)
- [“Set the number of rings before answering” on page 62](#)

**Cause:** The HP All-in-One is set up to receive faxes manually, which means that the HP All-in-One will not answer incoming calls. You must be available to respond in person to incoming fax calls, or the HP All-in-One will not receive the fax and your answering machine will record the fax tones.

**Solution:** Set up the HP All-in-One to answer incoming calls automatically by turning on **Auto Answer**. If it is turned off, the HP All-in-One will not monitor incoming calls and receive faxes. In this case, the answering machine will answer the fax call and record the fax tones.

For more information on setting up the HP All-in-One when you have an answering machine, see the printed documentation that came with the HP All-in-One.

---

### The HP All-in-One is not answering incoming fax calls

**Cause:** The HP All-in-One is turned off.

**Solution:** Look at the display on the HP All-in-One. If the display is blank and the **On** button is not lit, the HP All-in-One is turned off. Make sure the power cord is firmly connected to the HP All-in-One and plugged into a power outlet. Press the **On** button to turn on the HP All-in-One.

---

**Cause:** **Auto Answer** is turned off, which means that the HP All-in-One will not answer incoming calls. You must be available to respond in person to incoming fax calls, or the HP All-in-One will not answer the incoming fax call.

**Solution:** Depending on your office setup, you might be able to set the HP All-in-One to answer incoming calls automatically. To find out what the recommended answer mode is for your office setup, see the printed documentation that came with the HP All-in-One.

If you must have **Auto Answer** off, you will need to press **Start Fax Black** or **Start Fax Color** to receive a fax.

---

 **TIP:** If you are not close enough to the HP All-in-One to reach the control panel, wait several seconds, and then press **1 2 3** on your phone. If the HP All-in-One does not begin receiving the fax, wait several more seconds and press **1 2 3** again. After the HP All-in-One begins to receive the fax, you can hang up the phone.

---

**Cause:** You have a special ring pattern for your fax phone number (using a distinctive ring service through your telephone company), and the **Distinctive Ring** setting on the HP All-in-One does not match.

**Solution:** If you have a special ring pattern for your fax phone number (using a distinctive ring service through your telephone company), make sure that the **Distinctive Ring** feature on the HP All-in-One is set to match. For example, if the phone company has assigned your number a double ring pattern, make sure **Double Rings** is selected as the **Distinctive Ring** setting.

---

 **NOTE:** The HP All-in-One cannot recognize some ring patterns, such as those with alternating short and long ringing patterns. If you are having problems with a ring pattern of this type, ask your phone company to assign a non-alternating ring pattern.

---

If you are not using a distinctive ring service, check to make sure that the **Distinctive Ring** feature on the HP All-in-One is set to **All Rings**.

For more information, see:

[“Change the answer ring pattern for distinctive ringing” on page 63](#)

---

**Cause:** The **Distinctive Ring** feature is not set to **All Rings** (and you are not using a distinctive ring service).

**Solution:** If you are not using a distinctive ring service, check to make sure that the **Distinctive Ring** feature on the HP All-in-One is set to **All Rings**.

---

**Cause:** The memory of the HP All-in-One is full.

**Solution:** If the memory becomes full of faxes that have not yet been printed, the HP All-in-One stops answering calls. If an error condition exists that is preventing the HP All-in-One from printing faxes, review the display for information on the error condition. Also, check for the following problems:

- The HP All-in-One is not set up properly for faxing. See the printed documentation for information.
- There is no paper loaded in the input tray.
- There is a paper jam.
- The ink cartridge door is open. Close the ink cartridge door, as shown below:

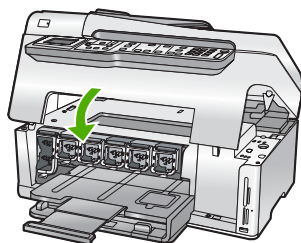

- The print head assembly is stalled. Turn the HP All-in-One off, remove any objects that are blocking the print head assembly (including any packing materials), and then turn the HP All-in-One on again.

---

 **NOTE:** If **Backup Fax Reception** is enabled and you turn off the HP All-in-One, all faxes stored in memory are deleted, including any unprinted faxes that you might have received while the HP All-in-One was in an error condition. You will need to contact the senders to ask them to resend any unprinted faxes. For a list of the faxes you have received, print the **Fax Log**. The **Fax Log** is not deleted when the HP All-in-One is turned off.

---



Resolve any problems found. To clear the memory, you can either print or delete the faxes stored in memory.

For more information, see:

[“Reprint received faxes from memory” on page 142](#)

**Cause:** An error condition is preventing the HP All-in-One from receiving faxes and **Backup Fax Reception** is set to **Off**.

**Solution:** Check for the following problems:

- The HP All-in-One is turned off. Press the **On** button to turn on the device.
- The HP All-in-One is not set up properly for faxing. See the printed documentation for information.
- There is no paper loaded in the input tray.
- There is a paper jam.
- The ink cartridge door is open. Close the ink cartridge door.
- The print head assembly is stalled. Turn the HP All-in-One off, remove any objects that are blocking the print head assembly (including any packing materials), and then turn the HP All-in-One on again.

After you resolve any problems found, the HP All-in-One can begin answering incoming fax calls.

### Pages of a fax I received are missing

**Cause:** The paper is not loaded correctly in the input tray.

**Solution:** Make sure you have paper loaded correctly.

If you have **Backup Fax Reception** enabled, the HP All-in-One might have stored the fax in memory upon reception. After you have correctly loaded the paper in the input tray, the HP All-in-One automatically begins printing all the unprinted faxes from memory, in the order they were received. If you do not have **Backup Fax Reception** enabled, or if the fax was not stored in memory for some reason (for example, if the HP All-in-One was out of memory), you will need to contact the sender and ask for the fax to be resent.

For more information, see:

[“Load full-size paper” on page 76](#)

**Cause:** The sending fax machine is having problems.

**Solution:** Check with the sender to find out how many pages were sent. The sending fax machine might have failed to feed each page of the original.

### Faxes are received but do not print

**Cause:** The HP All-in-One has a paper jam or is out of paper.

**Solution:** If you have **Backup Fax Reception** enabled, the HP All-in-One might have stored the fax in memory upon reception. After clearing the paper jam or loading

paper in the input tray, the HP All-in-One automatically begins printing all the unprinted faxes from memory, in the order they were received. If you do not have **Backup Fax Reception** enabled, or if the fax was not stored in memory for some reason (for example, if the HP All-in-One was out of memory), ask the sender to resend the fax.

For more information, see:

[“Clear paper jams” on page 171](#)

---

**Cause:** Another process has caused an error in the HP All-in-One.

**Solution:** Check the display or your computer for an error message providing information about the problem and how to solve it. If there is an error, the HP All-in-One will not print the fax until the error condition is resolved.

You can also check the status of the HP All-in-One by clicking **Status** in the HP Solution Center.

For more information, see:

[“The fax log report shows an error” on page 256](#)

---

**Cause:** The ink cartridges might be out of ink.

**Solution:** Check the estimated ink levels in the ink cartridges. If the ink levels are low, you might need to replace the ink cartridges.

If there is ink remaining in the ink cartridges, but you are still noticing a problem, print a self-test report to determine if there is a problem with the ink cartridges. If the self-test report shows a problem, clean the ink cartridges. If the problem persists, you might need to replace the ink cartridges.

For more information, see:

[“Maintain the HP All-in-One” on page 155](#)

---

**Cause:** The print head assembly is stalled.

**Solution:** Turn the HP All-in-One off, remove any objects that are blocking the print head assembly (including any packing materials), and then turn the HP All-in-One on again.

 **NOTE:** If **Backup Fax Reception** is enabled and you turn off the HP All-in-One, all faxes stored in memory are deleted, including any unprinted faxes that you might have received while the HP All-in-One was in an error condition. You will need to contact the senders to ask them to resend any unprinted faxes. For a list of the faxes you have received, print the **Fax Log**. The **Fax Log** is not deleted when the HP All-in-One is turned off.

---

### Parts of a fax I received are cut off

**Cause:** The sending fax machine has a problem.

**Solution:** Check with the sender to see if the sending fax machine is having problems.

---

**Cause:** The fax originated on a larger paper size, such as legal, and the **Automatic Reduction** option is turned off.

**Solution:** You can print the fax on legal-size paper or you can set the **Automatic Reduction** feature to reduce the image so, if possible, it fits on one page.

---

**Cause:** The paper-width guide is not positioned correctly.

**Solution:** Make sure you have paper loaded correctly.

For more information, see:

[“Load paper” on page 76](#)

---

**Cause:** A legal-size fax was sent that contained very fine detail, such as large graphics, and letter-size paper is loaded in the input tray.

**Solution:** If a legal-size fax was sent that contained very fine detail, such as large graphics, the HP All-in-One will attempt to fit the fax on one page (if automatic reduction is enabled). If the memory is full, the HP All-in-One might not be able to reduce the image, causing it to be cut off and printed on a second page. You can clear the memory and have the sender resend the fax.

---

 **NOTE:** Clearing the memory will delete all faxes that are stored in memory, including any faxes that have not been printed. You might want to print all faxes in memory to make sure you do not lose any information.

---

For more information, see:

[“Reprint received faxes from memory” on page 142](#)

---

**Cause:** The paper loaded in the input tray is a different size than the **Fax Paper Size** setting.

**Solution:** Make sure the paper loaded in the input tray matches the **Fax Paper Size** setting.

---

### The computer to which I am connecting has only one phone port

**Cause:** I am setting up the HP All-in-One on a shared voice/fax line with a computer dial-up modem, and the computer has only one phone port.

**Solution:** If your computer has only one phone port, you will need to purchase a parallel splitter (also called a coupler), as shown below. (A parallel splitter has one RJ-11 port on the front and two RJ-11 ports on the back. Do not use a 2-line phone splitter, a serial splitter, or a parallel splitter which has two RJ-11 ports on the front and a plug on the back.)

**NOTE:** This possible solution applies only in the countries/regions that receive a 2-wire phone cord in the box with the HP All-in-One, including: Argentina, Australia, Brazil, Canada, Chile, China, Colombia, Greece, India, Indonesia, Ireland, Japan, Korea, Latin America, Malaysia, Mexico, Philippines, Poland, Portugal, Russia, Saudi Arabia, Singapore, Spain, Taiwan, Thailand, USA, Venezuela, and Vietnam.



**Figure 15-1 Example of a parallel splitter**

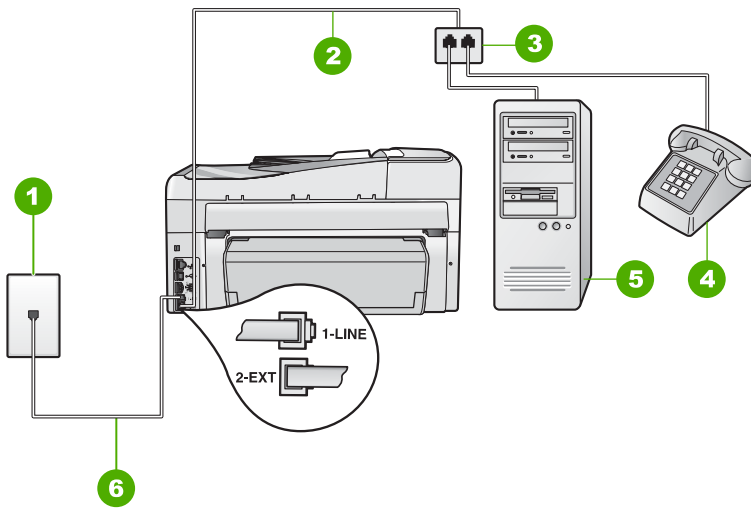

**Figure 15-2 Back view of the HP All-in-One**

1	Telephone wall jack
2	Phone cord connected to the 2-EXT port
3	Parallel splitter
4	Telephone (optional)
5	Computer with modem
6	Phone cord supplied in the box with the HP All-in-One connected to the 1-LINE port

### To set up the HP All-in-One to a computer with one phone port

1. Find the phone cord that connects from the back of your computer (your computer dial-up modem) to a telephone wall jack. Disconnect the cord from the telephone wall jack and plug it into the port labeled 2-EXT on the back of the HP All-in-One.
2. Using the phone cord supplied in the box with the HP All-in-One, connect one end to your telephone wall jack, then connect the other end to the port labeled 1-LINE on the back of the HP All-in-One.

---

 **NOTE:** If you do not use the supplied cord to connect from the telephone wall jack to the HP All-in-One, you might not be able to fax successfully. This special phone cord is different from the phone cords you might already have in your home or office.

---

3. Remove the white plug from the port labeled 2-EXT on the back of the HP All-in-One.
4. Using another phone cord, connect one end to the port labeled 2-EXT on the back of the HP All-in-One. Connect the other end of the phone cord to the parallel splitter on the side with the single phone port.
5. Unplug your computer modem from the telephone wall jack, and connect it to the parallel splitter on the side with two phone ports.
6. If your modem software is set to receive faxes to your computer automatically, turn off that setting.

---

 **NOTE:** If you do not turn off the automatic fax reception setting in your modem software, the HP All-in-One will not be able to receive faxes.

---

7. (Optional) Connect a phone to the other open phone port on the parallel splitter.
8. Now you need to decide how you want the HP All-in-One to answer calls, automatically or manually:
  - If you set up the HP All-in-One to answer calls **automatically**, it answers all incoming calls and receives faxes. The HP All-in-One will not be able to distinguish between fax and voice calls in this case; if you suspect the call is a voice call, you will need to answer it before the HP All-in-One answers the call. To set up the HP All-in-One to answer calls automatically, turn on the **Auto Answer** setting.
  - If you set up the HP All-in-One to answer faxes **manually**, you must be available to respond in person to incoming fax calls or the HP All-in-One cannot receive faxes. To set up the HP All-in-One to answer calls manually, turn off the **Auto Answer** setting.
9. Run a fax test.

If you pick up the phone before the HP All-in-One answers the call and hear fax tones from a sending fax machine, you will need to answer the fax call manually.

---

**Cause:** I am setting up the HP All-in-One on a shared voice/fax line with a computer dial-up modem and answering machine, and the computer only has one phone port.

**Solution:** If your computer has only one phone port, you will need to purchase a parallel splitter (also called a coupler). (A parallel splitter has one RJ-11 port on the front and two RJ-11 ports on the back. Do not use a 2-line phone splitter, a serial

splitter, or a parallel splitter which has two RJ-11 ports on the front and a plug on the back.)

 **NOTE:** This possible solution applies only in the countries/regions that receive a 2-wire phone cord in the box with the HP All-in-One, including: Argentina, Australia, Brazil, Canada, Chile, China, Colombia, Greece, India, Indonesia, Ireland, Japan, Korea, Latin America, Malaysia, Mexico, Philippines, Poland, Portugal, Russia, Saudi Arabia, Singapore, Spain, Taiwan, Thailand, USA, Venezuela, and Vietnam.

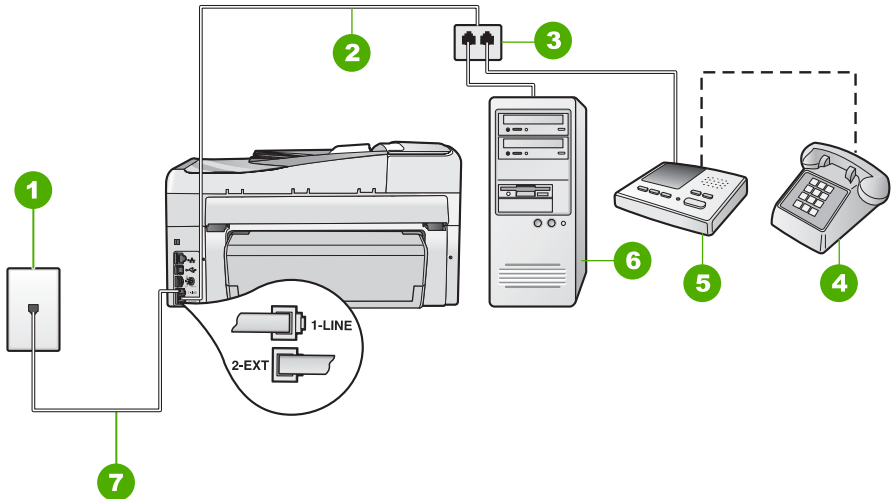

**Figure 15-3 Back view of the HP All-in-One**

1	Telephone wall jack
2	Phone cord connected to the 2-EXT port
3	Parallel splitter
4	Telephone (optional)
5	Answering machine
6	Computer with modem
7	Phone cord supplied in the box with the HP All-in-One connected to the 1-LINE port

### To set up the HP All-in-One to a computer with one phone port

1. Find the phone cord that connects from the back of your computer (your computer dial-up modem) to a telephone wall jack. Disconnect the cord from the telephone wall jack and plug it into the port labeled 2-EXT on the back of the HP All-in-One.
2. Using the phone cord supplied in the box with the HP All-in-One, connect one end to your telephone wall jack, then connect the other end to the port labeled 1-LINE on the back of the HP All-in-One.

---

 **NOTE:** If you do not use the supplied cord to connect from the telephone wall jack to the HP All-in-One, you might not be able to fax successfully. This special phone cord is different from the phone cords you might already have in your home or office.

---

3. Remove the white plug from the port labeled 2-EXT on the back of the HP All-in-One.
4. Using another phone cord, connect one end to the port labeled 2-EXT on the back of the HP All-in-One. Connect the other end of the phone cord to the parallel splitter on the side with the single phone port.
5. Unplug your computer modem from the telephone wall jack, and connect it to the parallel splitter on the side with two phone ports.
6. Connect your answering machine to the other open phone port on the parallel splitter.

---

 **NOTE:** If you do not connect your answering machine in this way, fax tones from a sending fax machine might be recorded on your answering machine, and you might not be able to receive faxes with the HP All-in-One.

---

7. (Optional) If your answering machine does not have a built-in phone, for convenience you might want to connect a phone to the back of your answering machine at the "OUT" port.
8. If your modem software is set to receive faxes to your computer automatically, turn off that setting.

---

 **NOTE:** If you do not turn off the automatic fax reception setting in your modem software, the HP All-in-One will not be able to receive faxes.

---

9. Turn on the **Auto Answer** setting.
10. Set your answering machine to answer after a low number of rings.
11. Change the **Rings to Answer** setting on the HP All-in-One to the maximum number of rings supported by your device. (The maximum number of rings varies by country/region.)
12. Run a fax test.

When the phone rings, your answering machine will answer after the number of rings you have set, and then play your recorded greeting. The HP All-in-One monitors the call during this time, "listening" for fax tones. If incoming fax tones are detected, the HP All-in-One will emit fax reception tones and receive the fax; if there are no fax tones, the HP All-in-One stops monitoring the line and your answering machine can record a voice message.

---

**Cause:** I am setting up the HP All-in-One on a shared voice/fax line with a computer dial-up modem and voice mail service, and the computer has only one phone port.

**Solution:** If your computer has only one phone port, you will need to purchase a parallel splitter (also called a coupler). (A parallel splitter has one RJ-11 port on the front and two RJ-11 ports on the back. Do not use a 2-line phone splitter, a serial splitter, or a parallel splitter which has two RJ-11 ports on the front and a plug on the back.)

 **NOTE:** This possible solution applies only in the countries/regions that receive a 2-wire phone cord in the box with the HP All-in-One, including: Argentina, Australia, Brazil, Canada, Chile, China, Colombia, Greece, India, Indonesia, Ireland, Japan, Korea, Latin America, Malaysia, Mexico, Philippines, Poland, Portugal, Russia, Saudi Arabia, Singapore, Spain, Taiwan, Thailand, USA, Venezuela, and Vietnam.

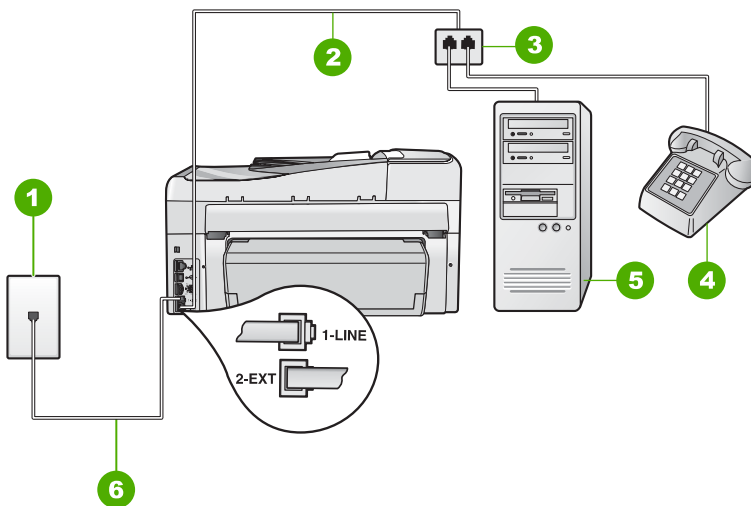

**Figure 15-4 Back view of the HP All-in-One**

1	Telephone wall jack
2	Phone cord connected to the 2-EXT port
3	Parallel splitter
4	Telephone (optional)
5	Computer with modem
6	Phone cord supplied in the box with the HP All-in-One connected to the 1-LINE port



### To set up the HP All-in-One to a computer with one phone port

1. Find the phone cord that connects from the back of your computer (your computer dial-up modem) to a telephone wall jack. Disconnect the cord from the telephone wall jack and plug it into the port labeled 2-EXT on the back of the HP All-in-One.
2. Using the phone cord supplied in the box with the HP All-in-One, connect one end to your telephone wall jack, then connect the other end to the port labeled 1-LINE on the back of the HP All-in-One.

---

 **NOTE:** If you do not use the supplied cord to connect from the telephone wall jack to the HP All-in-One, you might not be able to fax successfully. This special phone cord is different from the phone cords you might already have in your home or office.

---

3. Remove the white plug from the port labeled 2-EXT on the back of the HP All-in-One.
4. Using another phone cord, connect one end to the port labeled 2-EXT on the back of the HP All-in-One. Connect the other end of the phone cord to the parallel splitter on the side with the single phone port.
5. Unplug your computer modem from the telephone wall jack, and connect it to the parallel splitter on the side with two phone ports.
6. If your modem software is set to receive faxes to your computer automatically, turn off that setting.

---

 **NOTE:** If you do not turn off the automatic fax reception setting in your modem software, the HP All-in-One will not be able to receive faxes.

---

7. (Optional) Connect a phone to the other open phone port on the parallel splitter.
8. Turn off the **Auto Answer** setting.
9. Run a fax test.

If you pick up the phone before the HP All-in-One answers the call and hear fax tones from a sending fax machine, you will need to answer the fax call manually.

---

### I hear static on my telephone line since connecting the HP All-in-One

**Cause:** The HP All-in-One is not set up properly for faxing.

#### **Solution:**

---

 **NOTE:** This possible solution applies only in the countries/regions that receive a 2-wire phone cord in the box with the HP All-in-One, including: Argentina, Australia, Brazil, Canada, Chile, China, Colombia, Greece, India, Indonesia, Ireland, Japan, Korea, Latin America, Malaysia, Mexico, Philippines, Poland, Portugal, Russia, Saudi Arabia, Singapore, Spain, Taiwan, Thailand, USA, Venezuela, and Vietnam.

---

Connect the HP All-in-One to a working telephone wall jack. Make sure you used the phone cord supplied in the box with the HP All-in-One. Connect the 2-wire phone cord

to the port labeled 1-LINE on the back of the HP All-in-One and to your telephone wall jack, as shown below.

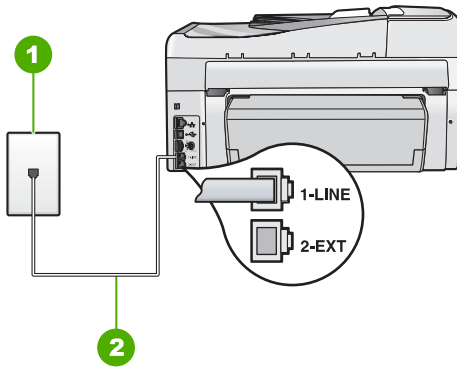

1	Telephone wall jack
2	Use the phone cord supplied in the box with the HP All-in-One

This special 2-wire phone cord is different from the more common 4-wire phone cords you might already have in your office. Check the end of the cord and compare it to the two types of cords shown below.

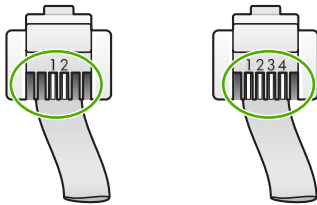

If you used a 4-wire phone cord, disconnect it, find the supplied 2-wire phone cord, and then connect the 2-wire phone cord to the port labeled 1-LINE on the back of the HP All-in-One.

If the HP All-in-One came with a 2-wire phone cord adaptor, you can use it with a 4-wire phone cord, in case the supplied 2-wire phone cord is too short. Attach the 2-wire phone cord adaptor to the port labeled 1-LINE on the back of the HP All-in-One. Attach your 4-wire phone cord to the open port on the adaptor and to the telephone wall jack. For more information on using the 2-wire phone cord adaptor, see the documentation that came with it.

For more information on setting up the HP All-in-One, see the printed documentation that came with the HP All-in-One.

**Cause:** You are using a phone line splitter between the 1-LINE port on the HP All-in-One and the wall.

**Solution:** A phone line splitter can affect the sound quality of your phone line and cause static. (A splitter is a two-cord connector that plugs into a telephone wall jack.)

Try removing the splitter and connecting the HP All-in-One directly to the telephone wall jack.

---

**Cause:** You are not using a proper grounded power outlet for the HP All-in-One.

**Solution:** Try connecting to another power outlet.

---

### The fax test failed

If you tried to run the fax test from your computer and the fax test failed to run, the HP All-in-One might be busy with another task or have an error condition preventing it from running the fax test.

#### What to check

- The HP All-in-One is set up properly, connected to a power supply, and is connected to your computer. For more information on setting up the HP All-in-One, see the Setup Guide that came with the HP All-in-One.
- The HP All-in-One is turned on. If it is not, press the **On** button to turn on the HP All-in-One.
- The ink cartridges are installed correctly, the print head assembly is not blocked, and the ink cartridge door is closed.
- The HP All-in-One is not currently busy with another task such as aligning the printer. Check the display. If the HP All-in-One is busy, wait until it completes the current task and run the fax test again.
- The Two-sided printing accessory is attached to the back of the HP All-in-One.
- There are no error messages on the display. If there is an error message, resolve the problem and run the fax test again.

If you run the fax test and the HP All-in-One reports that the test failed, read the following information carefully to determine how to correct any problems with your fax setup. Different portions of the fax test might fail for different reasons.

**Cause:** The "Fax Hardware Test" failed.

## Solution:

### What to do

- Turn off the HP All-in-One by using the **On** button located on the control panel and then unplug the power cord from the back of the HP All-in-One. After a few seconds, plug the power cord back in and turn the power on. Run the test again. If the test fails again, continue reviewing the troubleshooting information in this section.



**NOTE:** Depending how long the HP All-in-One is unplugged, the date and time might be erased. You might need to reset the date and time later, when you plug the power cord back in.

---

- Try to send or receive a test fax. If you can send or receive a fax successfully, there might not be a problem.
- If you are running the test from the **Fax Setup Wizard**, make sure the HP All-in-One is not busy completing another task, such as making a copy. Check the display for a message indicating that the HP All-in-One is busy. If it is busy, wait until it is finished and in the idle state, before running the test.

After you resolve any problems found, run the fax test again to make sure it passes and the HP All-in-One is ready for faxing. If the **Fax Hardware Test** continues to fail and you experience problems faxing, contact HP Support. Go to [www.hp.com/support](http://www.hp.com/support). If prompted, choose your country/region, and then click **Contact HP** for information on calling for technical support.

---

**Cause:** The "Fax Connected to Active Telephone Wall Jack" test failed.

## Solution:

### What to do

- Check the connection between the telephone wall jack and the HP All-in-One to make sure the phone cord is secure.
- Make sure you use the phone cord that came with the HP All-in-One. If you do not use the supplied phone cord to connect from the telephone wall jack to the HP All-in-One, you might not be able to send or receive faxes. After you plug in the phone cord that came with the HP All-in-One, run the fax test again.
- Make sure you have correctly connected the HP All-in-One to the telephone wall jack. Using the phone cord supplied in the box with the HP All-in-One, connect one end to your telephone wall jack, then connect the other end to the port labeled

1-LINE on the back of the HP All-in-One. For more information on setting up the HP All-in-One for faxing, see the printed documentation.

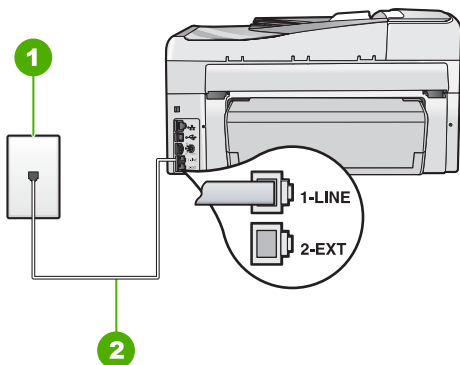

1	Telephone wall jack
2	Use the phone cord supplied in the box with the HP All-in-One

- If you are using a phone splitter, this can cause faxing problems. (A splitter is a two-cord connector that plugs into a telephone wall jack.) Try removing the splitter and connecting the HP All-in-One directly to the telephone wall jack.
- Try connecting a working phone and phone cord to the telephone wall jack that you are using for the HP All-in-One and check for a dial tone. If you do not hear a dial tone, contact your telephone company and have them check the line.
- Try to send or receive a test fax. If you can send or receive a fax successfully, there might not be a problem.

After you resolve any problems found, run the fax test again to make sure it passes and the HP All-in-One is ready for faxing.

**Cause:** The "Phone Cord Connected to Correct Port on Fax" test failed.

**Solution:** Plug the phone cord into the correct port.

#### What to do

1. Using the phone cord supplied in the box with the HP All-in-One, connect one end to your telephone wall jack, then connect the other end to the port labeled 1-LINE on the back of the HP All-in-One.

 **NOTE:** If you use the 2-EXT port to connect to the telephone wall jack, you will not be able to send or receive faxes. The 2-EXT port should only be used to connect other equipment, such as an answering machine or a telephone.

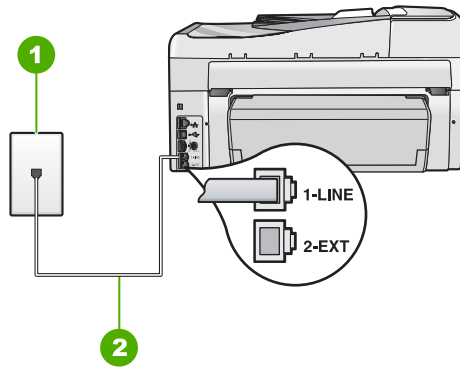

1	Telephone wall jack
2	Use the phone cord supplied in the box with the HP All-in-One

2. After you have connected the phone cord to the port labeled 1-LINE, run the fax test again to make sure it passes and the HP All-in-One is ready for faxing.
3. Try to send or receive a test fax.

**Cause:** The "Using Correct Type of Phone Cord with Fax" test failed.

**Solution:**

**What to do**

- Make sure you used the phone cord supplied in the box with the HP All-in-One to connect to the telephone wall jack. One end of the phone cord should be connected to the port labeled 1-LINE on the back of the HP All-in-One and the other end to your telephone wall jack, as shown below.

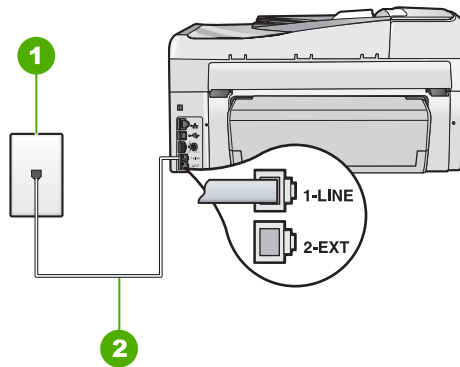

1	Telephone wall jack
2	Phone cord supplied in the box with the HP All-in-One

- Check the connection between the telephone wall jack and the HP All-in-One to make sure the phone cord is secure.

---

**Cause:** The "Fax Line Condition" test failed.

**Solution:**

**What to do**

- Make sure you connect the HP All-in-One to an analog phone line or you will not be able to send or receive faxes. To check if your phone line is digital, connect a regular analog phone to the line and listen for a dial tone. If you do not hear a normal sounding dial tone, it might be a phone line set up for digital phones. Connect the HP All-in-One to an analog phone line and try sending or receiving a fax.
- Check the connection between the telephone wall jack and the HP All-in-One to make sure the phone cord is secure.
- Make sure you have correctly connected the HP All-in-One to the telephone wall jack. Using the phone cord supplied in the box with the HP All-in-One, connect one end to your telephone wall jack, then connect the other end to the port labeled 1-LINE on the back of the HP All-in-One. For more information on setting up the HP All-in-One for faxing, see the User Guide.
- Other equipment, which uses the same phone line as the HP All-in-One, might be causing the test to fail. To find out if other equipment is causing a problem, disconnect everything except the HP All-in-One from the phone line, and then run the test again.
  - If the **Fax Line Condition Test** passes without the other equipment, then one or more pieces of the equipment is causing problems; try adding them back one at a time and rerunning the test each time, until you identify which piece of equipment is causing the problem.
  - If the **Fax Line Condition Test** fails without the other equipment, connect the HP All-in-One to a working phone line and continue reviewing the troubleshooting information in this section.
- If you are using a phone splitter, this can cause faxing problems. (A splitter is a two-cord connector that plugs into a telephone wall jack.) Try removing the splitter and connecting the HP All-in-One directly to the telephone wall jack.

After you resolve any problems found, run the fax test again to make sure it passes and the HP All-in-One is ready for faxing. If the **Fax Line Condition Test** continues to fail and you experience problems faxing, contact your telephone company and have them check the phone line.

---

**Cause:** The "Dial Tone Detection" test failed.

## Solution:

### What to do

- Other equipment, which uses the same phone line as the HP All-in-One, might be causing the test to fail. To find out if other equipment is causing a problem, disconnect everything except the HP All-in-One from the phone line, and then run the test again. If the **Dial Tone Detection Test** passes without the other equipment, then one or more pieces of the equipment is causing problems; try adding them back one at a time and rerunning the test each time, until you identify which piece of equipment is causing the problem.
- Try connecting a working phone and phone cord to the telephone wall jack that you are using for the HP All-in-One and check for a dial tone. If you do not hear a dial tone, contact your telephone company and have them check the line.
- Make sure you have correctly connected the HP All-in-One to the telephone wall jack. Using the phone cord supplied in the box with the HP All-in-One, connect one end to your telephone wall jack, then connect the other end to the port labeled 1-LINE on the back of the HP All-in-One. For more information on setting up the HP All-in-One for faxing, see the printed documentation that came with the HP All-in-One.

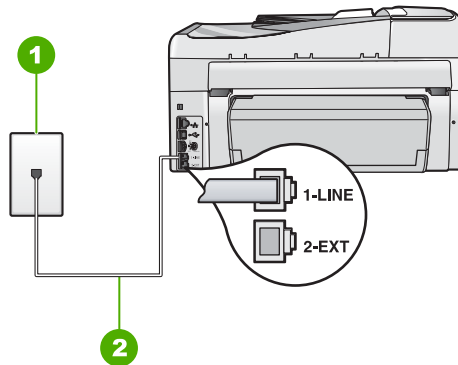

1	Telephone wall jack
2	Use the phone cord supplied in the box with the HP All-in-One

- If you are using a phone splitter, this can cause faxing problems. (A splitter is a two-cord connector that plugs into a telephone wall jack.) Try removing the splitter and connecting the HP All-in-One directly to the telephone wall jack.
- If your telephone system is not using a standard dial tone, such as some PBX systems, this might cause the test to fail. This will not cause a problem sending or receiving faxes. Try sending or receiving a test fax.



- Check to make sure the country/region setting is set appropriately for your country/region. If the country/region setting is not set or is set incorrectly, the test might fail and you might have problems sending and receiving faxes.
- Make sure you connect the HP All-in-One to an analog phone line or you will not be able to send or receive faxes. To check if your phone line is digital, connect a regular analog phone to the line and listen for a dial tone. If you do not hear a normal sounding dial tone, it might be a phone line set up for digital phones. Connect the HP All-in-One to an analog phone line and try sending or receiving a fax.

After you resolve any problems found, run the fax test again to make sure it passes and the HP All-in-One is ready for faxing. If the **Dial Tone Detection Test** continues to fail, contact your telephone company and have them check the phone line.

### I am having problems faxing over the Internet using IP phone

**Cause:** The fax over Internet Protocol (FoIP) service might not work properly when the HP All-in-One is sending and receiving faxes at high speed (33600 bps).

**Solution:** If you experience problems sending and receiving faxes while using an Internet fax service, use a slower fax speed. You can do this by changing the **Fax Speed** setting from **Fast (33600)** (the default) to **Medium (14400)** or **Slow (9600)**.

For more information, see:

[“Set the fax speed” on page 30](#)

**Cause:** The HP All-in-One is not set up properly for faxing.

**Solution:** You can only send and receive faxes by connecting a phone cord to the port labeled 1-LINE on the HP All-in-One and not from the Ethernet port. This means that your connection to the Internet must be done either through a converter box (which supplies regular analog phone jacks for fax connections) or your telephone company.

**Cause:** Your telephone company does not support faxing over the Internet.

**Solution:** Check with your telephone company to make sure their Internet phone service supports faxing. If they do not support faxing, you will not be able to send and receive faxes through the Internet.

### The fax log report shows an error

**Cause:** If there is a problem or error encountered during sending or receiving a fax, a **Fax Log** report will print.

**Solution:** Review the following table for information on the error codes in the **Fax Log** report. This information can help you troubleshoot any problems you encounter when using the fax features of the HP All-in-One. The table also indicates which codes

are specific to **Error Correction Mode (ECM)**. If the same error appears repeatedly, try turning off ECM.

<b>Error code</b>	<b>Error definition</b>
(223 <b>Error Correction Mode</b> ) 224	One or more received pages might not be readable.
225-231	There is a feature incompatibility with the sending fax machine.
232-234 (235-236 <b>Error Correction Mode</b> ) 237	The telephone connection was lost.
238 (239-241 <b>Error Correction Mode</b> )	The sending fax machine sent an unexpected communication.
242	The sending fax machine is attempting to receive instead of send.
243-244 (245-246 <b>Error Correction Mode</b> )	The sending fax machine prematurely ended the session.
247-248 (249-251 <b>Error Correction Mode</b> )	There was a communication error with the sending fax machine.
252	Telephone line conditions were too poor to receive a fax.
253	The sending fax machine attempted to use an unsupported page width.
281 (282 <b>Error Correction Mode</b> ) 283-284 (285 <b>Error Correction Mode</b> ) 286	The telephone connection was lost.
290	There was a communication error with the sending fax machine.
291	The received fax could not be stored.
314-320	There is a feature incompatibility with the receiving fax machine.
321	There was a communication error with the receiving fax machine.
322-324	Telephone line conditions were too poor to send a fax.
(325-328 <b>Error Correction Mode</b> ) 329-331	The receiving fax machine indicated one or more pages might not be readable.
332-337	The receiving fax machine sent an unexpected communication.

(continued)

Error code	Error definition
(338-342 Error Correction Mode) 343	
344-348 (349-353 Error Correction Mode) 354-355	The telephone connection was lost.
356-361 (362-366 Error Correction Mode)	The receiving fax machine prematurely ended the session.
367-372 (373-377 Error Correction Mode) 378-380	There was a communication error with the receiving fax machine.
381	The telephone connection was lost.
382	The receiving fax machine stopped accepting pages.
383	The telephone connection was lost.
390-391	There was a communication error with the receiving fax machine.

For more information, see:

[“Send a fax in Error Correction Mode” on page 139](#)

## Errors

This section contains the following categories of messages on your device:

- [Device messages](#)
- [File messages](#)
- [General user messages](#)
- [Paper messages](#)
- [Power and connection messages](#)
- [Ink cartridge messages](#)

### Device messages

The following is a list of device-related error messages:

- [Automatic document feeder failed to load](#)
- [Automatic document feeder is jammed](#)
- [Firmware revision mismatch](#)
- [Mechanism error](#)
- [Memory is full](#)

- [Scanner failure](#)
- [Photo tray problem](#)
- [Photo tray cannot engage](#)
- [Photo tray cannot disengage](#)
- [Two-sided printing accessory is missing](#)

### Automatic document feeder failed to load

**Cause:** The automatic document feeder did not work properly, and the job did not finish.

**Solution:** Try loading the originals in the automatic document feeder again, and restart the job. Do not load more than 50 sheets of letter or A4 paper, or 35 sheets of legal paper in the document feeder tray.

For more information, see:

[“Load an original in the automatic document feeder” on page 71](#)

---

### Automatic document feeder is jammed

**Cause:** Paper has jammed the automatic document feeder.

**Solution:** Clear the paper jam and try the job again. Do not load more than 50 sheets of letter or A4 paper, or 35 sheets of legal paper in the document feeder tray.

For more information, see:

[“Clear paper jams” on page 171](#)

---

### Firmware revision mismatch

**Cause:** The revision number of the HP All-in-One firmware does not match the revision number of the software.

**Solution:** To find support and warranty information, go to the HP Web site at [www.hp.com/support](http://www.hp.com/support). If prompted, choose your country/region, and then click

**Contact HP** for information on calling for technical support.

---

### Mechanism error

**Cause:** The HP All-in-One has a paper jam.

**Solution:** Clear the paper jam.

For more information, see:

[“Clear paper jams” on page 171](#)

---

**Cause:** The print head assembly is blocked or stalled.

**Solution:** Turn the HP All-in-One off and open the ink cartridge door. Remove any objects that are blocking the print head assembly (including any packing materials), and then turn the HP All-in-One on again.

---

### Memory is full

**Cause:** While receiving a fax, the HP All-in-One jammed with paper or ran out of paper.

**Solution:** If the HP All-in-One supports faxing and you have **Backup Fax Reception** enabled, the HP All-in-One might have stored the fax in memory upon reception.

After clearing the paper jam or loading paper in the input tray, you might be able to reprint the entire fax from memory. If you do not have **Backup Fax Reception** enabled, or if the fax was not stored in memory for some reason (for example, if the HP All-in-One was out of memory), you will need to contact the sender and ask for the fax to be resent.

For more information, see:

- [“Clear paper jams” on page 171](#)
- [“Load paper” on page 76](#)
- [“Reprint received faxes from memory” on page 142](#)

**Cause:** The document you are copying has exceeded the memory of the HP All-in-One.

**Solution:** Try making fewer copies or, in the case of a multi-page document, copy fewer pages at a time.

### Scanner failure

**Cause:** The HP All-in-One is busy or an unknown cause has interrupted your scan.

**Solution:** Turn off the HP All-in-One and then turn it on again. Restart your computer and then try to scan again.

If the problem persists, try plugging the power cord directly into a grounded power outlet rather than a surge protector or power strip. If the problem continues, contact HP Support. Go to [www.hp.com/support](http://www.hp.com/support). If prompted, choose your country/region, and then click **Contact HP** for information on calling for technical support.

### Photo tray problem

**Cause:** There is not enough paper in the photo tray.

**Solution:** If the photo tray is empty or there are only a few sheets remaining, load more paper in the photo tray. If there is paper in the photo tray, remove the paper, tap the stack of paper against a flat surface, and reload the paper into the photo tray. Follow the prompts on the display or the computer screen to continue your print job.

**Cause:** The paper is not feeding properly or is loaded incorrectly.

**Solution:** Make sure you have paper loaded correctly in the photo tray.

**Cause:** There might be too much paper loaded in the photo tray.

**Solution:** Do not overload the photo tray; make sure the stack of photo paper fits within the photo tray and is no higher than the top of the paper-width guide.

---

**Cause:** Two or more pieces of paper might be stuck together.

**Solution:** Remove the paper from the photo tray and shuffle the paper so it does not stick together. Reload the paper into the photo tray and try printing again.

---

**Cause:** The photo paper might be curled.

**Solution:** If the photo paper is curled, place the paper in a plastic bag and gently bend it the opposite direction of the curl until the paper lies flat. If the problem persists, use photo paper that is not curled.

---

**Cause:** You might be using the printer in an extremely high- or low-humidity environment.

**Solution:** Load one sheet of photo paper at a time.

---

### Photo tray cannot engage

**Cause:** The photo tray might not be pushed all the way in.

**Solution:** Lift the output tray, then push the photo tray all the way in. Push the output tray all the way down.

---

### Photo tray cannot disengage

**Cause:** The output tray might not be lowered all the way.

**Solution:** Push the output tray all the way down.

---

### Two-sided printing accessory is missing

**Cause:** The Two-sided printing accessory is not installed or it is installed incorrectly.

**Solution:** Firmly insert the Two-sided printing accessory into the back of the device until both sides snap into place.

---

 **NOTE:** Do not press the buttons on either side of the accessory when installing it. Use the buttons only when removing the accessory from the device.

---

## File messages

The following is a list of file-related error messages:

- [Error reading or writing the file](#)
- [Unreadable files. NN files could not be read](#)
- [Photos not found](#)
- [File not found](#)

- [File format not supported](#)
- [Invalid file name](#)
- [Supported file types for the HP All-in-One](#)
- [File corrupted](#)

### Error reading or writing the file

**Cause:** The HP All-in-One software could not open or save the file.

**Solution:** Check to see if you typed the correct folder and file name.

---

### Unreadable files. NN files could not be read

**Cause:** Some of the files on the inserted memory card or attached storage device are damaged.

**Solution:** Reinsert the memory card in the HP All-in-One or try transferring the files to your computer using a memory card reader or a USB cable. If you already transferred the files to your computer, try printing those files by using the HP Photosmart Software. The copies might not be damaged. If these solutions do not work, retake the photos with your digital camera as a last resort.

---

### Photos not found

**Cause:** Some of the files on the inserted memory card or attached storage device are damaged.

**Solution:** Reinsert the memory card in the HP All-in-One or try transferring the files to your computer using a memory card reader or a USB cable. If you already transferred the files to your computer, try printing those files by using the HP Photosmart Software. The copies might not be damaged. If these solutions do not work, retake the photos with your digital camera as a last resort.

---

**Cause:** There are no photos found on the memory card or storage device.

**Solution:** Take some photos with your digital camera, or if you previously saved photos on your computer, you can print them using the HP Photosmart Software.

---

### File not found

**Cause:** There is not enough available memory on your computer to create a print preview file.

**Solution:** Close some applications and try the task again.

---

### File format not supported

**Cause:** The HP All-in-One software did not recognize or support the file format of the image you are trying to open or save. If the file extension indicates it is a supported file type, the file might be corrupted.

**Solution:** Open the file in another application, and save it in a format that the HP All-in-One software recognizes.

For more information, see:

[“Supported file types for the HP All-in-One” on page 263](#)

---

### Invalid file name

**Cause:** The file name you entered is invalid.

**Solution:** Make sure that you are not using any invalid symbols in the file name.

 **NOTE:** Although the file name might look correct, it could still include invalid characters. Overwrite the existing file name with a new name.

---

### Supported file types for the HP All-in-One

The HP All-in-One software recognizes the following file formats: BMP, DCX, FPX, GIF, JPG, PCD, PCX, and TIF.

### File corrupted

**Cause:** Some of the files on the inserted memory card or attached storage device are damaged.

**Solution:** Reinsert the memory card in the HP All-in-One or try transferring the files to your computer using a memory card reader or a USB cable. If you already transferred the files to your computer, try printing those files by using the HP Photosmart Software. The copies might not be damaged. If these solutions do not work, retake the photos with your digital camera as a last resort.

---

**Cause:** The file system is corrupted.

**Solution:** Check the display for an error message telling you that the images on the memory card or storage device are corrupted.

If the file system on the card is corrupt, reformat the memory card in your digital camera.

---

 **CAUTION:** Reformatting the memory card will delete any photos stored on the card. If you have previously transferred the photos from your memory card to a computer, try printing the photos from the computer. Otherwise, you will need to retake any photos you might have lost.

---

### General user messages

The following is a list of messages related to common user errors:

- [Cannot crop](#)
- [Memory card error](#)
- [Disconnected](#)



- [No scan options](#)
- [Out of disk space](#)
- [Memory card must be in slot](#)
- [Card access error](#)
- [Use only one card at a time](#)
- [Card is inserted incorrectly](#)
- [Card is not fully inserted](#)
- [Card is damaged](#)
- [Duplicate group speed dial name](#)
- [Duplicate member](#)
- [Invalid speed dial](#)

### Cannot crop

**Cause:** The computer does not have enough memory.

**Solution:** Close all unnecessary applications. This includes applications that run in the background, such as screensavers and virus checkers. (If you turn off your virus checker, remember to turn it back on after you finish.) Try restarting your computer to clear the memory. You might need to purchase more RAM. Refer to the documentation that came with your computer.

---

**Cause:** For scanning, there must be at least 50 MB of space available on your computer's hard disk.

**Solution:** Empty the Recycle Bin on your desktop. You might also need to remove files from the hard disk.

---

### Memory card error

**Cause:** There are two or more memory cards inserted into the HP All-in-One at the same time.

**Solution:** Remove all but one memory card. The HP All-in-One reads the remaining memory card and displays the first photo stored on the memory card.

---

**Cause:** You have inserted a Compact Flash memory card backwards or upside down.

**Solution:** Remove the memory card and reinsert it correctly. The front label of the Compact Flash card faces left.

---

**Cause:** You have not fully inserted the memory card.

**Solution:** Remove the memory card and reinsert it in the memory card slot until it stops.

---

## Disconnected

**Cause:** Several situations can cause this error message to appear.

- Your computer is not turned on.
- Your computer is not connected to the HP All-in-One.
- The software that came with the HP All-in-One was not installed correctly.
- The software that came with the HP All-in-One is installed, but it is not running.

**Solution:** Make sure your computer is turned on and is connected to the HP All-in-One. Also make sure you installed the software that came with the HP All-in-One.

For more information, see:

- [“Communication problems over a USB connection” on page 169](#)
  - [“Network troubleshooting” on page 183](#)
- 

## No scan options

**Cause:** The software that came with the HP All-in-One is not running, or has never been installed.

**Solution:** Make sure the software is installed and running. For more information, see the Setup Guide that came with the HP All-in-One.

---

## Out of disk space

**Cause:** There is not enough available memory on your computer to perform the task.

**Solution:** Close some applications and try the task again.

---

## Memory card must be in slot

**Cause:** The feature you are trying to use is only available when there is a memory card or storage device inserted in the HP All-in-One.

**Solution:** Make sure you fully insert a memory card into the appropriate slot on the HP All-in-One or connect a storage device to the front USB port, and then try the task again.

---

## Card access error

**Cause:** There are two or more memory cards inserted into the HP All-in-One at the same time.

**Solution:** Remove all but one memory card. The HP All-in-One reads the remaining memory card and displays the first photo stored on the memory card.

---

**Cause:** You have inserted a Compact Flash memory card backwards or upside down.

---

**Solution:** Remove the memory card and reinsert it correctly. The front label of the Compact Flash card faces left.

---

**Cause:** You have not fully inserted the memory card.

**Solution:** Remove the memory card and reinsert it in the memory card slot until it stops.

---

### Use only one card at a time

**Cause:** Multiple memory cards are inserted in the HP All-in-One.

**Solution:** You can insert only one memory card at a time.

If more than one memory card is inserted, the Attention light will blink rapidly, and an error message will appear on the display. Remove the additional memory card to resolve the problem.

---

### Card is inserted incorrectly

**Cause:** The card is inserted backwards or upside down.

**Solution:** Turn the memory card so that the front label faces left and the contacts are on the right, and then push the card forward into the appropriate slot until the Photo light turns on.

If the memory card is not inserted properly, the HP All-in-One will not respond and the Photo light (near the memory card slots) will not turn on.

After the memory card has been inserted properly, the Photo light will blink for a few seconds, and then remain lit.

---

### Card is not fully inserted

**Cause:** The card is not fully inserted.

**Solution:** Make sure you fully insert the memory card into the appropriate slot on the HP All-in-One.

If the memory card is not inserted properly, the HP All-in-One will not respond and the Photo light (near the memory card slots) will not turn on.

After the memory card has been inserted properly, the Photo light will blink for a few seconds, and then remain lit.

---

### Card is damaged

**Cause:** You formatted the card on a Windows XP computer. By default, Windows XP will format a memory card of 8 MB or less and 64 MB or more with the FAT32 format. Digital cameras and other devices use the FAT (FAT16 or FAT12) format and cannot recognize a FAT32 formatted card.

**Solution:** Reformat your memory card in your camera or format your memory card in a Windows XP computer by selecting the FAT format.

---

**Cause:** The file system is corrupted.

**Solution:** Check the display for an error message telling you that the images on the memory card are corrupted.

If the file system on the card is corrupt, reformat the memory card in your digital camera.

---

△ **CAUTION:** Reformatting the memory card will delete any photos stored on the card. If you have previously transferred the photos from your memory card to a computer, try printing the photos from the computer. Otherwise, you will need to retake any photos you might have lost.

---

### Duplicate group speed dial name

**Cause:** The name you are trying to assign to the group speed dial is already being used.

**Solution:** Specify a different name for the group speed dial.

---

### Duplicate member

**Cause:** The individual speed dial you are trying to add to the speed dial group is already included in the group.

**Solution:** Add a different user to the group speed dial or just save your changes to the group.

---

### Invalid speed dial

**Cause:** The speed dial failed to connect to a fax machine.

**Solution:** Try dialing the fax number manually. If this works, update the speed dial. If this does not work, contact the recipient to make sure you are dialing the correct number.

---

## Paper messages

The following is a list of paper-related error messages:

- [Cannot load paper from input tray](#)
- [Ink is drying](#)
- [Out of paper](#)
- [Paper jam, misfeed or blocked print head assembly](#)
- [Paper mismatch](#)
- [Wrong paper width](#)

### Cannot load paper from input tray

**Cause:** There is not enough paper in the input tray.

**Solution:** If the HP All-in-One is out of paper or there are only a few sheets remaining, load more paper in the input tray. If there is paper in the input tray, remove the paper, tap the stack of paper against a flat surface, and reload the paper into the input tray. Follow the prompts on the display or the computer screen to continue your print job.

For more information, see:

[“Load full-size paper” on page 76](#)

---

### Ink is drying

**Cause:** Transparencies and some other media require a drying time that is longer than normal.

**Solution:** Leave the sheet in the output tray until the message disappears. If it is necessary to remove the printed sheet before the message disappears, carefully hold the printed sheet on the underside or the edges, and place it on a flat surface to dry.

---

### Out of paper

**Cause:** There is not enough paper in the input tray.

**Solution:** If the HP All-in-One is out of paper or there are only a few sheets remaining, load more paper in the input tray. If there is paper in the input tray, remove the paper, tap the stack of paper against a flat surface, and reload the paper into the input tray. Follow the prompts on the display or the computer screen to continue your print job.

For more information, see:

[“Load full-size paper” on page 76](#)

---

**Cause:** The Two-sided printing accessory is not connected to the HP All-in-One.

**Solution:** If you removed the Two-sided printing accessory to clear a paper jam, replace it.

For more information, see:

[“Clear paper jams” on page 171](#)

---

### Paper jam, misfeed or blocked print head assembly

**Cause:** Paper has jammed the HP All-in-One.

**Solution:** Clear the jam. To continue your print job, press **OK** on the control panel of the HP All-in-One.

For more information, see:

[“Clear paper jams” on page 171](#)

---

**Cause:** The print head assembly is blocked.

**Solution:** Turn the HP All-in-One off and open the ink cartridge door. Remove any objects that are blocking the print head assembly (including any packing materials), and then turn the HP All-in-One on again.

---

### Paper mismatch

**Cause:** The print setting for the print job does not match the paper type or size loaded in the HP All-in-One.

**Solution:** Change the print setting or load the appropriate paper in the input tray.

For more information, see:

[“Change the print settings for the current job” on page 84](#)

[“Information on paper” on page 171](#)

---

### Wrong paper width

**Cause:** The print setting chosen for the print job does not match the paper loaded in the HP All-in-One.

**Solution:** Change the print setting or load the appropriate paper in the input tray.

For more information, see:

[“Information on paper” on page 171](#)

[“Change the print settings for the current job” on page 84](#)

[“Load paper” on page 76](#)

---

## Power and connection messages

The following is a list of power- and connection-related error messages:

- [Communication test failed](#)
- [HP All-in-One not found](#)
- [Improper shutdown](#)
- [Two-way communication lost](#)

### Communication test failed

**Cause:** The HP All-in-One is turned off.

**Solution:** Look at the display on the HP All-in-One. If the display is blank and the **On** button is not lit, the HP All-in-One is turned off. Make sure the power cord is firmly connected to the HP All-in-One and plugged into a power outlet. Press the **On** button to turn on the HP All-in-One.

---

**Cause:** The HP All-in-One is not connected to the computer.

**Solution:** If the HP All-in-One is not properly connected to the computer, communication errors can occur. Make sure the USB cable is securely connected to the HP All-in-One and the computer, as shown below.

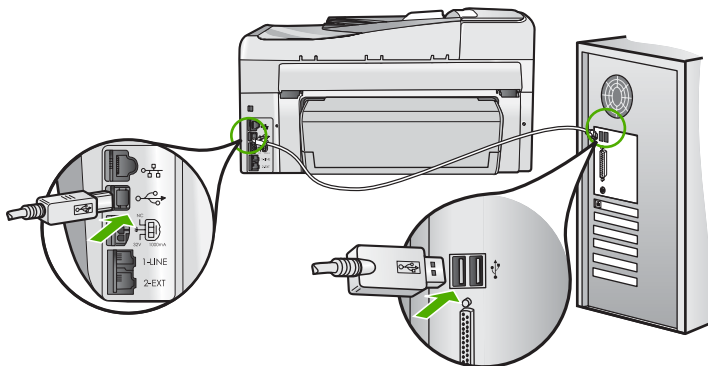

For more information, see:

[“Communication problems over a USB connection” on page 169](#)

### HP All-in-One not found

**Cause:** This error applies only to USB-connected devices. The USB cable is not plugged in properly.

**Solution:** If the HP All-in-One is not properly connected to the computer, communication errors can occur. Make sure the USB cable is securely connected to the HP All-in-One and the computer, as shown below.

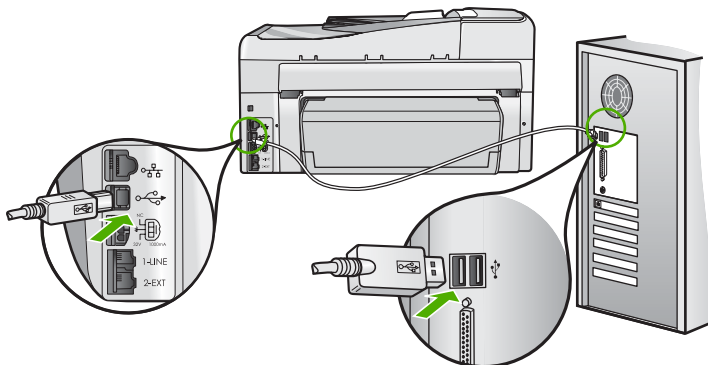

For more information, see:

[“Communication problems over a USB connection” on page 169](#)

## Improper shutdown

**Cause:** The last time the HP All-in-One was used, it was not turned off properly. If the HP All-in-One is turned off by turning off the switch on a power strip or by using a wall switch, the device can be damaged.

**Solution:** Press the **On** button located on the control panel of the HP All-in-One to turn the device on and off.

---

## Two-way communication lost

**Cause:** The HP All-in-One is turned off.

**Solution:** Look at the display on the HP All-in-One. If the display is blank and the **On** button is not lit, the HP All-in-One is turned off. Make sure the power cord is firmly connected to the HP All-in-One and plugged into a power outlet. Press the **On** button to turn on the HP All-in-One.

---

**Cause:** The HP All-in-One is not connected to the computer.

**Solution:** If the HP All-in-One is not properly connected to the computer, communication errors can occur. Make sure the USB cable is securely connected to the HP All-in-One and the computer, as shown below.

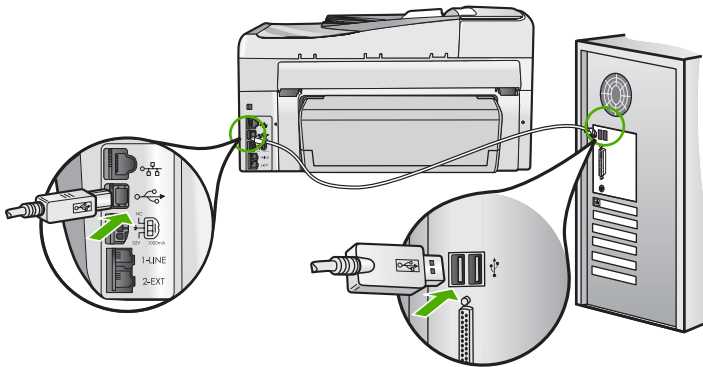

For more information, see:

[“Communication problems over a USB connection”](#) on page 169

---

## Ink cartridge messages

The following is a list of ink cartridge error messages:

- [Calibration error](#)
- [Cannot print](#)
- [Incorrect ink cartridge\(s\)](#)
- [The following ink cartridges cannot be used after device initialization and must be replaced](#)



- [Ink cartridge problem](#)
- [Ink cartridge\(s\) are empty](#)
- [Ink cartridge\(s\) are expired](#)
- [Ink delivery failure](#)
- [Ink expiration near](#)
- [Ink supply error](#)
- [Non-HP ink](#)
- [Original HP ink depleted](#)
- [Print head assembly is stalled](#)
- [Print head failure](#)
- [Alignment failed](#)
- [Replace ink cartridges soon](#)
- [Scheduled maintenance](#)
- [Wrong ink cartridge\(s\) installed](#)
- [Ink cartridge is missing, incorrectly installed, or not intended for your device](#)

### Calibration error

**Cause:** An incorrect type of paper is loaded in the input tray.

**Solution:** If you have color or photo paper loaded in the input tray when the printer aligns, the calibration might fail. Load unused plain white letter or A4 paper into the input tray, and then press **OK** on the control panel.

---

### Cannot print

**Cause:** The indicated ink cartridge(s) are out of ink.

**Solution:** Replace the indicated ink cartridge(s) immediately so that you can resume printing.

The HP All-in-One cannot continue printing until the indicated ink cartridge(s) are replaced. All printing will stop.

For more information, see:

[“Replace the ink cartridges” on page 159](#)

---

### Incorrect ink cartridge(s)

**Cause:** The wrong ink cartridge(s) are installed.

**Solution:** The indicated ink cartridge(s) cannot be used after the device has undergone first-time setup. Replace the ink cartridge(s) with the appropriate ink cartridges for the HP All-in-One. To find out the reorder number for all the ink cartridges that the HP All-in-One supports, see the printed documentation that came with the HP All-in-One.

For more information, see:

[“Replace the ink cartridges” on page 159](#)

---

**Cause:** The ink cartridge(s) are not intended for use in this device.

**Solution:** Contact HP support. Go to:

[www.hp.com/support](http://www.hp.com/support)

If prompted, choose your country/region, and then click **Contact HP** for information on calling for technical support.

---

### The following ink cartridges cannot be used after device initialization and must be replaced

**Cause:** The wrong ink cartridge(s) are installed.

**Solution:** The indicated ink cartridge(s) cannot be used after the device has undergone first-time setup. Replace the ink cartridge(s) with the appropriate ink cartridges for the HP All-in-One. To find out the reorder number for all the ink cartridges that the HP All-in-One supports, see the printed documentation that came with the HP All-in-One.

For more information, see:

[“Replace the ink cartridges” on page 159](#)

---

**Cause:** The ink cartridge(s) are not intended for use in this device.

**Solution:** Contact HP support. Go to:

[www.hp.com/support](http://www.hp.com/support)

If prompted, choose your country/region, and then click **Contact HP** for information on calling for technical support.

---

### Ink cartridge problem

**Cause:** The indicated ink cartridge(s) are missing or are damaged.

**Solution:** Replace the indicated ink cartridge(s) immediately so that you can resume printing. If there are no ink cartridges missing from the HP All-in-One, the ink cartridge contacts might need to be cleaned.

If there are no ink cartridges missing from the HP All-in-One, and you still receive this message after cleaning the ink cartridge contacts, you might have a damaged ink cartridge. Check to see if your ink cartridge is still under warranty and the end of warranty date has not been reached.

- If the end of warranty date has been reached, purchase a new ink cartridge.
- If the end of warranty date has not been reached, contact HP support. Go to [www.hp.com/support](http://www.hp.com/support). If prompted, choose your country/region, and then click **Contact HP** for information on calling for technical support.

For more information, see:

- [“Replace the ink cartridges” on page 159](#)
- [“Clean the ink cartridge contacts” on page 163](#)

- [“Ink cartridge warranty information”](#) on page 279
  - [“Shop for ink supplies”](#) on page 167
- 

### Ink cartridge(s) are empty

**Cause:** The indicated ink cartridge(s) are out of ink.

**Solution:** Replace the indicated ink cartridge(s) with new ink cartridge(s).

For more information, see:

[“Replace the ink cartridges”](#) on page 159

---

### Ink cartridge(s) are expired

**Cause:** The ink in the indicated ink cartridge(s) is at the expiration date.

**Solution:** Each ink cartridge has an expiration date. The purpose of expiration is to protect the printing system and to ensure ink quality. When you receive an ink cartridge(s) are expired message, remove and replace the expired ink cartridge, and then close the message. You can also continue printing without replacing the ink cartridge, by following the instructions on the HP All-in-One or the ink cartridge expiration message on your computer screen. HP recommends replacing the expired ink cartridges. HP cannot guarantee the quality or reliability of expired ink cartridges. Device service or repairs required as a result of using expired ink will not be covered under warranty.

For more information, see:

[“Replace the ink cartridges”](#) on page 159

---

### Ink delivery failure

**Cause:** The print head assembly or the ink delivery system has failed and the HP All-in-One can no longer print.

**Solution:** Turn the HP All-in-One off, unplug the power cord, and wait 10 seconds. Then, plug the power cord back in and turn the device on.

If you continue to receive this message, write down the error code provided in the message, and then contact HP support. Go to:

[www.hp.com/support](http://www.hp.com/support)

If prompted, choose your country/region, and then click **Contact HP** for information on calling for technical support.

---

### Ink expiration near

**Cause:** The ink in the indicated ink cartridge(s) is near expiration.

**Solution:** One or more of the ink cartridges are near their expiration date.

Each ink cartridge has an expiration date. The purpose of expiration is to protect the printing system and to ensure ink quality. When you receive an ink cartridge(s) are expired message, remove and replace the expired ink cartridge, and then close the message. You can also continue printing without replacing the ink cartridge, by following the instructions on the HP All-in-One or the ink cartridge expiration message on your computer screen. HP recommends replacing the expired ink cartridges. HP cannot guarantee the quality or reliability of expired ink cartridges. Device service or repairs required as a result of using expired ink will not be covered under warranty.

For more information, see:

[“Replace the ink cartridges” on page 159](#)

---

### Ink supply error

**Cause:** The indicated ink cartridge was removed during maintenance.

**Solution:** Replace the indicated ink cartridge with the previous ink cartridge during the maintenance procedure. After the maintenance procedure is complete, you can insert the new ink cartridge.

For more information, see:

[“Replace the ink cartridges” on page 159](#)

---

### Non-HP ink

**Cause:** The HP All-in-One detected non-HP ink.

**Solution:** Replace the indicated ink cartridge(s).

HP recommends that you use genuine HP ink cartridges. Genuine HP ink cartridges are designed and tested with HP printers to help you easily produce great results, time after time.

---

 **NOTE:** HP cannot guarantee the quality or reliability of non-HP ink. Printer service or repairs required as a result of printer failure or damage attributable to the use of non-HP ink will not be covered under warranty.

---

If you believe you purchased genuine HP ink cartridge(s), go to:

[www.hp.com/go/anticounterfeit](http://www.hp.com/go/anticounterfeit)

For more information, see:

[“Replace the ink cartridges” on page 159](#)

---

### Original HP ink depleted

**Cause:** The original HP ink in the indicated ink cartridge(s) has been depleted.

**Solution:** Replace the indicated ink cartridge(s) or press **OK** on the control panel to continue.

HP recommends that you use genuine HP ink cartridges. Genuine HP ink cartridges are designed and tested with HP printers to help you easily produce great results, time after time.

---

 **NOTE:** HP cannot guarantee the quality or reliability of non-HP ink. Printer service or repairs required as a result of printer failure or damage attributable to the use of non-HP ink will not be covered under warranty.

---

For more information, see:

[“Replace the ink cartridges” on page 159](#)

---

### Print head assembly is stalled

**Cause:** The print head assembly is blocked.

**Solution:** Remove any objects that are blocking the print head assembly.

#### To clear the print head assembly

1. Open the ink cartridge door by lifting from the front center of the device, until the door locks into place.

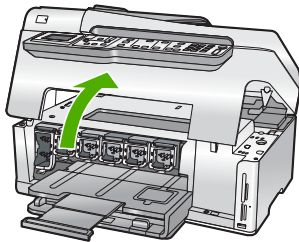

2. Remove any objects that are blocking the print head assembly, including any packing materials.
  3. Turn the HP All-in-One off, then turn it on again.
  4. Close the ink cartridge door.
- 

### Print head failure

**Cause:** The print head assembly or the ink delivery system has failed and the HP All-in-One can no longer print.

**Solution:** Contact HP support. Go to:

[www.hp.com/support](http://www.hp.com/support)

If prompted, choose your country/region, and then click **Contact HP** for information on calling for technical support.

---

## Alignment failed

**Cause:** An incorrect type of paper is loaded in the input tray.

**Solution:** If you have color or photo paper loaded in the input tray when you align the printer, the alignment might fail. Load unused plain white letter or A4 paper into the input tray, and then try the alignment again. If the alignment fails again, you might have a defective sensor.

Contact HP support. Go to:

[www.hp.com/support](http://www.hp.com/support)

If prompted, choose your country/region, and then click **Contact HP** for information on calling for technical support.

---

**Cause:** The print head assembly or sensor is defective.

**Solution:** Contact HP support. Go to:

[www.hp.com/support](http://www.hp.com/support)

If prompted, choose your country/region, and then click **Contact HP** for information on calling for technical support.

---

## Replace ink cartridges soon

**Cause:** The indicated ink cartridge is estimated to be low on ink and might need to be replaced soon.

**Solution:** You might be able to continue printing for a short period of time with ink remaining in the print head assembly. Replace the indicated ink cartridge(s) or follow the prompts on the display or computer screen to continue.

For more information, see:

[“Replace the ink cartridges” on page 159](#)

---

## Scheduled maintenance

**Cause:** The HP All-in-One performs a periodic maintenance procedure to ensure excellent print quality.

**Solution:** Load unused plain white letter or A4 paper in the input tray. Then follow the prompts on the display or computer screen to continue.

---

## Wrong ink cartridge(s) installed

**Cause:** The wrong ink cartridge(s) are installed.

**Solution:** The first time you set up and use the HP All-in-One, make sure to install the ink cartridges that were shipped with your device. The ink in these ink cartridges is specially formulated to mix with the ink in the print head assembly.

To resolve this error, replace the affected ink cartridge(s) with the ink cartridges that were shipped with the HP All-in-One.

For more information, see:

[“Replace the ink cartridges” on page 159](#)

---

### **Ink cartridge is missing, incorrectly installed, or not intended for your device**

**Cause:** One or more ink cartridges are missing.

**Solution:** Remove and reinsert the ink cartridges and verify that they are fully inserted and locked in place.

---

**Cause:** One or more of the ink cartridges are not installed or are installed incorrectly.

**Solution:** Remove and reinsert the ink cartridges and verify that they are fully inserted and locked in place. If the problem persists, clean the copper-colored contacts of the ink cartridges.

For more information, see:

- [“Replace the ink cartridges” on page 159](#)
  - [“Clean the ink cartridge contacts” on page 163](#)
- 

**Cause:** The ink cartridge is defective or not intended for use in this device.

**Solution:** Replace the indicated ink cartridge(s) immediately so that you can resume printing. If there are no ink cartridges missing from the HP All-in-One, the ink cartridge contacts might need to be cleaned.

If there are no ink cartridges missing from the HP All-in-One, and you still receive this message after cleaning the ink cartridge contacts, you might have a damaged ink cartridge. Contact HP support. Go to:

[www.hp.com/support](http://www.hp.com/support)

If prompted, choose your country/region, and then click **Contact HP** for information on calling for technical support.

For more information, see:

[“Replace the ink cartridges” on page 159](#)

---

**Cause:** The wrong ink cartridge(s) are installed.

**Solution:** The first time you set up and use the HP All-in-One, make sure to install the ink cartridges that were shipped with your device. The ink in these ink cartridges is specially formulated to mix with the ink in the print head assembly.

To resolve this error, replace the affected ink cartridge(s) with the ink cartridges that were shipped with the HP All-in-One.

For more information, see:

[“Replace the ink cartridges” on page 159](#)

---

# 16 HP warranty and support

Hewlett-Packard provides Internet and phone support for the HP All-in-One.

This section contains the following topics:

- [Warranty](#)
- [Ink cartridge warranty information](#)
- [Support process](#)
- [Before you call HP support](#)
- [HP support by phone](#)
- [Additional warranty options](#)
- [HP Quick Exchange Service \(Japan\)](#)
- [Call HP Korea customer support](#)
- [Prepare the HP All-in-One for shipment](#)
- [Pack the HP All-in-One](#)

## Warranty

For more information about the warranty, see the printed documentation that came with the HP All-in-One.

## Ink cartridge warranty information

The HP cartridge warranty is applicable when the product is used in its designated HP printing device. This warranty does not cover HP ink products that have been refilled, remanufactured, refurbished, misused, or tampered with.

During the warranty period the product is covered as long as the HP ink is not depleted and the end of warranty date has not been reached. The end of warranty date, in YYYY/MM/DD format, may be found on the product as indicated:

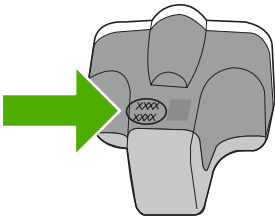

For a copy of the HP Limited Warranty Statement, see the printed documentation that came with the HP All-in-One.



## Support process

### If you have a problem, follow these steps:

1. Check the documentation that came with the HP All-in-One.
2. Visit the HP online support Web site at [www.hp.com/support](http://www.hp.com/support). HP online support is available to all HP customers. It is the fastest source for up-to-date device information and expert assistance and includes the following features:
  - Fast access to qualified online support specialists
  - Software and driver updates for the HP All-in-One
  - Valuable HP All-in-One and troubleshooting information for common problems
  - Proactive device updates, support alerts, and HP newsgrams that are available when you register the HP All-in-One
3. Call HP support. Support options and availability vary by device, country/region, and language.

## Before you call HP support

Software programs from other companies might be included with the HP All-in-One. If you experience problems with any of those programs, you will receive the best technical assistance by calling the experts at that company.



**NOTE:** This information does not apply to customers in Japan. For information on service options in Japan, see [“HP Quick Exchange Service \(Japan\)” on page 282](#).

### If you need to contact HP support, do the following before you call:

1. Make sure that:
  - a. The HP All-in-One is plugged in and turned on.
  - b. The specified ink cartridges are installed correctly.
  - c. The recommended paper is properly loaded in the input tray.
2. Reset the HP All-in-One:
  - a. Turn off the HP All-in-One by pressing the **On** button.
  - b. Unplug the power cord from the back of the HP All-in-One.
  - c. Plug the power cord back into the HP All-in-One.
  - d. Turn on the HP All-in-One by pressing the **On** button.
3. To find support and warranty information, go to the HP Web site at [www.hp.com/support](http://www.hp.com/support). If prompted, choose your country/region, and then click **Contact HP** for information on calling for technical support.  
Check the HP Web site for updated information or troubleshooting tips for the HP All-in-One .
4. If you are still experiencing problems and need to speak with an HP support representative, do the following:
  - a. Have the specific name of the HP All-in-One, as it appears on the control panel, available.
  - b. Print a self-test report.
  - c. Make a color copy to have available as a sample printout.
  - d. Be prepared to describe your problem in detail.
  - e. Have your serial number ready.  
You can view the serial number by looking at the sticker on the rear side of the HP All-in-One. The serial number is the 10-character code in the upper left corner of the sticker.
5. Call HP support. Be near the HP All-in-One when you call.

### Related topics

[“Print a self-test report” on page 149](#)

## HP support by phone

For a list of support phone numbers, see the printed documentation that came with the device.

This section contains the following topics:

- [Phone support period](#)
- [Placing a call](#)
- [After the phone support period](#)

### Phone support period

One year of phone support is available in North America, Asia Pacific, and Latin America (including Mexico). To determine the duration of phone support in Europe, the Middle East, and Africa, go to [www.hp.com/support](http://www.hp.com/support). Standard phone company charges apply.

### Placing a call

Call HP support while you are in front of the computer and the HP All-in-One. Be prepared to provide the following information:

- Model number (located on the label on the front of the HP All-in-One)
- Serial number (located on the back or bottom of the HP All-in-One)
- Messages that appear when the situation occurs
- Answers to these questions:
  - Has this situation happened before?
  - Can you re-create it?
  - Did you add any new hardware or software to your computer at about the time that this situation began?
  - Did anything else occur prior to this situation (such as a thunderstorm, HP All-in-One was moved, etc.)?

### After the phone support period

After the phone support period, help is available from HP at an additional cost. Help may also be available at the HP online support Web site: [www.hp.com/support](http://www.hp.com/support). Contact your HP dealer or call the support phone number for your country/region to learn more about support options.

## Additional warranty options

Extended service plans are available for the HP All-in-One at additional costs. Go to [www.hp.com/support](http://www.hp.com/support), select your country/region and language, then explore the services and warranty area for information about the extended service plans.

## HP Quick Exchange Service (Japan)

インク カートリッジに問題がある場合は以下に記載されている電話番号に連絡してください。インク カートリッジが故障している、または欠陥があると判断された場合、HP Quick Exchange Service がこのインク カートリッジを正常品と交換し、故障したインクカートリッジを回収します。保障期間中は、修理代と配送料は無料です。また、お住まいの地域にもよりますが、プリンタを次の日までに交換することも可能です。

電話番号： 0570-000511 (自動応答)  
03-3335-9800 (自動応答システムが使用できない場合)

サポート時間： 平日の午前 9:00 から午後 5:00 まで  
土日の午前 10:00 から午後 5:00 まで  
祝祭日および 1 月 1 日から 3 日は除きます。

サービスの条件:

- サポートの提供は、カスタマケアセンターを通してのみ行われます。
- カスタマケアセンターがプリンタの不具合と判断した場合に、サービスを受けることができます。

ご注意：ユーザの扱いが不適切であったために故障した場合は、保障期間中であっても修理は有料となります。詳細については保証書を参照してください。

その他の制限:

- 運搬の時間はお住まいの地域によって異なります。詳しくは、カスタマケアセンターに連絡してご確認ください。
- 出荷配送は、当社指定の配送業者が行います。
- 配送は交通事情などの諸事情によって、遅れる場合があります。
- このサービスは、将来予告なしに変更することがあります。

For instructions on how to pack your device for exchange, see [“Pack the HP All-in-One”](#) on page 284.

## Call HP Korea customer support

HP 한국 고객 지원 문의

- 고객 지원 센터 대표 전화  
1588-3003
- 제품가격 및 구입처 정보 문의 전화  
080-703-0700
- 전화 상담 가능 시간:  
평 일 09:00~18:00  
토요일 09:00~13:00  
(일요일, 공휴일 제외)

## Prepare the HP All-in-One for shipment

If, after contacting HP support or returning to the point of purchase, you are requested to send the HP All-in-One in for service, make sure you remove and keep the following items before returning your device:

- The control panel faceplate
- The power cord, USB cable, and any other cable connected to the HP All-in-One

---

**△ CAUTION:** The replacement HP All-in-One will not be shipped with a power cord. Store the power cord in a safe place until the replacement HP All-in-One arrives.

---

- Any paper loaded in the input tray
- Remove any originals you might have loaded in the HP All-in-One

This section contains the following topics:

- [Secure the ink system](#)
- [Remove the control panel faceplate](#)

### Secure the ink system

Contact HP support for information about how you should secure the ink system to prevent ink from leaking in the HP All-in-One during shipment. They might instruct you to replace the ink cartridges with replacement ink cartridges.

If you receive a replacement HP All-in-One, refer to the instructions included in the box for information about how to secure the ink system. The replacement HP All-in-One might come with ink cartridges that you can use to install in your device to prevent the ink system from leaking during shipment.

---

 **NOTE:** This information does not apply to customers in Japan. For information on service options in Japan, see "[HP Quick Exchange Service \(Japan\)](#)" on page 282.

---

#### Related topics

["Replace the ink cartridges" on page 159](#)

### Remove the control panel faceplate

Remove the control panel faceplate before returning the HP All-in-One for repair.

---

 **NOTE:** This information does not apply to customers in Japan. For information on service options in Japan, see "[HP Quick Exchange Service \(Japan\)](#)" on page 282.

**△ CAUTION:** The HP All-in-One must be unplugged before following these steps.

---

#### To remove the control panel faceplate

1. Press the **On** button to turn off the HP All-in-One.
2. Unplug the power cord, and then disconnect it from the HP All-in-One. Do not return the power cord with the HP All-in-One.
3. Remove the control panel faceplate as follows:
  - a. Place your hands on each side of the control panel faceplate.
  - b. Use your fingertips to pry the control panel faceplate off.

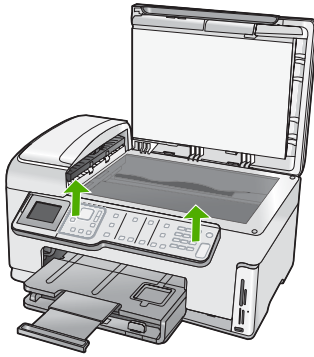

4. Retain the control panel faceplate. Do not return the control panel faceplate with the HP All-in-One.

⚠ **CAUTION:** The replacement HP All-in-One might not come with a control panel faceplate. Store your control panel faceplate in a safe place, and when the replacement HP All-in-One arrives, reattach your control panel faceplate. You must attach your control panel faceplate to use the control panel functions on the replacement HP All-in-One.

📄 **NOTE:** See the Setup Guide that came with the HP All-in-One for instructions on how to attach your control panel faceplate. The replacement HP All-in-One might come with instructions for setting up your device.

## Pack the HP All-in-One

Complete the following steps after you have prepared the HP All-in-One for shipment.

### To pack the HP All-in-One

1. If available, pack the HP All-in-One for shipment by using the original packing materials or the packaging materials that came with your exchange device.

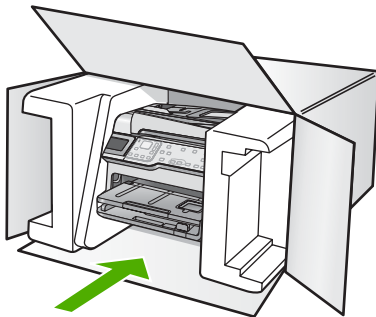

If you do not have the original packaging materials, please use other adequate packaging materials. Shipping damage caused by improper packaging and/or improper transportation is not covered under the warranty.

2. Place the return shipping label on the outside of the box.
3. Include the following items in the box:
  - A complete description of symptoms for service personnel (samples of print quality problems are helpful).
  - A copy of the sales slip or other proof of purchase to establish the warranty coverage period.
  - Your name, address, and a phone number where you can be reached during the day.



# 17 Technical information

The technical specifications and international regulatory information for the HP All-in-One are provided in this section.

For additional specifications, see the printed documentation that came with the HP All-in-One.

This section contains the following topics:

- [Specifications](#)
- [Environmental product stewardship program](#)
- [Regulatory notices](#)
- [Regulatory wireless statements](#)
- [Declaration of conformity \(European Economic Area\)](#)
- [HP Photosmart C7200 All-in-One series declaration of conformity](#)

## Specifications

Technical specifications for the HP All-in-One are provided in this section. For additional specifications, see the printed documentation that came with the HP All-in-One.

### System requirements

Software and system requirements are located in the Readme file.

For information about future operating system releases and support, visit the HP online support Web site at [www.hp.com/support](http://www.hp.com/support).

### Paper specifications

Type	Paper weight	Input tray*	Output tray†	Photo tray*
Plain paper	20 to 24 lb. (75 to 90 gsm)	Up to 100 (20 lb. paper)	50 (20 lb. paper)	n/a
Legal paper	20 to 24 lb. (75 to 90 gsm)	Up to 100 (20 lb. paper)	50 (20 lb. paper)	n/a
Cards	110 lb. index max (200 gsm)	Up to 40	25	Up to 20
Envelopes	20 to 24 lb. (75 to 90 gsm)	Up to 10	10	n/a
Transparency film	N/A	Up to 30	15 or fewer	n/a
Labels	N/A	Up to 30	25	n/a
4 x 6 inch (10 x 15 cm) Photo paper	145 lb. (236 gsm)	Up to 30	25	Up to 20
8.5 x 11 inch (216 x 279 mm) Photo paper	N/A	Up to 30	10	n/a

\* Maximum capacity.

† Output tray capacity is affected by the type of paper and the amount of ink you are using. HP recommends emptying the output tray frequently.

\* Maximum capacity.

 **NOTE:** For a complete list of supported media sizes, see the printer driver.



**Print specifications**

- Up to 1200 x 1200 rendered dpi black when printing from a computer
- Up to 4800 x 1200 optimized dpi color when printing from a computer and 1200-input dpi
- Print speeds vary according to the complexity of the document
- Panorama-size printing
- Method: drop-on-demand thermal inkjet
- Language: PCL3 GUI
- Duty cycle: Up to 3000 printed pages per month

**Copy specifications**

- Copy resolution up to 4800 x 4800
- Digital image processing
- Up to 99 copies from original (varies by model)
- Zoom to 400%, fit to page (varies by model)
- Copy speeds vary according to the complexity of the document

**Scan specifications**

- Image editor included
- Integrated OCR software automatically converts scanned text to editable text (if installed)
- Twain-compliant interface
- Resolution: up to 4800 x 9600 dpi optical (varies by model); 19200 dpi enhanced (software)
- Color: 48-bit color, 8-bit grayscale (256 levels of gray)
- Maximum scan size from glass: 21.6 x 29.7 cm (8.5 x 11.7 inches)

**Fax specifications**

- Walk-up black-and-white and color fax capability.
- Up to 110 speed dials (varies by model).
- Up to 120-page memory (varies by model, based on ITU-T Test Image #1 at standard resolution). More complicated pages or higher resolution takes longer and uses more memory.
- Manual fax send and receive.
- Automatic busy redial up to five times (varies by model).
- Automatic no-answer redial one time (varies by model).
- Confirmation and activity reports.
- CCITT/ITU Group 3 fax with Error Correction Mode.
- 33.6 Kbps transmission.
- 3 seconds per page speed at 33.6 Kbps (based on ITU-T Test Image #1 at standard resolution). More complicated pages or higher resolution take longer and use more memory.
- Ring detect with automatic fax/answering machine switching.

	Photo (dpi)	Very Fine (dpi)	Fine (dpi)	Standard (dpi)
Black	200 x 200 (8-bit grayscale)	300 x 300	200 x 200	200 x 100
Color	200 x 200	200 x 200	200 x 200	200 x 200

**Print resolution**

To find out about the printer resolution, see the printer software. For more information, see [“View the print resolution”](#) on page 85.

**Ink cartridge yield**

Visit [www.hp.com/pageyield](http://www.hp.com/pageyield) for more information on estimated cartridge yields.

### Acoustic information

If you have Internet access, you can get acoustic information from the HP Web site. Go to: [www.hp.com/support](http://www.hp.com/support).

## Duplexer paper specifications

Table 17-1 Media weight

Type	Size	Weight
Paper	Letter: 8.5 x 11 inches Executive: 7.25 x 10.5 inches A4: 210 x 297 mm A5: 148 x 210 mm	60 to 90 g/m <sup>2</sup> (16 to 24 lb.)
Brochure paper	Letter: 8.5 x 11 inches A4: 210 x 297 mm	Up to 180 g/m <sup>2</sup> (48 lb. bond)
Cards and photos	4 x 6 inches 5 x 8 inches 10 x 15 cm A6: 105 x 148.5 mm Hagaki: 100 x 148 mm	Up to 200 g/m <sup>2</sup> (110 lb. index)

### Alignment skew

.006 mm/mm on plain paper (2nd side)

### Media type

- Plain paper
- Inkjet paper
- Brochure paper
- Index cards, post cards, Hagaki



**NOTE:** Media type availability varies by country/region.

## Environmental product stewardship program

Hewlett-Packard is committed to providing quality products in an environmentally sound manner. Design for recycling has been incorporated into this product. The number of materials has been kept to a minimum while ensuring proper functionality and reliability. Dissimilar materials have been designed to separate easily. Fasteners and other connections are easy to locate, access, and remove using common tools. High priority parts have been designed to access quickly for efficient disassembly and repair.

For more information, visit HP's Commitment to the Environment Web site at:

[www.hp.com/hpinfo/globalcitizenship/environment/index.html](http://www.hp.com/hpinfo/globalcitizenship/environment/index.html)

This section contains the following topics:

- [Paper use](#)
- [Plastics](#)
- [Material safety data sheets](#)
- [Recycling program](#)
- [HP inkjet supplies recycling program](#)

- [Energy consumption](#)
- [Special handling of materials](#)
- [Attention California users](#)
- [NDL battery disposal](#)
- [Taiwan battery statement](#)
- [Disposal of Waste Equipment by Users in Private Households in the European Union](#)

## Paper use

This product is suited for the use of recycled paper according to DIN 19309 and EN 12281:2002.

## Plastics

Plastic parts over 25 grams are marked according to international standards that enhance the ability to identify plastics for recycling purposes at the end of product life.

## Material safety data sheets

Material safety data sheets (MSDS) can be obtained from the HP Web site at:

[www.hp.com/go/msds](http://www.hp.com/go/msds)

## Recycling program

HP offers an increasing number of product return and recycling programs in many countries/regions, and partners with some of the largest electronic recycling centers throughout the world. HP conserves resources by reselling some of its most popular products. For more information regarding recycling of HP products, please visit:

[www.hp.com/hpinfo/globalcitizenship/environment/recycle/](http://www.hp.com/hpinfo/globalcitizenship/environment/recycle/)

## HP inkjet supplies recycling program

HP is committed to protecting the environment. The HP Inkjet Supplies Recycling Program is available in many countries/regions, and lets you recycle used print cartridges and ink cartridges free of charge. For more information, go to the following Web site:

[www.hp.com/hpinfo/globalcitizenship/environment/recycle/](http://www.hp.com/hpinfo/globalcitizenship/environment/recycle/)

## Energy consumption

This product is designed to reduce power consumption and save natural resources without compromising product performance. It has been designed to reduce total energy consumption both during operation and when the device is not active. Specific information on power consumption may be found in the printed documentation that came with the HP All-in-One.

## Special handling of materials

This HP product contains a lithium-manganese dioxide battery located on the main printed circuit assembly that may require special handling at end-of-life.

## Attention California users

The battery supplied with this product may contain perchlorate material. Special handling may apply. For more information, go to the following Web site:

[www.dtsc.ca.gov/hazardouswaste/perchlorate](http://www.dtsc.ca.gov/hazardouswaste/perchlorate)

## NDL battery disposal



Dit HP Product bevat een lithium-manganees-dioxide batterij. Deze bevindt zich op de hoofdprintplaat. Wanneer deze batterij leeg is, moet deze volgens de geldende regels worden afgevoerd.

# Taiwan battery statement

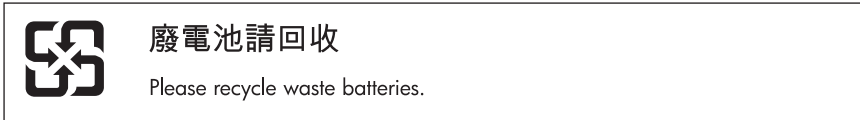

## Disposal of Waste Equipment by Users in Private Households in the European Union

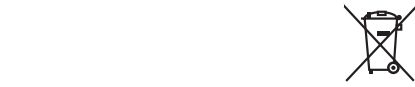

**Disposal of Waste Equipment by Users in Private Households in the European Union**  
 This symbol on the product or on its packaging indicates that this product must not be disposed of with your other household waste. Instead, it is your responsibility to dispose of your waste equipment by handing it over to a designated collection point for the recycling of waste electrical and electronic equipment. The separate collection and recycling of your waste equipment at the time of disposal will help to conserve natural resources and ensure that it is recycled in a manner that protects human health and the environment. For more information about where you can drop off your waste equipment for recycling, please contact your local city office, your household waste disposal service or the shop where you purchased the product.

**Évacuation des équipements usagés par les utilisateurs dans les foyers privés ou sein de l'Union européenne**  
 La présence de ce symbole sur le produit ou sur son emballage indique que vous ne pouvez pas vous débarrasser de ce produit de la même façon que des déchets courants. Au contraire, vous êtes responsable de l'évacuation de ces équipements usagés et, à cet effet, vous êtes tenu de les remettre à un point de collecte agréé pour le recyclage des équipements électriques et électroniques usagés. Le tri, l'évacuation et le recyclage adéquats de ces équipements usagés permettent de préserver les ressources naturelles et de s'assurer que ces équipements sont recyclés dans le respect de la santé humaine et de l'environnement. Pour plus d'informations sur les lieux de collecte des équipements usagés, veuillez contacter votre mairie, votre service de traitement des déchets ménagers ou le magasin où vous avez acheté le produit.

**Entsorgung von Elektrogeräten durch Benutzer in privaten Haushalten in der EU**  
 Dieses Symbol auf dem Produkt oder dessen Verpackung weist auf an, dass das Produkt nicht mit dem Restmüll entsorgt werden darf. Es obliegt daher Ihrer Verantwortung, das Gerät an einer entsprechenden Stelle für die Entsorgung oder Wiederverwertung von Elektrogeräten aller Art abzugeben (z.B. ein Wertstoffhof). Die separate Sammlung und das Recycling Ihrer alten Elektrogeräte zum Zeitpunkt Ihrer Entsorgung trägt zum Schutz der Umwelt bei und gewährleistet, dass sie auf eine Art und Weise recycelt werden, die keine Gefährdung für die Gesundheit des Menschen und der Umwelt darstellt. Weitere Informationen darüber, wo Sie alte Elektrogeräte zum Recyceln abgeben können, erhalten Sie bei den örtlichen Behörden, Abfallbehörden oder dort, wo Sie das Gerät erworben haben.

**Smaltimento di apparecchiature da rottamare da parte di privati nell'Unione Europea**  
 Questo simbolo è presente sul prodotto o sulla confezione indicato che il prodotto non deve essere smaltito assieme agli altri rifiuti domestici. Gli utenti devono provvedere allo smaltimento delle apparecchiature da rottamare portandole al luogo di raccolta indicato per il riciclaggio delle apparecchiature elettriche ed elettroniche. La raccolta e il riciclaggio separati delle apparecchiature da rottamare in fase di smaltimento favoriscono la conservazione delle risorse naturali e garantiscono che tali apparecchiature vengano rottamate nel rispetto dell'ambiente e della tutela della salute. Per ulteriori informazioni sui punti di raccolta delle apparecchiature da rottamare, contattare il proprio comune di residenza, il servizio di smaltimento dei rifiuti locale o il negozio presso il quale è stato acquistato il prodotto.

**Eliminación de residuos de aparatos eléctricos y electrónicos por parte de usuarios domésticos en la Unión Europea**  
 Este símbolo en el producto o en el empaque indica que no se puede desechos el producto junto con los residuos domésticos. Por el contrario, si debe eliminar este tipo de residuo, es responsabilidad del usuario entregarlo en un punto de recogida designado de reciclado de aparatos eléctricos y electrónicos. El reciclaje y la recogida por separado de estos residuos en el momento de la eliminación ayudan a preservar recursos naturales y a garantizar que el reciclaje proteja la salud y el medio ambiente. Si desea información adicional sobre los lugares donde puede dejar estos residuos para su reciclado, póngase en contacto con las autoridades locales de su ciudad, con el servicio de gestión de residuos domésticos o con la tienda donde adquirió el producto.

**Likvidace vyzvolizhoľa zařízení užívaná v domácnosti v zemi EU**  
 Tato značka na produktu nebo na jeho obalu označuje, že tento produkt nemí být likvidován společně s ostatními domácími odpady. Odpovědné za to, že vyzvolizhoľa zařízené bude předána k likvidaci do stanovených místních míst určení k recyklaci vyzvolizhoľa elektrických a elektronických zařízení. Likvidace vyzvolizhoľa zařízené samostatným sběrem a recyklací napomáhá zachovávat přírodní zdroje a zajišťuje, že recyklace proběhne v způsobem chránícím lidské zdraví a životní prostředí. Další informace o tom, kam můžete vyzvolizhoľa zařízené předat k recyklaci, můžete získat od úřadů místní samosprávy, od společnosti provádějící svoz a likvidaci domovního odpadu nebo v obchodě, kde jste produkt zakoupili.

**Bortskaffelse af affaldsudstyr for brugere i private husholdninger i EU**  
 Dette symbol på produktet eller på dets emballage indikerer, at produktet ikke må bortskaffes sammen med andet husholdningsaffald. I stedet er det dit ansvar at bortskaffe affaldsudstyr ved at aflevere det på det dertil benævnte indsamlingssted med henblik på genbrug af elektrisk og elektronisk affaldsudstyr. Den separate indsamling og genbrug af dit affaldsudstyr på tidspunktet for bortskaffelse er med til at bevare naturlige ressourcer og sikre, at genbrug finder sted på en måde, der beskytter menneskers helbreds samt miljøet. Hvis du vil vide mere om, hvor du kan aflevere dit affaldsudstyr til genbrug, kan du kontakte kommunen, det lokale renoveringsvæsen eller den forretning, hvor du købte produktet.

**Aforos van atdanginate aparaturu door gebruikers in particuliere huishoudens in de Europese Unie**  
 Dit symbool op het product of de verpakking geeft aan dat dit product niet mag worden afgevoerd met het huishoudelijk afval. Het is uw verantwoordelijkheid uw afgedankte apparaat of de leerveren op een aangewezen inzamelpunt voor de verwerking van afgedankte elektrische en elektronische apparatuur. De gescheiden inzameling en verwerking van uw afgedankte apparatuur draagt bij tot de behouding van natuurlijke hulpbronnen en zorgt ervoor dat de verwerking veilig is voor de menselijke gezondheid. Voor meer informatie over waar u uw afgedankte apparatuur kunt inleveren voor recycling kunt u contact opnemen met het gemeentebestuur in uw woonplaats, de reiningsdienst of de winkel waar u het product hebt aangekocht.

**Erromagidmatitas kasutusest kõrvaldatavate seadmete käitlemine Euroopa Liidus**  
 Kui tootel või toote pakendil on see sümbol, ei tohi seda loodet viivalt ära visata üldmüüja hulla. Teie kohus on viia tarbetuks muutunud seadme selliselt ettenähtud elektrilise ja elektronikaasenduste ühisestamiskohale. Ühisestamisteenuste eraldi kogumise ja käitlemise abil säilitatakse loodusvarad ning tagatakse, et käitlemine toimub inimeste tervisele ja keskkonnale ohult. Lisateave selle kohta, kuhu saate ühisestamiskohta seadme käitlemiseks viia, saate küsida kohalikul omavalitsusel, olemasolevatelt viiteasukohtadelt, jäätisehoidla või tootete järelevalvetoimelt.

**Hävitettävien laitteiden käsittely kotitalouksissa Euroopan unionissa**  
 Tämä lauseke on sen pakkausmerkkinä, että tuotteen ei saa hävittää tavallisen kotijätteen mukana. Käyttäjien velvollisuus on huolehtia siitä, että hävitettävät laitteet toimittetaan erikseen ja elektronikkajätteenarvonnassa keräyskeskukseen. Hävitettävien laitteiden keräys ja kierrätys säästää luonnonvaroja. Niin toimimalla varmistetaan myös, että kierrätys tapahtuu turvallisella, joka suojaa ihmisten tervyyttä ja ympäristöä. Saat tarvittavissa laitteissa (jätteen keräilyasemista paikallisilla toimistoilla, jätehuolto- tai tuotteen jällemyyntitoimistosta).

**Ανάφωρη όργανων συσκευών στην Ευρωπαϊκή Ένωση**  
 Το παρόν σύμβολο στον εξοπλισμό ή τη συσκευασία του υποδηλώνει ότι το προϊόν αυτό δεν πρέπει να πεταχτεί με άλλα οικιακά απόβλητα. Αντίθετα, ευθύνη σας είναι να αποφύγετε τις άσκοπες συσκευές σε μια καθορισμένη περιοχή συλλογής απορριμμάτων για την ανακύκλωση όργανων ηλεκτρικών και ηλεκτρονικών εξοπλισμού. Η χωριστή συλλογή και ανακύκλωση των απορριμμάτων θα συμβάλει στη διατήρηση των φυσικών πόρων και στη διασφάλιση ότι η ανακύκλωση γίνεται με τον πιο ασφαλές, υγιεινό και προστατευτικό για την ανθρώπινη και το περιβάλλον. Για περισσότερες πληροφορίες σχετικά με το πού μπορείτε να αποφύγετε τις άσκοπες συσκευές για ανακύκλωση, επικοινωνήστε με τις κατά τόπους αρχές, όπως ή με τα καταστήματα από τα οποία αγοράσαστε το προϊόν.

**A hulladékok nyakozakozése a magánháztartásokban az Európai Unióban**  
 Ez a szimbólum, amely a terméken vagy annak csomagolásán van feltüntetve, azt jelzi, hogy a termék nem kezelhető egyúttal az egyéb háztartási hulladékkal. Az Ön feladata, hogy a későbbi hulladékgyűjtéssel elvitassa olyan kijelölt gyűjtőhelyre, amely az elektronikus hulladékoké és az elektronikus berendezések újrahasznosítását szolgálja. A hulladékgyűjtés elkülönült gyűjtése és újrahasznosítása hozzájárul a természeti erőforrások megőrzéséhez, egyúttal azt is biztosítja, hogy a hulladék újrahasznosítása az egészségre és a környezetre nem ártalmas módon történjen. Ha többet szeretne tudni arról, hogy lehetőségek vannak a hulladékgyűjtésre, forduljon a helyi önkormányzatához, a háztartási hulladék begyűjtésével foglalkozó vállalatához vagy a termék forgalmazójához.

**Lietaisju atbrīvošana no nedrēģinām līerēm Eiropas Savienības privātos mājāsniecībās**  
 Šis simbols uz ierīci vai tā iepakojuma norāda, ka šis līeris nedrēģināt kopā ar pārējiem mājāsniecības atkritumiem. Jūs esat atbildīgs par atbrīvošanu no nedrēģinām līerēm, ko nododot norādītā savākšanas vieta, lai tika veikta nedrēģinām elektriskā un elektroniskā aprīkojuma atbrīvošana. Speciāla nedrēģinām līerēm savākšana un nedrēģinām pārstrāde palīdz tautai dabas resursus un nodrošina tautā atbrīvošanu pārstrādi, kas sargā cilvēku veselību un apkārtni tīru. Lai iegūtu papildu informāciju par to, kur atbrīvojat pārstrādi var nosaukt nedrēģinām līerēm, lūdz, sazināties ar vietējo valdību, mājasapvalks vai atbrīvošanas dienestu, olemasolevat viiteasukohtas, jātisehoidla, kurā iegādājāties šo ierīci.

**Eiropas Savienozos varotāju ir privātu namu ūķu atliekamos izņemšanas ierīmes**  
 Šis simbols attēlo produktu ar vai pakotnes norādi, ka produkts negali būti iemesta kopā ar citiem mājāsniecības atkritumiem. Jūs privāto iemēti savus atliekamos izņemotāju un atliekamos elektriskos un elektroniskos ierīmes jānodrošina savlaicīgi un pērtīdri. Jūs esat atbildīgs par atbrīvošanu no nedrēģinām līerēm savākšanu un nedrēģinām pārstrādi. Atbrīvošana un atbrīvošana palīdz tautai dabas resursus un nodrošina tautā atbrīvošanu pārstrādi, kas sargā cilvēku veselību un apkārtni tīru. Lai iegūtu papildu informāciju par to, kur atbrīvojat pārstrādi var nosaukt nedrēģinām līerēm, lūdz, sazināties ar vietējo valdību, mājasapvalks vai atbrīvošanas dienestu, olemasolevat viiteasukohtas, jātisehoidla, kurā iegādājāties šo ierīci.

**Uytlyozhā zuytēgo sprēzhu prēzhu utykovnikōv domovykh v Unii Eyopekiskoy**  
 Simbol na umieszczeniu na produkcie lub opakowaniu oznacza, że tego produktu nie należy wyrzucać razem z innymi odpadami domowymi. Użytkownik jest odpowiedzialny za dostarczenie zużytego sprzętu do wyznaczonego punktu gromadzenia zużytych urządzeń elektrycznych i elektronicznych. Gromadzenie odpadów i recykling tego typu urządzeń przyczynia się do oszczędności naturalnych zasobów i zapewnia, że recykling odbywa się w sposób chroniący zdrowie i środowisko. Dodatkowe informacje na temat sposobów wydzielenia zużytych urządzeń można uzyskać u odpowiednich władz lokalnych, w przedsiębiorstwach zajmujących się usuwaniem odpadów lub w miejscu zakupu produktu.

**Descarte de equipamentos por usuários em residências da União Europeia**  
 Este símbolo no produto ou no embalagem indica que o produto não pode ser descartado junto com o lixo doméstico. No entanto, é sua responsabilidade levar os equipamentos a serem descartados a um ponto de coleta designado para o reciclagem de equipamentos eletro-eletrônicos. A coleta separada e o reciclagem dos equipamentos no momento do descarte ajudam na conservação dos recursos naturais e garantem que os equipamentos sejam reciclados de forma a proteger a saúde das pessoas e o meio ambiente. Para obter mais informações sobre onde descartar equipamentos para reciclagem, entre em contato com o escritório local de seu cidade, o serviço de limpeza pública de sua cidade ou o loja em que adquiriu o produto.

**Postup používateľov v krajínach Európskej únie pri vyhazovaní zariadenia v domácom používaní do odpadu**  
 Tento symbol na produkte alebo na jeho obale označuje, že tento produkt nemôže byť vyhazovaný spoločne s ostatnými domácimi odpadmi. Odpovedné za to, že zariadenie bude predané k likvidácii do stanovených miestnych miest určených k recyklácii vyzvolizhoľa elektrických a elektronických zariadení. Likvidácia vyzvolizhoľa zariadení samostatným sběrom a recykláci napomáhá zachovávat přírodní zdroje a zajišťuje, že recyklace proběhne v způsobem chránícím lidské zdraví a životní prostředí. Další informace o tom, kam můžete vyzvolizhoľa zariadené předat k recyklaci, můžete získat od úřadů místní samosprávy, od společnosti provádějící svoz a likvidaci domovního odpadu nebo v obchodě, kde jste produkt kúpili.

**Kassering av förbrukningsmaterial, för hem- och privatvårdare i EU**  
 Produkter eller produktförpackningar med den här symbolen får inte kasseras med vanligt hushållsavfall. I stället får du ansvar för att produkten lämnas till en behörig återvinningstjänst för hantering av el- och elektroniska produkter. Genom att lämna dessa produkter till denna tjänst hjälper du till att bevara våra gemensamma naturresurser. Dessutom skyddas både människor och miljön när produkter återvinns på rätt sätt. Kommunal myndigheter, sophanteringsförsteg eller butikler där varan köptes kan ge mer information om var du lämnar kasserade produkter för återvinning.

Technical information

## Regulatory notices

The HP All-in-One meets product requirements from regulatory agencies in your country/region.

This section contains the following topics:

- [Regulatory model identification number](#)
- [FCC statement](#)
- [Notice to users of the U.S. telephone network: FCC requirements](#)
- [Note à l'attention des utilisateurs du réseau téléphonique canadien/notice to users of the Canadian telephone network](#)
- [Notice to users in the European Economic Area](#)
- [Notice to users of the German telephone network](#)
- [Australia wired fax statement](#)
- [Notice to users in Korea](#)
- [VCCI \(Class B\) compliance statement for users in Japan](#)
- [Notice to users in Japan about power cord](#)
- [Geräuschemission](#)

### Regulatory model identification number

For regulatory identification purposes, your product is assigned a Regulatory Model Number. The Regulatory Model Number for your product is SDGOB-0713. This regulatory number should not be confused with the marketing name (HP Photosmart C7200 All-in-One series, etc.) or product numbers (CC567A, etc.).

## FCC statement

### FCC statement

The United States Federal Communications Commission (in 47 CFR 15.105) has specified that the following notice be brought to the attention of users of this product.

This equipment has been tested and found to comply with the limits for a Class B digital device, pursuant to Part 15 of the FCC Rules. These limits are designed to provide reasonable protection against harmful interference in a residential installation. This equipment generates, uses and can radiate radio frequency energy and, if not installed and used in accordance with the instructions, may cause harmful interference to radio communications. However, there is no guarantee that interference will not occur in a particular installation. If this equipment does cause harmful interference to radio or television reception, which can be determined by turning the equipment off and on, the user is encouraged to try to correct the interference by one or more of the following measures:

- Reorient the receiving antenna.
- Increase the separation between the equipment and the receiver.
- Connect the equipment into an outlet on a circuit different from that to which the receiver is connected.
- Consult the dealer or an experienced radio/TV technician for help.

For further information, contact:

Manager of Corporate Product Regulations  
Hewlett-Packard Company  
3000 Hanover Street  
Palo Alto, Ca 94304  
(650) 857-1501

Modifications (part 15.21)

The FCC requires the user to be notified that any changes or modifications made to this device that are not expressly approved by HP may void the user's authority to operate the equipment.

This device complies with Part 15 of the FCC Rules. Operation is subject to the following two conditions: (1) this device may not cause harmful interference, and (2) this device must accept any interference received, including interference that may cause undesired operation.

## Notice to users of the U.S. telephone network: FCC requirements

### Notice to users of the U.S. telephone network: FCC requirements

This equipment complies with FCC rules, Part 68. On this equipment is a label that contains, among other information, the FCC Registration Number and Ringer Equivalent Number (REN) for this equipment. If requested, provide this information to your telephone company.

An FCC compliant telephone cord and modular plug is provided with this equipment. This equipment is designed to be connected to the telephone network or premises wiring using a compatible modular jack which is Part 68 compliant. This equipment connects to the telephone network through the following standard network interface jack: USOC RJ-11C.

The REN is useful to determine the quantity of devices you may connect to your telephone line and still have all of those devices ring when your number is called. Too many devices on one line might result in failure to ring in response to an incoming call. In most, but not all, areas the sum of the RENs of all devices should not exceed five (5). To be certain of the number of devices you may connect to your line, as determined by the REN, you should call your local telephone company to determine the maximum REN for your calling area.

If this equipment causes harm to the telephone network, your telephone company might discontinue your service temporarily. If possible, they will notify you in advance. If advance notice is not practical, you will be notified as soon as possible. You will also be advised of your right to file a complaint with the FCC. Your telephone company might make changes in its facilities, equipment, operations, or procedures that could affect the proper operation of your equipment. If they do, you will be given advance notice so you will have the opportunity to maintain uninterrupted service. If you experience trouble with this equipment, please contact the manufacturer, or look elsewhere in this manual, for warranty or repair information. Your telephone company might ask you to disconnect this equipment from the network until the problem has been corrected or until you are sure that the equipment is not malfunctioning.

This equipment may not be used on coin service provided by the telephone company.

Connection to party lines is subject to state tariffs. Contact your state public utility commission, public service commission, or corporation commission for more information.

This equipment includes automatic dialing capability. When programming and/or making test calls to emergency numbers:

- Remain on the line and explain to the dispatcher the reason for the call.
- Perform such activities in the off-peak hours, such as early morning or late evening.



**Note** The FCC hearing aid compatibility rules for telephones are not applicable to this equipment.

The Telephone Consumer Protection Act of 1991 makes it unlawful for any person to use a computer or other electronic device, including fax machines, to send any message unless such message clearly contains in a margin at the top or bottom of each transmitted page or on the first page of transmission, the date and time it is sent and an identification of the business, other entity, or other individual sending the message and the telephone number of the sending machine or such business, other entity, or individual. (The telephone number provided might not be a 900 number or any other number for which charges exceed local or long-distance transmission charges.) In order to program this information into your fax machine, you should complete the steps described in the software.

## Note à l'attention des utilisateurs du réseau téléphonique canadien/notice to users of the Canadian telephone network

### Note à l'attention des utilisateurs du réseau téléphonique canadien/Notice to users of the Canadian telephone network

Cet appareil est conforme aux spécifications techniques des équipements terminaux d'Industrie Canada. Le numéro d'enregistrement atteste de la conformité de l'appareil. L'abréviation IC qui précède le numéro d'enregistrement indique que l'enregistrement a été effectué dans le cadre d'une Déclaration de conformité stipulant que les spécifications techniques d'Industrie Canada ont été respectées. Néanmoins, cette abréviation ne signifie en aucun cas que l'appareil a été validé par Industrie Canada.

Pour leur propre sécurité, les utilisateurs doivent s'assurer que les prises électriques reliées à la terre de la source d'alimentation, des lignes téléphoniques et du circuit métallique d'alimentation en eau sont, le cas échéant, branchées les unes aux autres. Cette précaution est particulièrement importante dans les zones rurales.



**Remarque** Le numéro REN (Ringer Equivalence Number) attribué à chaque appareil terminal fournit une indication sur le nombre maximal de terminaux qui peuvent être connectés à une interface téléphonique. La terminaison d'une interface peut se composer de n'importe quelle combinaison d'appareils, à condition que le total des numéros REN ne dépasse pas 5.

Basé sur les résultats de tests FCC Partie 68, le numéro REN de ce produit est 0.0B.

This equipment meets the applicable Industry Canada Terminal Equipment Technical Specifications. This is confirmed by the registration number. The abbreviation IC before the registration number signifies that registration was performed based on a Declaration of Conformity indicating that Industry Canada technical specifications were met. It does not imply that Industry Canada approved the equipment.

Users should ensure for their own protection that the electrical ground connections of the power utility, telephone lines and internal metallic water pipe system, if present, are connected together. This precaution might be particularly important in rural areas.



**Note** The REN (Ringer Equivalence Number) assigned to each terminal device provides an indication of the maximum number of terminals allowed to be connected to a telephone interface. The termination on an interface might consist of any combination of devices subject only to the requirement that the sum of the Ringer Equivalence Numbers of all the devices does not exceed 5.

The REN for this product is 0.0B, based on FCC Part 68 test results.



## Notice to users in the European Economic Area

### Notice to users in the European Economic Area



This product is designed to be connected to the analog Switched Telecommunication Networks (PSTN) of the European Economic Area (EEA) countries/regions.

Network compatibility depends on customer selected settings, which must be reset to use the equipment on a telephone network in a country/region other than where the product was purchased. Contact the vendor or Hewlett-Packard Company if additional product support is necessary.

This equipment has been certified by the manufacturer in accordance with Directive 1999/5/EC (annex II) for Pan-European single-terminal connection to the public switched telephone network (PSTN). However, due to differences between the individual PSTNs provided in different countries, the approval does not, of itself, give an unconditional assurance of successful operation on every PSTN network termination point.

In the event of problems, you should contact your equipment supplier in the first instance.

This equipment is designed for DTMF tone dialing and loop disconnect dialing. In the unlikely event of problems with loop disconnect dialing, it is recommended to use this equipment only with the DTMF tone dial setting.

## Notice to users of the German telephone network

### Hinweis für Benutzer des deutschen Telefonnetzwerks

Dieses HP-Fax ist nur für den Anschluss eines analogen Public Switched Telephone Network (PSTN) gedacht. Schließen Sie den TAE N-Telefonstecker, der im Lieferumfang des HP All-in-One enthalten ist, an die Wandsteckdose (TAE 6) Code N an. Dieses HP-Fax kann als einzelnes Gerät und/oder in Verbindung (mit seriellem Anschluss) mit anderen zugelassenen Endgeräten verwendet werden.

## Australia wired fax statement

In Australia, the HP device must be connected to Telecommunication Network through a line cord which meets the requirements of the Technical Standard AS/ACIF S008.

## Notice to users in Korea

사용자 안내문(B급 기기)

이 기기는 비업무용으로 전자파 적합 등록을 받은 기기로서, 주거지역에서는 물론 모든 지역에서 사용할 수 있습니다.

## VCCI (Class B) compliance statement for users in Japan

この装置は、情報処理装置等電波障害自主規制協議会（VCCI）の基準に基づくクラスB情報技術装置です。この装置は、家庭環境で使用することを目的としていますが、この装置がラジオやテレビジョン受信機に近接して使用されると受信障害を引き起こすことがあります。

取り扱い説明書に従って正しい取り扱いをして下さい。

## Notice to users in Japan about power cord

製品には、同梱された電源コードをお使い下さい。  
同梱された電源コードは、他の製品では使用出来ません。

## Geräuschemission

### Geräuschemission

LpA < 70 dB am Arbeitsplatz im Normalbetrieb nach DIN 45635 T. 19

## Regulatory wireless statements

This section contains the following regulatory information pertaining to wireless products:

- [Wireless: Exposure to radio frequency radiation](#)
- [Wireless: Notice to users in Brazil](#)
- [Wireless: Notice to users in Canada](#)
- [European Union Regulatory Notice](#)
- [Wireless: Notice to users in Taiwan](#)

## Wireless: Exposure to radio frequency radiation

### Exposure to radio frequency radiation



**Caution** The radiated output power of this device is far below the FCC radio frequency exposure limits. Nevertheless, the device shall be used in such a manner that the potential for human contact during normal operation is minimized. This product and any attached external antenna, if supported, shall be placed in such a manner to minimize the potential for human contact during normal operation. In order to avoid the possibility of exceeding the FCC radio frequency exposure limits, human proximity to the antenna shall not be less than 20 cm (8 inches) during normal operation.

## Wireless: Notice to users in Brazil

### Aviso aos usuários no Brasil

Este equipamento opera em caráter secundário, isto é, não tem direito à proteção contra interferência prejudicial, mesmo de estações do mesmo tipo, e não pode causar interferência a sistemas operando em caráter primário. (Res.ANATEL 282/2001).

## Wireless: Notice to users in Canada

### Notice to users in Canada/Note à l'attention des utilisateurs canadiens

**For Indoor Use.** This digital apparatus does not exceed the Class B limits for radio noise emissions from the digital apparatus set out in the Radio Interference Regulations of the Canadian Department of Communications. The internal wireless radio complies with RSS 210 and RSS GEN of Industry Canada.

**Utiliser à l'intérieur.** Le présent appareil numérique n'émet pas de bruit radioélectrique dépassant les limites applicables aux appareils numériques de la classe B prescrites dans le Règlement sur le brouillage radioélectrique édicté par le ministère des Communications du Canada. Le composant RF interne est conforme à la norme RSS-210 and RSS GEN d'Industrie Canada.

## European Union Regulatory Notice

### European Union Regulatory Notice

Products bearing the CE marking comply with the following EU Directives:

- Low Voltage Directive 73/23/EEC
- EMC Directive 2004/108/EC

CE compliance of this product is valid only if powered with the correct CE-marked AC adapter provided by HP.

If this product has telecommunications functionality, it also complies with the essential requirements of the following EU Directive:

- R&TTE Directive 1999/5/EC

Compliance with these directives implies conformity to harmonized European standards (European Norms) that are listed in the EU Declaration of Conformity issued by HP for this product or product family. This compliance is indicated by the following conformity marking placed on the product.



The wireless telecommunications functionality of this product may be used in the following EU and EFTA countries:

Austria, Belgium, Cyprus, Czech Republic, Denmark, Estonia, Finland, France, Germany, Greece, Hungary, Iceland, Ireland, Italy, Latvia, Liechtenstein, Lithuania, Luxembourg, Malta, Netherlands, Norway, Poland, Portugal, Slovak Republic, Slovenia, Spain, Sweden, Switzerland, and United Kingdom.

### Products with 2.4-GHz wireless LAN devices

#### France

For 2.4 GHz Wireless LAN operation of this product certain restrictions apply: This product may be used indoor for the entire 2400-2483.5 MHz frequency band (channels 1-13). For outdoor use, only 2400-2454 MHz frequency band (channels 1-9) may be used. For the latest requirements, see <http://www.art-telecom.fr>.

#### Italy

License required for use. Verify with your dealer or directly with the General Direction for Frequency Planning and Management (Direzione Generale Pianificazione e Gestione Frequenze).

## 低功率電波輻射性電機管理辦法

### 第十二條

經型式認證合格之低功率射頻電機，非經許可，公司、商號或使用者均不得擅自變更頻率、加大功率或變更設計之特性及功能。

### 第十四條

低功率射頻電機之使用不得影響飛航安全及干擾合法通信；經發現有干擾現象時，應立即停用，並改善至無干擾時方得繼續使用。

前項合法通信，指依電信法規定作業之無線電通信。低功率射頻電機須忍受合法通信或工業、科學及醫藥用電波輻射性電機設備之干擾。

## Declaration of conformity (European Economic Area)

The Declaration of Conformity in this document complies with ISO/IEC 17050-1 and EN 17050-1. It identifies the product, manufacturer's name and address, and applicable specifications recognized in the European community.

# HP Photosmart C7200 All-in-One series declaration of conformity



## DECLARATION OF CONFORMITY

according to ISO/IEC 17050-1 and EN 17050-1

**Supplier's Name:** Hewlett-Packard Company DoC#: SDGOB-0713-rel.2.0  
**Supplier's Address:** 16399 West Bernardo Drive  
 San Diego, CA 92127-1899, USA

### declares, that the product

**Product Name and Model:** HP Photosmart C7200 Series (CC564A)  
**Regulatory Model Number:<sup>1)</sup>** SDGOB-0713  
**Product Options:** ALL  
**Radio Module:** RSVLD-0608  
**Power Adapter:** 0957-2230

### conforms to the following Product Specifications and Regulations:

**EMC:** CISPR 22:1997+A1:2000+A2:2002 / EN 55022:1998+A1:2000+A2:2003 Class B  
 CISPR 24:1997+A1:2001+A2:2002 / EN 55024:1998+A1:2001+A2:2003 Class B  
 EN 301 489-1 V1.4.1:2002 / EN 301 489-17 V1.2.1:2002  
 IEC 61000-3-2:2000+A1:2000+A2:2005 / EN 61000-3-2:2000+A2:2005  
 IEC 61000-3-3:1994+A1:2001 / EN 61000-3-3:1995+A1:2001  
 FCC Title 47 CFR, Part 15 Class B / ICES-003, Issue 4  
 GB9254:1998, GB17625.1:2003

**SAFETY:** IEC 60950-1:2001 / EN 60950-1:2001  
 IEC 60825-1 Ed. 1.2:2001 / EN 60825-1+A2+A1:2002 (LED)  
 GB4943:2001

**TELECOM:** TBR21:1998, FCC Title 47 CFR Part 68, TIA/EIA/968:2001

**RADIO:** EN 300 328 V1.6.1:2004-11

**HEALTH:** EU: 1999/519/EC

This Device complies with Part 15 of the FCC Rules. Operation is subject to the following two Conditions: (1) this device may not cause harmful interference, and (2) this device must accept any interference received, including interference that may cause undesired operation.

The product herewith complies with the requirements of the EMC Directive 2004/108/EC, the Low Voltage Directive 2006/95/EC and the R&TTE Directive 1999/5/EC and carries the CE-Marking accordingly.

### Additional Information:

1. This product is assigned a Regulatory Model Number which stays with the regulatory aspects of the design. The Regulatory Model Number is the main product identifier in the regulatory documentation and test reports, this number should not be confused with the marketing name or the product numbers.

San Diego, CA, USA  
 17 January, 2007

### Local contact for regulatory topics only:

EMEA: Hewlett-Packard GmbH, HQ-TRE, Herrenberger Strasse 140, 71034 Böblingen, Germany  
 U.S.: Hewlett-Packard, 3000 Hanover St., Palo Alto 94304, U.S.A. 650-857-1501

# Index

## Symbols/Numerics

- 10 x 15 cm photo paper
  - copy 122
  - load 78
  - specifications 287
- 2 pages on 1, print 95
- 4 pages on 1, print 95
- 4 x 6 inch (10 x 15 cm)
  - borderless photos
    - print 90
- 4 x 6 inch photo paper
  - copy 122
- 4 x 6 inch photo paper, load 78
- 802.11 wireless, configuration page 56
- 802.3 wired, configuration page 54

## A

- A4 paper, load 76
- access point connection 39
- access point HW address 59
- ad hoc network 43
- addresses, print 97
- admin password 54
- advanced network settings 50
- after the support period 281
- align printer 161
- answer ring pattern 63
- answering machine
  - fax tones recorded 236
  - set up with fax 242
- authentication type 58
- automatic document feeder
  - clean 173, 191
  - feeding problems,
    - troubleshoot 173, 191
  - load original 71
- automatic fax reduction 145

## B

- backup fax reception 141
- base station. *See* access point connection
- baud rate 30
- best copy quality 124

- blank
  - copy 219
  - scan 213
- blank pages
  - fax 230
- block numbers 145
- blocked print head 178
- Bluetooth
  - accessibility 33
  - connect to the HP All-in-One 32
  - passkey authentication 33
  - print from a computer 34
  - security settings 33
- Bluetooth, configuration page 59
- booklet printing 93
- borderless copies 126
- borderless photos
  - copy has borders 218
  - crop is wrong 218
  - print 90
- brightness, change in print 87
- broadcast a fax 136
- Browsing photos 27
- buttons, control panel 13

## C

- calling card, fax using 133, 134
- cancel
  - button 14
  - copy 129
  - fax 148
  - fax forwarding 143
  - print job 99
  - scan 119
  - scheduled fax 136
- cartridges. *See* ink cartridges
- CAT-5 Ethernet cable 38
- channel, wireless
  - communication 57
- choose paper 73
- clean
  - automatic document feeder 173, 191
  - exterior 157
  - glass 155
  - ink cartridge contacts 163
  - lid backing 157
  - print head 162
- color
  - dull 195
  - fax 136
  - smear 193
- color graphics display
  - copy preview 121
  - crop original 128
  - shift margin 128
- color tone, change in print 87
- communication mode 57
- communication problems
  - test failed 269
  - two-way communication
    - lost 271
- computer modem, set up with fax 242
- computer-to-computer network 43
- config source (802.3 wired) 55
- configuration page
  - 802.11 wireless 56
  - 802.3 wired 54
  - Bluetooth 59
  - general information 54
- configuration source 56
- confirmation reports, fax 150
- connect
  - wired network (Ethernet) 37
  - wireless, with access
    - point 39
  - wireless, without access
    - point 39
- connection
  - wireless 32
- connection problems
  - device not found 270
  - fax 219, 225, 226, 231, 235
  - HP All-in-One does not turn on 175
- connection types supported
  - Bluetooth adapter 32

- Ethernet 31
    - printer sharing 36
  - contrast, fax 138
  - control panel
    - buttons 13
    - enter text and symbols 18
    - features 13
    - overview 12
  - copy
    - blank 219
    - borderless has borders 218
    - borderless photo 126
    - cancel 129
    - crop 128
    - crop is wrong 218
    - default settings 125
    - enlarge 127
    - fit to page fails 217
    - make a copy 121
    - margin shift 128
    - menu 16
    - missing information 216
    - number of copies 122
    - paper size 122
    - paper types,
      - recommended 123
    - photos, enhance 129
    - preview 121
    - quality 124
    - reduce 127
    - size, custom 127
    - smear 193
    - specifications 288
    - speed 124
    - text, enhance 129
    - too dark 216
    - too light 216
    - troubleshooting 215
  - correct port test, fax 252
  - country/region, set 25
  - credit card, fax using 133, 134
  - crop
    - borderless copy is
      - wrong 218
    - fails 264
  - crop an original 128
  - crop photos 109
  - customer support
    - HP Quick Exchange Service (Japan) 282
    - Korea 282
    - warranty 279, 281
- D**
- damaged, ink cartridge 273
  - dark copy 216
  - darken
    - copies 125
    - faxes 138
  - date 26
  - declaration of conformity
    - European Economic Area 299
    - United States 300
  - default gateway 56
  - default gateway (802.3 wired) 55
  - default printer, set as 84
  - default settings
    - fax 139
    - restore 28
  - default settings, restore 49
  - delete
    - faxes from memory 143
    - speed dial entries 67
  - device
    - no response 201
    - not found 270
  - device address (Bluetooth) 59
  - device name (Bluetooth) 59
  - dial tone test, fax 254
  - direction pad 13
  - disconnected error 265
  - Display
    - icons 14
  - display
    - change language 177
    - change measurements 177
    - sleep state 15
  - distinctive ringing 63
  - DNS server 57
  - DNS server (802.3 wired) 55
  - documents
    - edit scanned 118
    - scan 115
  - double-sided prints 93
- E**
- ECM. See error correction mode
  - edit
    - scan preview 118
  - edit scanned images 118
  - Embedded Web Server
    - access using web browser 52
    - password settings 54
    - setup wizard 53
  - encryption
    - settings 58
    - WEP key 44
  - enter text and symbols 18
  - envelopes
    - load 80
    - specifications 287
  - environment
    - Environmental product stewardship program 289
  - error correction mode 139
  - error messages
    - memory cards 264
    - out of paper 268
    - reading or writing file 262
  - error reports, fax 151
  - European Union
    - Directive 2002/95/EC 290
    - recycling information 291
  - EWS. See Embedded Web Server
- F**
- factory defaults, restore 28
  - faded 199
  - fast copy quality 125
  - fax
    - answer call 140
    - answer mode 62
    - answer ring pattern 63
    - answering machine, set
      - up 242
    - auto answer 14, 62
    - backup fax reception 141
    - block numbers 145
    - broadcast 136
    - button 14
    - cancel 148
    - computer modem, set
      - up 242
    - contrast 138
    - coupler 242
    - darken or lighten 138
    - default settings 139
    - delete from memory 143
    - distinctive ringing 63
    - enter text and symbols 18
    - error correction mode 139
    - forward fax calls 143
    - header 64
    - Internet, over 147, 256

- IP phone, using 147, 256
- lighten or darken 138
- log 151
- menu 17
- monitor dialing 134
- not answering 238
- paper checking 144
- paper size 144
- paper width incorrect 269
- parallel splitter 242
- pause 18
- photos 136
- poll to receive 143
- poor quality printouts 190, 191, 199
- problems receiving 199, 238
- pulse or tone dial 29
- receive 140
- redial 29
- reduction 145
- reprint 142
- resolution 137
- rings to answer 62
- schedule 135
- send 131
- set up 61
- settings 29, 62, 137
- specifications 288
- speed 30
- speed dial 65, 132
- test setup 63
- tone or pulse dial 29
- troubleshoot 219
- voice mail, set up 242
- volume 26
- fax problems
  - blank pages 199, 230
  - fax tones recorded 236
  - not printing 240
  - pages missing 228, 240
  - poor print quality 191, 199, 228
  - receiving 219, 230, 231, 235
  - sending 219, 225, 226, 230
  - slow transmission 230
  - smeared ink 190
  - static on phone line 248
  - text cut off 229, 241
  - troubleshoot 219
- FCC statement 293
- file
  - invalid name 263
  - supported formats 263
  - unreadable 262
  - unsupported formats 262
- firmware revision mismatch 259
- firmware version 54
- fit to page 127
- fit to page fails 217
- FoIP 147, 256
- forward
  - fax calls 143
- G**
  - gateway, default setting 55, 56
  - general information, configuration page 54
  - glass
    - clean 155
    - load original 72
  - greeting cards, load 81
  - group speed dial entries 66
- H**
  - Hagaki, load 79
  - hardware address 56
  - hardware address (802.3 wired) 54
  - hardware test, fax 250
  - header, fax 64
  - help
    - menu 17
  - hostname 54, 60
  - HP Instant Share
    - send a scan 119
  - HP Photosmart
    - send images 107
- I**
  - images
    - crop 109
    - edit scanned 118
    - rotate 110
    - scan 115
    - send a scan 119
    - zoom 109
  - improper shutdown 271
  - index cards, load 79
  - individual speed dial entries 65
  - infrastructure mode 39
  - ink
    - drying time 268
    - empty 274
    - low 207
    - replace soon 277
    - sprays inside device 198
    - sprays inside HP All-in-One 207
  - ink cartridge
    - failure 274
  - ink cartridges
    - check ink levels 157
    - clean contacts 163
    - damaged 273
    - empty 274
    - error message 278
    - error messages 271
    - expired 274
    - HP ink depleted 275
    - incorrect 272, 273, 277, 278
    - missing 273
    - non-HP ink 275
    - order 167
    - replace 159
    - replace soon 277
    - supply error 275
    - tips 170
    - troubleshoot 177
  - ink levels
    - icons 14
  - ink levels, check 157
  - ink supplies
    - purchase 167
  - ink, removing ink from skin and clothing 164
  - interface card 40
  - Internet, fax using 147, 256
  - invalid file name 263
  - IP
    - address 54, 55, 56
    - phone 147, 256
    - settings 51
  - iron-on transfers 96
- J**
  - jams, paper 82, 178
  - junk fax number 145
- K**
  - keypad 14, 18



- L**
- labels
  - load 81
  - specifications 287
- landscape orientation 86
- language, set 25
- left arrow 13
- legal paper
  - copy 122
  - load 76
  - specifications 287
- letter paper
  - copy 123
  - load 76
  - specifications 287
- lid backing, clean 157
- light
  - copy 216
- lighten
  - copies 125
  - faxes 138
- line condition test, fax 254
- link
  - configuration 55
  - speed 50
- load
  - 10 x 15 cm photo paper 78
  - 4 x 6 inch photo paper 78
  - A4 paper 76
  - envelopes 80
  - full-size paper 76
  - greeting cards 81
  - Hagaki 79
  - index cards 79
  - iron-on transfers 81
  - labels 81
  - legal paper 76
  - letter paper 76
  - original 71
  - postcards 79
  - transparencies 81
- log, fax 151
- M**
- MAC address 54, 56
- maintenance
  - align printer 161
  - check ink levels 157
  - clean exterior 157
  - clean glass 155
  - clean lid backing 157
  - clean print head 162
  - replace ink cartridges 159
- restore factory defaults 28
- self-test report 149
- set FEMP mode 165
- make a copy 121
- manual
  - receive, fax 140
  - send, fax 133, 134
- margins
  - incorrect 205
  - text or graphic cut off 206
- maximum resolution quality 124
- mDNS service name 54
- media. *See* paper
- Media Access Control (MAC)
  - address 54, 56
- memory
  - delete faxes 143
  - reprint faxes 142
  - save faxes 141
- memory cards
  - digital camera cannot
    - read 208
  - e-mail photos 107
  - error message 264
  - file unreadable 262
  - HP All-in-One cannot
    - read 208
  - inaccessible 211
  - insert 108
  - photos missing 262
  - read or write error 211
  - save files to computer 108
  - scan to 117
  - share photos 107
  - slots 101
- menus
  - copy 16
  - fax 17
  - help 17
  - scan to 17
  - setup 17
- missing
  - information from copy 216
  - ink cartridge 273
  - text from scan 214
- modem. *See* computer modem
- monitor dialing 134
- N**
- network
  - advanced settings 50
  - connection type 54
  - interface card 40
  - name 57
  - restore settings 49
  - security 44
  - status 54
  - upgrade 47
- network configuration page 53
- no scan options error 265
- normal copy quality 125
- number of copies 122
- O**
- OK button 13
- on button 14
- order
  - ink cartridges 167
  - ink supplies 167
- out of paper 268
- overheads, print 96
- P**
- page order 95
- paper
  - choose 73
  - feed fails 198
  - incompatible types 75
  - jam 259, 268
  - jams 82, 171, 178
  - load 76
  - misfeed 268
  - out of 268
  - recommended copy
    - types 123
  - recommended sizes for
    - printing 84
  - recommended types 73, 74
  - size incorrect 269
  - size, set for fax 144
  - specifications 287
  - tips 171
  - type incorrect 269
  - type, check before
    - faxing 144
    - width incorrect 269
- paper checking, fax 144
- paper size
  - copy setting 122
- paper type 85
- passkey (Bluetooth) 59
- password, Embedded Web Server 54
- PC modem. *See* computer modem

- peer-to-peer network 43
  - phone
    - receive fax 140
    - send fax 133
  - phone cord
    - check 252
    - connection, failure 252
  - phone line, answer ring
    - pattern 63
  - phone numbers, support 280
  - phone support 281
  - phone support period
    - period for support 281
  - photo
    - photosmart express
      - menu 16
  - Photo browsing 27
  - photo paper
    - copy 123
    - load 78
    - specifications 287
  - photos
    - add a frame 109
    - add color effect 109
    - adjust brightness 109
    - crop 109
    - e-mail 107
    - edit scanned 118
    - fax 136
    - flip horizontal 109
    - ink sprays 207
    - missing 262
    - print borderless 90
    - print on photo paper 91
    - remove red-eye 109
    - rotate 110
    - send using HP
      - Photosmart 107
    - share 107
    - zoom 109
  - Photosmart Express 13
  - poll to receive fax 143
  - poor fax printout quality 190, 191, 199
  - poor print quality
    - fax 228
  - portrait orientation 86
  - postcards
    - load 79
  - posters 98
  - preview copy 121
  - preview image, edit 118
  - preview print job 87
  - print
    - 2 or 4 pages on 1 95
    - addresses 97
    - blank printout 207
    - booklet 93
    - borderless fails 201
    - borderless photos 90
    - both sides of page 93
    - cancel job 99
    - CD/DVD labels 92
    - correct order 95
    - distorted printout 193
    - envelopes 97
    - envelopes print
      - incorrectly 200
    - faded 195
    - fax reports 152
    - faxes 142
    - from computer 83
    - from software application 83
    - iron-on transfers 96
    - labels 97
    - margins incorrect 205, 206
    - meaningless characters 203
    - multiple pages on one
      - sheet 95
    - nothing happens 203
    - on photo paper 91
    - posters 98
    - preview 87
    - print options 84, 88
    - quality, troubleshoot 190, 191, 194, 196, 199, 228
    - reverse images 96
    - reversed page order 205
    - self-test report 149
    - special print jobs 90
    - specifications 288
    - transparencies 96
    - troubleshooting 200
    - vertical streaks 197
    - Web pages 98
  - print cartridges
    - low ink 207
  - print head
    - clean 162
    - failure 276
    - stalled 276
  - print head, blocked 178
  - print quality 86
  - print settings
    - brightness 87
    - color tone 87
    - layout 86
    - orientation 86
    - paper size 84
    - paper type 85
    - print quality 189
    - quality 86
    - reduce/enlarge 87
    - resizing options 87
    - resolution 86
    - saturation 87
    - speed 86
  - printer found screen,
    - Windows 47
  - printer sharing
    - Mac 36
    - Windows 36
  - printer, align 161
  - Printing Shortcuts tab 88
  - problems
    - copy 215
    - error messages 258
    - print 200
    - scan 212
  - pulse dial 29
- Q**
- quality
    - print 86
  - quality, copy 124
- R**
- radio, turn off 50
  - receive fax
    - auto answer mode 62
    - automatically 140
    - block numbers 145
    - forward calls 143
    - manually 140
    - polling 143
    - rings to answer 62
  - recycle
    - ink cartridges 290
  - red-eye, remove 109
  - redial fax 29
  - reduce fax 145
  - reduce/enlarge copies
    - custom size 127
    - resize to fit letter or A4 127
  - regulatory notices
    - Canadian statement 295
    - China 290

- declaration of conformity (European Economic Area) 299
    - declaration of conformity (U.S.) 300
    - Directive 2002/95/EC 290
    - FCC part 68
      - requirements 294
    - FCC statement 293
    - geräuschemission 297
    - notice to users in Japan (power cord) 297
    - notice to users in Japan (VCCI) 297
    - notice to users in Korea 296
    - notice to users of the German telephone network 296
    - notice to users of the U.S. telephone network 294
    - regulatory model
      - identification number 292
    - telecom notice to users in the European Economic Area 296
    - wireless statements 297
  - reinstall software 181
  - removing ink from skin and clothing 164
  - replace ink cartridges 159
  - reports
    - caller ID 152
    - confirmation, fax 150
    - error, fax 151
    - fax log 151
    - junk fax numbers 152
    - last fax transaction 152
    - log, fax 151
    - self-test 149
    - speed dial list 152
  - reprint faxes in memory 142
  - resolution
    - print 86
  - resolution, fax 137
  - restore factory settings 28
  - restore network defaults 49
  - right arrow 13
  - rings to answer 62
  - RJ-45 plug 38, 60
  - rotate photos 110
  - router 38
- S**
- saturation, change in print 87
  - save
    - faxes in memory 141
    - photos to computer 108
    - scanned image 117
  - scan
    - blank 213
    - button 14
    - cancel 119
    - crop incorrect 214
    - documents 115, 116
    - edit image 118
    - fails 213, 260
    - features 115
    - from control panel 117
    - halts 213
    - no scan options error 265
    - page layout incorrect 214
    - photos 115, 116
    - preview image, edit 118
    - save to computer 117
    - save to memory card 117
    - save to storage device 117
    - scan specifications 288
    - send using HP Photosmart Share 119
    - share images 119
    - stop 119
    - text appears as dotted lines 214
    - text format incorrect 214
    - text incorrect 214
    - to memory card 117
    - troubleshooting 212
  - scan glass
    - clean 155
    - load original 72
  - scan to
    - menu 17
  - schedule fax 135
  - security
    - Bluetooth 59
    - Bluetooth adapter 33
    - network, WEP key 40, 44, 45, 46, 57, 58
    - troubleshoot 44
  - self-test report 149
  - send fax
    - basic fax 131
    - broadcast 136
    - calling card, using 133, 134
    - color fax 136
    - credit card, using 133, 134
    - manually 133, 134
    - memory, from 135
    - monitor dialing 134
    - multiple recipients 136
    - schedule 135
    - speed dial 132
  - send images using HP Photosmart Share
    - scanned image 119
  - set
    - print options 84, 88
  - settings
    - country/region 25
    - date and time 26
    - fax 29, 62, 137
    - language 25
    - network 48
    - restore defaults 49
  - setup
    - answering machine 242
    - button 14
    - computer modem 242
    - distinctive ringing 63
    - fax 61
    - menu 17
    - test fax 63
    - voice mail 242
  - sharing 47
  - shift left margin 128
  - ship your device 283
  - signal strength 57
  - sleep state 15
  - Smart Key 40
  - smear ink, fax 190
  - software application, print from 83
  - software installation
    - reinstall 181
    - troubleshoot 179
    - uninstall 181
  - sound, adjust volume 26
  - speed
    - copy 124
    - print 86
  - speed dial
    - create entries 65
    - delete entries 67
    - edit entries 66
    - group entries 66
    - individual entries 65
    - print list 67, 152

## Index

- send fax 131, 132
- set up 65
- SSID
  - troubleshoot 186
  - wireless setting 57
- start copy black 14
- start copy color 14
- start fax
  - black 14
  - color 14
- status, network 54
- stop
  - copy 129
  - fax 148
  - print job 99
  - scan 119
- Store Demo 28
- subnet mask 55, 56
- subscriber identification
  - code 64
- support
  - contact 280
- support process 280
- symbols, enter 18
- system requirements 287

**T**

- T-shirt transfers. *See* iron-on transfers
- technical information
  - copy specifications 288
  - fax specifications 288
  - paper specifications 287
  - print specifications 288
  - scan specifications 288
  - system requirements 287
- telephone
  - receive fax 140
  - send fax 133
- telephone line, answer ring
  - pattern 63
- telephone numbers, support 280
- telephone wall jack test, fax 251
- test
  - dial tone 254
  - fax hardware 250
  - fax line condition 254
  - fax port 252
  - fax setup 63
  - phone cord 252
  - telephone wall jack 251

- text
  - cut off 206, 229, 241
  - dotted lines on scan 214
  - enhance on copies 129
  - incorrect format on
    - scan 214
  - incorrect or missing on
    - scan 214
  - jagged 192
  - meaningless characters 203
  - not filled in 191
  - smooth fonts 192
- text, enter 18
- time 26
- Tips Slideshow 28
- tone dial 29
- total packets
  - received 59
  - transmitted 59
- total packets received (802.3 wired) 56
- total packets transmitted (802.3 wired) 55
- transparencies
  - copy 123
  - load 81
  - specifications 287
- troubleshoot
  - blocked print head 178
  - fax problems 190, 191, 199, 219, 225, 226, 228, 229, 230, 231, 235, 236, 238, 240, 241, 248, 256
  - hardware installation 174
  - incorrect
    - measurements 177
  - jams, paper 82, 178
  - language, display 177
  - low signal 187
  - network connection 187
  - network setup 183
  - Passphrase, invalid 188
  - printer alignment 177
  - printer not found 189
  - software installation 179
  - USB cable 176
  - WEP key 188
  - wireless setup wizard 183, 186
- troubleshooting
  - cannot find the file or item 212

- communication
  - problems 169
- copy 215
- error messages 258
- file system 208
- filename appears as gibberish 211
- others on network can
  - access my memory card 212
- print 200
- Printer not Found 185
- scan 212
- unable to discover
  - device 183
- two-sided prints 93

**U**

- uninstall software 181
- upgrade to network 47
- URL 54
- USB cable
  - communication lost 271
- USB cable installation 176

**V**

- visibility (Bluetooth) 59
- voice mail, set up with fax 242
- volume, adjust 26

**W**

- wall jack test, fax 251
- warranty 279, 281
- Web pages, print 98
- WEP key, setup 44
- wireless
  - radio, turn off 50
  - setup wizard,
    - troubleshoot 183, 186
    - status 57
  - wireless regulatory notices
    - exposure to wireless frequency radiation 297
    - notice to users in Brazil 297
    - notice to users in
      - Canada 298
      - Taiwan 299
    - notice to users in the European Economic Area 298
  - wireless router 38

## Z

zoom

button 13

buttons 109

photos 109