

# HP Deskjet F300 All-in-One series User Guide

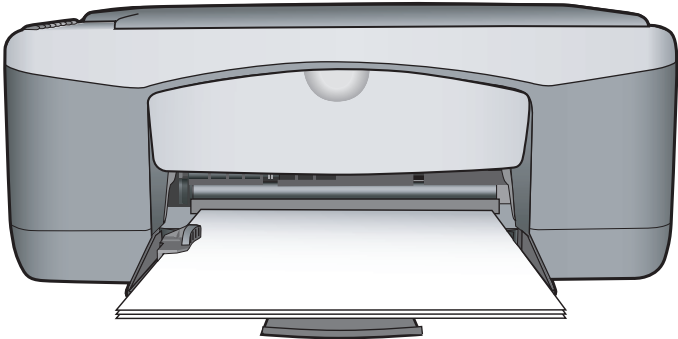

HP Deskjet F300 All-in-One series



## **User Guide**

© Copyright 2006 Hewlett-Packard Development Company, L.P.

The information contained herein is subject to change without notice.

Reproduction, adaptation or translation without prior written permission is prohibited, except as allowed under copyright laws.



Adobe and the Acrobat logo are either registered trademarks or trademarks of Adobe Systems Incorporated in the United States and/or other countries. Windows®, Windows NT®, Windows ME®, Windows XP®, and Windows 2000® are U.S. registered trademarks of Microsoft Corporation.

Intel® and Pentium® are registered trademarks of Intel Corporation.

Energy Star® and Energy Star logo® are US registered marks of the United States Environmental Protection Agency.

Publication number: Q8130-90157

February 2006

## Notice

The only warranties for HP products and services are set forth in the express warranty statements accompanying such products and services. Nothing herein should be construed as constituting an additional warranty. HP shall not be liable for technical or editorial errors or omissions contained herein.

The Hewlett-Packard Company shall not be liable for incidental or consequential damages in connection with, or arising out of the furnishing, performance, or use of this document and the program material which it describes.

**Note:** Regulatory information can be found in [Technical information](#).



It is not lawful in many places to make copies of the following items. When in doubt, check with a legal representative first.

- Governmental paper or documents:
  - Passports

- Immigration papers
- Selective service papers
- Identification badges, cards, or insignias
- Governmental stamps:
  - Postage stamps
  - Food stamps
- Checks or drafts drawn on Governmental agencies
- Paper currency, traveler's checks, or money orders
- Certificates of deposit
- Copyrighted works



**Warning** This equipment will be inoperable when main power fails.

## Safety information



**Warning** To prevent fire or shock hazard, do not expose this product to rain or any type of moisture.

Always follow basic safety precautions when using this product to reduce risk of injury from fire or electric shock.



**Warning** Potential shock hazard

1. Read and understand all instructions in the Setup Guide.
2. Use only a grounded electrical outlet when connecting the device to a power source. If you do not know whether the outlet is grounded, check with a qualified electrician.
3. Observe all warnings and instructions marked on the product.
4. Unplug this product from wall outlets before cleaning.
5. Do not install or use this product near water or when you are wet.
6. Install the product securely on a stable surface.
7. Install the product in a protected location where no one can step on or trip over the power cord, and where the power cord will not be damaged.
8. If the product does not operate normally, see the onscreen Troubleshooting help.
9. No operator-serviceable parts inside. Refer servicing to qualified service personnel.
10. Use in a well-ventilated area.
11. Use only with the power adapter supplied by HP.

# Contents

<b>1</b>	<b>HP All-in-One overview</b> .....	<b>3</b>
	The HP All-in-One at a glance.....	3
	Control panel buttons.....	4
	Status light overview.....	5
<b>2</b>	<b>Find more information</b> .....	<b>7</b>
	Sources of information.....	7
<b>3</b>	<b>Connection information</b> .....	<b>9</b>
	Supported connection types.....	9
	Connect using a USB cable.....	9
	Use printer sharing.....	9
<b>4</b>	<b>Load originals and load paper</b> .....	<b>11</b>
	Load originals.....	11
	Choose papers for printing and copying.....	11
	Load paper.....	13
	Avoid paper jams.....	17
<b>5</b>	<b>Print from your computer</b> .....	<b>19</b>
	Print from a software application.....	19
	Stop a print job.....	20
<b>6</b>	<b>Use the copy features</b> .....	<b>21</b>
	Make a copy.....	21
	Set the copy paper type.....	21
	Make multiple copies of the same original.....	21
	Stop copying.....	22
<b>7</b>	<b>Use the scan features</b> .....	<b>23</b>
	Scan an image.....	23
	Stop scanning.....	24
<b>8</b>	<b>Maintain the HP All-in-One</b> .....	<b>25</b>
	Clean the HP All-in-One.....	25
	Print a self-test report.....	26
	Work with print cartridges.....	27
<b>9</b>	<b>Order supplies</b> .....	<b>35</b>
	Order paper, or other media.....	35
	Order print cartridges.....	35
	Order other supplies.....	36
<b>10</b>	<b>Troubleshooting information</b> .....	<b>37</b>
	View the Readme file.....	37
	Setup troubleshooting.....	38
	Operational troubleshooting.....	45
<b>11</b>	<b>HP warranty and support</b> .....	<b>49</b>
	Warranty.....	49
	Get support and other information from the Internet.....	51
	Before you call HP customer support.....	51
	Access your serial number and service ID.....	51
	Call in North America during warranty.....	52
	Call elsewhere in the world.....	52

Prepare the HP All-in-One for shipment.....	54
Pack the HP All-in-One.....	54
<b>12 Technical information.....</b>	<b>57</b>
System requirements.....	57
Paper specifications.....	57
Print specifications.....	59
Copy specifications.....	60
Scan specifications.....	60
Physical specifications.....	60
Power specifications.....	60
Environmental specifications.....	60
Acoustic information.....	60
Environmental product stewardship program.....	61
Regulatory notices.....	62
<b>Index.....</b>	<b>65</b>

# 1 HP All-in-One overview

You can make copies quickly and easily from the HP All-in-One without turning on your computer. You can also use the HP All-in-One to print and scan photos and text documents by using the software installed on your computer during the initial setup.

- [The HP All-in-One at a glance](#)
- [Control panel buttons](#)
- [Status light overview](#)



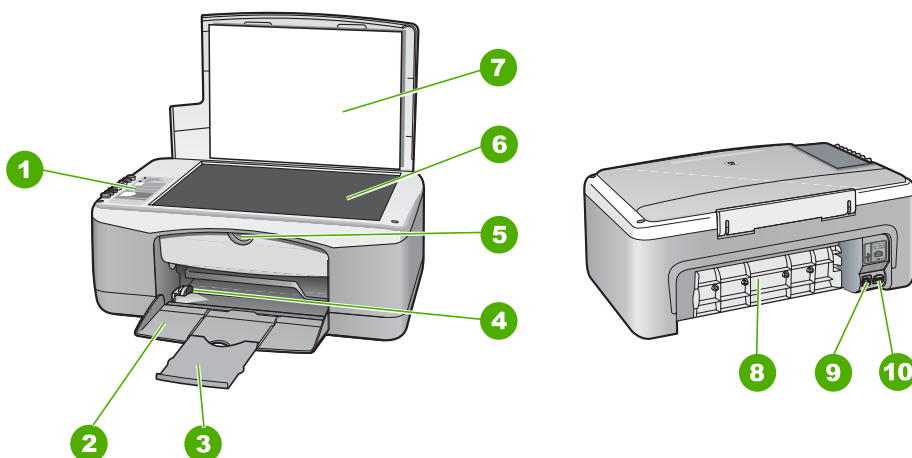

## The HP All-in-One at a glance



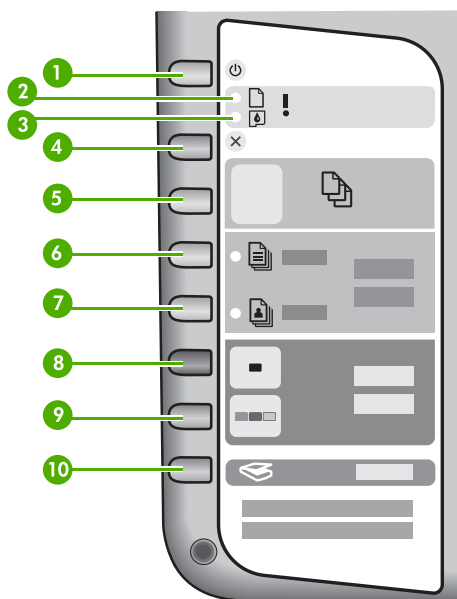



Label	Description
1	Control panel
2	Input tray
3	Tray extender
4	Paper-width guide
5	Print cartridge door
6	Glass
7	Lid backing
8	Rear door
9	Rear USB port
10	Power connection

## Control panel buttons



Label	Icon	Name and Description
1		<p><b>On:</b> Turns the HP All-in-One on or off. The <b>On</b> button is lit when the HP All-in-One is powered on. The light blinks while performing a job.</p> <p>When the HP All-in-One is off, a minimal amount of power is still supplied to the device. To completely disconnect the power supply to the HP All-in-One, turn the device off, and then unplug the power cord.</p>
2		<p><b>Check Paper light:</b> Indicates the need to load paper or remove a paper jam.</p>
3		<p><b>Check Print Cartridge light:</b> Indicates the need to reinsert the print cartridge, replace the print cartridge, or close the print cartridge door.</p>
4		<p><b>Cancel:</b> Stops a print, copy, or scan job.</p>
5		<p><b>Copies:</b> Specifies the number of copies to be printed.</p>

(continued)

Label	Icon	Name and Description
		<b>Tip</b> From the control panel, you can specify up to nine copies of an original. However, if you connect the HP All-in-One to a computer, you can use the HP Photosmart Software to specify more. When initiating more than nine copies of an original from the HP Photosmart Software, only the last digit of the number of copies is represented on the control panel. For example, if you are making 25 copies, the number 5 appears on the display.
6		<b>Plain Paper Type:</b> Changes the paper type setting to plain paper. This is the default setting for the HP All-in-One.
7		<b>Photo Paper Type:</b> Changes the paper type setting to photo paper. Make sure photo paper is loaded in the input tray.
8		<b>Start Copy Black:</b> Starts a black-and-white copy job. In certain situations (for example, after clearing a paper jam), this button resumes printing.
9		<b>Start Copy Color:</b> Starts a color copy job. In certain situations (for example, after clearing a paper jam), this button resumes printing.
10		<b>Scan:</b> Starts scanning the original currently on the glass.

## Status light overview

Several indicator lights inform you of the status of the HP All-in-One.

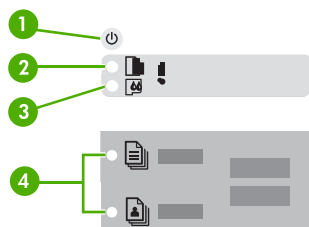

Label	Description
1	<b>On</b> button
2	Check Paper light
3	Check Print Cartridge light
4	Paper Type lights (for the <b>Plain Paper Type</b> and <b>Photo Paper Type</b> buttons)







The following table describes common situations and explains what the lights mean.

Light status	What it means
All lights are off.	The HP All-in-One is turned off. Press the <b>On</b> button to turn on the device.
The <b>On</b> light and one of the Paper Type lights are on.	The HP All-in-One is ready for printing, scanning, or copying.
The <b>On</b> light is blinking.	The HP All-in-One is busy printing, scanning, copying, or aligning the print cartridges.
The <b>On</b> light blinks quickly for 3 seconds and then is on steady.	You pressed a button while the HP All-in-One is already busy printing, scanning, copying, or aligning the print cartridges.
The <b>On</b> light blinks for 20 seconds and then is on steady.	You pressed the <b>Scan</b> button and there was no response from the computer.
The Check Paper light is blinking.	<ul style="list-style-type: none"> <li>• The HP All-in-One is out of paper.</li> <li>• The HP All-in-One has a paper jam.</li> <li>• The paper size setting does not match the paper size detected in the input tray.</li> </ul>
The Check Print Cartridge light is blinking.	<ul style="list-style-type: none"> <li>• The print cartridge door is open.</li> <li>• The print cartridges are missing or not seated correctly.</li> <li>• The tape was not removed from the print cartridge.</li> <li>• The print cartridge is not intended for use in this HP All-in-One.</li> <li>• The print cartridge might be defective.</li> </ul>
The <b>On</b> , Check Paper, and Check Print Cartridge lights are blinking.	<p>Scanner failure.</p> <p>Turn off the HP All-in-One, then on again. If the problem persists, contact HP Support.</p>
All lights are blinking.	<p>The HP All-in-One has a fatal error.</p> <ol style="list-style-type: none"> <li>1. Turn the HP All-in-One off.</li> <li>2. Unplug the power cord.</li> <li>3. Wait a minute, then plug the power cord back in.</li> <li>4. Turn the HP All-in-One back on.</li> </ol> <p>If the problem persists, contact HP Support.</p>

# 2 Find more information

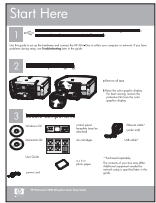
You can access a variety of resources, both printed and onscreen, that provide information about setting up and using the HP All-in-One.

## Sources of information

	<p><b>Setup Guide</b></p> <p>The Setup Guide provides instructions for setting up the HP All-in-One and installing software. Make sure you follow the steps in the Setup Guide in order.</p> <p>If you have problems during setup, see <a href="#">Troubleshooting</a> in the last section of the Setup Guide, or see <a href="#">Troubleshooting information</a> in this guide.</p>
	<p><b>User Guide</b></p> <p>This guide contains information on how to use the HP All-in-One, including troubleshooting tips and step-by-step instructions. It also provides additional setup instructions to supplement those in the Setup Guide.</p>
	<p><b>HP Photosmart Software Tour (Windows)</b></p> <p>The HP Photosmart Software Tour is a fun, interactive way to get a brief overview of the software included with the HP All-in-One. You will learn how the software you installed with the HP All-in-One can help you edit, organize, and print your photos.</p>
	<p><b>Onscreen Help</b></p> <p>The onscreen Help provides detailed instructions on features of the HP All-in-One that are not described in this guide, including features that are only available using the software you installed with the HP All-in-One.</p>
	<p><b>HP Photosmart Software Help (Windows)</b></p> <ul style="list-style-type: none"><li>• The <b>Get the most out of your help</b> topic provides information about using the onscreen Help to find instructions for using the HP Photosmart Software or the HP All-in-One. The topic also provides information on how to view animated videos of common tasks you can perform with your software and device.</li><li>• The <b>Get step-by-step instructions</b> topic provides information on using the HP Photosmart Software with the HP All-in-One.</li></ul>

- The **Explore what you can do** topic provides more information about the practical and creative things you can do with the HP Photosmart Software and the HP All-in-One.
- If you need further assistance or want to check for HP software updates, see the **Troubleshooting and support** topic.

#### HP Photosmart Mac Help (Mac)

- The **How Do I?** topic provides access to animated videos that show you how to perform common tasks.
- The **Get Started** topic provides information about importing, modifying, and sharing your images.
- The **Use Help** topic provides information about finding information in the onscreen Help.



#### Readme

The Readme file contains the most recent information which might not be found in other publications.

Install the software to access the Readme file.

[www.hp.com/support](http://www.hp.com/support)

If you have Internet access, you can get help and support from the HP website. This website offers technical support, drivers, supplies, and ordering information.

# 3 Connection information

The HP All-in-One comes equipped with a USB port so you can connect directly to a computer using a USB cable. You can also share your printer over an existing Ethernet network using a computer as a print server.

- [Supported connection types](#)
- [Connect using a USB cable](#)
- [Use printer sharing](#)

## Supported connection types

Description	Recommended number of connected computers for best performance	Supported software features	Setup instructions
USB connection	One computer connected with a USB cable to the rear USB 1.1 full speed peripheral connection port on the HP All-in-One. The port is compatible with 2.0 high speed hardware.	All features are supported.	Follow the Setup Guide for detailed instructions.
Printer sharing	Five. The host computer must be on at all times in order to print from the other computers.	All features resident on the host computer are supported. Only printing is supported from the other computers.	Follow the instructions in <a href="#">Use printer sharing</a> .

## Connect using a USB cable

Refer to the Setup Guide that came with the HP All-in-One for detailed instructions on using a USB cable to connect a computer to the rear USB port.

## Use printer sharing

If your computer is on a network, and another computer on the network has an HP All-in-One connected to it by a USB cable, you can print to that printer using printer sharing.

The computer directly connected to the HP All-in-One acts as the **host** for the printer and has full software functionality. The other computer, which is referred to as a

**client**, has access only to the print features. You must perform other functions from the host computer or from the control panel on the HP All-in-One.

### To enable printer sharing on a Windows computer

- Refer to the user guide that came with your computer or see the Windows onscreen Help.

### To enable printer sharing on a Mac

1. On both the client and host computers, do the following:
  - a. Click **System Preferences** in the Dock, or, from the **Apple** menu, choose **System Preferences**.  
The **System Preferences** dialog appears.
  - b. In the **Internet & Network** area, click **Sharing**.
  - c. From the **Services** tab, click **Printer Sharing**.
2. On the host computer, do the following:
  - a. Click **System Preferences** in the Dock, or, from the **Apple** menu, choose **System Preferences**.  
The **System Preferences** dialog appears.
  - b. In the **Hardware** area, click **Print & Fax**.
  - c. Do one of the following, depending on your OS:
    - (OS 10.2.8 or 10.3.x) From the **Printing** tab, click the check box to **Share my printers with other computers**.
    - (OS 10.4.x) Click **Sharing**, click the check box to **Share this printer with other computers**, and then select the printer to share.

# 4 Load originals and load paper

You can load many different types and sizes of paper in the HP All-in-One, including letter or A4 paper, photo paper, transparencies, and envelopes.

- [Load originals](#)
- [Choose papers for printing and copying](#)
- [Load paper](#)
- [Avoid paper jams](#)

## Load originals

You can copy or scan up to letter- or A4-size originals by loading them on the glass.

### To load an original on the glass

1. Lift the lid on the HP All-in-One.
2. Place your original print side down on the left front corner of the glass.



**Tip** For more help on loading an original, refer to the engraved guides along the edge of the glass.

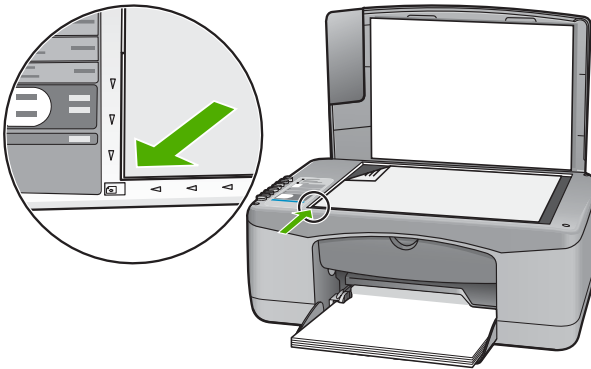

3. Close the lid.

## Choose papers for printing and copying

You can use different types and sizes of paper in the HP All-in-One. Review the following recommendations to get the best printing and copying quality. Whenever you change paper types or sizes, remember to change those settings.

- [Recommended papers for printing and copying](#)
- [Papers to avoid](#)

## Recommended papers for printing and copying

If you want the best print quality, HP recommends using HP papers that are specifically designed for the type of project you are printing. If you are printing photos, for example, load HP Premium or HP Premium Plus photo paper in the input tray.



**Note 1** This device supports 10 x 15 cm (4 x 6 inch) with tab, A4-, letter-, and legal- (US only) size paper only.

**Note 2** To achieve a borderless print, you must use 10 x 15 cm (4 x 6 inch) paper with tab. The HP All-in-One prints to the edge of three sides of the paper. When you remove the tab from the fourth side, you have a borderless print.

To order HP papers and other supplies, go to [www.hp.com/learn/suresupply](http://www.hp.com/learn/suresupply). If prompted, choose your country/region, follow the prompts to select your product, and then click one of the shopping links on the page.



**Note** At this time, this portion of the HP website is available in English only.

## Papers to avoid

Using paper that is too thin or too thick, paper that has a slick texture, or paper that stretches easily can cause paper jams. Using paper that has a heavy texture or does not accept ink can cause printed images to smear, bleed, or not fill in completely.

### Papers to avoid for all print and copy jobs

- Any size paper other than those listed in the Technical specifications chapter. For more information, see [Technical information](#).
- Paper with cutouts or perforations (unless specifically designed for use with HP inkjet devices).
- Highly textured stock, such as linen. It might not print evenly, and the ink can bleed into these papers.
- Extremely smooth, shiny, or coated papers not specifically designed for the HP All-in-One. They can jam the HP All-in-One or repel the ink.
- Multi-part forms, such as duplicate and triplicate forms. They can wrinkle or get stuck, and the ink is more likely to smear.
- Envelopes with clasps or windows. They can get stuck in the rollers and cause paper jams.
- Banner paper.
- 10 x 15 cm (4 x 6 inch) photo paper without tabs.

### Additional papers to avoid when copying

- Envelopes.
- Transparency film other than HP Premium Inkjet Transparency Film or HP Premium Plus Inkjet Transparency Film.
- Iron-On Transfers.
- Greeting card paper.

# Load paper

This section describes the procedure for loading different types and sizes of paper into the HP All-in-One for your copies or printouts.



**Tip** To help prevent rips, wrinkles, and curled or bent edges, store all paper flat in a resealable bag. If the paper is not stored properly, extreme changes in temperature and humidity might result in curled paper that does not work well in the HP All-in-One.

- [Load full-size paper](#)
- [Load 10 x 15 cm \(4 x 6 inch\) photo paper](#)
- [Load envelopes](#)
- [Load other types of paper](#)

## Load full-size paper

You can load many types of letter or A4 paper into the input tray of the HP All-in-One.

### To load full-size paper

1. Slide the paper-width guide to its outermost position.

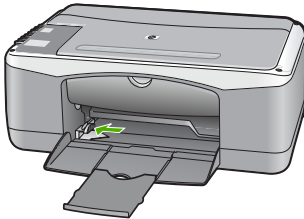

2. Tap a stack of paper on a flat surface to align the edges, and then check the paper for the following:
  - Make sure it is free of rips, dust, wrinkles, and curled or bent edges.
  - Make sure all the paper in the stack is the same size and type.
3. Insert the stack of paper into the input tray with the short edge forward and the print side down. Slide the stack of paper forward until it stops.

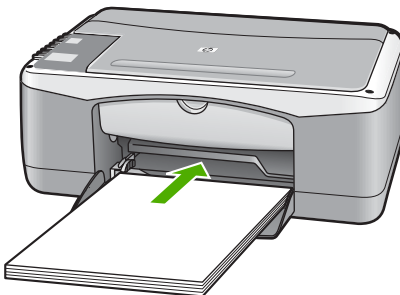



 **Caution** Make sure that the HP All-in-One is idle and silent when you load paper into the input tray. If the HP All-in-One is servicing the print cartridges or otherwise engaged in a task, the paper stop inside the device might not be in place. You could push the paper too far forward, causing the HP All-in-One to eject blank pages.

 **Tip** If you are using letterhead, insert the top of the page first with the print side down. For more help on loading full-size paper and letterhead, refer to the diagram engraved in the base of the input tray.

- Slide the paper-width guide inward until it stops at the edge of the paper. Do not overload the input tray; make sure the stack of paper fits within the input tray and is no higher than the top of the paper-width guide.

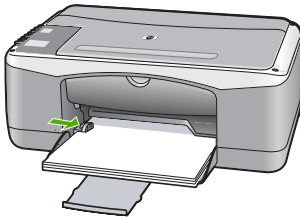

- Flip the tray extender up toward you.

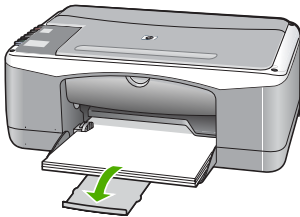

### Load 10 x 15 cm (4 x 6 inch) photo paper

You can load 10 x 15 cm (4 x 6 inch) photo paper into the input tray of the HP All-in-One. For the best results, use 10 x 15 cm (4 x 6 inch) HP Premium Plus Photo Paper or HP Premium Photo Paper with tab.



**Note** For borderless printing, the HP All-in-One only supports printing 10 x 15 cm (4 x 6 inch) paper with tab.



**Tip** To help prevent rips, wrinkles, and curled or bent edges, store all paper flat in a resealable bag. If the paper is not stored properly, extreme changes in temperature and humidity might result in curled paper that does not work well in the HP All-in-One.

### To load 10 x 15 cm ( 4 x 6 inch) photo paper with tab in the input tray

1. Remove all paper from the input tray.
2. Insert the stack of photo paper into the far-right side of the input tray with the short edge forward and the print side down. Slide the stack of photo paper forward until it stops.

Load the photo paper so that the tabs are closest to you.



**Tip** For more help on loading small-size photo paper, refer to the guides engraved in the base of the input tray for loading photo paper.

3. Slide the paper-width guide inward until it stops at the edge of the paper. Do not overload the input tray; make sure the stack of paper fits within the input tray and is no higher than the top of the paper-width guide.

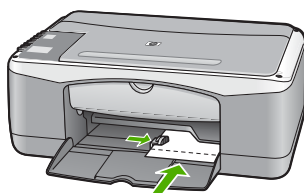

For best results, set the paper type and paper size before copying or printing.

### Load envelopes

You can load one or more envelopes into the input tray of the HP All-in-One. Do not use shiny or embossed envelopes or envelopes that have clasps or windows.



**Note** For specific details on how to format text for printing on envelopes, consult the help files in your word processing software. For best results, consider using a label for the return address on envelopes.

### To load envelopes

1. Remove all paper from the input tray.
2. Insert one or more envelopes into the far-right side of the input tray with the envelope flaps up and on the left. Slide the stack of envelopes forward until it stops.



**Tip** For more help on loading envelopes, refer to the diagram engraved in the base of the input tray.

3. Slide the paper-width guide inward against the stack of envelopes until it stops. Do not overload the input tray; make sure the stack of envelopes fits within the input tray and is not higher than the top of the paper-width guide.

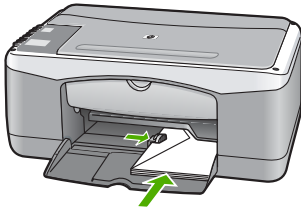

## Load other types of paper

The following papers require extra attention to load them properly.



**Note** Not all paper sizes and paper types are available with all the functions on the HP All-in-One. Some paper sizes and paper types can only be used if you are starting a print job from the **Print** dialog box in a software application. They are not available for copying. Papers that are only available for printing from a software application are indicated as such.

### HP Premium Inkjet Transparency Film and HP Premium Plus Inkjet Transparency Film

- Insert the film so that the white transparency strip (with arrows and the HP logo) is on top and is going into the input tray first.



**Note** The HP All-in-One cannot automatically detect the paper size or paper type. For best results, set the paper type to transparency film before printing or copying onto transparency film.

### HP Iron-On Transfers (for printing only)

1. Flatten the transfer sheet completely before using it; do not load curled sheets.



**Tip** To prevent curling, keep transfer sheets sealed in the original package until you are ready to use them.

2. Locate the blue stripe on the nonprinting side of the transfer paper and then manually feed one sheet at a time into the input tray with the blue stripe facing up.

### HP Greeting Cards, HP Photo Greeting Cards, or HP Textured Greeting Cards (for printing only)

- Insert a small stack of HP greeting card paper into the input tray with the print side down; slide the stack of cards forward until it stops.



**Tip** Make sure the area on which you want to print is inserted first, facing down in the input tray.

### HP Inkjet labels (for printing only)

1. Always use letter or A4 label sheets designed for use with HP inkjet devices (such as HP inkjet labels), and make sure that the labels are no more than two

years old. Labels on older sheets might peel off when the paper is pulled through the HP All-in-One, causing subsequent paper jams.

2. Fan the stack of labels to make sure none of the pages are sticking together.
3. Place a stack of label sheets on top of full-size plain paper in the input tray, label side down. Do not insert labels one sheet at a time.

For best results, set the paper type and paper size before copying or printing.

## Avoid paper jams

To help avoid paper jams, follow these guidelines.

- Remove printed papers from the output tray frequently.
- Prevent curled or wrinkled paper by storing all unused paper flat in a resealable bag.
- Ensure that paper loaded in the input tray lays flat and the edges are not bent or torn.
- Do not combine different paper types and paper sizes in the input tray; the entire stack of paper in the input tray must be the same size and type.
- Adjust the paper-width guide in the input tray to fit snugly against all paper. Make sure the paper-width guide does not bend the paper in the input tray.
- Do not force paper too far forward in the input tray.
- Use paper types that are recommended for the HP All-in-One.



# 5 Print from your computer

The HP All-in-One can be used with any software application that allows printing. You can print a range of projects, such as borderless images, newsletters, greeting cards, iron-on transfers, and posters.

- [Print from a software application](#)
- [Stop a print job](#)

## Print from a software application

Most print settings are automatically handled by the software application you are printing from or by HP ColorSmart technology. You need to change the settings manually only when you change print quality, print on specific types of paper or transparency film, or use special features.

For more information about printing from your computer, see the onscreen Help that came with the HP All-in-One.

### To print from a software application (Windows)

1. Make sure you have paper loaded in the input tray.
2. On the **File** menu in your software application, click **Print**.
3. Make sure the HP All-in-One is the selected printer.
4. If you need to change settings, click the button that opens the **Properties** dialog box.

Depending on your software application, this button might be called **Properties**, **Options**, **Printer Setup**, **Printer**, or **Preferences**.

5. Select the appropriate options for your print job by using the features available on the various tabs.
6. Click **OK** to close the **Properties** dialog box.
7. Click **Print** or **OK** to begin printing.

### To print from a software application (Mac)

1. Make sure you have paper loaded in the input tray.
2. From the **File** menu in your software application, choose **Page Setup**.
3. Make sure the HP All-in-One is the selected printer.
4. Specify the page attributes:
  - Choose the paper size.
  - Select the orientation.
  - Enter the scaling percentage.
5. Click **OK**.
6. From the **File** menu in your software application, choose **Print**.  
The **Print** dialog box appears, and the **Copies & Pages** panel opens.
7. Change the print settings for each option in the pop-up menu, as appropriate for your project.
8. Click **Print** to begin printing.

## Stop a print job

Although you can stop a print job from either the HP All-in-One or the computer, HP recommends you stop it from the HP All-in-One for best results.

### To stop a print job from the HP All-in-One

- Press **Cancel** on the control panel. If the print job does not stop, press **Cancel** again.

It can take a few moments for printing to be cancelled.

# 6 Use the copy features

The HP All-in-One allows you to produce high-quality color and black-and-white copies on a variety of paper types. You can enlarge or reduce the size of an original to fit a specific paper size, adjust the copy quality, and make high-quality copies of photos, including borderless copies.

- [Make a copy](#)
- [Set the copy paper type](#)
- [Make multiple copies of the same original](#)
- [Stop copying](#)

## Make a copy

You can make quality copies from the control panel.

### To make a copy from the control panel

1. Make sure you have paper loaded in the input tray.
2. Place your original print side down on the left front corner of the glass.
3. Press **Start Copy Black**.



**Tip** To make a fast copy, press and hold down the **Scan** button while you press either **Start Copy Black** or **Start Copy Color**.

## Set the copy paper type

You can set the paper type for copying to either **Plain** or **Photo**.

### To set the paper type for copies

1. Make sure you have paper loaded in the input tray.
2. Place your original print side down on the left front corner of the glass.
3. Press the **Plain Paper Type** or **Photo Paper Type** button.  
Copies made on photo paper are automatically made using Best quality. Copies made on plain paper are automatically made using Normal quality.
4. Press **Start Copy Black** or **Start Copy Color**.

## Make multiple copies of the same original

You can set the number of copies from the control panel or from the software that you installed with the HP All-in-One.

### To make multiple copies of an original from the control panel

1. Make sure you have paper loaded in the input tray.
2. Place your original print side down on the left front corner of the glass.



3. Press the **Copies** button to increase the number of copies up to a maximum of 9.



**Tip** Use the software that you installed with the HP All-in-One to set the number of copies higher than 9.

4. Press **Start Copy Black** or **Start Copy Color**.

In this example, the HP All-in-One makes six copies of the original 10 x 15 cm (4 x 6 inch) photo.

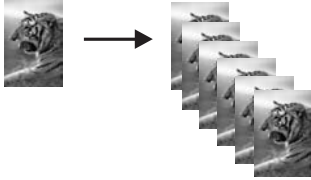

## Stop copying

### To stop copying

- Press **Cancel** on the control panel.

# 7 Use the scan features

Scanning is the process of converting text and pictures into an electronic format for your computer. You can scan almost anything (photos, magazine articles and text documents) on the HP All-in-One.

You can use the scanning features of the HP All-in-One to do the following:

- Scan text from an article into your word processor and quote it in a report.
- Print business cards and brochures by scanning a logo and using it in your publishing software.
- Send photos to friends and relatives by scanning your favorite prints and including them in e-mail messages.
- Create a photographic inventory of your house or office.
- Archive treasured photos in an electronic scrapbook.
- [Scan an image](#)
- [Stop scanning](#)

## Scan an image

You can start a scan from your computer or from the HP All-in-One. This section explains how to scan from the control panel of the HP All-in-One only.

To use the scan features, the HP All-in-One and computer must be connected and turned on. The HP Photosmart Software (Windows) or HP Photosmart Mac Software (Mac) must also be installed and running on your computer prior to scanning.

- On a Windows computer, look for the **HP Digital Imaging Monitor** icon in the Windows system tray (at the lower right side of the screen, near the time) to verify the software is running.



**Note** Closing the **HP Digital Imaging Monitor** icon in the Windows system tray can cause the HP All-in-One to lose some of its scan functionality. If this happens, you can restore full functionality by restarting your computer or by starting the HP Photosmart Software.

- On a Mac, the software is always running.



**Tip** You can use the HP Photosmart Software (Windows) or HP Photosmart Mac Software (Mac) to scan images, including panorama images. Using this software, you can also edit, print, and even share your scanned images. For more information, see the onscreen Help that came with the HP All-in-One.

### To scan to a computer

1. Place your original print side down on the left front corner of the glass.
2. Press **Scan**.  
A preview image of the scan appears on your computer, where you can edit it.
3. Make any edits to the preview image, and then click **Accept** when you are finished.

## Stop scanning

### To stop scanning

→ Press **Cancel** on the control panel.

# 8 Maintain the HP All-in-One

The HP All-in-One requires little maintenance. Sometimes you might want to clean the glass and lid backing to remove surface dust and ensure that your copies and scans remain clear. You will also need to replace, align, or clean your print cartridges from time to time. This section provides instructions for keeping the HP All-in-One in top working condition. Perform these simple maintenance procedures as necessary.

- [Clean the HP All-in-One](#)
- [Print a self-test report](#)
- [Work with print cartridges](#)

## Clean the HP All-in-One

To ensure that your copies and scans remain clear, you might need to clean the glass and lid backing. You might also want to dust the exterior of the HP All-in-One.

- [Clean the exterior](#)
- [Clean the glass](#)
- [Clean the lid backing](#)

### Clean the exterior

Use a soft cloth or slightly moistened sponge to wipe dust, smudges, and stains off the case. The interior of the HP All-in-One does not require cleaning. Keep fluids away from the control panel and the interior of the HP All-in-One.



**Caution** To avoid damage to the exterior of the HP All-in-One, do not use alcohol or alcohol-based cleaning products.

### Clean the glass

Glass that is dirty from fingerprints, smudges, hair, and dust on the main glass surface slows down performance and affects the accuracy of some features.

#### To clean the glass

1. Turn off the HP All-in-One, unplug the power cord, and raise the lid.
2. Clean the glass with a soft cloth or sponge slightly moistened with a nonabrasive glass cleaner.



**Caution** Do not use abrasives, acetone, benzene, or carbon tetrachloride on the glass, since they can damage it. Do not place or spray liquid directly on the glass. The liquid might seep under the glass and damage the device.

3. Dry the glass with a chamois or cellulose sponge to prevent spotting.
4. Plug in the power cord, and then turn on the HP All-in-One.

## Clean the lid backing

Minor debris can accumulate on the white document backing located underneath the lid of the HP All-in-One.

### To clean the lid backing

1. Turn off the HP All-in-One, unplug the power cord, and raise the lid.
2. Clean the white document backing with a soft cloth or sponge slightly moistened with a mild soap and warm water.  
Wash the backing gently to loosen debris. Do not scrub the backing.
3. Dry the backing with a chamois or soft cloth.



**Caution** Do not use paper-based wipes, as these might scratch the backing.

4. If further cleaning is needed, repeat the previous steps using isopropyl (rubbing) alcohol, and wipe the backing thoroughly with a damp cloth to remove any residual alcohol.



**Caution** Be careful not to spill alcohol on the glass or exterior of the HP All-in-One, as this might damage the device.

5. Plug in the power cord, and then turn on the HP All-in-One.

## Print a self-test report

If you are experiencing problems with printing, print a self-test report before you replace the print cartridges. This report provides useful information on several aspects of your device, including your print cartridges.

### To print a self-test report

1. Load letter or A4 unused plain white paper into the input tray.
2. Press and hold the **Cancel** button and then press the **Start Copy Color** button. The HP All-in-One prints a self-test report, which might indicate the source of the printing problem. A sample of the ink test area of the report is shown below.

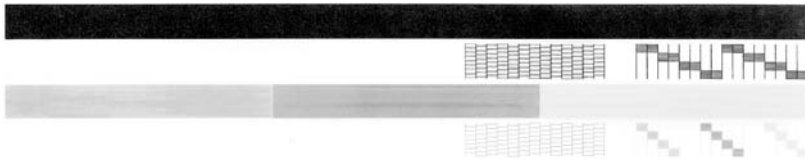

3. Make sure the test patterns show a complete grid and the thick color lines are complete.
  - If more than a few lines in a pattern are broken, this might indicate a problem with the nozzles. You might need to clean the print cartridges.
  - If the black line is missing, faded, streaked, or shows lines, this might indicate a problem with the black print cartridge in the right slot.
  - If any of the color lines are missing, faded, streaked, or show lines, this might indicate a problem with the tri-color print cartridge in the left slot.

# Work with print cartridges

To ensure the best print quality from the HP All-in-One, you will need to perform some simple maintenance procedures. This section provides guidelines for handling the print cartridges and instructions for replacing, aligning, and cleaning the print cartridges.

You might also need to check your print cartridges if the Check Print Cartridge light is on. This might mean that the print cartridges are not installed properly or are missing, the plastic tape has not been removed from the print cartridges, the print cartridges are out of ink, or the print carriage is blocked.

- [Handle the print cartridges](#)
- [Replace the print cartridges](#)
- [Align the print cartridges](#)
- [Clean the print cartridges](#)
- [Clean the print cartridge contacts](#)

## Handle the print cartridges

Before you replace or clean a print cartridge, you should know the part names and how to handle the print cartridges.

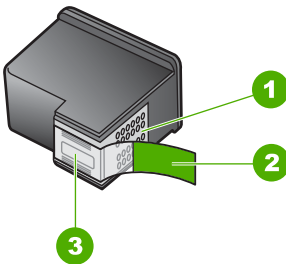

1	Copper-colored contacts
2	Plastic tape with pink pull tab (must be removed before installing)
3	Ink nozzles under tape

Hold the print cartridges by their black plastic sides, with the label on top. Do not touch the copper-colored contacts or the ink nozzles.



**Note** Handle the print cartridges carefully. Dropping or jarring cartridges can cause temporary printing problems, or even permanent damage.

## Replace the print cartridges

Follow these instructions when the ink level is low.



**Note** When the ink level for the print cartridge is low, a message appears on your computer screen. You can also check the ink levels by using the software installed with the HP All-in-One.

When you receive a low-ink warning message, make sure you have a replacement print cartridge available. You should also replace the print cartridges when you see faded text or if you experience print quality issues related to the print cartridges.

To order print cartridges for the HP All-in-One, go to [www.hp.com/learn/suresupply](http://www.hp.com/learn/suresupply). If prompted, choose your country/region, follow the prompts to select your product, and then click one of the shopping links on the page.

For a list of print cartridge numbers, see the back cover of this guide.

### To replace the print cartridges

1. Make sure the HP All-in-One is on.



**Caution** If the HP All-in-One is off when you open the print cartridge door to access the print cartridges, the HP All-in-One will not release the cartridges for changing. You might damage the HP All-in-One if the print cartridges are not docked safely on the right side when you try to remove them.

2. Open the print cartridge door.

The print carriage moves to the center of the HP All-in-One.

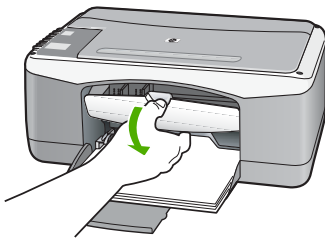

3. Wait until the print carriage is idle and silent, and then lightly press down on a print cartridge to release it.

If you are replacing the tri-color print cartridge, remove the print cartridge from the slot on the left.

If you are replacing the black or photo print cartridge, remove the print cartridge from the slot on the right.

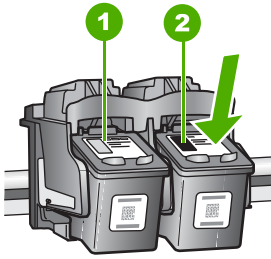

- |   |   |
|---|---|
| 1 | Print cartridge slot for the tri-color print cartridge        |
| 2 | Print cartridge slot for the black and photo print cartridges |

- Pull the print cartridge toward you out of its slot.
- If you are removing the black print cartridge in order to install the photo print cartridge, store the black print cartridge in the print cartridge protector or an airtight plastic container.

If you are removing the print cartridge because it is low or out of ink, recycle the print cartridge. The HP Inkjet Supplies Recycling Program is available in many countries/regions, and lets you recycle used print cartridges free of charge. For more information, go to the following website:

[www.hp.com/hpinfo/globalcitizenship/environment/recycle/inkjet.html](http://www.hp.com/hpinfo/globalcitizenship/environment/recycle/inkjet.html)

- Remove the new print cartridge from its packaging and, being careful to touch only the black plastic, gently remove the plastic tape by using the pink pull tab.

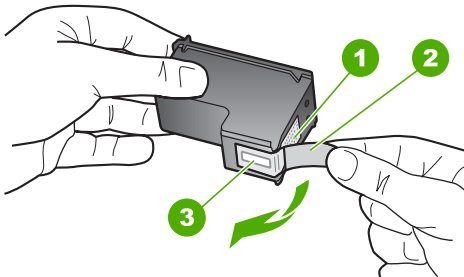

- |   |   |
|---|---|
| 1 | Copper-colored contacts   |
| 2 | Plastic tape with pink pull tab (must be removed before installing) |
| 3 | Ink nozzles under tape  |



**Caution** Do not touch the copper-colored contacts or ink nozzles. Touching these parts can result in clogs, ink failure, and bad electrical connections.





- Slide the new print cartridge forward into the empty slot. Then gently push on the upper part of the print cartridge forward until it clicks into the socket.  
If you are installing the tri-color print cartridge, slide it into the left slot.  
If you are installing a black or photo print cartridge, slide it into the right slot.

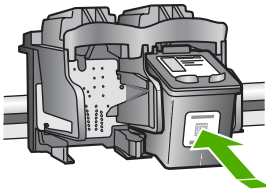

- Close the print cartridge door.

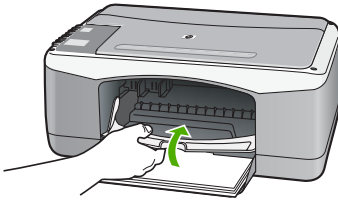

- If the print cartridge alignment sheet prints, load it on the left front corner of the glass with the top of the page to the left.

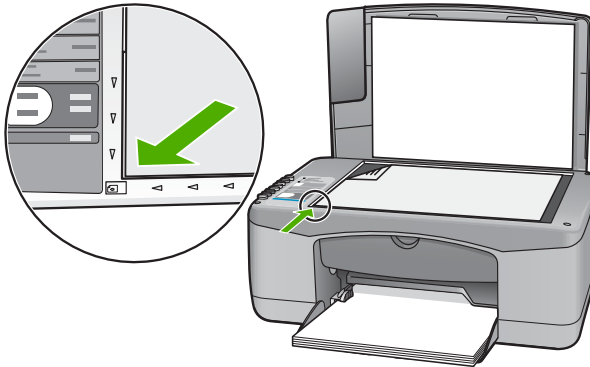

- Press the **Scan** button.  
The HP All-in-One aligns the print cartridges. Recycle or discard the print cartridge alignment sheet.

### Align the print cartridges

The HP All-in-One prompts you to align cartridges every time you install or replace a print cartridge. You can also align the print cartridges at any time from the control panel or by using the software you installed with the HP All-in-One. Aligning the print cartridges ensures high-quality output.



**Note** If you remove and reinstall the same print cartridge, the HP All-in-One will not prompt you to align the print cartridges. The HP All-in-One remembers the alignment values for that print cartridge, so you do not need to realign the print cartridges.

### To align newly installed print cartridges

1. Make sure you have letter or A4 unused plain white paper loaded in the input tray. The HP All-in-One prints a print cartridge alignment sheet.



**Note** If you have colored paper loaded in the input tray when you align the print cartridges, the alignment will fail. Load unused plain white paper into the input tray, and then try the alignment again.

If the alignment fails again, you might have a defective sensor or print cartridge. Contact HP Support. Go to [www.hp.com/support](http://www.hp.com/support). If prompted, choose your country/region, and then click **Contact HP** for information on calling for technical support.

2. Load the print cartridge alignment sheet on the left front corner of the glass with the top of the page to the left.
3. Press the **Scan** button.  
The HP All-in-One aligns the print cartridges. Recycle or discard the print cartridge alignment sheet.

### Clean the print cartridges

Use this feature when the self-test report shows streaking, white lines through any of the lines of color or when a color is muddy after installing a print cartridge for the first time. Do not clean print cartridges unnecessarily, as this wastes ink and shortens the life of the ink nozzles.

#### To clean the print cartridges from the HP Photosmart Software

1. Load letter, A4, or legal unused plain white paper into the input tray.
2. In the **HP Solution Center**, click **Settings**, point to **Print Settings**, and then click **Printer Toolbox**.



**Note** You can also open the **Printer Toolbox** from the **Print Properties** dialog box. In the **Print Properties** dialog box, click the **Services** tab, and then click **Service this device**.

The **Printer Toolbox** appears.

3. Click the **Device Services** tab.
4. Click **Clean the Print Cartridges**.
5. Follow the prompts until you are satisfied with the quality of the output, and then click **Done**.

If copy or print quality still seems poor after you clean the print cartridges, try cleaning the print cartridge contacts before replacing the affected print cartridge.

### To clean the print cartridges from the HP Photosmart Mac Software

1. Load letter, A4, or legal unused plain white paper into the input tray.
2. In the HP Photosmart Studio task bar, click **Devices**.  
The **HP Device Manager** window appears.
3. Make sure the HP All-in-One is selected in the **Devices** pop-up menu.
4. From the **Information and Settings** pop-up menu, choose **Maintain Printer**.  
The **Select Printer** window appears.
5. If the **Select Printer** dialog box appears, choose the HP All-in-One, and then click **Launch Utility**.  
The **HP Printer Utility** window appears.
6. Click **Clean** in the **Configuration Settings Panel**.
7. Click **Clean**.
8. Follow the prompts until you are satisfied with the quality of the output, and then close the **HP Printer Utility**.  
If copy or print quality still seems poor after you clean the print cartridges, try cleaning the print cartridge contacts before replacing the affected print cartridge.

### Clean the print cartridge contacts

Clean the print cartridge contacts if you get repeated messages on your computer screen prompting you to check a print cartridge after you already have cleaned or aligned the print cartridges, or if the Check Print Cartridge light is blinking.

Before cleaning the print cartridge contacts, remove the print cartridge and verify that nothing is covering the print cartridge contacts, then reinstall the print cartridge. If you continue to get messages to check the print cartridges, clean the print cartridge contacts.

Make sure you have the following materials available:

- Dry foam rubber swabs, lint-free cloth, or any soft material that will not come apart or leave fibers.



**Tip** Coffee filters are lint-free and work well for cleaning print cartridges.

- Distilled, filtered, or bottled water (tap water might contain contaminants that can damage the print cartridges).



**Caution** Do **not** use platen cleaners or alcohol to clean the print cartridge contacts. These can damage the print cartridge or the HP All-in-One.

### To clean the print cartridge contacts

1. Turn on the HP All-in-One and open the print cartridge door.  
The print carriage moves to the center of the HP All-in-One.
2. Wait until the print carriage is idle and silent, and then unplug the power cord from the back of the HP All-in-One.
3. Lightly press down on the print cartridge to release it, and then pull it toward you out of the slot.



**Note** Do not remove both print cartridges at the same time. Remove and clean each print cartridge one at a time. Do not leave a print cartridge outside the HP All-in-One for more than 30 minutes.

4. Inspect the print cartridge contacts for ink and debris buildup.
5. Dip a clean foam rubber swab or lint-free cloth into distilled water, and squeeze any excess water from it.
6. Hold the print cartridge by its sides.
7. Clean only the copper-colored contacts. Allow the print cartridges to dry for approximately ten minutes.

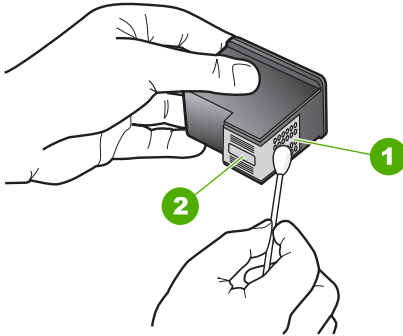

1	Copper-colored contacts
2	Ink nozzles (do not clean)

8. Slide the print cartridge back into the slot. Push the print cartridge forward until it clicks into place.
9. Repeat if necessary for the other print cartridge.
10. Gently close the print cartridge door and plug the power cord into the back of the HP All-in-One.



# 9 Order supplies

You can order HP products, such as recommended types of paper and print cartridges, online from the HP website.

- [Order paper, or other media](#)
- [Order print cartridges](#)
- [Order other supplies](#)

## Order paper, or other media

To order HP papers and other supplies, such as HP Premium Photo Papers or HP All-in-One Paper, go to [www.hp.com/learn/suresupply](http://www.hp.com/learn/suresupply). If prompted, choose your country/region, follow the prompts to select your product, and then click one of the shopping links on the page.

## Order print cartridges

For a list of print cartridge numbers, see the back cover of this guide. You can also use the software that came with the HP All-in-One to find out the reorder number for all the print cartridges. You can order print cartridges online from the HP website. Additionally, you can contact a local HP reseller to find out the correct print cartridge reorder numbers for your device and purchase print cartridges.

To order HP papers and other supplies, go to [www.hp.com/learn/suresupply](http://www.hp.com/learn/suresupply). If prompted, choose your country/region, follow the prompts to select your product, and then click one of the shopping links on the page.



**Note** Ordering print cartridges online is not supported in all countries/regions. If it is not supported in your country/region, contact a local HP reseller for information about purchasing print cartridges.

### To order print cartridges through the HP Photosmart Software

1. In the **HP Solution Center**, click **Settings**, point to **Print Settings**, and then click **Printer Toolbox**.



**Note** You can also open the **Printer Toolbox** from the **Print Properties** dialog box. In the **Print Properties** dialog box, click the **Services** tab, and then click **Service this device**.

2. Click the **Estimated Ink Levels** tab.
3. Click **Print Cartridge Ordering Information**.  
The print cartridge reorder numbers appear.
4. Click **Order Online**.  
HP sends detailed printer information, including model number, serial number, and ink supply levels, to an authorized online reseller. The supplies you need are preselected; you can change quantities, add or remove items, and then check out.

**To find out the reorder number through the HP Photosmart Mac Software**

1. In the HP Photosmart Studio task bar, click **Devices**.  
The **HP Device Manager** window appears.
2. Make sure the HP All-in-One is selected in the **Devices** pop-up menu.
3. From the **Information and Settings** pop-up menu, choose **Maintain Printer**.  
The **Select Printer** window appears.
4. If the **Select Printer** dialog box appears, choose the HP All-in-One, and click **Launch Utility**.  
The **HP Printer Utility** window appears.
5. In the **Configuration Settings** list, click **Supply Info**.  
The print cartridge reorder numbers appear.
6. If you want to order print cartridges, click **Supplies Status** in the **Configuration Settings** area, and then click **Order HP Supplies**.

**Order other supplies**

To order other supplies, such as HP All-in-One software, a copy of the User Guide, a Setup Guide, or other customer-replaceable parts, call the phone number for your country/region.

Country/region	Number for ordering
Asia Pacific (except for Japan)	65 272 5300
Australia	1300 721 147
Europe	+49 180 5 290220 (Germany) +44 870 606 9081 (U.K.)
New Zealand	0800 441 147
South Africa	+27 (0)11 8061030
U.S. and Canada	1-800-HP-INVENT (1-800-474-6836)

To order supplies in other countries/regions not listed in the table, go to [www.hp.com/support](http://www.hp.com/support). If prompted, choose your country/region, and then click **Contact HP** for information on calling for technical support.

# 10 Troubleshooting information

This chapter contains troubleshooting information for the HP All-in-One. Specific information is provided for installation and configuration issues, and some operational topics. For more troubleshooting information, see the onscreen Help that came with your software.

Many issues are caused when the HP All-in-One is connected to the computer using a USB cable before the HP All-in-One software is installed on the computer. If you connected the HP All-in-One to your computer before the software installation screen prompts you to do so, you must follow these steps:

## Troubleshooting common setup issues

1. Disconnect the USB cable from the computer.
2. Uninstall the software (if you have already installed it).
3. Restart your computer.
4. Turn off the HP All-in-One, wait one minute, then restart it.
5. Reinstall the HP All-in-One software.



**Caution** Do not connect the USB cable to the computer until prompted by the software installation screen.

For information about uninstalling and reinstalling the software, see [Uninstall and reinstall the software](#).

See the list below for information on other topics covered in this chapter.

## Additional troubleshooting topics in this User Guide

- **Setup troubleshooting:** Contains troubleshooting information on hardware setup and software installation.
- **Operational troubleshooting:** Contains information on issues that might occur during normal tasks when using the HP All-in-One features.

Additional sources of information are also available for helping you troubleshoot issues you might have with the HP All-in-One or HP Photosmart Software. See [Find more information](#).

If you are unable to solve the problem using the onscreen Help or HP websites, call HP Support using the number for your country/region. For more information, see [HP warranty and support](#).

## View the Readme file

You might want to refer to the Readme file for information on system requirements and possible installation problems.

- From a Windows computer, you can access the Readme file by clicking **Start**, pointing to **Programs** or **All Programs**, pointing to **HP**, pointing to **Deskjet All-in-One F300 series**, and then clicking **Readme**.
- From a Mac, you can access the Readme file by double-clicking the icon located in the top-level folder of the HP All-in-One software CD-ROM.



## Setup troubleshooting

This section includes installation and configuration troubleshooting tips for some of the most common issues associated with hardware and software setup.

### Hardware setup troubleshooting

Use this section to solve any problems you might encounter while setting up the HP All-in-One hardware.

#### The HP All-in-One will not turn on

**Cause** The HP All-in-One is not properly connected to a power supply.

#### Solution

- Make sure the power cord is firmly connected to both the HP All-in-One and the power adaptor. Plug the power cord into a grounded power outlet, surge protector, or power strip.

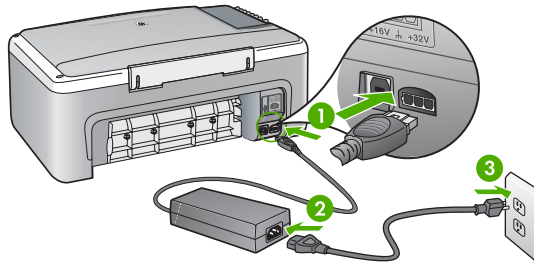

- |   |                        |
|---|------------------------|
| 1 | Power connection       |
| 2 | Power cord and adaptor |
| 3 | Grounded power outlet  |

- If you are using a power strip, make sure the power strip is on. Or, try plugging the HP All-in-One directly into a grounded power outlet.
- Test the power outlet to make sure it is working. Plug in an appliance that you know works, and see if the appliance has power. If not, then there might be a problem with the power outlet.
- If you plugged the HP All-in-One into a switched outlet, make sure the switch is on. If it is switched to on but still does not work, then there might be a problem with the power outlet.

**Cause** You pressed the **On** button too quickly.

**Solution** The HP All-in-One might not respond if you press the **On** button too quickly. Press the **On** button once. It might take a few minutes for the HP All-in-One to turn on. If you press the **On** button again during this time, you might turn the device off.



**Warning** If the HP All-in-One still does not turn on, it might have a mechanical failure. Unplug the HP All-in-One from the power outlet and contact HP. Go to:

If prompted, choose your country/region, and then click **Contact HP** for information on calling for technical support.

---

### I connected the USB cable, but I am having problems using the HP All-in-One with my computer

**Solution** You must first install the software that came with the HP All-in-One before connecting the USB cable. During installation, do not plug in the USB cable until prompted by the onscreen instructions. Connecting the USB cable before prompted can cause errors.

Once you have installed the software, connecting your computer to the HP All-in-One with a USB cable is straightforward. Simply plug one end of the USB cable into the back of your computer and the other into the back of the HP All-in-One. You can connect to any USB port on the back of your computer.

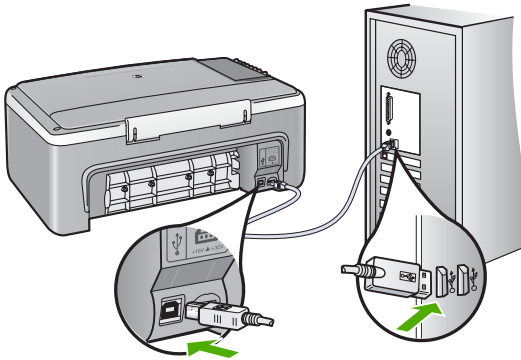

For more information on installing the software and connecting the USB cable, see the Setup Guide that came with the HP All-in-One.

---

### The HP All-in-One does not print

**Solution**

- Look at the **On** light located on the front of the HP All-in-One. If it is not lit, the HP All-in-One is turned off. Make sure the power cord is firmly connected to the HP All-in-One and plugged into a power outlet. Press the **On** button to turn on the HP All-in-One.
- Make sure the print cartridges are installed.
- Make sure you have paper loaded in the input tray.
- Check that the HP All-in-One does not have a paper jam.
- Check that the print carriage is not jammed.

Open the print cartridge door to access the print carriage area. Remove any objects that are blocking the print carriage, including any packing materials. Turn the HP All-in-One off and then turn it on again.

- Check that the HP All-in-One print queue is not paused (Windows) or stopped (Mac). If it is, choose the appropriate setting to resume printing. For more information about accessing the print queue, see the documentation that came with the operating system installed on your computer.
- Check the USB cable. If you are using an older cable, it might not be working properly. Try connecting it to another product to see if the USB cable works. If you experience problems, the USB cable might need to be replaced. Also verify that the cable does not exceed 3 meters (9.8 feet) in length.
- Make sure your computer is USB ready. Some operating systems, such as Windows 95 and Windows NT, do not support USB connections. Check the documentation that came with your operating system for more information.
- Check the connection from the HP All-in-One to your computer. Verify that the USB cable is securely plugged into the USB port on the back of the HP All-in-One. Make sure the other end of the USB cable is plugged into a USB port on your computer. After the cable is connected properly, turn the HP All-in-One off and then on again.

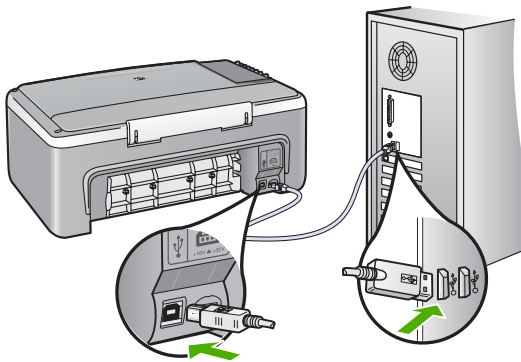

- If you are connecting the HP All-in-One through a USB hub, make sure the hub is turned on. If the hub is on, try connecting directly to your computer.
- Check other printers or scanners. You might need to disconnect older products from your computer.
- Try connecting the USB cable to another USB port on your computer. After you check the connections, try restarting your computer. Turn the HP All-in-One off and then on again.
- After you check the connections, try restarting your computer. Turn the HP All-in-One off and then on again.
- If necessary, remove and then install the software you installed with the HP All-in-One again. For more information, see [Uninstall and reinstall the software](#).

For more information on setting up the HP All-in-One and connecting it to your computer, see the Setup Guide that came with the HP All-in-One.

If the HP All-in-One and computer are not communicating with each other, try the following:

---

## Software installation troubleshooting

If you encounter a problem during software installation, see the topics below for a possible solution. If you encounter a hardware problem during setup, see [Hardware setup troubleshooting](#).

During a normal installation of the HP All-in-One software, the following events occur:

1. The HP All-in-One software CD-ROM runs automatically.
2. The software installs.
3. Files are copied to your computer.
4. You are requested to connect the HP All-in-One to your computer.
5. A green OK and check mark appear on an installation wizard screen.
6. You are requested to restart your computer.
7. The registration process runs.

If any of these things did not occur, there might be a problem with the installation.

To check the installation on a Windows computer, verify the following:

- Start the **HP Solution Center** and check to make sure the following buttons appear: **Scan Picture** and **Scan Document**. If the icons do not appear immediately, you might need to wait a few minutes for the HP All-in-One to connect to your computer. Otherwise, see [Some of the buttons are missing in the HP Solution Center \(Windows\)](#).
- Open the **Printers** dialog box and check to see that the HP All-in-One is listed.
- Look in the system tray at the far right of the Windows taskbar for an HP All-in-One icon. This indicates that the HP All-in-One is ready.

### When I insert the CD-ROM into my computer's CD-ROM drive, nothing happens

**Solution** If the installation does not run automatically, you can start it manually.

#### To start the installation from a Windows computer

1. From the Windows **Start** menu, click **Run**.
2. In the **Run** dialog box, enter **d:\setup.exe**, and then click **OK**.  
If your CD-ROM drive is not assigned to drive letter D, enter the appropriate drive letter.

#### To start the installation from a Mac

1. Double-click the CD icon on your desktop to view the contents of the CD.
  2. Double-click the installation icon.
-

### The minimum system checks screen appears (Windows)

**Solution** Your system does not meet the minimum requirements to install the software. Click **Details** to see what the specific problem is, and then correct the problem before attempting to install the software.

You can also try installing HP Photosmart Essential instead. HP Photosmart Essential provides less functionality than the HP Photosmart Premier software, but it requires less space and memory on your computer.

For more information about installing the HP Photosmart Essential software, see the Setup Guide that came with the HP All-in-One.

### A red X appears on the USB connect prompt

**Solution** Normally, a green check appears indicating that the plug and play is successful. A red X indicates that the plug and play failed.

1. Verify that the control panel overlay is firmly attached, unplug the HP All-in-One power cord, and then plug it in again.
2. Verify that the USB cable and power cord are plugged in.

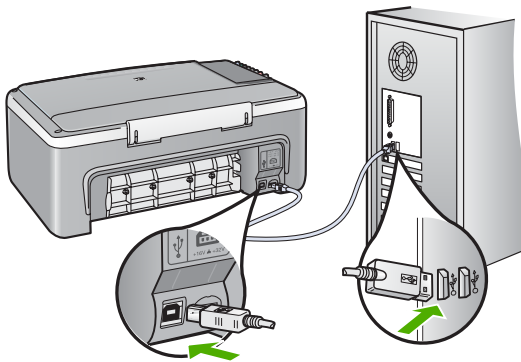

3. Click **Retry** to retry the plug and play setup. If this does not work, continue to the next step.
4. Verify that the USB cable is set up properly as follows:
  - Unplug the USB cable and plug it in again.
  - Do not attach the USB cable to a keyboard or non-powered hub.
  - Verify that the USB cable is 3 meters (9.8 feet) or less in length.
  - If you have several USB devices attached to your computer, you might want to unplug the other devices during the installation.
5. Continue with the installation and restart the computer when prompted.
6. If you are using a Windows computer, open the **HP Solution Center** and check for the essential icons (**Scan Picture** and **Scan Document**). If the essential icons do not appear, remove the software and then reinstall it. For more information, see [Uninstall and reinstall the software](#).

### I received a message that an unknown error has occurred

**Solution** Try to continue with the installation. If that does not work, stop and then restart the installation, and follow the directions on the screen. If an error occurs, you might need to uninstall and then reinstall the software. Do not simply delete the HP All-in-One application files from your computer. Make sure to remove them properly using the uninstall utility provided when you installed the software that came with the HP All-in-One.

For more information, see [Uninstall and reinstall the software](#).

---

### Some of the buttons are missing in the HP Solution Center (Windows)

If the essential icons (**Scan Picture** and **Scan Document**) do not appear, your installation might not be complete.

**Solution** If your installation is incomplete, you might need to uninstall and then reinstall the software. Do not simply delete the HP All-in-One application files from your hard drive. Make sure to remove them properly using the uninstall utility provided in the HP All-in-One program group. For more information, see [Uninstall and reinstall the software](#).

---

### The registration screen does not appear (Windows)

**Solution** You can access the registration (Sign up now) screen from the Windows taskbar by clicking **Start**, pointing to **Programs** or **All Programs**, **HP**, **Deskjet All-In-One F300 series**, and then clicking **Product Registration**.

---

### The HP Digital Imaging Monitor does not appear in the system tray (Windows)

**Solution** If the **HP Digital Imaging Monitor** does not appear in the system tray (normally located at the lower-right corner of the desktop), start the **HP Solution Center** to check whether or not the essential icons are there.

For more information about missing essential buttons in the **HP Solution Center**, see [Some of the buttons are missing in the HP Solution Center \(Windows\)](#).

---

### Uninstall and reinstall the software

If your installation is incomplete, or if you connected the USB cable to the computer before prompted by the software installation screen, you might need to uninstall and then reinstall the software. Do not simply delete the HP All-in-One application files from your computer. Make sure to remove them properly using the uninstall utility provided when you installed the software that came with the HP All-in-One.

A reinstall can take from 20 to 40 minutes. There are three methods to uninstall the software on a Windows computer, and one method to uninstall on a Mac.

**To uninstall from a Windows computer, method 1**

1. Disconnect the HP All-in-One from your computer. Do not connect the HP All-in-One to your computer until after you have reinstalled the software.
2. Press the **On** button to turn off the HP All-in-One.
3. On the Windows taskbar, click **Start, Programs** or **All Programs, HP, Deskjet All-In-One F300 series, Uninstall**.
4. Follow the onscreen instructions.
5. If you are asked whether you would like to remove shared files, click **No**. Other programs that use these files might not work properly if the files are deleted.
6. Restart your computer.



**Note** It is important that you disconnect the HP All-in-One before restarting your computer. Do not connect the HP All-in-One to your computer until after you have reinstalled the software.

7. To reinstall the software, insert the HP All-in-One CD-ROM into your computer's CD-ROM drive, and follow the onscreen instructions and the instructions provided in the Setup Guide that came with the HP All-in-One.
8. After the software is installed, connect the HP All-in-One to your computer.
9. Press the **On** button to turn the HP All-in-One on.  
After connecting and turning on the HP All-in-One, you might have to wait several minutes for all of the Plug and Play events to complete.
10. Follow the onscreen instructions.

When the software installation is complete, the **HP Digital Imaging Monitor** icon appears in the Windows system tray.

To verify that the software is properly installed, double-click the **HP Solution Center** icon on the desktop. If the **HP Solution Center** shows the essential icons (**Scan Picture** and **Scan Document**), the software has been properly installed.

**To uninstall from a Windows computer, method 2**

**Note** Use this method if **Uninstall** is not available in the Windows Start menu.

1. On the Windows taskbar, click **Start, Settings, Control Panel**.
2. Double-click **Add/Remove Programs**.
3. Select **HP PSC & Officejet 6.0**, and then click **Change/Remove**.  
Follow the onscreen instructions.
4. Disconnect the HP All-in-One from your computer.
5. Restart your computer.



**Note** It is important that you disconnect the HP All-in-One before restarting your computer. Do not connect the HP All-in-One to your computer until after you have reinstalled the software.

6. Insert the HP All-in-One CD-ROM into your computer's CD-ROM drive and then start the Setup program.
7. Follow the onscreen instructions and the instructions provided in the Setup Guide that came with the HP All-in-One.

### To uninstall from a Windows computer, method 3



**Note** Use this method if **Uninstall** is not available in the Windows Start menu.

1. Insert the HP All-in-One CD-ROM into your computer's CD-ROM drive and then start the Setup program.
2. Select **Uninstall** and follow the onscreen directions.
3. Disconnect the HP All-in-One from your computer.
4. Restart your computer.



**Note** It is important that you disconnect the HP All-in-One before restarting your computer. Do not connect the HP All-in-One to your computer until after you have reinstalled the software.

5. Start the Setup program for the HP All-in-One again.
6. Select **Reinstall**.
7. Follow the onscreen instructions and the instructions provided in the Setup Guide that came with the HP All-in-One.

### To uninstall from a Mac

1. Disconnect the HP All-in-One from your Mac.
2. Double-click the **Applications:Hewlett-Packard** folder.
3. Double-click **HP Uninstaller**.  
Follow the onscreen instructions.
4. After the software is uninstalled, disconnect the HP All-in-One, and then restart your computer.



**Note** It is important that you disconnect the HP All-in-One before restarting your computer. Do not connect the HP All-in-One to your computer until after you have reinstalled the software.

5. To reinstall the software, insert the HP All-in-One CD-ROM into your computer's CD-ROM drive.
6. On the desktop, open the CD-ROM and then double-click **HP All-in-One Installer**.
7. Follow the onscreen instructions and the instructions provided in the Setup Guide that came with the HP All-in-One.

## Operational troubleshooting

This section contains information on paper and print cartridge troubleshooting.

If you have Internet access, you can get help from the HP website at [www.hp.com/support](http://www.hp.com/support). The website also provides answers to frequently asked questions.

### Paper troubleshooting

To help avoid paper jams, only use paper types that are recommended for the HP All-in-One. For a list of recommended papers go to [www.hp.com/support](http://www.hp.com/support).

Do not load curled or wrinkled paper, or paper with bent or torn edges, into the input tray.



If paper does become jammed in your device, follow these instructions to clear the paper jam.

### Clear paper jams

If the HP All-in-One has a paper jam, first check the rear door.

If the jammed paper is not in the rear rollers, check the front door.

#### To clear a paper jam from the rear door

1. Press in the tab on the left side of the rear door to release the door. Remove the door by pulling it away from the HP All-in-One.

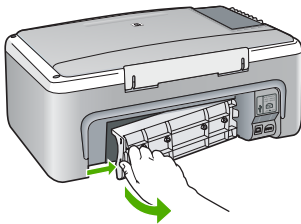

2. Gently pull the paper out of the rollers.



**Caution** If the paper tears when you are removing it from the rollers, check the rollers and wheels for torn pieces of paper that might be remaining inside the device. If you do not remove all the pieces of paper from the HP All-in-One, more paper jams are likely to occur.

3. Replace the rear door. Gently push the door forward until it snaps into place.
4. Press **Start Copy Black** to continue the current job.

#### To clear a paper jam from the front door

1. If necessary, pull the input tray down to open it. Then, lower the print cartridge door.

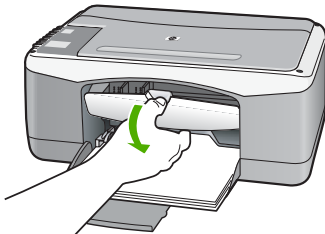

2. Gently pull the paper out of the rollers.



**Caution** If the paper tears when you are removing it from the rollers, check the rollers and wheels for torn pieces of paper that might be remaining inside the device. If you do not remove all the pieces of paper from the HP All-in-One, more paper jams are likely to occur.

3. Close the print cartridge door.



4. Press **Start Copy Black** to continue the current job.

## Print cartridge troubleshooting

If you are experiencing problems with printing, you might have a problem with one of the print cartridges.

### To troubleshoot print cartridges

1. Remove the black print cartridge from the slot on the right. Do not touch the ink nozzles or the copper-colored contacts. Check for possible damage to the copper-colored contacts or ink nozzles.  
Make sure the plastic tape has been removed. If it is still covering the ink nozzles, gently remove the plastic tape by using the pink pull tab.
2. Reinsert the print cartridge by sliding it forward into the slot. Then push the print cartridge forward until it clicks into the socket.

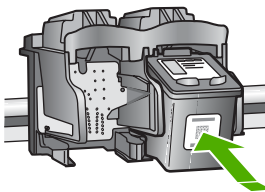

3. Repeat steps 1 and 2 for the tri-color print cartridge on the left side.
4. If the problem persists, print a self-test report to determine if there is a problem with the print cartridges.  
This report provides useful information about your print cartridges, including status information.
5. If the self-test report shows a problem, clean the print cartridges.
6. If the problem persists, clean the copper-colored contacts of the print cartridges.
7. If you are still experiencing problems with printing, determine which print cartridge is experiencing the problem and replace it.

For more information, see:

- [Replace the print cartridges](#)
- [Print a self-test report](#)
- [Clean the print cartridges](#)
- [Clean the print cartridge contacts](#)



# 11 HP warranty and support

This chapter provides warranty information as well as how to get support from the Internet, access your serial number and service ID, contact HP customer support, and prepare the HP All-in-One for shipment.

If you are unable to find the answer you need in the printed or onscreen documentation supplied with your product, you can contact one of the HP support services listed in the following section. Some support services are available only in the U.S. and Canada, while others are available in many countries/regions worldwide. If a support service number is not listed for your country/region, contact your nearest authorized HP dealer for help.

## Warranty

To obtain HP repair service, you must first contact an HP service office or an HP Customer Support Center for basic troubleshooting. See [Before you call HP customer support](#) for steps to take before calling Customer Support.

### Warranty upgrades

Depending on your country/region, HP might offer (for an additional fee) a warranty upgrade option that extends or enhances your standard product warranty. Available options might include priority phone support, return service, or next business day exchange. Typically, service coverage begins on product purchase date and must be purchased within a limited time of product purchase.

For more information, see:

- In the U.S., dial 1-866-234-1377 to speak to an HP advisor.
- Outside the U.S., please call your local HP Customer Support office. See [Call elsewhere in the world](#) for a list of international Customer Support numbers.
- Go to the HP website at [www.hp.com/support](http://www.hp.com/support). If prompted, choose your country/region, and then find warranty information.

## Warranty information

HP product	Duration of limited warranty
Software	90 days
Print cartridges	Until the HP ink is depleted or the "end of warranty" date printed on the cartridge has been reached, whichever occurs first. This warranty does not cover HP ink products that have been refilled, remanufactured, refurbished, misused, or tampered with.
Accessories	1 year
Printer peripheral hardware (see the following for details)	1 year

### A. Extent of limited warranty

1. Hewlett-Packard (HP) warrants to the end-user customer that the HP products specified above will be free from defects in materials and workmanship for the duration specified above, which duration begins on the date of purchase by the customer.
2. For software products, HP's limited warranty applies only to a failure to execute programming instructions. HP does not warrant that the operation of any product will be uninterrupted or error free.
3. HP's limited warranty covers only those defects that arise as a result of normal use of the product, and does not cover any other problems, including those that arise as a result of:
  - a. Improper maintenance or modification;
  - b. Software, media, parts, or supplies not provided or supported by HP;
  - c. Operation outside the product's specifications;
  - d. Unauthorized modification or misuse.
4. For HP printer products, the use of a non-HP ink cartridge or a refilled ink cartridge does not affect either the warranty to the customer or any HP support contract with the customer. However, if printer failure or damage is attributable to the use of a non-HP or refilled ink cartridge, HP will charge its standard time and materials charges to service the printer for the particular failure or damage.
5. If HP receives, during the applicable warranty period, notice of a defect in any product which is covered by HP's warranty, HP shall either repair or replace the product, at HP's option.
6. If HP is unable to repair or replace, as applicable, a defective product which is covered by HP's warranty, HP shall, within a reasonable time after being notified of the defect, refund the purchase price for the product.
7. HP shall have no obligation to repair, replace, or refund until the customer returns the defective product to HP.
8. Any replacement product may be either new or like-new, provided that it has functionality at least equal to that of the product being replaced.
9. HP products may contain remanufactured parts, components, or materials equivalent to new in performance.
10. HP's Limited Warranty Statement is valid in any country where the covered HP product is distributed by HP. Contracts for additional warranty services, such as on-site service, may be available from any authorized HP service facility in countries where the product is distributed by HP or by an authorized importer.

### B. Limitations of warranty

TO THE EXTENT ALLOWED BY LOCAL LAW, NEITHER HP NOR ITS THIRD PARTY SUPPLIERS MAKES ANY OTHER WARRANTY OR CONDITION OF ANY KIND, WHETHER EXPRESS OR IMPLIED WARRANTIES OR CONDITIONS OF MERCHANTABILITY, SATISFACTORY QUALITY, AND FITNESS FOR A PARTICULAR PURPOSE.

### C. Limitations of liability

1. To the extent allowed by local law, the remedies provided in this Warranty Statement are the customer's sole and exclusive remedies.
2. TO THE EXTENT ALLOWED BY LOCAL LAW, EXCEPT FOR THE OBLIGATIONS SPECIFICALLY SET FORTH IN THIS WARRANTY STATEMENT, IN NO EVENT SHALL HP OR ITS THIRD PARTY SUPPLIERS BE LIABLE FOR DIRECT, INDIRECT, SPECIAL, INCIDENTAL, OR CONSEQUENTIAL DAMAGES, WHETHER BASED ON CONTRACT, TORT, OR ANY OTHER LEGAL THEORY AND WHETHER ADVISED OF THE POSSIBILITY OF SUCH DAMAGES.

### D. Local law

1. This Warranty Statement gives the customer specific legal rights. The customer may also have other rights which vary from state to state in the United States, from province to province in Canada, and from country to country elsewhere in the world.
2. To the extent that this Warranty Statement is inconsistent with local law, this Warranty Statement shall be deemed modified to be consistent with such local law. Under such local law, certain disclaimers and limitations of this Warranty Statement may not apply to the customer. For example, some states in the United States, as well as some governments outside the United States (including provinces in Canada), may:
  - a. Preclude the disclaimers and limitations in this Warranty Statement from limiting the statutory rights of a consumer (e.g., the United Kingdom);
  - b. Otherwise restrict the ability of a manufacturer to enforce such disclaimers or limitations; or
  - c. Grant the customer additional warranty rights, specify the duration of implied warranties which the manufacturer cannot disclaim, or allow limitations on the duration of implied warranties.
3. THE TERMS IN THIS WARRANTY STATEMENT, EXCEPT TO THE EXTENT LAWFULLY PERMITTED, DO NOT EXCLUDE, RESTRICT, OR MODIFY, AND ARE IN ADDITION TO, THE MANDATORY STATUTORY RIGHTS APPLICABLE TO THE SALE OF THE HP PRODUCTS TO SUCH CUSTOMERS.

#### HP Limited Warranty

Dear Customer,

You will find below the name and address of the HP entity responsible for the performance of the HP Limited Warranty in your country.

**You may have additional statutory rights against the seller based on your purchase agreement. Those rights are not in any way affected by this HP Limited Warranty.**

**Ireland:** Hewlett-Packard Ireland Ltd. 30 Herbert Street IRL-Dublin 2

**United Kingdom:** Hewlett-Packard Ltd, Cain Road, Bracknell, GB-Berks RG12 1HN

## Get support and other information from the Internet

To find support and warranty information, go to the HP website at [www.hp.com/support](http://www.hp.com/support). If prompted, choose your country/region, and then click **Contact HP** for information on calling for technical support.

This website also offers technical support, drivers, supplies, ordering information and other options such as:

- Access online support pages.
- Send HP an e-mail message for answers to your questions.
- Connect with an HP technician by using online chat.
- Check for software updates.

Support options and availability vary by product, country/region, and language.

## Before you call HP customer support

Software programs from other companies might be included with the HP All-in-One. If you experience problems with any of those programs, you will receive the best technical assistance by calling the experts at that company.

**If you need to contact HP Customer Support, do the following before you call:**

1. Make sure that:
  - a. The HP All-in-One is plugged in and turned on.
  - b. The specified print cartridges are installed correctly.
  - c. The recommended paper is properly loaded in the input tray.
2. Reset the HP All-in-One:
  - a. Turn off the HP All-in-One by pressing the **On** button.
  - b. Unplug the power cord from the back of the HP All-in-One.
  - c. Plug the power cord back into the HP All-in-One.
  - d. Turn on the HP All-in-One by pressing the **On** button.
3. To find support and warranty information, go to the HP website at [www.hp.com/support](http://www.hp.com/support). If prompted, choose your country/region, and then click **Contact HP** for information on calling for technical support.  
Check the HP website for updated information or troubleshooting tips for the HP All-in-One .
4. If you are still experiencing problems and need to speak with an HP Customer Support Representative, do the following:
  - a. Have the specific name of the HP All-in-One, as it appears on the control panel, available.
  - b. Print a self-test report.
  - c. Make a color copy to have available as a sample printout.
  - d. Be prepared to describe your problem in detail.
  - e. Have your serial number and service ID ready.
5. Call HP Customer Support. Be near the HP All-in-One when you call.

For more information, see:

- [Print a self-test report](#)
- [Access your serial number and service ID](#)

## Access your serial number and service ID

You can access the serial number and service ID for the HP All-in-One by printing a self-test report.



**Note** If the HP All-in-One is not turning on, you can view the serial number by looking at the sticker on the rear side. The serial number is the 10-character code in the upper left corner of the sticker.

### To print a self-test report

1. Press and hold **Cancel** on the control panel.
2. While holding **Cancel**, press **Start Copy Color**.

The self-test report prints, containing the serial number and service ID.

## Call in North America during warranty

Call **1-800-474-6836 (1-800-HP invent)**. U.S. phone support is available in both English and Spanish languages 24 hours a day, 7 days a week (days and hours of support may change without notice). This service is free during the warranty period. A fee may apply outside the warranty period.

## Call elsewhere in the world

The numbers listed below are current as of the publication date of this guide. For a list of current international HP Support Service numbers, go to [www.hp.com/support](http://www.hp.com/support) and choose your own country/region or language.

Support service is free during the warranty period; however, your standard long-distance phone charges will apply. In some cases, additional fees might also apply.

For phone support in Europe, please check for the details and conditions of phone support in your country/region by going to [www.hp.com/support](http://www.hp.com/support).

Alternatively, you can ask your dealer or call HP at the phone number provided in this guide.

As part of our constant efforts to improve our phone support service, we advise you to check our website on a regular basis for new information regarding service features and delivery.



021 672 280	الجزائر
Argentina (Buenos Aires)	54-11-4708-1600
Argentina	0-800-555-5000
Australia	www.hp.com/support/australia
Österreich	www.hp.com/support
17212049	البحرين
België	www.hp.com/support
Belgique	www.hp.com/support
Brasil (Sao Paulo)	55-11-4004-7751
Brasil	0-800-709-7751
Canada (Mississauga Area)	(905) 206-4663
Canada	1-800-474-6836
Central America & The Caribbean	www.hp.com/support
Chile	800-360-999
中国	www.hp.com/support/china
Colombia (Bogotá)	571-606-9191
Colombia	01-8000-51-4746-8368
Costa Rica	0-800-011-1046
Česká republika	810 222 222
Danmark	www.hp.com/support
Ecuador (Andinatel)	1-999-119 800-711-2884
Ecuador (Pacifitel)	1-800-225-528 800-711-2884
(02) 6910602	مصر
El Salvador	800-6160
España	www.hp.com/support
France	www.hp.com/support
Deutschland	www.hp.com/support
Ελλάδα (από το εξωτερικό)	+ 30 210 6073603
Ελλάδα (εντός Ελλάδας)	801 11 75400
Ελλάδα (από Κύπρο)	800 9 2654
Guatemala	1-800-711-2884
香港特別行政區	www.hp.com/support/hongkong
Magyarország	06 40 200 629
India	www.hp.com/support/india
Indonesia	www.hp.com/support
+971 4 224 9189	العراق
+971 4 224 9189	الكويت
+971 4 224 9189	لبنان
+971 4 224 9189	قطر
+971 4 224 9189	اليمن
Ireland	www.hp.com/support
1-700-503-048	ישראל
Italia	www.hp.com/support
Jamaica	1-800-711-2884

日本	www.hp.com/support/Japan
0800 222 47	الأردن
한국	www.hp.com/support/korea
Luxembourg	www.hp.com/support
Malaysia	www.hp.com/support
Mauritius	(262) 262 210 404
México (Ciudad de México)	55-5258-9922
México	01-800-472-68368
081 005 010	المغرب
Nederland	www.hp.com/support
New Zealand	www.hp.com/support
Nigeria	1 3204 999
Norge	www.hp.com/support
24791773	عمان
Panamá	1-800-711-2884
Paraguay	009 800 54 1 0006
Perú	0-800-10111
Philippines	www.hp.com/support
Polska	22 5666 000
Portugal	www.hp.com/support
Puerto Rico	1-877-232-0589
República Dominicana	1-800-711-2884
Reunion	0820 890 323
România	0801 033 390
Россия (Москва)	095 777 3284
Россия (Санкт-Петербург)	812 332 4240
800 897 1415	السعودية
Singapore	www.hp.com/support/singapore
Slovensko	0850 111 256
South Africa (international)	+ 27 11 2589301
South Africa (RSA)	086 0001030
Rest of West Africa	+ 351 213 17 63 80
Suomi	www.hp.com/support
Sverige	www.hp.com/support
Switzerland	www.hp.com/support
臺灣	www.hp.com/support/taiwan
ไทย	www.hp.com/support
071 891 391	تونس
Trinidad & Tobago	1-800-711-2884
Türkiye	+90 212 444 71 71
Україна	(044) 230-51-06
600 54 47 47	الإمارات العربية المتحدة
United Kingdom	www.hp.com/support
United States	1-800-474-6836
Uruguay	0004-054-177
Venezuela (Caracas)	58-212-278-8666
Venezuela	0-800-474-68368
Việt Nam	www.hp.com/support



## Prepare the HP All-in-One for shipment

If after contacting HP Customer Support or returning to the point of purchase you are requested to send the HP All-in-One in for service, make sure you remove and keep the following items before returning your device:

- The print cartridges
- The power cord, USB cable, and any other cable connected to the HP All-in-One
- Any paper loaded in the input tray
- Any originals loaded in the HP All-in-One

### To remove print cartridges before shipment

1. Turn on the HP All-in-One and wait until the print carriage is idle and silent. If the HP All-in-One will not turn on, skip this step and go to step 2.
2. Open the print cartridge door.
3. Remove the print cartridges from their slots.



**Note** If the HP All-in-One does not turn on, you can unplug the power cord and then manually slide the print carriage to the center to remove the print cartridges.

4. Place the print cartridges in an airtight plastic container so they will not dry out, and put them aside. Do not send them with the HP All-in-One unless the HP customer support call agent instructs you to.
5. Close the print cartridge door and wait a few minutes for the print carriage to move back to its home position (on the left side).



**Note** Make sure the scanner is idle and has returned to its parked position before turning off the HP All-in-One.

6. Press the **On** button to turn off the HP All-in-One.

## Pack the HP All-in-One

Complete the following steps once you have removed the print cartridges, turned off the HP All-in-One, and unplugged it.

### To pack the HP All-in-One

1. If available, pack the HP All-in-One for shipment by using the original packing materials or the packaging materials that came with your exchange device.

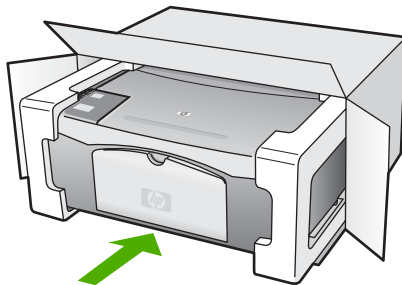

If you do not have the original packaging materials, please use other adequate packaging materials. Shipping damage caused by improper packaging and/or improper transportation is not covered under the warranty.

2. Place the return shipping label on the outside of the box.
3. Include the following items in the box:
  - A complete description of symptoms for service personnel (samples of print quality problems are helpful).
  - A copy of the sales slip or other proof of purchase to establish the warranty coverage period.
  - Your name, address, and a phone number where you can be reached during the day.



# 12 Technical information

The technical specifications and international regulatory information for the HP All-in-One are provided in this section.

## System requirements

Software system requirements are located in the Readme file.

## Paper specifications

This section contains information about paper tray capacities, paper sizes, and print margin specifications.

### Paper tray capacities

Type	Paper weight	Paper tray <sup>1</sup>	Output tray <sup>2</sup>
Plain paper	20 to 24 lb. (75 to 90 gsm)	100 (20 lb. paper)	50 (20 lb. paper)
Legal paper	20 to 24 lb. (75 to 90 gsm)	100 (20 lb. paper)	50 (20 lb. paper)
Cards	110 lb. index max (200 gsm)	20	10
Envelopes	20 to 24 lb. (75 to 90 gsm)	10	10
Transparency film	N/A	20	15 or fewer
Labels	N/A	20	10
4 x 6 inch (10 x 15 cm) Photo paper	145 lb. (236 gsm)	20	15
8.5 x 11 inch (216 x 279 mm) Photo paper	N/A	20	10

1 Maximum capacity.

2 Output tray capacity is affected by the type of paper and the amount of ink you are using. HP recommends emptying the output tray frequently.

### Paper sizes

Type	Size
Paper	Letter: 8.5 x 11 inches A4: 210 x 297 mm A5: 148 x 210 mm Executive: 7.25 x 10.5 inches Legal: 8.5 x 14 inches

Chapter 12  
(continued)

Type	Size
	JIS (B5): 182 x 257 mm
Envelopes	U.S. #10: 4.1 x 9.5 inches A2: 111 x 146 mm DL: 110 x 220 mm C6: 114 x 162 mm
Transparency film	Letter: 8.5 x 11 inches A4: 210 x 297 mm
Photo paper	4 x 6 inches 4 x 6 inches, with tear-off tab 5 x 7 inches Executive: 7.25 x 10.5 inches 8 x 10 inches 10 x 15 cm 10 x 15 cm, with tear-off tab 13 x 18 cm A6: 105 x 148.5 mm Hagaki: 100 x 148 mm
Cards	76 x 127 mm Index card: 101 x 152 mm 127 x 178 mm
Labels	Letter: 8.5 x 11 inches A4: 210 x 297 mm
Custom	76 x 127 mm up to 216 x 356 mm (3 x 5 inches up to 8.5 x 14 inches)

## Print margin specifications

	Top (leading edge)	Bottom (trailing edge) <sup>1</sup>	Left and right margins
Paper or transparency film			
U.S. (Letter, Legal, Executive)	1.8 mm (0.07 inches)	12.7 mm (0.5 inches)	6.4 mm (0.25 inches)
ISO (A4, A5) and JIS (B5)	1.8 mm (0.07 inches)	13.7 mm (0.54 inches)	3.3 mm (0.13 inches)
Envelopes			
	1.8 mm (0.07 inches)	13.5 mm (0.53 inches)	3.3 mm (0.13 inches)
Cards			
	1.8 mm (0.07 inches)	12.7 mm (0.5 inches)	3.3 mm (0.13 inches)

- 1 This margin is not compatible; however, the total writing area is compatible. The writing area is offset from center by 5.4 mm (0.21 inches), which causes asymmetric top and bottom margins.

## Print specifications

- 600 x 600 dpi black
- 4800 x 1200 optimized dpi color
- Method: drop-on-demand thermal inkjet
- Language: LIDIL (lightweight imaging device interface language)
- Duty cycle: 700 printed pages per month

Mode		Resolution (dpi)
Max DPI	Black	4800 x 1200 optimized DPI
	Color	4800 x 1200 optimized DPI <sup>1</sup>
Best	Black	1200 x 1200
	Color	1200 x 1200 up to 4800 dpi optimized <sup>2</sup>
Normal	Black	600 x 600
	Color	600 x 600
Fast Normal	Black	300 x 300
	Color	300 x 300
Fast Draft	Black	300 x 300
	Color	300 x 300

- 1 Up to 4800 x 1200 optimized dpi color printing on premium photo papers, 1200 x 1200 input dpi.
- 2 Up to 4800 x 1200 optimized dpi color printing on premium photo papers, 1200 x 1200 input dpi.

## Copy specifications

- Digital image processing
- Up to 9 copies from original (varies by model)
- Fit to page

Mode		Print resolution (dpi)	Scan resolution (dpi) <sup>1</sup>
Best	Black	600 x 600	600 x 2400
	Color	1200 x 1200 <sup>2</sup>	600 x 2400
Fast	Black	300 x 1200	600 x 1200
	Color	600 x 300	600 x 1200

- 1 Maximum at 400% scaling.
- 2 On photo paper or premium paper.

## Scan specifications

- Image editor included
- Integrated OCR software automatically converts scanned text to editable text
- Twain-compliant interface
- Resolution: up to 1200 x 2400 ppi optical; 19200 ppi enhanced (varies by model)
- Color: 48-bit color, 8-bit grayscale (256 levels of gray)
- Maximum scan size from glass: 21.6 x 29.7 cm (8.5 x 11.7 inches)

## Physical specifications

- Height: 16.97 cm (7.0 inches)
- Width: 44 cm (16.8 inches)
- Depth: 25.9 cm (10.2 inches)
- Weight: 4.5 kg (10 pounds)

## Power specifications

- Power consumption: 80 W maximum
- Input voltage: AC 100 to 240 V ~ 1 A 50–60 Hz, grounded
- Output voltage: DC 32 V===560 mA, 15 V or 16 V===530mA

## Environmental specifications

- Recommended operating temperature range: 15° to 32° C (59° to 90° F)
- Allowable operating temperature range: 5° to 35° C (41° to 95° F)
- Humidity: 15% to 80% RH non-condensing
- Non-operating (Storage) temperature range: –20° to 50° C (–4° to 122° F)
- In the presence of high electromagnetic fields, it is possible the output from the HP All-in-One may be slightly distorted
- HP recommends using a USB cable less than or equal to 3 m (10 feet) in length to minimize injected noise due to potential high electromagnetic fields

## Acoustic information

If you have Internet access, you can get acoustic information from the HP website. Go to: [www.hp.com/support](http://www.hp.com/support).

## Environmental product stewardship program

This section provides information on protecting the environment; ozone production; energy consumption; paper use; plastics; material safety data sheets; and recycling programs.

This section contains information about environmental standards.

### Protecting the environment

Hewlett-Packard is committed to providing quality products in an environmentally sound manner. This product has been designed with several attributes to minimize impacts on our environment.

For more information, visit HP's Commitment to the Environment website at:

[www.hp.com/hpinfo/globalcitizenship/environment/index.html](http://www.hp.com/hpinfo/globalcitizenship/environment/index.html)

### Ozone production

This product generates no appreciable ozone gas (O3).

### Energy consumption

Energy usage drops significantly while in ENERGY STAR® mode, which saves natural resources, and saves money without affecting the high performance of this product. This product and external power supply qualify for ENERGY STAR, which is a voluntary program established to encourage the development of energy-efficient office products.



ENERGY STAR is a U.S. registered service mark of the U.S. EPA. As an ENERGY STAR partner, HP has determined that this product meets ENERGY STAR guidelines for energy efficiency.

For more information on ENERGY STAR guidelines, go to the following website:

[www.energystar.gov](http://www.energystar.gov)

### Paper use

This product is suited for the use of recycled paper according to DIN 19309 and EN 12281:2002.

### Plastics

Plastic parts over 25 grams are marked according to international standards that enhance the ability to identify plastics for recycling purposes at the end of the product's life.

### Material safety data sheets

Material safety data sheets (MSDS) can be obtained from the HP website at:

[www.hp.com/go/msds](http://www.hp.com/go/msds)

Customers without Internet access should contact their local HP Customer Care Center.

### Hardware recycling program

HP offers an increasing number of product return and recycling programs in many countries/ regions, as well as partnering with some of the largest electronic recycling centers throughout the world. HP also conserves resources by refurbishing and reselling some of its most popular products.

For information regarding recycling of HP products, please visit: [www.hp.com/recycle](http://www.hp.com/recycle).



### HP inkjet supplies recycling program

HP is committed to protecting the environment. The HP Inkjet Supplies Recycling Program is available in many countries/regions, and lets you recycle used print cartridges and ink cartridges free of charge. For more information, go to the following website:

[www.hp.com/recycle](http://www.hp.com/recycle)

### Disposal of Waste Equipment by Users in Private Households in the European Union

This symbol on the product or on its packaging indicates that this product must not be disposed of with your other household waste. Instead, it is your responsibility to dispose of your waste equipment by handing it over to a designated collection point for the recycling of waste electrical and electronic equipment. The separate collection and recycling of your waste equipment at the time of disposal will help to conserve natural resources and ensure that it is recycled in a manner that protects human health and the environment. For more information about where you can drop off your waste equipment for recycling, please contact your local city office, your household waste disposal service, or the shop where you purchased the product.



## Regulatory notices

The HP All-in-One meets product requirements from regulatory agencies in your country/region.

### Regulatory model identification number

For regulatory identification purposes, your product is assigned a Regulatory Model Number. The Regulatory Model Number for your product is SDGOB-0601. This regulatory number should not be confused with the marketing name (HP Deskjet F300 All-in-One series).

### FCC statement

The United States Federal Communications Commission (in 47 CFR 15.105) has specified that the following notice be brought to the attention of users of this product.

Declaration of Conformity: This equipment has been tested and found to comply with the limits for a Class B digital device, pursuant to part 15 of the FCC Rules. Operation is subject to the following two conditions: (1) this device may not cause harmful interference, and (2) this device must accept any interference received, including interference that might cause undesired operation. Class B limits are designed to provide reasonable protection against harmful interference in a residential installation. This equipment generates, uses, and can radiate radio frequency energy, and, if not installed and used in accordance with the instructions, might cause harmful interference to radio communications. However, there is no guarantee that interference will not occur in a particular installation. If this equipment does cause harmful interference to radio or television reception, which can be determined by turning the equipment off and on, the user is encouraged to try to correct the interference by one or more of the following measures:

- Reorient the receiving antenna.
- Increase the separation between the equipment and the receiver.
- Connect the equipment into an outlet on a circuit different from that to which the receiver is connected.
- Consult the dealer or an experienced radio/TV technician for help.

For more information, contact the Product Regulations Manager, Hewlett-Packard Company, San Diego, (858) 655-4100.

The user may find the following booklet prepared by the Federal Communications Commission helpful: How to Identify and Resolve Radio-TV Interference Problems. This booklet is available from the U.S. Government Printing Office, Washington DC, 20402. Stock No. 004-000-00345-4.



**Caution** Pursuant to Part 15.21 of the FCC Rules, any changes or modifications to this equipment not expressly approved by the Hewlett-Packard Company might cause harmful interference and void the FCC authorization to operate this equipment.

#### **Note à l'attention des utilisateurs canadien/notice to users in Canada**

Le présent appareil numérique n'émet pas de bruit radioélectrique dépassant les limites applicables aux appareils numériques de la classe B prescrites dans le Règlement sur le brouillage radioélectrique édicté par le ministère des Communications du Canada.

This digital apparatus does not exceed the Class B limits for radio noise emissions from the digital apparatus set out in the Radio Interference Regulations of the Canadian Department of Communications.

#### **Notice to users in Australia**



This equipment complies with Australian EMC requirements.

#### **Notice to users in Korea**

### **사용자 안내문(B급 기기)**

이 기기는 비업무용으로 전자파 적합 등록을 받은 기기로서, 주거지역에서는 물론 모든 지역에서 사용할 수 있습니다.

#### **Declaration of conformity (European Economic Area)**

The Declaration of Conformity in this document complies with ISO/IEC Guide 22 and EN 45014. It identifies the product, manufacturer's name and address, and applicable specifications recognized in the European community.

## HP Deskjet F300 All-in-One series declaration of conformity



### DECLARATION OF CONFORMITY

according to ISO/IEC Guide 22 and EN 45014

Manufacturer's Name: Hewlett-Packard Company  
 Manufacturer's Address: 16399 West Bernardo Drive  
 San Diego CA 92127, USA  
 Regulatory Model Number: SDGOB-0601  
 Declares, that the product:  
 Product Name: HP Deskjet F300 All-in-One series  
 Power Adapters HP part#: 0957-2146, 0957-2119, 0957-2201

Conforms to the following Product Specifications:

Safety: IEC 60950-1: 2001  
 EN 60950-1: 2001  
 IEC 60825-1 Edition 1.2: 2001 / EN 60825-1+A11+A2+A1: 2002 Class 1(Laser/Led)  
 UL 60950-1: 2003, CAN/CSA-22.2 No. 60950-01-03  
 NOM 019-SFCI-1993, AS/NZS 60950: 2000, GB4943: 2001

EMC: CISPR 22:1993+A1:1995+A2:1996 / EN 55022:1994+A1:1995+A2:1997 Class B  
 CISPR 24:1997+A1+A2 / EN 55024:1998+A1:2001+A2:2003  
 IEC 61000-3-2: 2000 / EN 61000-3-2: 2000  
 IEC 61000-3-3/A1: 2001 / EN 61000-3-3/ A1: 2001  
 CNS13438:1998, VCCI-2  
 FCC Part 15-Class B/ICES-003, Issue 4  
 GB9254: 1998

Supplementary Information:

The product herewith complies with the requirements of the Low Voltage Directive 73/23/EC, the EMC Directive 89/336/EC and carries the CE-marking accordingly. The product was tested in a typical configuration.

This Device complies with Part 15 of the FCC Rules. Operation is subject to the following two Conditions:  
 (1) this device may not cause harmful interference, and (2) this device must accept any interference received, including interference that may cause undesired operation.

For regulatory purpose, this product is assigned a Regulatory Model Number (RMN). This number should not be confused with the product name or number.

San Diego, California USA  
 September 2005

**For Regulatory Topics only, contact:**

Australia Contact: Product Regulations Manager, Hewlett-Packard Australia Ltd., 31-41 Joseph Street, Blackburn, Victoria 3130, Australia  
 European Contact: Hewlett Packard GmbH, HQ-TRE, Herrenberger Strasse 140,D-71034 Böblingen Germany. (FAX +49-7031-14-3143)  
 USA Contact: Product Regulations Manager, Hewlett Packard Company, San Diego, (858) 655-4100

# Index

## Symbols/Numerics

- 10 x 15 cm photo paper
  - load 14
  - specifications 57
- 4 x 6 inch photo paper, load 14

## A

- A4 paper, load 13
- align print cartridges 30

## B

- buttons, control panel 4

## C

- cancel
  - copy 22
  - print job 20
  - scan 24
- cancel button 4
- cartridges. *See* print cartridges
- choose paper 11
- clean
  - exterior 25
  - glass 25
  - lid backing 26
  - print cartridge contacts 32
  - print cartridges 31
- connection problems
  - HP All-in-One does not turn on 38
- connection types supported
  - printer sharing 9
  - USB 9
- control panel
  - buttons 4,
- copy
  - cancel 22
  - make a copy 21
  - number of copies 21
  - paper types,
    - recommended 21
  - specifications 60
- customer support
  - contact 51
  - North America 52
  - outside U.S. 52

- serial number 51
- service ID 51
- warranty 49
- website 51

## D

- declaration of conformity
  - European Economic Area 63
  - United States 64
- documents
  - scan 23

## E

- envelopes
  - load 15
  - specifications 57
- environment
  - Environmental product stewardship program 61
  - environmental specifications 60
  - inkjet supplies recycling 62
- European Union
  - recycling information 62

## F

- FCC
  - statement 62

## G

- glass
  - clean 25
- greeting cards, load 16

## H

- help
  - other resources 7
- HP JetDirect 9
- HP Solution Center, missing icons 43

## I

- images
  - scan 23

- ink cartridges. *See* print cartridges
- install software, troubleshoot 37

## J

- jams, paper 17

## L

- labels
  - load 16
  - specifications 57
- legal paper
  - load 13
  - specifications 57
- letter paper
  - load 13
  - specifications 57
- lid backing, clean 26
- load
  - 10 x 15 cm photo paper 14
  - 4 x 6 inch photo paper 14
  - A4 paper 13
  - envelopes 15
  - full-size paper 13
  - greeting cards 16
  - iron-on transfers 16
  - labels 16
  - legal paper 13
  - letter paper 13
  - original 11
  - transparencies 16

## M

- maintenance
  - align print cartridges 30
  - clean exterior 25
  - clean glass 25
  - clean lid backing 26
  - clean print cartridges 31
  - print cartridges 27
  - replace print cartridges 28
  - self-test report 26
- make a copy 21
- media. *See* paper

## N

number of copies  
copy 21

## O

on button 4  
order  
paper 35  
print cartridges 35  
Setup Guide 36  
software 36  
User Guide 36

## P

paper  
choose 11  
incompatible types 12  
jams 17, 46  
load 13  
order 35  
paper sizes 57  
recommended copy types 21  
recommended types 12  
specifications 57  
troubleshoot 45  
paper tray capacities 57  
phone numbers, customer support 51  
photo paper  
load 14  
specifications 57  
photos 23  
physical specifications 60  
power specifications 60  
print  
cancel job 20  
from computer 19  
from software application 19  
self-test report 26  
specifications 59  
print cartridges  
align 30  
clean 31  
clean contacts 32  
handle 27  
order 35  
part names 27  
replace 28  
troubleshoot 47  
print margin specifications 59

printer sharing  
Mac 9

## R

Readme file 37  
recycle  
HP All-in-One 62  
print cartridges 62  
regulatory notices  
declaration of conformity (European Economic Area) 63  
declaration of conformity (U.S.) 64  
FCC statement 62  
note à l'attention des utilisateurs Canadien 63  
notice to users in Canada 63  
notice to users in Korea 63  
regulatory model  
identification number 62  
WEEE 62  
reinstall software 43  
replace print cartridges 28  
reports  
self-test 26  
resources, help 7

## S

scan  
cancel 24  
documents 23  
features 23  
photos 23  
scan specifications 60  
stop 24  
scan button 5  
scan glass  
clean 25  
self-test report 26  
serial number 51  
service ID 51  
ship your device 54  
software application, print from 19  
software installation  
reinstall 43  
troubleshoot 41  
uninstall 43  
specifications. See technical information

start copy  
black 5  
color 5  
status lights  
overview 5  
stop  
copy 22  
print job 20  
scan 24  
system requirements 57

## T

technical information  
copy specifications 60  
environmental  
specifications 60  
paper sizes 57  
paper specifications 57  
paper tray capacities 57  
physical specifications 60  
power specifications 60  
print margin  
specifications 59  
print specifications 59  
scan specifications 60  
system requirements 57  
weight 60  
telephone numbers, customer support 51  
transparencies  
load 16  
specifications 57  
troubleshoot  
hardware installation 38  
jams, paper 17  
operational tasks 45  
paper 45  
print cartridges 47  
Readme file 37  
resources 7  
setup 38  
software installation 41  
USB cable 39

## U

uninstall software 43  
USB cable installation 39  
USB port speed 9

## W

warranty 49