

# HP Deskjet F2100 All-in-One series

## Basics Guide

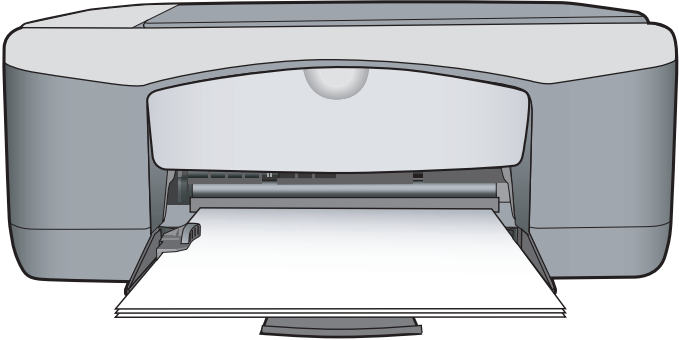
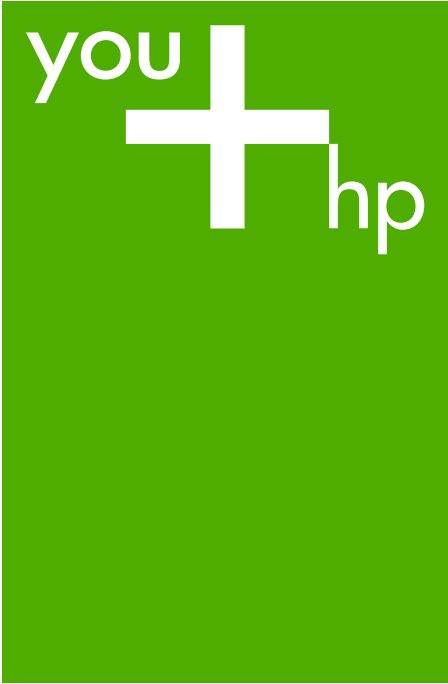

**Hewlett-Packard Company notices**

The information contained in this document is subject to change without notice.

All rights reserved. Reproduction, adaptation, or translation of this material is prohibited without prior written permission of Hewlett-Packard, except as allowed under copyright laws. The only warranties for HP products and services are set forth in the express warranty statements accompanying such products and services. Nothing herein should be construed as constituting an additional warranty. HP shall not be liable for technical or editorial errors or omissions contained herein.

© 2007 Hewlett-Packard Development Company, L.P.

Windows, Windows 2000, and Windows XP are U.S. registered trademarks of Microsoft Corporation.

Windows Vista is either a registered trademark or trademark of Microsoft Corporation in the United States and/or other countries.

Intel and Pentium are trademarks or registered trademarks of Intel Corporation or its subsidiaries in the United States and other countries.

# Contents

<b>1 HP All-in-One overview</b>	
The HP All-in-One at a glance.....	2
Control panel buttons.....	3
Status light overview.....	4
Load originals for scanning and copying.....	5
Make a copy.....	5
Scan an original.....	6
<b>2 Troubleshooting and support</b>	
Uninstall and reinstall the software.....	7
Hardware setup troubleshooting.....	8
Clear paper jams.....	10
Print cartridge troubleshooting.....	10
Find more information.....	10
Setup Guide.....	10
Onscreen Help.....	11
HP Web site.....	11
Ink usage.....	11
HP support.....	11
HP support by phone.....	11
Phone support period.....	11
After the phone support period.....	11
Before calling HP Support.....	11
<b>3 Technical information</b>	
System requirements.....	12
Paper specifications.....	12
Physical specifications.....	12
Power specifications.....	12
Environmental specifications.....	12
Regulatory notices.....	12
Regulatory model identification number.....	12
Warranty.....	13

# 1 HP All-in-One overview

The HP Deskjet F2100 All-in-One series is a versatile device that gives you easy-to-use copying, scanning, and printing. For information about the full range of features and functions, see the onscreen Help.

## The HP All-in-One at a glance

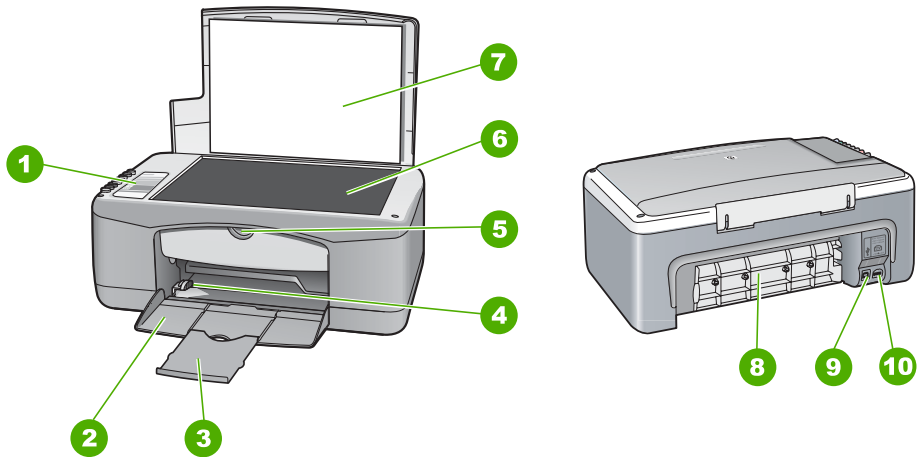

Label	Description
1	Control panel
2	Input tray
3	Tray extender
4	Paper-width guide
5	Print cartridge door
6	Glass
7	Lid backing
8	Rear door
9	Rear USB port
10	Power connection*

\* Use only with the power adapter supplied by HP.

# Control panel buttons

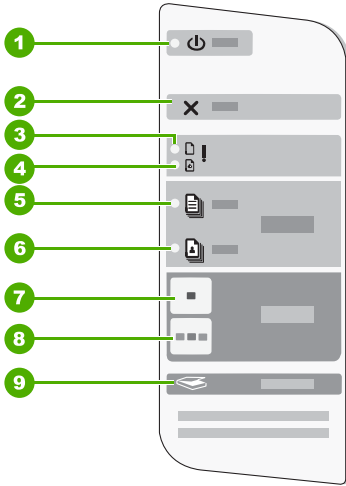

Label	Icon	Name and Description
1		<b>On:</b> Turns the HP All-in-One on or off. The <b>On</b> button is lit when the HP All-in-One is powered on.
2		<b>Cancel:</b> Stops a print, copy, or scan job.
3		<b>Check Paper light:</b> Indicates the need to load paper or remove a paper jam. The button next to this light is the Resume button. In certain situations (for example, after clearing a paper jam), this button resumes the job.
4		<b>Check Print Cartridge light:</b> Indicates the need to reinsert the print cartridge, replace the print cartridge, or close the print cartridge door. The button next to this light is the Resume button. In certain situations (for example, after clearing a paper jam), this button resumes the job.
5		<b>Plain Paper Type:</b> Changes the paper type setting to plain paper. This is the default setting for the HP All-in-One.
6		<b>Photo Paper Type:</b> Changes the paper type setting to photo paper. Make sure photo paper is loaded in the input tray.
7		<b>Start Copy Black:</b> Starts a black-and-white copy job.
8		<b>Start Copy Color:</b> Starts a color copy job.
9		<b>Scan:</b> Starts scanning the original currently on the glass. The Scan command functions only when the computer is on.

## Status light overview

Several indicator lights inform you of the status of the HP All-in-One.

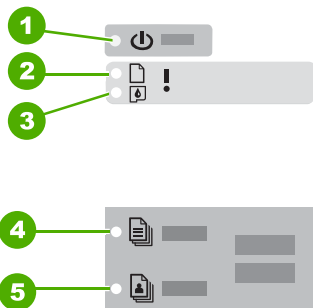

Label	Description
1	On button
2	Check Paper light
3	Check Print Cartridge light
4	Plain Paper Type light
5	Photo Paper Type light

The following table describes common situations and explains what the lights mean.

Light status	What it means
All lights are off.	The HP All-in-One is turned off. Press the <b>On</b> button to turn on the device.
The <b>On</b> light and one of the Paper Type lights are on.	The HP All-in-One is ready for printing, scanning, or copying.
The <b>On</b> light is blinking.	The HP All-in-One is busy printing, scanning, copying, or aligning the print cartridges.
The <b>On</b> light blinks quickly for 3 seconds and then is on steady.	You pressed a button while the HP All-in-One is already busy printing, scanning, copying, or aligning the print cartridges.
The <b>On</b> light blinks for 20 seconds and then is on steady.	You pressed the <b>Scan</b> button and there was no response from the computer.
The Check Paper light is blinking.	<ul style="list-style-type: none"> <li>The HP All-in-One is out of paper.</li> <li>The HP All-in-One has a paper jam.</li> <li>The paper size setting does not match the paper size detected in the input tray.</li> </ul>
The Check Print Cartridge light is blinking.	<ul style="list-style-type: none"> <li>The print cartridge door is open.</li> <li>The print cartridges are missing or not seated correctly.</li> <li>The tape was not removed from the print cartridge.</li> <li>The print cartridge is not intended for use in this HP All-in-One.</li> <li>The print cartridge might be defective.</li> </ul>

(continued)

Light status	What it means
	<b>NOTE:</b> Your printer might be packaged with only a tri-color print cartridge.
The <b>On</b> , Check Paper, and Check Print Cartridge lights are blinking.	Scanner failure. Turn off the HP All-in-One, then on again. If the problem persists, contact HP Support.
All lights are blinking.	The HP All-in-One has a fatal error. <ol style="list-style-type: none"><li>1. Turn the HP All-in-One off.</li><li>2. Unplug the power cord.</li><li>3. Wait a minute, then plug the power cord back in.</li><li>4. Turn the HP All-in-One back on.</li></ol> If the problem persists, contact HP Support.

## Load originals for scanning and copying

You can load many different types and sizes of paper in the HP All-in-One, including letter or A4 paper, photo paper, transparencies, and envelopes.

For information about loading full-size paper, see the Setup Guide. For information about loading other paper sizes, see the onscreen Help.

### To load an original on the glass

1. Lift the lid on the HP All-in-One.
2. Place your original with the side you want to copy or scan face down on the left front corner of the glass.

 **TIP:** To get the correct copy size, make sure that there is no tape or other foreign object on the glass.

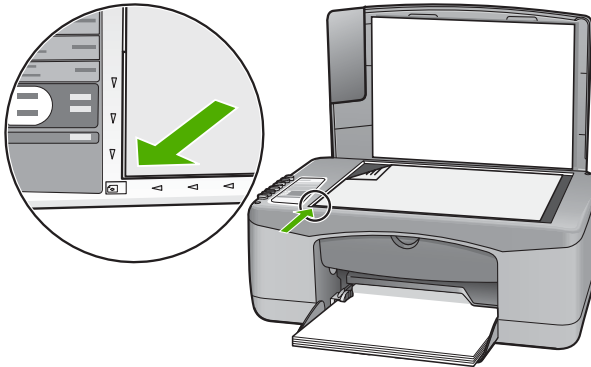

3. Close the lid.

## Make a copy

You can make quality copies from the control panel.

### To make a copy from the control panel

1. Make sure you have paper loaded in the input tray.
2. Place your original print side down on the left front corner of the glass.
3. Press **Start Copy Black** or **Start Copy Color**.

## Scan an original

For original documents or images placed on the glass, you can start a scan from your computer or from the HP All-in-One. To use the scan features, the HP All-in-One and computer must be connected and turned on. The HP Photosmart Software must also be installed and running on your computer prior to scanning.

### To scan to a computer

1. Place your original with the side you want to copy or scan face down on the left front corner of the glass.



**TIP:** For quality copies, ensure that the scanner glass is clean and that there are no foreign materials adhering to it.

---

2. Press **Scan**.  
If the original is a photo, a preview image of the scan appears on your computer, where you can edit it. Any edits that you make apply to the current scan session only.
3. Make any edits to the preview image, and then click **Accept** when you are finished.



## 2 Troubleshooting and support

This chapter contains troubleshooting information for installation and configuration issues and some operational topics. For more troubleshooting information, see the onscreen Help.

Many issues are caused when the HP All-in-One is connected to the computer using a USB cable before the HP All-in-One software is installed on the computer. If you connected the HP All-in-One to your computer before the software installation screen prompts you to do so, you must follow these steps:

### Troubleshooting common setup issues

1. Disconnect the USB cable from the computer.
2. Uninstall the software (if you have already installed it).
3. Restart your computer.
4. Turn off the HP All-in-One, wait one minute, then restart it.
5. Reinstall the HP All-in-One software.

---

 **CAUTION:** Do not connect the USB cable to the computer until prompted by the software installation screen.

---

For support contact information, see the inside back cover of this guide.

### Uninstall and reinstall the software

If your installation is incomplete, or if you connected the USB cable to the computer before prompted by the software installation screen, you might need to uninstall and then reinstall the software. Do not simply delete the HP All-in-One application files from your computer. Make sure to remove them properly using the uninstall utility provided when you installed the software that came with the HP All-in-One.

#### To uninstall from a Windows computer and then reinstall

1. On the Windows taskbar, click **Start**, and then click **Control Panel**.
2. Double-click **Add/Remove Programs**.
3. Select **HP Deskjet All-In-One Driver Software**, and then click **Change/Remove**.  
Follow the onscreen instructions.
4. Disconnect the HP All-in-One from your computer.
5. Restart your computer.

---

 **NOTE:** It is important that you disconnect the HP All-in-One before restarting your computer. Do not connect the HP All-in-One to your computer until after you have reinstalled the software.

---

6. Insert the HP All-in-One CD-ROM into your computer's CD-ROM drive and then start the Setup program.
7. Follow the onscreen instructions and the instructions provided in the Setup Guide that came with the HP All-in-One.

When the software installation is complete, the **HP Digital Imaging Monitor** icon appears in the Windows system tray.

To verify that the software is properly installed, double-click the HP Solution Center icon on the desktop. If the HP Solution Center shows the essential icons (**Scan Picture** and **Scan Document**), the software has been properly installed.

#### To uninstall from a Mac and then reinstall

1. Disconnect the HP All-in-One from your Mac.
2. Open the **Applications:Hewlett-Packard** folder.

3. Double-click **HP Uninstaller**.  
Follow the onscreen instructions.
4. After the software is uninstalled, disconnect the HP All-in-One, and then restart your computer.

 **NOTE:** It is important that you disconnect the HP All-in-One before restarting your computer. Do not connect the HP All-in-One to your computer until after you have reinstalled the software.

5. To reinstall the software, insert the HP All-in-One CD-ROM into your computer's CD-ROM drive.
6. On the desktop, open the CD-ROM and then double-click **HP All-in-One Installer**.
7. Follow the onscreen instructions and the instructions provided in the Setup Guide that came with the HP All-in-One.

## Hardware setup troubleshooting

This section contains hardware troubleshooting information for the HP All-in-One.

### The HP All-in-One will not turn on

**Cause:** The HP All-in-One is not properly connected to a power supply.

#### Solution

- Make sure the power cord is firmly connected to both the HP All-in-One and the power adapter. Plug the power cord into a power outlet, surge protector, or power strip.

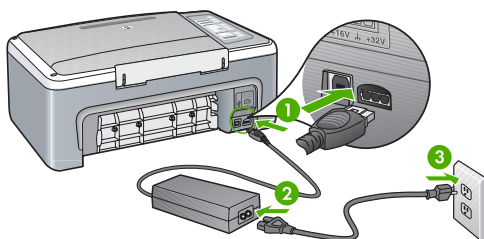

1	Power connection
2	Power cord and adapter
3	Power outlet

- If you are using a power strip, make sure the power strip is on. Or, try plugging the HP All-in-One directly into a power outlet.
- Test the power outlet to make sure it is working. Plug in an appliance that you know works, and see if the appliance has power. If not, then there might be a problem with the power outlet.
- If you plugged the HP All-in-One into a switched outlet, make sure the switch is on. If it is switched to on but still does not work, then there might be a problem with the power outlet.

**Cause:** You pressed the **On** button too quickly.

**Solution:** The HP All-in-One might not respond if you press the **On** button too quickly. Press the **On** button once. It might take a few seconds for the HP All-in-One to turn on. If you press the **On** button again during this time, you might turn the device off.

 **CAUTION:** If the HP All-in-One still does not turn on, it might have a mechanical failure. Unplug the HP All-in-One from the power outlet and contact HP. Go to: [www.hp.com/support](http://www.hp.com/support). If prompted, choose your country/region, and then click **Contact HP** for information on calling for technical support.

## I connected the USB cable, but I am having problems using the HP All-in-One with my computer

**Solution:** You must first install the software that came with the HP All-in-One before connecting the USB cable. During installation, do not plug in the USB cable until prompted by the onscreen instructions. Connecting the USB cable before prompted can cause errors. Once you have installed the software, connecting your computer to the HP All-in-One with a USB cable is straightforward. Simply plug one end of the USB cable into the back of your computer and the other into the back of the HP All-in-One. You can connect to any USB port on the back of your computer.

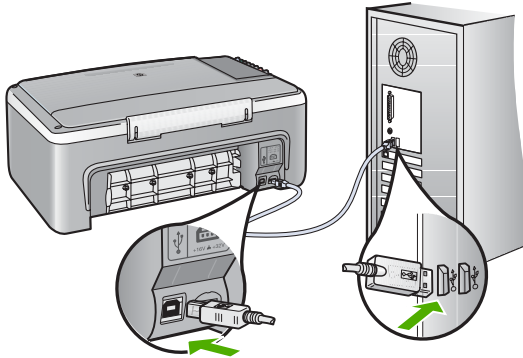

For more information on installing the software and connecting the USB cable, see the Setup Guide that came with the HP All-in-One.

## The HP All-in-One does not print

**Solution:** If the HP All-in-One and computer are not communicating with each other, try the following:

- Look at the **On** light located on the front of the HP All-in-One. If it is not lit, the HP All-in-One is turned off. Make sure the power cord is firmly connected to the HP All-in-One and plugged into a power outlet. Press the **On** button to turn on the HP All-in-One.
- Make sure the print cartridges are installed.
- Make sure you have paper loaded in the input tray.
- Check that the HP All-in-One does not have a paper jam.
- Check that the print carriage is not jammed. Open the print cartridge door to access the print carriage area. Remove any objects that are blocking the print carriage, including any packing materials. Turn the HP All-in-One off and then turn it on again.
- Check that the HP All-in-One print queue is not paused or offline (Windows) or stopped (Mac). If it is, choose the appropriate setting to resume printing. For more information about accessing the print queue, see the documentation that came with the operating system installed on your computer.
- Check the USB cable. If you are using an older cable, it might not be working properly. Try connecting it to another product to see if the USB cable works. If you experience problems, the USB cable might need to be replaced. Also verify that the cable does not exceed 3 meters (9.8 feet) in length.
- Check the connection from the HP All-in-One to your computer. Verify that the USB cable is securely plugged into the USB port on the back of the HP All-in-One. Make sure the other end of the USB cable is plugged into a USB port on your computer. After the cable is connected properly, turn the HP All-in-One off and then on again.

- If you are connecting the HP All-in-One through a USB hub, make sure the hub is turned on. If the hub is on, try connecting directly to your computer.
  - Check other printers or scanners. You might need to disconnect older products from your computer.
  - Try connecting the USB cable to another USB port on your computer. After you check the connections, try restarting your computer. Turn the HP All-in-One off and then on again.
  - If the HP All-in-One is offline, turn the HP All-in-One off and on again. Start a print job.
  - If necessary, remove and then install the software you installed with the HP All-in-One again.
- For more information on setting up the HP All-in-One and connecting it to your computer, see the Setup Guide that came with the HP All-in-One.

## Clear paper jams

For more information about clearing a paper jam, see the onscreen Help.

## Print cartridge troubleshooting

If you are experiencing problems with printing, you might have a problem with one of the print cartridges.

### To troubleshoot print cartridges

1. Remove the black print cartridge from the slot on the right. Do not touch the ink nozzles or the copper-colored contacts. Check for possible damage to the copper-colored contacts or ink nozzles.  
Make sure the plastic tape has been removed. If it is still covering the ink nozzles, gently remove the plastic tape by using the pink pull tab.
2. Reinsert the print cartridge by sliding it forward into the slot. Then push the print cartridge forward until it clicks into the socket.

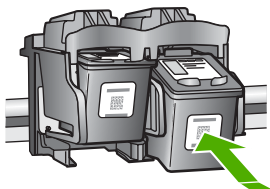

3. Repeat steps 1 and 2 for the tri-color print cartridge on the left side.
4. If the problem persists, you may need to print a self-test report or clean the print cartridges. For more information, see the onscreen Help.

## Find more information

A variety of resources, both printed and onscreen, provide information about setting up and using the HP All-in-One.

### Setup Guide

The Setup Guide provides instructions for setting up your HP All-in-One and installing software. Make sure you follow the steps in the Setup Guide in order.

If you have problems during setup, see Troubleshooting in the last section of the Setup Guide, or see [“Troubleshooting and support”](#) on page 7 in this guide.

## Onscreen Help

The onscreen Help provides detailed instructions on features of your HP All-in-One that are not described in this guide, including features that are only available using the software you installed with your HP All-in-One.

### To access the HP Photosmart Software Help on a Windows computer

1. In the HP Solution Center, click the tab for the HP All-in-One.
2. In the **Device Support** area, click **Onscreen Guide** or **Troubleshooting**.

## HP Web site

If you have Internet access, you can get help and support from the HP Web site at [www.hp.com/support](http://www.hp.com/support). This Web site offers technical support, drivers, supplies, and ordering information.

## Ink usage

Ink from the cartridges is used in the printing process in a number of different ways, including in the initialization process, which prepares the device and cartridges for printing, and in printhead servicing, which keeps print nozzles clear and ink flowing smoothly. In addition, some residual ink is left in the cartridge after it is used. For more information, see [www.hp.com/go/inkusage](http://www.hp.com/go/inkusage).

## HP support

You can contact HP Support by phone and online. Support options and availability vary by product, country/region, and language.

### HP support by phone

For a list of support phone numbers, see the inside front cover of this guide. Support options and availability vary by product, country/region, and language.

#### Phone support period

One year of phone support is available in Asia Pacific and Latin America (including Mexico). To determine the duration of phone support in North America, Eastern Europe, the Middle East, and Africa, go to [www.hp.com/support](http://www.hp.com/support).

Standard phone company charges apply.

#### After the phone support period

After the phone support period, help is available from HP at an additional cost.

Contact your HP dealer or call the support phone number for your country/region to learn more about support options.

### Before calling HP Support

1. Make sure that:
  - a. The HP All-in-One is plugged in and turned on.
  - b. The specified print cartridges are installed correctly.
  - c. The recommended paper is properly loaded in the input tray.
2. Reset the HP All-in-One:
  - a. Turn off the HP All-in-One by pressing the **On** button.
  - b. Unplug the power cord from the back of the HP All-in-One.
  - c. Plug the power cord back into the HP All-in-One.
  - d. Turn on the HP All-in-One by pressing the **On** button.
3. Have the following information available:
  - a. Specific name of the HP All-in-One, as it appears on the control panel.
  - b. Print a self-test report. (For more information, see the *User Guide*.)
  - c. Be prepared to describe your problem in detail.
  - d. Have your serial number and service ID ready, found on the self-test report.
  - e. Be near the HP All-in-One printer when you call HP Support.

# 3 Technical information

The technical specifications and international regulatory information for the HP All-in-One are provided in this section.

## System requirements

Software system requirements are located in the Readme file.

## Paper specifications

- Input tray capacity: Plain paper sheets: Up to 100 (20 lb. paper)
- Output tray capacity: Plain paper sheets: Up to 50 (20 lb. paper)

---

 **NOTE:** For a complete list of supported media sizes, see the printer software. For a complete list of paper weights, see the onscreen Help.

---

## Physical specifications

- Height: 16.97 cm (6.68 inches)
- Width: 42.57 cm (16.76 inches)
- Depth: 25.97 cm (10.22 inches)
- Weight: 4.045 kg (8.92 pounds)

## Power specifications

- Power consumption: 20 watts (average printing)
- Input voltage: AC 100 to 240 V ~ 1 A 50–60 Hz
- Output voltage: DC 32 V===375 mA, 16 V===500mA
- Power supply: 0957-2231, AC 100 to 240 V ~ 1 A 50–60 Hz

---

 **NOTE:** Use only with the power adapter supplied by HP.

---

## Environmental specifications

- Recommended operating temperature range: 15° to 30° C (59° to 86° F)
- Allowable operating temperature range: 10° to 35° C (50° to 95° F)
- Humidity: 15% to 80% RH non-condensing
- Non-operating (Storage) temperature range: –20° to 50° C (–4° to 122° F)
- In the presence of high electromagnetic fields, it is possible the output from the HP All-in-One may be slightly distorted
- HP recommends using a USB cable less than or equal to 3 m (10 feet) in length to minimize injected noise due to potential high electromagnetic fields

## Regulatory notices

The HP All-in-One meets product requirements from regulatory agencies in your country/region. For a complete listing of regulatory notices, see the onscreen Help.

### Regulatory model identification number

For regulatory identification purposes, your product is assigned a Regulatory Model Number. The Regulatory Model Number for your product is VCVRA-0706. This regulatory number should not be confused with the marketing name (HP Deskjet F2100 All-in-One series, etc.) or product numbers (CB595A, etc.).

# Warranty

HP product	Duration of limited warranty
Software Media	90 days
Printer	1 year
Print or Ink cartridges	Until the HP ink is depleted or the "end of warranty" date printed on the cartridge has been reached, whichever occurs first. This warranty does not cover HP ink products that have been refilled, remanufactured, refurbished, misused, or tampered with.
Accessories	1 year unless otherwise stated

## A. Extent of limited warranty

- Hewlett-Packard (HP) warrants to the end-user customer that the HP products specified above will be free from defects in materials and workmanship for the duration specified above, which duration begins on the date of purchase by the customer.
- For software products, HP's limited warranty applies only to a failure to execute programming instructions. HP does not warrant that the operation of any product will be interrupted or error free.
- HP's limited warranty covers only those defects that arise as a result of normal use of the product, and does not cover any other problems, including those that arise as a result of:
  - Improper maintenance or modification;
  - Software, media, parts, or supplies not provided or supported by HP;
  - Operation outside the product's specifications;
  - Unauthorized modification or misuse.
- For HP printer products, the use of a non-HP cartridge or a refilled cartridge does not affect either the warranty to the customer or any HP support contract with the customer. However, if printer failure or damage is attributable to the use of a non-HP or refilled cartridge or an expired ink cartridge, HP will charge its standard time and materials charges to service the printer for the particular failure or damage.
- If HP receives, during the applicable warranty period, notice of a defect in any product which is covered by HP's warranty, HP shall either repair or replace the product, at HP's option.
- If HP is unable to repair or replace, as applicable, a defective product which is covered by HP's warranty, HP shall, within a reasonable time after being notified of the defect, refund the purchase price for the product.
- HP shall have no obligation to repair, replace, or refund until the customer returns the defective product to HP.
- Any replacement product may be either new or like-new, provided that it has functionality at least equal to that of the product being replaced.
- HP products may contain remanufactured parts, components, or materials equivalent to new in performance.
- HP's Limited Warranty Statement is valid in any country where the covered HP product is distributed by HP. Contracts for additional warranty services, such as on-site service, may be available from any authorized HP service facility in countries where the product is distributed by HP or by an authorized importer.

## B. Limitations of warranty

TO THE EXTENT ALLOWED BY LOCAL LAW, NEITHER HP NOR ITS THIRD PARTY SUPPLIERS MAKES ANY OTHER WARRANTY OR CONDITION OF ANY KIND, WHETHER EXPRESS OR IMPLIED WARRANTIES OR CONDITIONS OF MERCHANTABILITY, SATISFACTORY QUALITY, AND FITNESS FOR A PARTICULAR PURPOSE.

## C. Limitations of liability

- To the extent allowed by local law, the remedies provided in this Warranty Statement are the customer's sole and exclusive remedies.
- TO THE EXTENT ALLOWED BY LOCAL LAW, EXCEPT FOR THE OBLIGATIONS SPECIFICALLY SET FORTH IN THIS WARRANTY STATEMENT, IN NO EVENT SHALL HP OR ITS THIRD PARTY SUPPLIERS BE LIABLE FOR DIRECT, INDIRECT, SPECIAL, INCIDENTAL, OR CONSEQUENTIAL DAMAGES, WHETHER BASED ON CONTRACT, TORT, OR ANY OTHER LEGAL THEORY AND WHETHER ADVISED OF THE POSSIBILITY OF SUCH DAMAGES.

## D. Local law

- This Warranty Statement gives the customer specific legal rights. The customer may also have other rights which vary from state to state in the United States, from province to province in Canada, and from country to country elsewhere in the world.
- To the extent that this Warranty Statement is inconsistent with local law, this Warranty Statement shall be deemed modified to be consistent with such local law. Under such local law, certain disclaimers and limitations of this Warranty Statement may not apply to the customer. For example, some states in the United States, as well as some governments outside the United States (including provinces in Canada), may:
  - Preclude the disclaimers and limitations in this Warranty Statement from limiting the statutory rights of a consumer (e.g., the United Kingdom);
  - Otherwise restrict the ability of a manufacturer to enforce such disclaimers or limitations; or
  - Grant the customer additional warranty rights, specify the duration of implied warranties which the manufacturer cannot disclaim, or allow limitations on the duration of implied warranties.
- THE TERMS IN THIS WARRANTY STATEMENT, EXCEPT TO THE EXTENT LAWFULLY PERMITTED, DO NOT EXCLUDE, RESTRICT, OR MODIFY, AND ARE IN ADDITION TO, THE MANDATORY STATUTORY RIGHTS APPLICABLE TO THE SALE OF THE HP PRODUCTS TO SUCH CUSTOMERS.

### HP Limited Warranty

Dear Customer,

You will find below the name and address of the HP entity responsible for the performance of the HP Limited Warranty in your country.

**You may have additional statutory rights against the seller based on your purchase agreement. Those rights are not in any way affected by this HP Limited Warranty.**

**Ireland:** Hewlett-Packard Ireland Ltd, 30 Herbert Street IRL-Dublin 2

**United Kingdom:** Hewlett-Packard Ltd, Cain Road, Bracknell, GB-Berks RG12 1HN







www.hp.com/support

Africa (English speaking)	+27 11 2345872	
Afrique (francophone)	+33 1 4993 9230	
	021 67 22 80	الجزائر
Argentina (Buenos Aires)	54-11-4708-1600	
Argentina	0-800-555-5000	
Australia	1300 721 147	
Australia (out-of-warranty)	1902 910 910	
Österreich	www.hp.com/support	
	17212049	البحرين
België	www.hp.com/support	
Belgique	www.hp.com/support	
Brasil (Sao Paulo)	55-11-4004-7751	
Brasil	0-800-709-7751	
Canada	1-(800)-474-6836 (1-800 hp invent)	
Central America & The Caribbean	www.hp.com/support	
Chile	800-360-999	
中国	10-68687980	
中国	800-810-3888	
Colombia (Bogotá)	571-606-9191	
Colombia	01-8000-51-4746-8368	
Costa Rica	0-800-011-1046	
Česká republika	810 222 222	
Danmark	www.hp.com/support	
Ecuador (Andinatel)	1-999-119 ☎ 800-711-2884	
Ecuador (Pacifitel)	1-800-225-528 ☎ 800-711-2884	
	(02) 6910602	مصر
El Salvador	800-6160	
España	www.hp.com/support	
France	www.hp.com/support	
Deutschland	www.hp.com/support	
Ελλάδα (από το εξωτερικό)	+ 30 210 6073603	
Ελλάδα (εντός Ελλάδας)	801 11 75400	
Ελλάδα (από Κύπρο)	800 9 2654	
Guatemala	1-800-711-2884	
香港特別行政區	(852) 2802 4098	
Magyarország	06 40 200 629	
India	1-800-425-7737	
India	91-80-28526900	
Indonesia	+62 (21) 350 3408	
	+971 4 224 9189	العراق
	+971 4 224 9189	الكويت
	+971 4 224 9189	البحرين
	+971 4 224 9189	قطر
	+971 4 224 9189	البحرين
Ireland	www.hp.com/support	
	1-700-503-048	ישראל
Italia	www.hp.com/support	

Jamaica	1-800-711-2884	
日本	0570-000-511	
日本(携帯電話の場合)	03-3335-9800	
	0800 222 47	الأردن
한국	1588-3003	
Luxembourg	www.hp.com/support	
Malaysia	1800 88 8588	
Mauritius	(262) 262 210 404	
México (Ciudad de México)	55-5258-9922	
México	01-800-472-68368	
	081 005 010	المغرب
Nederland	www.hp.com/support	
New Zealand	0800 441 147	
Nigeria	(01) 271 2320	
Norge	www.hp.com/support	
	24791773	لبنان
Panamá	1-800-711-2884	
Paraguay	009 800 54 1 0006	
Perú	0-800-10111	
Philippines	(2) 867 3551	
Philippines	1800 144 10094	
Polska	0801 800 235	
Portugal	www.hp.com/support	
Puerto Rico	1-877-232-0589	
República Dominicana	1-800-711-2884	
Reunion	0820 890 323	
România	0801 033 390	
Россия (Москва)	+7 495 7773284	
Россия (Санкт-Петербург)	+7 812 3324240	
	800 897 1415	السعودية
Singapore	6272 5300	
Slovensko	0850 111 256	
South Africa (RSA)	0860 104 771	
Suomi	www.hp.com/support	
Sverige	www.hp.com/support	
Switzerland	www.hp.com/support	
臺灣	(02) 8722 8000	
ไทย	+66 (2) 353 9000	
	071 891 391	تونس
Trinidad & Tobago	1-800-711-2884	
Türkiye	+90 (212)291 38 65	
Україна	(044) 230-51-06	
	600 54 47 47	الإمارات العربية المتحدة
United Kingdom	www.hp.com/support	
United States	1-(800)-474-6836 (1-800 hp invent)	
Uruguay	0004-054-177	
Venezuela (Caracas)	58-212-278-8666	
Venezuela	0-800-474-68368	
Việt Nam	+84 (8) 823 4530	