

HP Deskjet F4100 All-in-One series



Contents

1	HP Deskjet F4100 All-in-One series Help	5
2	HP All-in-One overview	
	The HP All-in-One at a glance	7
	Control panel buttons	8
	Status light overview	10
	Use the HP Photosmart software	11
3	Find more information	13
4	How do I?	15
5	Connection information	
	Supported connection types	17
	Use printer sharing	17
6	Load originals and load paper	
	Load originals	19
	Choose papers for printing and copying	19
	Recommended papers for printing and copying	20
	Recommended papers for printing only	21
	Papers to avoid	22
	Load paper	22
	Load full-size paper	23
	Load 10 x 15 cm (4 x 6 inch) photo paper	24
	Load index cards	25
	Load envelopes	26
	Load other types of paper	27
	Avoid paper jams	28
7	Print from your computer	
	Print from a software application	29
	Make the HP All-in-One the default printer	30
	Change the print settings for the current job	30
	Set the paper size	30
	Set the paper type for printing	31
	View the print resolution	32
	Change the print speed or quality	32
	Change the page orientation	32
	Scale the document size	33
	Change the saturation, brightness, or color tone	33
	Preview your print job	34
	Change the default print settings	34
	Printing shortcuts	34
	Create printing shortcuts	35

Perform special print jobs.....	36
Print a borderless image.....	36
Print a photo on photo paper.....	37
Create custom cd/dvd labels	38
Print using Maximum dpi	38
Print on both sides of the page.....	39
Print a multiple-page document as a booklet.....	40
Print multiple pages on a single sheet.....	42
Print a multiple-page document in reverse order.....	43
Reverse an image for iron-on transfers.....	44
Print on transparencies.....	44
Print a group of addresses on labels or envelopes.....	45
Print a poster.....	46
Print a Web page.....	47
Stop a print job.....	47
Resume a print job.....	48
8 Use the copy features	
Make a copy.....	49
Set the copy paper type.....	49
Change copy speed.....	50
Make multiple copies of the same original.....	51
Copy a two-page black-and-white document.....	52
Make a 10 x 15 cm (4 x 6 inch) borderless copy of a photo.....	53
Stop copying.....	53
9 Use the scan features	
Scan an original.....	55
Edit a scanned preview image.....	56
Edit a scanned image.....	56
Edit a scanned document.....	57
Stop scanning.....	57
10 Maintain the HP All-in-One	
Clean the HP All-in-One.....	59
Clean the exterior.....	59
Clean the glass.....	59
Clean the lid backing.....	60
Print a self-test report.....	60

Work with print cartridges.....	61
Handle the print cartridges.....	62
Check the estimated ink levels.....	62
Replace the print cartridges.....	63
Use ink-backup mode.....	67
Ink-backup mode output.....	67
Exit ink-backup mode.....	67
Use a photo print cartridge.....	67
Store the print cartridges.....	68
Print cartridge storage and handling.....	68
Print cartridge protector.....	68
Align the print cartridges.....	69
Clean the print cartridges.....	71
Clean the print cartridge contacts.....	71
Clean the area around the ink nozzles.....	72
Remove ink from your skin and clothing.....	74
11 Shop for printing supplies	
Order paper or other media.....	75
Order print cartridges.....	75
Order other supplies.....	76
12 Troubleshooting	
Troubleshooting tips.....	77
Communication problems over a USB connection.....	77
Information on paper.....	78
Clear paper jams.....	79
View the Readme file.....	79
Hardware setup troubleshooting.....	79
Software installation troubleshooting.....	83
Uninstall and reinstall the software.....	86
Print cartridge troubleshooting.....	88
Information on print cartridges.....	95
Print quality troubleshooting.....	95
Print troubleshooting.....	99
Copy troubleshooting.....	108
Scan troubleshooting.....	111
Errors.....	114
Flashing lights.....	114
Device messages.....	117
File messages.....	118
Supported file types for the HP All-in-One.....	119
General user messages.....	119
Paper messages.....	120
Power and connection messages.....	122
Print cartridge messages.....	124
13 HP warranty and support	
Warranty.....	129
Support process.....	129
Before you call HP customer support.....	129

HP support by phone.....	130
Phone support period.....	130
Placing a call.....	130
After the phone support period.....	130
Additional warranty options.....	131
Call HP Korea customer support.....	131
Prepare the HP All-in-One for shipment.....	131
Pack the HP All-in-One.....	131

14 Technical information

Specifications.....	133
Environmental product stewardship program.....	134
Paper use.....	134
Plastics.....	134
Material safety data sheets.....	134
Recycling program.....	135
HP inkjet supplies recycling program.....	135
Energy consumption.....	135
Disposal of Waste Equipment by Users in Private Households in the European Union.....	136
Regulatory notices.....	137
FCC statement.....	137
Notice to users in Australia.....	137
Notice to users in Korea.....	137
VCCI (Class B) compliance statement for users in Japan.....	138
Notice to users in Japan about power cord.....	138
Geräuschemission.....	138

1 HP Deskjet F4100 All-in-One series Help

For information about the HP All-in-One, see:

- [HP All-in-One overview](#)
- [Find more information](#)
- [How do I?](#)
- [Connection information](#)
- [Load originals and load paper](#)
- [Print from your computer](#)
- [Use the copy features](#)
- [Use the scan features](#)
- [Maintain the HP All-in-One](#)
- [Shop for printing supplies](#)
- [HP warranty and support](#)
- [Technical information](#)

2 HP All-in-One overview

The HP Deskjet F4100 All-in-One series is a versatile device that gives you easy-to-use copying, scanning, and printing.

Copy

The HP All-in-One allows you to produce high-quality color and black-and-white copies on a variety of paper types. You can enlarge or reduce the size of an original to fit a specific paper size, adjust the copy quality, and make high-quality copies of photos.

Scan

Scanning is the process of converting text and pictures into an electronic format for your computer. You can scan almost anything (photos, magazine articles, and text documents) on the HP All-in-One.

Print from your computer

The HP All-in-One can be used with any software application that allows printing. You can print a range of projects, such as borderless images, newsletters, greeting cards, iron-on transfers, and posters.

This section contains the following topics:

- [The HP All-in-One at a glance](#)
- [Control panel buttons](#)
- [Status light overview](#)
- [Use the HP Photosmart software](#)

The HP All-in-One at a glance

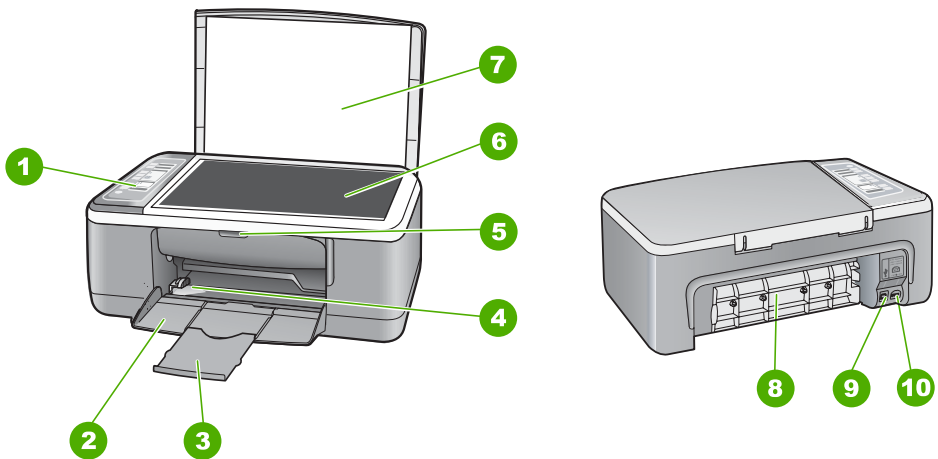

Label	Description
1	Control panel
2	Input tray
3	Tray extender
4	Paper-width guide
5	Print cartridge door
6	Glass
7	Lid backing
8	Rear door
9	Rear USB port
10	Power connection*





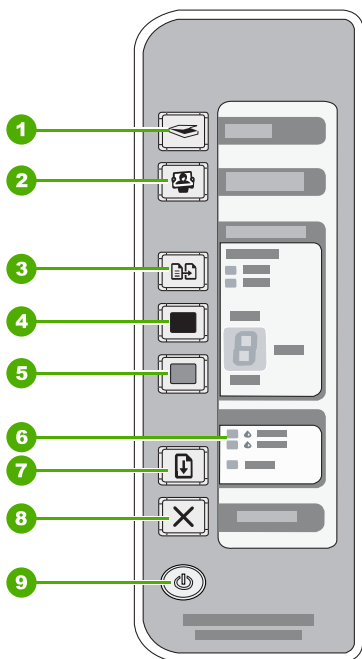

* Use only with the power adapter supplied by HP.

Control panel buttons



Label	Icon	Name and Description
1		On: Turns the HP All-in-One on or off. The On button is lit when the HP All-in-One is powered on. The light blinks while performing a job.

(continued)

Label	Icon	Name and Description
		<p>When the HP All-in-One is off, a minimal amount of power is still used by the device. To completely disconnect the power supply to the HP All-in-One, turn the device off, and then unplug the power cord.</p> <hr/> <p>CAUTION: Before you unplug the power cord, you must press the On button and allow the HP All-in-One to turn itself off. This prevents the print cartridges from drying out.</p>
2		<p>Cancel: Stops a print, copy, or scan job.</p>
3		<p>Resume: Instructs the HP All-in-One to continue after a problem is solved. A blinking Resume light next to the Resume button indicates the need to load paper or clear a paper jam.</p>
4		<p>Check Print Cartridge lights: Indicates the need to reinsert the specified print cartridge, replace the print cartridge, or close the print cartridge door. The Black/Photo light indicates that the problem is with the black or photo print cartridge, and the Color light indicates that the problem is with the tri-color print cartridge.</p>
5		<p>Start Copy Color: Starts a color copy job.</p> <p>Press this button multiple times to specify multiple color copies. The printer will start printing shortly after the number of copies have been selected. The number of copies to be printed is shown to the right of this button.</p> <hr/> <p>TIP: The maximum number of copies you can make using the control panel is 9. To make more copies at once, use the HP Software. When initiating multiple copies of an original from the software, only the last digit of the number of copies is represented on the control panel. For example, if you are making 25 copies, the number 5 appears on the display.</p>
6		<p>Start Copy Black: Starts a black-and-white copy job.</p> <p>Press this button multiple times to specify multiple black copies. The printer will start printing shortly after the number of copies have been selected. The number of copies to be printed is shown to the right of this button.</p> <hr/> <p>TIP: The maximum number of copies you can make using the control panel is 9. To make more copies at once, use the HP Software. When initiating multiple copies of an original from the software, only the last digit of the number of copies is represented on the control panel. For example, if you are making 25 copies, the number 5 appears on the display.</p>
7		<p>Paper Type: Changes the paper type setting to either plain or photo paper. Make sure the appropriate paper type is loaded in the input tray. The default paper type setting is Plain.</p> <p>The Paper Type lights indicate the currently selected paper type, Plain or Photo.</p>
8		<p>Photosmart Essential button: Launches the HP Photosmart Software for printing, editing, and sharing photos.</p> <hr/> <p>NOTE: If the HP Photosmart Software is not installed on your computer, the Photosmart Essential button will not do anything.</p>

Label	Icon	Name and Description
9		Scan: Starts scanning the original currently on the glass. The Scan command is ignored if the HP All-in-One is busy with any other job. The Scan command functions only when the computer is on.

Status light overview

Several indicator lights inform you of the status of the HP All-in-One.

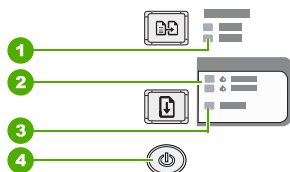

Label	Description
1	On button
2	Resume light
3	Check Print Cartridge lights
4	Paper Type lights (for the Paper Type button)

The following table describes common situations and explains what the lights mean.

Light status	What it means
All lights are off.	The HP All-in-One is turned off. Press the On button to turn on the device.
The On light and one of the Paper Type lights are on.	The HP All-in-One is ready for printing, scanning, or copying.
The On light is blinking.	The HP All-in-One is busy printing, scanning, copying, or aligning the print cartridges.
The On light blinks quickly for 3 seconds and then is on steady.	You pressed a button while the HP All-in-One is already busy printing, scanning, copying, or aligning the print cartridges.
The On light blinks for 20 seconds and then is steady.	You pressed the Scan button and there was no response from the computer.
The Resume light is blinking.	<ul style="list-style-type: none"> The HP All-in-One is out of paper. The HP All-in-One has a paper jam. The paper size setting in the copy software does not match the paper size detected in the input tray.
The Check Print Cartridge light is blinking.	<ul style="list-style-type: none"> The print cartridge door is open. The print cartridges are missing or not seated correctly. The tape was not removed from the print cartridge.

(continued)

Light status	What it means
	<ul style="list-style-type: none">• The print cartridge is not intended for use in this HP All-in-One.• The print cartridge might be defective.
The On , Resume , and Check Print Cartridge lights are blinking.	Scanner failure. Turn off the HP All-in-One, then turn it on again. If the problem persists, contact HP Support.
All lights are blinking.	The HP All-in-One has a fatal error. <ol style="list-style-type: none">1. Turn the HP All-in-One off.2. Unplug the power cord.3. Wait a minute, then plug the power cord back in.4. Turn the HP All-in-One back on. If the problem persists, contact HP Support.

Use the HP Photosmart software





The HP Photosmart Software provides a fast and easy way to make prints of your photos. It also provides access to other basic HP imaging software features, such as saving and viewing your photos.

For more information on using the HP Photosmart Software:

- Check the **Contents** panel on the left. Look for the **HP Photosmart Software Help contents** book at the top.
- If you do not see the **HP Photosmart Software Help contents** book at the top of the **Contents** panel, access the software help through the HP Solution Center.

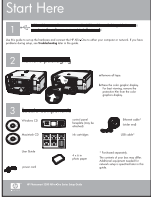
3 Find more information

You can access a variety of resources, both printed and onscreen, that provide information about setting up and using the HP All-in-One.

	<p>Setup Guide</p> <p>The Setup Guide provides instructions for setting up the HP All-in-One and installing software. Make sure you follow the steps in the Setup Guide in order. If you have problems during setup, check the Setup Guide for troubleshooting information, or see Troubleshooting in this onscreen Help.</p>
	<p>Basics Guide</p> <p>The Basics Guide contains an overview of the HP All-in-One, including step-by-step instructions for basic tasks, troubleshooting tips, and technical information.</p>
	<p>HP Photosmart Essential animations</p> <p>The HP Photosmart Essential animations are an interactive way to get a brief overview of the software included with the HP All-in-One. You will learn how the software can help you create, share, organize, and print your photos.</p>
	<p>Onscreen Help</p> <p>The onscreen Help provides detailed instructions on using all features of the HP All-in-One.</p> <ul style="list-style-type: none">• The How Do I? topic provides links so you can quickly find information on performing common tasks.• The The HP All-in-One overview topic provides general information about the main features of the HP All-in-One.• The Troubleshooting topic provides information about resolving errors you might encounter with the HP All-in-One.
	<p>Readme</p> <p>The Readme file contains the most recent information which might not be found in other publications.</p> <p>Install the software to access the Readme file.</p>
<p>www.hp.com/support</p>	<p>If you have Internet access, you can get help and support from the HP Web site. This Web site offers technical support, drivers, supplies, and ordering information.</p>

4 How do I?

This section contains links to commonly performed tasks, such as printing photos and optimizing your print jobs.

- [How do I change the print settings?](#)
- [How do I print borderless photos on 10 x 15 cm \(4 x 6 inch\) paper?](#)
- [How do I load envelopes?](#)
- [How do I scan using the control panel?](#)
- [How do I get the best print quality?](#)
- [How do I print on both sides of the paper?](#)
- [How do I replace the print cartridges?](#)
- [How do I align the print cartridges?](#)
- [How do I clear a paper jam?](#)

5 Connection information

The HP All-in-One comes equipped with a USB port so you can connect directly to a computer using a USB cable. You can also share the device over an existing home network.

This section contains the following topics:

- [Supported connection types](#)
- [Use printer sharing](#)

Supported connection types

The following table contains a list of supported connection types.

Description	Recommended number of connected computers for best performance	Supported software features	Setup instructions
USB connection	One computer connected with a USB cable to the rear USB 1.1 full speed peripheral connection port on the HP All-in-One.	All features are supported.	Follow the Setup Guide for detailed instructions.
Printer sharing	Five. The host computer must be on at all times in order to print from the other computers.	All features resident on the host computer are supported. Only printing is supported from the other computers.	Follow the instructions in Use printer sharing .

Use printer sharing

If your computer is on a network, and another computer on the network has an HP All-in-One connected to it by a USB cable, you can print to that printer using printer sharing.

The computer directly connected to the HP All-in-One acts as the **host** for the printer and has full software functionality. The other computer, which is referred to as a **client**, has access only to the print features. You must perform other functions from the host computer or from the control panel on the HP All-in-One.

To enable printer sharing on a Windows computer

- ▲ Refer to the user guide that came with your computer or see the Windows onscreen Help.

6 Load originals and load paper

You can load many different types and sizes of paper in the HP All-in-One, including letter or A4 paper, photo paper, transparencies, and envelopes.

This section contains the following topics:

- [Load originals](#)
- [Choose papers for printing and copying](#)
- [Load paper](#)
- [Avoid paper jams](#)

Load originals

You can copy or scan up to letter- or A4-size originals by loading them on the glass.



To load an original on the glass

1. Lift the lid on the HP All-in-One.
2. Place your original with the side you want to copy or scan face down on the left front corner of the glass.

 **TIP:** For more help on loading an original, refer to the engraved guides along the edge of the glass.

TIP: To get the correct copy size, make sure that there is no tape or other foreign object on the glass.

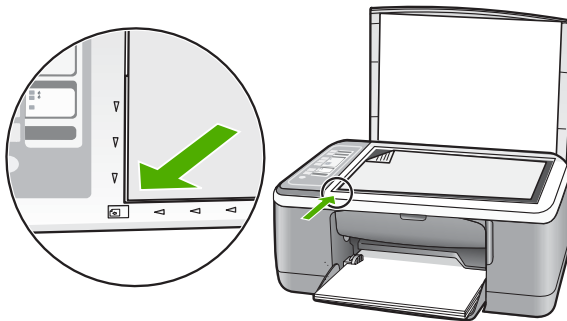

3. Close the lid.

Choose papers for printing and copying

You can use different types and sizes of paper in the HP All-in-One. Review the following recommendations to get the best printing and copying quality. Whenever you change paper types, remember to change the paper type settings. For more information, see [Set the paper type for printing](#).

This section contains the following topics:

- [Recommended papers for printing and copying](#)
- [Recommended papers for printing only](#)
- [Papers to avoid](#)

Recommended papers for printing and copying

If you want the best print quality, HP recommends using HP papers that are specifically designed for the type of project you are printing. If you are printing photos, for example, load HP Premium or HP Premium Plus photo paper in the input tray.

The following is a list of HP papers you can use for copying and printing. Depending on your country/region, some of these papers might not be available.

 **NOTE:** This device supports 10 x 15 cm (4 x 6 inch) with tab, A4-, letter-, and legal- (US only) size paper only.

NOTE: To achieve a borderless print, you must use 10 x 15 cm (4 x 6 inch) paper with tab. The HP All-in-One prints to the edge of three sides of the paper. When you remove the tab from the fourth side, you have a borderless print.

HP Premium Plus Photo Paper

HP Premium Plus Photo Papers are the best HP photo paper, with image quality and fade resistance superior to store-processed photos. They are ideal for printing your high-resolution images for framing or including in a photo album. These papers are available in several sizes, including 10 x 15 cm (4 x 6 inch) (with or without tabs), A4, and 8.5 x 11 inch sizes for printing or copying photos from the HP All-in-One.

HP Premium Photo Paper

HP Premium Photo Papers are high-quality, glossy-finish or soft gloss-finish photo papers. They look and feel like store-processed photos and can be mounted under glass or in an album. These papers are available in several sizes, including 10 x 15 cm (4 x 6 inch) (with or without tabs), A4, and 8.5 x 11 inch sizes for printing or copying photos from the HP All-in-One.

HP Premium Inkjet Transparency Film and HP Premium Plus Inkjet Transparency Film

HP Premium Inkjet Transparency Film and HP Premium Plus Inkjet Transparency Film make your color presentations vivid and even more impressive. This film is easy to use and handle and dries quickly without smudging.

HP Premium Inkjet Paper

HP Premium Inkjet Paper is the ultimate coated paper for high-resolution usage. A smooth, matte finish makes it ideal for your highest-quality documents.

HP Bright White Inkjet Paper

HP Bright White Inkjet Paper delivers high-contrast colors and sharp text. It is opaque enough for two-sided color usage with no show-through, which makes it ideal for newsletters, reports, and flyers.

HP All-in-One Paper or HP Printing Paper

Ensure that the Plain paper type is selected when using HP All-in-One Paper and HP Printing Paper.

- HP All-in-One Paper is specifically designed for HP All-in-One devices. It has an extra bright blue-white shade that produces sharper text and richer colors than ordinary multifunction papers.
- HP Printing Paper is a high-quality multifunction paper. It produces documents that look and feel more substantial than documents printed on standard multipurpose or copy paper.

To order HP papers and other supplies, go to www.hp.com/buy/supplies. If prompted, choose your country/region, follow the prompts to select your product, and then click one of the shopping links on the page.

 **NOTE:** At this time, some portions of the HP Web site are available in English only.

Recommended papers for printing only

Certain papers are supported only when you start the print job from your computer. The following list provides information about these papers.

If you want the best print quality, HP recommends using HP papers. Using paper that is too thin or too thick, paper that has a slick texture, or paper that stretches easily can cause paper jams. Using paper that has a heavy texture or does not accept ink can cause printed images to smear, bleed, or not fill in completely.

Depending on your country/region, some of these papers might not be available.

HP Iron-On Transfers

HP Iron-On Transfers (for color fabrics or for light or white fabrics) are the ideal solution for creating custom T-shirts from your digital photos.

HP Inkjet labels

Letter or A4 label sheets designed for use with HP inkjet products (like HP inkjet labels).

HP Brochure & Flyer Paper

HP Brochure & Flyer Paper (Gloss or Matte) is glossy-coated or matte-coated on both sides for two-sided use. They are the perfect choice for near-photographic reproductions and business graphics for report covers, special presentations, brochures, mailers, and calendars.

HP Premium Presentation Paper

HP Premium Presentation Paper gives your presentation a quality look and feel.

HP CD/DVD Tattoos

HP CD/DVD Tattoos allow you to personalize your CDs and DVDs by printing high-quality, low-cost CD or DVD labels.

To order HP papers and other supplies, go to www.hp.com/buy/supplies. If prompted, choose your country/region, follow the prompts to select your product, and then click one of the shopping links on the page.

 **NOTE:** At this time, some portions of the HP Web site are available in English only.

Papers to avoid

Using paper that is too thin or too thick, paper that has a slick texture, or paper that stretches easily can cause paper jams. Using paper that has a heavy texture or does not accept ink can cause printed images to smear, bleed, or not fill in completely.

 **NOTE:** For a complete list of supported media sizes, see the printer software.

Papers to avoid for all print and copy jobs

- Any size paper other than those listed in the technical specifications chapter of your printed documentation.
- Paper with cutouts or perforations (unless specifically designed for use with HP inkjet devices).
- Highly textured stock, such as linen. It might not print evenly, and the ink can bleed into these papers.
- Extremely smooth, shiny, or coated papers not specifically designed for the HP All-in-One. They can jam the HP All-in-One or repel the ink.
- Multi-part forms, such as duplicate and triplicate forms. They can wrinkle or get stuck, and the ink is more likely to smear.
- Envelopes with clasps or windows. They can get stuck in the rollers and cause paper jams.
- Banner paper.

Additional papers to avoid when copying

- Envelopes.
- Transparency film other than HP Premium Inkjet Transparency Film or HP Premium Plus Inkjet Transparency Film.
- Iron-On Transfers.
- Greeting card paper.

Load paper

This section describes the procedure for loading different types and sizes of paper into the HP All-in-One for your copies or printouts.

 **NOTE:** After a copy or print job has started, the paper width sensor can determine whether the paper is Letter, A4, or a smaller size.

 **TIP:** To help prevent rips, wrinkles, and curled or bent edges, store all paper flat in a resealable bag. If the paper is not stored properly, extreme changes in temperature and humidity might result in curled paper that does not work well in the HP All-in-One.

This section contains the following topics:

- [Load full-size paper](#)
- [Load 10 x 15 cm \(4 x 6 inch\) photo paper](#)

- [Load index cards](#)
- [Load envelopes](#)
- [Load other types of paper](#)

Load full-size paper

You can load many types of letter or A4 paper into the input tray of the HP All-in-One.



To load full-size paper

1. Flip the tray extender up toward you.

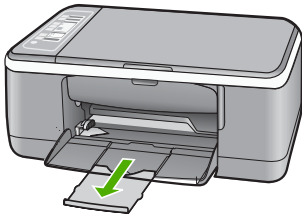

 **NOTE:** When you use legal-size paper, leave the tray extender closed.

2. Slide the paper-width guide to its outermost position.

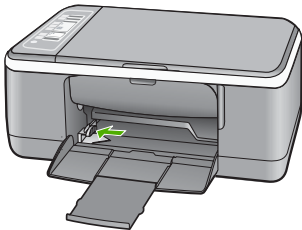

3. Tap a stack of paper on a flat surface to align the edges, and then check the paper for the following:
 - Make sure it is free of rips, dust, wrinkles, and curled or bent edges.
 - Make sure all the paper in the stack are the same size and type.

4. Insert the stack of paper into the input tray with the short edge forward. Ensure that the side you want to print on faces down. Slide the stack of paper toward the device until it stops.

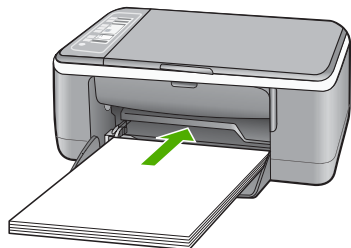

△ **CAUTION:** Make sure that the HP All-in-One is idle and silent when you load paper into the input tray. If the HP All-in-One is servicing the print cartridges or otherwise engaged in a task, the paper stop inside the device might not be in place. You could push the paper too far forward, causing the HP All-in-One to eject blank pages.

💡 **TIP:** If you are using letterhead, insert the top of the page first with the side you want to print on facing down. For more help on loading full-size paper and letterhead, refer to the diagram engraved in the base of the input tray.

5. Slide the paper-width guide inward until it stops at the edge of the paper. Do not overload the input tray; make sure the stack of paper fits within the input tray and is no higher than the top of the paper-width guide.

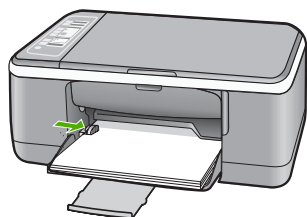

Load 10 x 15 cm (4 x 6 inch) photo paper

You can load 10 x 15 cm (4 x 6 inch) photo paper into the input tray of the HP All-in-One. For the best results, use 10 x 15 cm (4 x 6 inch) HP Premium Plus Photo Paper or HP Premium Photo Paper with tab.

📄 **NOTE:** For borderless printing, the HP All-in-One only supports 10 x 15 cm (4 x 6 inch) photo paper with a tear-off tab. You can automatically adjust the settings in the **Properties** dialog box to print a borderless 10 x 15 cm (4 x 6 inch) photo on HP Premium Plus Photo Paper. Click the **Printing Shortcuts** tab, and then, in the **Printing Shortcuts** list, select **Photo printing-borderless**.

 **TIP:** To help prevent rips, wrinkles, and curled or bent edges, store all paper flat in a resealable bag. If the paper is not stored properly, extreme changes in temperature and humidity might result in curled paper that does not work well in the HP All-in-One.

To load 10 x 15 cm (4 x 6 inch) photo paper with tab in the input tray

1. Remove all paper from the input tray.
2. Insert the stack of photo paper into the far-right side of the input tray with the short edge forward. Ensure that the side you want to print on faces down. Slide the stack of photo paper toward the device until it stops.
Load the photo paper so that the tabs are closest to you.

 **TIP:** For more help on loading small-size photo paper, refer to the guides engraved in the base of the input tray for loading photo paper.

3. Slide the paper-width guide inward until it stops at the edge of the paper.
Do not overload the input tray; make sure the stack of paper fits within the input tray and is no higher than the top of the paper-width guide.

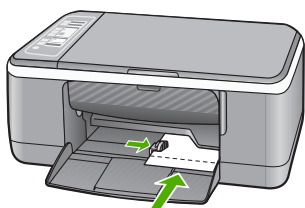

For best results, set the paper type before copying or printing.

Related topics

- [Recommended papers for printing and copying](#)
- [Change the print settings for the current job](#)
- [Set the copy paper type](#)

Load index cards

You can load index cards into the input tray of the HP All-in-One to print notes, recipes, and other text.

For best results, set the paper type before copying or printing.

 **NOTE:** The HP All-in-One leaves a 1.2 cm (.5 inch) border on one short edge. Before printing many cards, print one test card to make sure that the border does not crop your text.

To load index cards in the input tray

1. Remove all paper from the input tray.
2. Insert the stack of cards, with the side you want to print on facing down, into the far-right side of the input tray. Slide the stack of cards forward until it stops.
3. Slide the paper-width guide inward against the stack of cards until it stops.
Do not overload the input tray; make sure the stack of cards fits within the input tray and is no higher than the top of the paper-width guide.

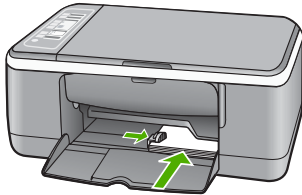

For best results, set the paper type before copying or printing.

Related topics

- [Load 10 x 15 cm \(4 x 6 inch\) photo paper](#)
- [Change the print settings for the current job](#)
- [Set the copy paper type](#)

Load envelopes

You can load one or more envelopes into the input tray of the HP All-in-One. Do not use shiny or embossed envelopes or envelopes that have clasps or windows.

 **NOTE:** For specific details on how to format text for printing on envelopes, consult the help files in your word processing software. For best results, consider using a label for the return address on envelopes.



To load envelopes

1. Remove all paper from the input tray.
2. Insert one or more envelopes into the far-right side of the input tray with the envelope flaps up and on the left. Slide the stack of envelopes forward until it stops.

 **TIP:** For more help on loading envelopes, refer to the diagram engraved in the base of the input tray.

3. Slide the paper-width guide inward against the stack of envelopes until it stops. Do not overload the input tray; make sure the stack of envelopes fits within the input tray and is not higher than the top of the paper-width guide.

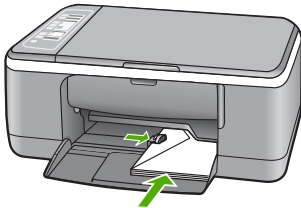

Load other types of paper

The following papers require extra attention to load them properly.

 **NOTE:** Not all paper sizes and paper types are available with all the functions on the HP All-in-One. Some paper sizes and paper types can only be used if you are starting a print job from the **Print** dialog box in a software application. They are not available for copying. Papers that are only available for printing from a software application are indicated as such.

HP Premium Inkjet Transparency Film and HP Premium Plus Inkjet Transparency Film

- ▲ Insert the film so that the white transparency strip (with arrows and the HP logo) is on top and is going into the input tray first.

 **NOTE:** The HP All-in-One cannot automatically detect the paper type. For best results, set the paper type to transparency film in the software before printing onto transparency film.

HP Iron-On Transfers (for printing only)

1. Flatten the transfer sheet completely before using it; do not load curled sheets.

 **TIP:** To prevent curling, keep transfer sheets sealed in the original package until you are ready to use them.

2. Locate the blue stripe on the nonprinting side of the transfer paper and then manually feed one sheet at a time into the input tray with the blue stripe facing up.

HP Inkjet labels (for printing only)

1. Always use letter or A4 label sheets designed for use with HP inkjet devices (such as HP inkjet labels), and make sure that the labels are no more than two years old. Labels on older sheets might peel off when the paper is pulled through the HP All-in-One, causing subsequent paper jams.
2. Fan the stack of labels to make sure none of the pages are sticking together.
3. Place a stack of label sheets on top of full-size plain paper in the input tray, label side down. Do not insert labels one sheet at a time.

For best results, set the paper type before copying or printing.

HP CD/DVD Tattoo labels (for printing only)

- ▲ Place one sheet of CD/DVD tattoo paper in the input tray with the print side down; slide the CD/DVD tattoo paper forward until it stops.



NOTE: When you use CD/DVD tattoo labels, leave the tray extender closed.

Related topics

- [Load 10 x 15 cm \(4 x 6 inch\) photo paper](#)
- [Set the paper type for printing](#)
- [Set the copy paper type](#)

Avoid paper jams

To help avoid paper jams, follow these guidelines.

- Remove printed papers from the output tray frequently.
- Prevent curled or wrinkled paper by storing all unused paper flat in a resealable bag.
- Ensure that paper loaded in the input tray lays flat and the edges are not bent or torn.
- Do not combine different paper types and paper sizes in the input tray; the entire stack of paper in the input tray must be the same size and type.
- Adjust the paper-width guide in the input tray to fit snugly against all paper. Make sure the paper-width guide does not bend the paper in the input tray.
- Do not force paper too far forward in the input tray.
- Use paper types that are recommended for the HP All-in-One.

Related topics

[Papers to avoid](#)

7 Print from your computer

The HP All-in-One can be used with any software application that allows printing. You can print a range of projects, such as borderless images, newsletters, greeting cards, iron-on transfers, and posters.

This section contains the following topics:

- [Print from a software application](#)
- [Make the HP All-in-One the default printer](#)
- [Change the print settings for the current job](#)
- [Change the default print settings](#)
- [Printing shortcuts](#)
- [Perform special print jobs](#)
- [Stop a print job](#)
- [Resume a print job](#)

Print from a software application

Most print settings are automatically handled by the software application. You need to change the settings manually only when you change print quality, print on specific types of paper or transparency film, or use special features.

To print from a software application

1. Make sure you have paper loaded in the input tray.
2. On the **File** menu in your software application, click **Print**.
3. Select the HP All-in-One as the printer.
If you set the HP All-in-One as the default printer, you can skip this step. The HP All-in-One will already be selected.
4. If you need to change settings, click the button that opens the **Properties** dialog box. Depending on your software application, this button might be called **Properties**, **Options**, **Printer Setup**, **Printer**, or **Preferences**.



NOTE: When printing a photo, you must select options for the correct paper type and photo enhancement.

5. Select the appropriate options for your print job by using the features available in the **Advanced**, **Printing Shortcuts**, **Features**, and **Color** tabs.

 TIP: You can easily select the appropriate options for your print job by choosing one of the predefined print tasks on the **Printing Shortcuts** tab. Click a type of print task in the **Printing Shortcuts** list. The default settings for that type of print task are set and summarized on the **Printing Shortcuts** tab. If necessary, you can adjust the settings here and save your custom settings as a new printing shortcut. To save a custom printing shortcut, select the shortcut and click **Save As**. To delete a shortcut, select the shortcut and click **Delete**.

6. Click **OK** to close the **Properties** dialog box.
7. Click **Print** or **OK** to begin printing.

Make the HP All-in-One the default printer

You can set the HP All-in-One as the default printer to use from all software applications. This means that the HP All-in-One is automatically selected in the printer list when you select **Print** from the **File** menu in a software application. The default printer is also printed to automatically when you click the **Print** button in the toolbar of most software applications. For more information, see the Windows Help.

Change the print settings for the current job

You can customize the print settings of the HP All-in-One to handle nearly any print task. This section contains the following topics:

- [Set the paper size](#)
- [Set the paper type for printing](#)
- [View the print resolution](#)
- [Change the print speed or quality](#)
- [Change the page orientation](#)
- [Scale the document size](#)
- [Change the saturation, brightness, or color tone](#)
- [Preview your print job](#)

Set the paper size

The paper size setting helps the HP All-in-One determine the printable area on the page. Some of the paper size choices have a borderless equivalent, which allows you to print to the top, bottom, and side edges of the paper.

Usually, you set the paper size in the software application you used to create your document or project. However, if you are using custom-size paper, or if you cannot set the paper size from your software application, you can change the paper size in the **Properties** dialog box before printing.

To set the paper size

1. Make sure you have paper loaded in the input tray.
2. On the **File** menu in your software application, click **Print**.
3. Make sure the HP All-in-One is the selected printer.
4. Click the button that opens the **Properties** dialog box.
Depending on your software application, this button might be called **Properties**, **Options**, **Printer Setup**, **Printer**, or **Preferences**.

5. Click the **Features** tab.
6. In the **Resizing Options** area, click the appropriate paper size from the **Size** list. The following table lists the suggested paper size settings for the different types of paper you can load in the input tray. Make sure to look at the long list of choices in the **Size** list to see if a defined paper size already exists for the type of paper you are using.

Paper type	Suggested paper size settings
CD/DVD tattoo paper	5 x 7 in.
Copier, multi-purpose, or plain papers	Letter or A4
Envelopes	Appropriate listed envelope size
Greeting-card papers	Letter or A4
Index cards	Appropriate listed card size (if listed sizes are not appropriate, you can specify a custom paper size)
Inkjet papers	Letter or A4
Iron-on T-shirt transfers	Letter or A4
Labels	Letter or A4
Legal	Legal
Letterhead	Letter or A4
Panorama photo paper	Appropriate listed panorama size (if listed sizes are not appropriate, you can specify a custom paper size)
Photo papers	10 x 15 cm. (with or without tab), 4 x 6 in. (with or without tab), letter, A4, or appropriate listed size
Transparency films	Letter or A4
Custom-size papers	Custom paper size

Set the paper type for printing

If you print on special papers, such as photo paper, transparency film, envelopes, or labels, or if you experience poor print quality, you can set the paper type manually.

To set the paper type for printing

1. Make sure you have paper loaded in the input tray.
2. On the **File** menu in your software application, click **Print**.
3. Make sure the HP All-in-One is the selected printer.
4. Click the button that opens the **Properties** dialog box. Depending on your software application, this button might be called **Properties**, **Options**, **Printer Setup**, **Printer**, or **Preferences**.
5. Click the **Features** tab.
6. In the **Basic Options** area, click the appropriate paper type from the **Paper Type** list.

View the print resolution

The printer software displays the print resolution in dots per inch (dpi). The dpi varies according to the paper type and print quality that you select in the printer software.

To view the print resolution

1. Make sure you have paper loaded in the input tray.
2. On the **File** menu in your software application, click **Print**.
3. Make sure the HP All-in-One is the selected printer.
4. Click the button that opens the **Properties** dialog box.
Depending on your software application, this button might be called **Properties**, **Options**, **Printer Setup**, **Printer**, or **Preferences**.
5. Click the **Features** tab.
6. In the **Print Quality** drop-down list, select the appropriate print quality setting for your project.
7. In the **Paper Type** drop-down list, select the type of paper that you have loaded.
8. Click the **Resolution** button to view the print resolution dpi.

Change the print speed or quality

The HP All-in-One automatically chooses a print quality and speed setting depending on the paper type setting you select. You can also change the print quality setting to customize the speed and quality of the print process.

To select a print speed or quality

1. Make sure you have paper loaded in the input tray.
2. On the **File** menu in your software application, click **Print**.
3. Make sure the HP All-in-One is the selected printer.
4. Click the button that opens the **Properties** dialog box.
Depending on your software application, this button might be called **Properties**, **Options**, **Printer Setup**, **Printer**, or **Preferences**.
5. Click the **Features** tab.
6. In the **Print Quality** drop-down list, select the appropriate quality setting for your project.



NOTE: To view the maximum dpi that the HP All-in-One will print, click **Resolution**.

7. In the **Paper Type** drop-down list, select the type of paper that you have loaded.

Change the page orientation

The page orientation setting allows you to print your document vertically or horizontally on the page.

Usually, you set the page orientation in the software application you used to create your document or project. However, if you are using custom-size or special HP paper, or if you cannot set the page orientation from your software application, you can change the page orientation in the **Properties** dialog box before printing.

To change the page orientation

1. Make sure you have paper loaded in the input tray.
2. On the **File** menu in your software application, click **Print**.
3. Make sure the HP All-in-One is the selected printer.
4. Click the button that opens the **Properties** dialog box.
Depending on your software application, this button might be called **Properties**, **Options**, **Printer Setup**, **Printer**, or **Preferences**.
5. Click the **Features** tab.
6. In the **Basic Options** area, click one of the following:
 - Click **Portrait** to print the document vertically on the page.
 - Click **Landscape** to print the document horizontally on the page.

Scale the document size

The HP All-in-One allows you to print the document at a different size than the original.

To scale the document size

1. Make sure you have paper loaded in the input tray.
2. On the **File** menu in your software application, click **Print**.
3. Make sure the HP All-in-One is the selected printer.
4. Click the button that opens the **Properties** dialog box.
Depending on your software application, this button might be called **Properties**, **Options**, **Printer Setup**, **Printer**, or **Preferences**.
5. Click the **Features** tab.
6. In the **Resizing options** area, click **Scale to paper size**, and then click the appropriate paper size from the drop-down list.

Change the saturation, brightness, or color tone

You can change the intensity of colors and the level of darkness in your printout by adjusting the **Saturation**, **Brightness**, and **Color Tone** options.

To change the saturation, brightness, or color tone

1. Make sure you have paper loaded in the input tray.
2. On the **File** menu in your software application, click **Print**.
3. Make sure the HP All-in-One is the selected printer.
4. Click the button that opens the **Properties** dialog box.
Depending on your software application, this button might be called **Properties**, **Options**, **Printer Setup**, **Printer**, or **Preferences**.
5. Click the **Color** tab.
6. Click the **More color options** button.
7. Move the sliders to adjust the **Saturation**, **Brightness**, or **Color Tone**.
 - **Brightness** indicates the lightness or darkness of the printed document.
 - **Saturation** is the relative purity of printed colors.
 - **Color tone** affects the perceived warmth or coolness of printed colors, by adding more orange or blue tones, respectively, to your image.

Preview your print job

You can preview your print job before sending it to the HP All-in-One. This helps to prevent wasting paper and ink on projects that do not print as expected.

To preview your print job

1. Make sure you have paper loaded in the input tray.
2. On the **File** menu in your software application, click **Print**.
3. Make sure the HP All-in-One is the selected printer.
4. Click the button that opens the **Properties** dialog box.
Depending on your software application, this button might be called **Properties**, **Options**, **Printer Setup**, **Printer**, or **Preferences**.
5. Select the print settings appropriate for your project on each of the tabs in the dialog box.
6. Click the **Features** tab.
7. Select the **Show Preview Before Printing** check box.
8. Click **OK**, and then click **Print** or **OK** in the **Print** dialog box.
Your print job displays in the preview window.
9. In the **HP preview** window, do one of the following:
 - To print, click **Start Printing**.
 - To cancel, click **Cancel Printing**.

Change the default print settings

If there are settings that you frequently use for printing, you might want to make them the default print settings so they are already set when you open the **Print** dialog box from within your software application.

To change the default print settings

1. In the HP Solution Center, click **Settings**, point to **Print Settings**, and then click **Printer Settings**.
2. Make changes to the print settings, and click **OK**.

Printing shortcuts

Use printing shortcuts to print with print settings that you use often. The printer software has several specially designed printing shortcuts that are available in the Printing Shortcuts list.

 **NOTE:** When you select a printing shortcut the appropriate printing options are automatically displayed. You can leave them as is or change them. You can also create a shortcut. For more information, see [Create printing shortcuts](#).

Use the Printing Shortcuts tab for the following print tasks:

- **General Everyday Printing:** Print documents quickly.
- **Photo Printing–Borderless:** Print to the top, bottom, and side edges of 10 x 15 cm (4 x 6 inch) HP Premium Plus Photo Papers with a tear-off tab. For more information, see [Print a borderless image](#).
- **Photo Printing–With White Borders:** Print a photo with a white border around the edges. For more information, see [Print a photo on photo paper](#).
- **Fast/Economical printing:** Produce draft-quality printouts quickly.
- **Presentation printing:** Print high-quality documents, including letters and transparencies. For more information, see [Print from a software application](#) and [Print on transparencies](#).
- **Two-sided (Duplex) Printing:** Print two-sided pages with the HP All-in-One manually. For more information, see [Print on both sides of the page](#).

Create printing shortcuts

In addition to the printing shortcuts that are available in the Printing Shortcuts list, you can create your own printing shortcuts.

If you frequently print on transparency film, for example, you can create a printing shortcut by selecting the Presentation Printing shortcut, changing the paper type to HP Premium Inkjet Transparency Film, and then saving the modified shortcut under a new name; for example, Transparency Presentations. After creating the printing shortcut, simply select it when printing on transparency film rather than changing the print settings each time.

To create a printing shortcut

1. On the **File** menu in your software application, click **Print**.
2. Make sure the HP All-in-One is the selected printer.
3. Click the button that opens the **Properties** dialog box.
Depending on your software application, this button might be called **Properties**, **Options**, **Printer Setup**, **Printer**, or **Preferences**.
4. Click the **Printing Shortcuts** tab.
5. In the **Printing Shortcuts** list, click a printing shortcut.
The print settings for the selected printing shortcut are displayed.
6. Change the print settings to those you want in the new printing shortcut.
7. In the **Type new shortcut name here** box, type a name for the new printing shortcut, and then click **Save**.
The printing shortcut is added to the list.

To delete a printing shortcut

1. On the **File** menu in your software application, click **Print**.
2. Make sure the HP All-in-One is the selected printer.
3. Click the button that opens the **Properties** dialog box.
Depending on your software application, this button might be called **Properties**, **Options**, **Printer Setup**, **Printer**, or **Preferences**.
4. Click the **Printing Shortcuts** tab.

5. In the **Printing Shortcuts** list, click the printing shortcut that you want to delete.
6. Click **Delete**.
The printing shortcut is removed from the list.



NOTE: Only the shortcuts that you have created can be deleted. The original HP shortcuts cannot be deleted.

Perform special print jobs

In addition to supporting standard print jobs, the HP All-in-One can perform special jobs such as printing borderless images, iron-on transfers, and posters.

This section contains the following topics:

- [Print a borderless image](#)
- [Print a photo on photo paper](#)
- [Create custom cd/dvd labels](#)
- [Print using Maximum dpi](#)
- [Print on both sides of the page](#)
- [Print a multiple-page document as a booklet](#)
- [Print multiple pages on a single sheet](#)
- [Print a multiple-page document in reverse order](#)
- [Reverse an image for iron-on transfers](#)
- [Print on transparencies](#)
- [Print a group of addresses on labels or envelopes](#)
- [Print a poster](#)
- [Print a Web page](#)

Print a borderless image

Borderless printing lets you print to the top, bottom, and side edges of 10 x 15 cm (4 x 6 inch) HP Premium Plus Photo Papers with a tear-off tab. When you remove the tear-off tab, the printed image is borderless and extends to the edges of the paper.



TIP: You can automatically adjust the settings in the **Properties** dialog box to print a borderless 10 x 15 cm (4 x 6 inch) photo on HP Premium Plus Photo Paper. Click the **Printing Shortcuts** tab, and then, in the **Printing Shortcuts** list, select **Photo printing-borderless**. You can also set the options manually as described in the following procedure.

To print a borderless image

1. Remove all paper from the input tray, and then load the photo paper print side down.
2. On the **File** menu in your software application, click **Print**.
3. Make sure the HP All-in-One is the selected printer.
4. Click the button that opens the **Properties** dialog box.
Depending on your software application, this button might be called **Properties**, **Options**, **Printer Setup**, **Printer**, or **Preferences**.
5. Click the **Features** tab.

6. In the **Resizing Options** area, click the appropriate paper size from the **Size** list. If a borderless image can be printed on the specified size, the **Borderless** check box is enabled.
7. In the **Basic options** area, click a paper type in the **Paper Type** drop-down list.



NOTE: You cannot print a borderless image if the paper type is set to **Automatic** or to a type of paper other than a photo paper.

8. Select the **Borderless printing** check box if it is not already checked. If the borderless paper size and paper type are not compatible, the HP All-in-One software displays an alert and allows you to select a different type or size.
9. Click **OK**, and then click **Print** or **OK** in the **Print** dialog box.



NOTE: Do not leave unused photo paper in the input tray. The paper might start to curl, which could reduce the quality of your printout. Photo paper should be flat before printing.

Related topics

[Load 10 x 15 cm \(4 x 6 inch\) photo paper](#)

Print a photo on photo paper

For high-quality photo printing, HP recommends you use HP Premium Plus Photo Papers with the HP All-in-One.

You can also improve the quality of the photos you print with the HP All-in-One by purchasing a photo print cartridge. With the tri-color print cartridge and photo print cartridge installed, you have a six-ink system, which provides enhanced quality color photos.

To print a photo on photo paper

1. Remove all paper from the input tray, and then load the photo paper print side down.
2. On the **File** menu in your software application, click **Print**.
3. Make sure the HP All-in-One is the selected printer.
4. Click the button that opens the **Properties** dialog box. Depending on your software application, this button might be called **Properties**, **Options**, **Printer Setup**, **Printer**, or **Preferences**.
5. Click the **Features** tab.
6. In the **Basic Options** area, select the appropriate photo paper type from the **Paper Type** drop-down list.
7. In the **Resizing Options** area, click the appropriate paper size from the **Size** list. If the paper size and paper type are not compatible, the HP All-in-One software displays an alert and allows you to select a different type or size.
8. In the **Basic Options** area, select a high print quality, such as **Best** or **Maximum dpi** from the **Print Quality** drop-down list.

9. In the **HP real life technologies** area, click the **Photo fix** drop-down list and select from the following options:
 - **Off**: applies no **HP real life technologies** to the image.
 - **Basic**: automatically focuses the image; moderately adjusts image sharpness.
 - **Full**: automatically lightens dark images; automatically adjusts sharpness, contrast, and focus of images; automatically removes red-eye.
10. Click **OK** to return to the **Properties** dialog box.
11. If you want to print the photo in black and white, click the **Color** tab and select the **Print in grayscale** check box.
12. Click **OK**, and then click **Print** or **OK** in the **Print** dialog box.

 **NOTE:** Do not leave unused photo paper in the input tray. The paper might start to curl, which could reduce the quality of your printout. Photo paper should be flat before printing.

Related topics

- [Handle the print cartridges](#)
- [Work with print cartridges](#)

Create custom cd/dvd labels

You can create custom labels for your CDs and DVDs on the HP All-in-One by following the steps below. Or, to create custom CD and DVD labels online, go to www.hp.com and follow the prompts.

To create custom CD/DVD labels

1. Make sure you have CD/DVD tattoo paper loaded in the input tray.
2. On the **File** menu in your software application, click **Print**.
3. Make sure the HP All-in-One is the selected printer.
4. Click the button that opens the **Properties** dialog box.
Depending on your software application, this button might be called **Properties**, **Options**, **Printer Setup**, **Printer**, or **Preferences**.
5. Click the **Features** tab.
6. In the **Paper Type** drop-down list, click **More**, and then select **HP CD/DVD tattoo paper** from the list.
7. Click **OK**, and then click **Print** or **OK** in the **Print** dialog box.

Print using Maximum dpi

Use **Maximum dpi** mode to print high-quality, sharp images.

To get the most benefit from **Maximum dpi** mode, use it to print high-quality images such as digital photographs. When you select the **Maximum dpi** setting, the printer software displays the optimized dots per inch (dpi) that the HP All-in-One will print.

Printing in **Maximum dpi** takes longer than printing with other settings and requires a large amount of disk space.

 **NOTE:** If a photo print cartridge is also installed, the print quality is enhanced. A photo print cartridge can be purchased separately if it is not included with the HP All-in-One.

To print in Maximum dpi mode

1. Make sure you have paper loaded in the input tray.
2. On the **File** menu in your software application, click **Print**.
3. Make sure the HP All-in-One is the selected printer.
4. Click the button that opens the **Properties** dialog box.
Depending on your software application, this button might be called **Properties**, **Options**, **Printer Setup**, **Printer**, or **Preferences**.
5. Click the **Features** tab.
6. In the **Paper Type** drop-down list, click **More**, and then select the appropriate paper type.
7. In the **Print Quality** drop-down list, click **Maximum dpi**.

 **NOTE:** To view the maximum dpi that the HP All-in-One will print, click **Resolution**.

8. Select any other print settings that you want, and then click **OK**.

Related topics

- [Use a photo print cartridge](#)
- [Work with print cartridges](#)

Print on both sides of the page

You can print two-sided pages with the HP All-in-One manually. When printing two-sided pages, make sure to use paper that is thick enough so that images do not show through to the other side.

To print on both sides of the page

1. Load paper into the input tray.
2. On the **File** menu in your software application, click **Print**.
3. Make sure the HP All-in-One is the selected printer.
4. Click the button that opens the **Properties** dialog box.
Depending on your software application, this button might be called **Properties**, **Options**, **Printer Setup**, **Printer**, or **Preferences**.
5. Click the **Features** tab.
6. In the **Paper saving options** area, select **Manual** from the **Two-sided printing** drop-down list.

7. For binding, do one of the following:

- For binding on the top like a notebook or calendar, select the **Flip Pages Up** check box.

This causes the odd and even pages of your document to print opposite of each other top-to-bottom. This ensures that the top of the page is always at the top of the sheet when you flip the pages up in your bound document.

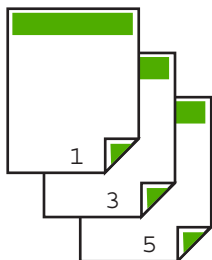

- For binding on the side like a book or magazine, click to clear the **Flip pages up** check box.

This causes the odd and even pages of your document to print opposite of each other left-to-right. This ensures that the top of the page is always at the top of the sheet when you turn the pages in your bound document.

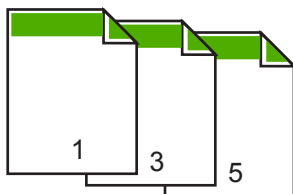

8. Click **OK**, and then click **Print** or **OK** in the **Print** dialog box.

The HP All-in-One begins printing. Wait until all the odd-numbered pages are printed before removing any of the printed pages from the output tray.

A dialog box displays instructions on the screen when it is time to process the second side of your job. Do **not** click **Continue** in the dialog box until you have reloaded the paper as instructed.

9. Follow the instructions that appear on your screen for reloading the paper to print on the second side, and then click **Continue**.

Print a multiple-page document as a booklet

The HP All-in-One allows you to print your document as a small booklet, which you can fold and then staple together.

For best results, design your document to fit on a multiple of four pages, such as an 8, 12, or 16-page program for a child's school play or for a wedding.

To print a multiple-page document as a booklet

1. Load paper into the input tray.
The paper should be thick enough that the images do not show through to the other side.
2. On the **File** menu in your software application, click **Print**.
3. Make sure the HP All-in-One is the selected printer.
4. Click the button that opens the **Properties** dialog box.
Depending on your software application, this button might be called **Properties**, **Options**, **Printer Setup**, **Printer**, or **Preferences**.
5. Click the **Features** tab.
6. In the **Paper saving options** area, select **Manual** from the **Two-sided printing** drop-down list.
7. Select the binding edge from the **Booklet layout is** list, as appropriate for your language.
 - If your language reads left-to-right, click **Left edge binding**.
 - If your language reads right-to-left, click **Right edge binding**.The **Pages per sheet** box is automatically set to two pages per sheet.
8. Click **OK**, and then click **Print** or **OK** in the **Print** dialog box.
The HP All-in-One begins printing.
A dialog box displays instructions on the screen when it is time to process the second side of your job. Do **not** click **Continue** in the dialog box until you have reloaded the paper as instructed in the following steps.
9. Wait until the HP All-in-One has stopped printing for several seconds before removing any of the printed pages from the output tray.
If you remove the pages while the document is still printing, the pages might get out of order.

10. Follow the instructions that appear on your screen for reloading the paper to print on the second side, and then click **Continue**.
11. When the entire document has finished printing, fold the stack of paper in half, so that the first page is on top, then staple the document along the crease.

 **TIP:** For best results, use a saddle stapler, or a heavy-duty stapler with a long reach to staple the booklet.

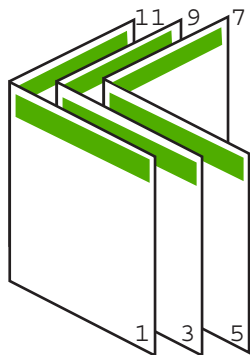

Figure 7-1 Left-edge binding for left-to-right languages

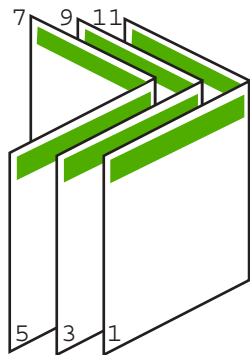

Figure 7-2 Right-edge binding for right-to-left languages

Print multiple pages on a single sheet

You can print up to 16 pages on a single sheet of paper.

To print multiple pages on a single sheet

1. Make sure you have paper loaded in the input tray.
2. On the **File** menu in your software application, click **Print**.
3. Make sure the HP All-in-One is the selected printer.

4. Click the button that opens the **Properties** dialog box.
Depending on your software application, this button might be called **Properties**, **Options**, **Printer Setup**, **Printer**, or **Preferences**.
5. Click the **Features** tab.
6. In the **Pages per sheet** list, click **2**, **4**, **6**, **8**, **9**, or **16**.
7. In the **Page Order** list, click an appropriate page order option.
The sample output graphic is numbered to show how the pages will be ordered if you select each option.
8. Click **OK**, and then click **Print** or **OK** in the **Print** dialog box.

Print a multiple-page document in reverse order

If the first page that prints is face-up at the bottom of the stack, this usually means you need to put the printed pages in the correct order.

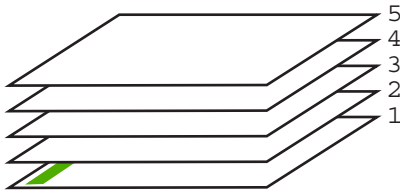

A better way is to print the document in reverse order so that the pages are stacked correctly.

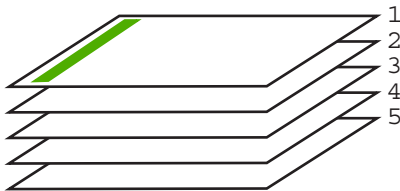

 **TIP:** Set this option as a default setting so you do not have to remember to set it every time you print a multiple-page document.

To print a multiple-page document in reverse order

1. Make sure you have paper loaded in the input tray.
2. On the **File** menu in your software application, click **Print**.
3. Make sure the HP All-in-One is the selected printer.
4. Click the button that opens the **Properties** dialog box.
Depending on your software application, this button might be called **Properties**, **Options**, **Printer Setup**, **Printer**, or **Preferences**.
5. Click the **Advanced** tab.
6. Expand the **Document Options** list, and then expand the **Layout Options** list.

- Click **Page Order** in the **Layout Options** list, and then click **Front to Back**.



NOTE: If you set your document to print on both sides of the page, the **Front to back** option is not available. Your document will automatically print in the correct order.

- Click **OK**, and then click **Print** or **OK** in the **Print** dialog box.
When you are printing multiple copies, each set is printed completely before the next set is printed.

Reverse an image for iron-on transfers

This feature reverses an image so you can use it for iron-on transfers. This feature is also useful for transparencies when you want to make notations on the back of the transparency without scratching the original.

To reverse an image for iron-on transfers

- On the **File** menu in your software application, click **Print**.
- Make sure the HP All-in-One is the selected printer.
- Click the button that opens the **Properties** dialog box.
Depending on your software application, this button might be called **Properties**, **Options**, **Printer Setup**, **Printer**, or **Preferences**.
- Click the **Features** tab.
- In the **Basic options** area, click **HP Iron-on Transfer** from the **Paper Type** list.
- Click the **Advanced** tab.
- Expand the **Document Options**, and then expand the **Printer Features**.
- Set **Mirror Image** to **On**.
- Click **OK**, and then click **Print** or **OK** in the **Print** dialog box.



NOTE: To prevent jams, manually feed the iron-on transfer sheets into the input tray one sheet at a time.

Print on transparencies

For the best results, HP recommends you use HP transparency products with the HP All-in-One.

To print on transparencies

- Load the transparency into the input tray.
- On the **File** menu in your software application, click **Print**.
- Make sure the HP All-in-One is the selected printer.
- Click the button that opens the **Properties** dialog box.
Depending on your software application, this button might be called **Properties**, **Options**, **Printer Setup**, **Printer**, or **Preferences**.
- Click the **Features** tab.

6. In the **Basic Options** area, click the appropriate transparency type in the **Paper Type** list.

 **TIP:** If you want to make notations on the back of the transparencies and erase them later without scratching the original, click the **Advanced** tab, and select the **Mirror Image** check box.

7. In the **Resizing Options** area, click an appropriate size in the **Size** list.
8. Click **OK**, and then click **Print** or **OK** in the **Print** dialog box.

The HP All-in-One automatically waits for transparencies to dry before releasing them. Ink dries slower on film than on plain paper. Make sure you allow enough time for the ink to dry before handling the transparency.

Print a group of addresses on labels or envelopes

With the HP All-in-One, you can print on a single envelope, a group of envelopes, or label sheets designed for inkjet printers.

To print a group of addresses on labels or envelopes

1. Print a test page on plain paper first.
2. Place the test page on top of the label sheet or envelope, and hold both up to the light. Check the spacing for each block of text. Make adjustments as needed.
3. Load the labels or envelopes into the input tray.

 **CAUTION:** Do not use envelopes with clasps or windows. They can get stuck in the rollers and cause paper jams.

4. If you are printing on envelopes, do the following:
 - a. Display the print settings, and click the **Features** tab.
 - b. In the **Resizing Options** area, click the appropriate envelope size in the **Size** list.
5. Click **OK**, and then click **Print** or **OK** in the **Print** dialog box.

Related topics

[Load envelopes](#)

Print a poster

You can create a poster by printing a document on multiple pages. The HP All-in-One prints dotted lines on some pages to indicate where to trim the pages before taping them together.

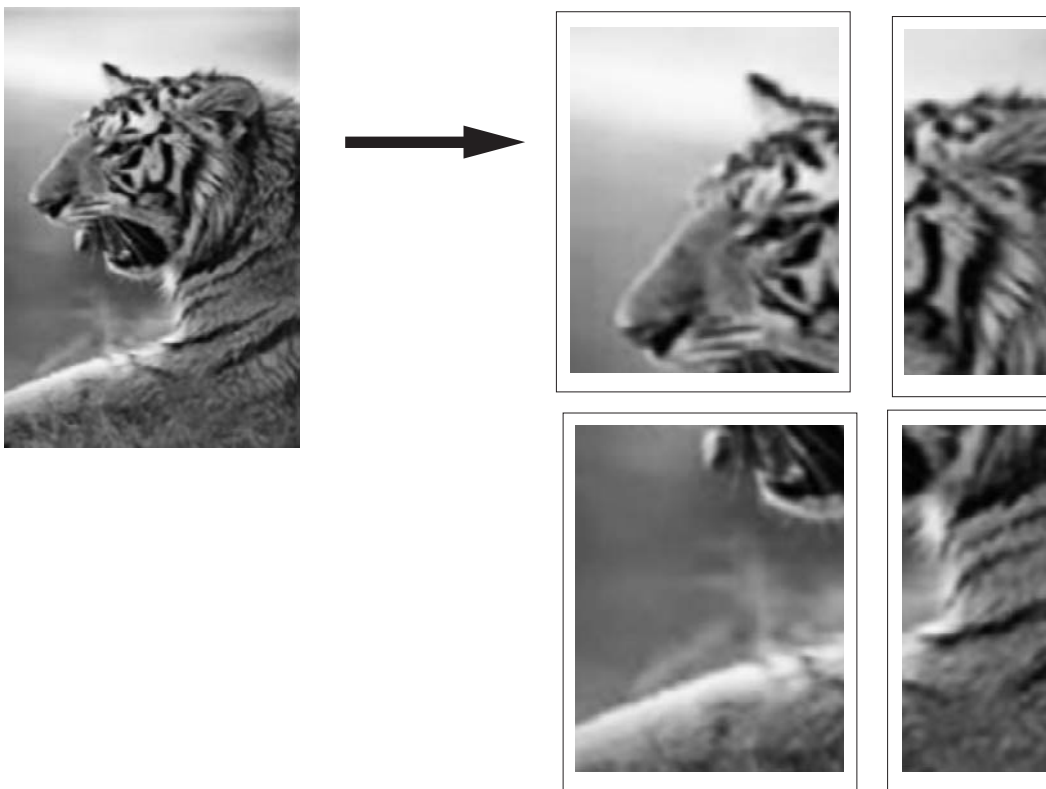

To print a poster

1. Make sure you have paper loaded in the input tray.
2. On the **File** menu in your software application, click **Print**.
3. Make sure the HP All-in-One is the selected printer.
4. Click the button that opens the **Properties** dialog box.
Depending on your software application, this button might be called **Properties**, **Options**, **Printer Setup**, **Printer**, or **Preferences**.
5. Click the **Advanced** tab.
6. Expand the **Document Options**, and then expand the **Printer Features**.

7. In the **Poster Printing** drop-down list, click either **2x2 (4 sheets)**; **3x3 (9 sheets)**; **4x4 (16 sheets)**; or **5x5 (25 sheets)**.

This selection tells the HP All-in-One to enlarge your document so that it fits on 4, 9, 16, or 25 pages.

If your original document is multiple pages, each of those pages will be printed on 4, 9, 16, or 25 pages. For example, if you have a one-page original and you select 3x3, you will get 9 pages; if you select 3x3 for a two-page original, 18 pages will print.

8. Click **OK**, and then click **Print** or **OK** in the **Print** dialog box.
9. After the poster has printed, trim the edges of the sheets and tape the sheets together.

Print a Web page

You can print a Web page from your Web browser on the HP All-in-One.

To print a Web page

1. Make sure you have paper loaded in the input tray.
2. On the **File** menu in your Web browser, click **Print**.
The **Print** dialog box appears.
3. Make sure the HP All-in-One is the selected printer.
4. If your Web browser supports it, select the items on the Web page that you want to include in the printout.
For example, in Internet Explorer, click the **Options** tab to select options such as **As laid out on screen**, **Only the selected frame**, and **Print all linked documents**.
5. Click **Print** or **OK** to print the Web page.

 **TIP:** To print Web pages correctly, you might need to set your print orientation to **Landscape**.

Stop a print job

Although you can stop a print job from either the HP All-in-One or the computer, HP recommends you stop it from the HP All-in-One for best results.

 **NOTE:** Although most software applications designed for Windows use the Windows print spooler, your software application might not use the spooler. An example of a software application that does not use the Windows print spooler is PowerPoint in Microsoft Office 97.

If you cannot cancel your print job by using one of the following procedures, consult the instructions for canceling background printing in the online help for your software application.

To stop a print job from the HP All-in-One

- ▲ Press **Cancel** on the control panel. If the print job does not stop, press **Cancel** again. It can take a few moments for printing to be cancelled.

To stop a print job from the computer

- ▲ You can cancel most print jobs from the print queue. For more information about how to do this, see the Windows Help.

Related topics

[Control panel buttons](#)

Resume a print job

If an error occurs while printing, you may need to resume the job from the HP All-in-One or the computer after you address the error.

To resume a print job from the control panel

- ▲ On the control panel, press **Resume**.

To resume a print job from the computer

- ▲ You can resume some print jobs from the print queue. For more information about how to do this, see the Windows Help.

Related topics

[Control panel buttons](#)

8 Use the copy features

The HP All-in-One allows you to produce high-quality color and black-and-white copies on a variety of paper types. You can enlarge or reduce the size of an original to fit a specific paper size, adjust the copy quality, and make high-quality copies of photos, including borderless copies.

This section contains the following topics:

- [Make a copy](#)
- [Set the copy paper type](#)
- [Change copy speed](#)
- [Make multiple copies of the same original](#)
- [Copy a two-page black-and-white document](#)
- [Make a 10 x 15 cm \(4 x 6 inch\) borderless copy of a photo](#)
- [Stop copying](#)

Make a copy

You can make quality copies from the control panel.

To make a copy from the control panel

1. Make sure you have paper loaded in the input tray.
2. Place your original with the side you want to copy or scan face down on the left front corner of the glass.

 **TIP:** For quality copies, ensure that the scanner glass is clean and that there are no foreign materials adhering to it. For more information, see [Clean the glass](#).

3. Press the **Paper Type** button to set the paper type.
4. Press **Start Copy Black** or **Start Copy Color**.

Related topics

[Control panel buttons](#)

Set the copy paper type

You can set the paper type for copying to either **Plain** or **Photo**.

To set the paper type for copies

1. Make sure you have paper loaded in the input tray.
2. Place your original with the side you want to copy or scan face down on the left front corner of the glass.

3. Press the **Paper Type** button to set the paper type.

Copies made on photo paper are automatically made using Best quality. When **Photo Paper Type** is selected, the HP All-in-One enlarges or shrinks the original to fit within the copy margin of the detected paper size.

Copies made on plain paper are automatically made using Normal quality. When the **Plain Paper Type** is selected, the HP All-in-One makes an exact copy of the original placed on the scanner glass.



NOTE: Ensure that the scanner glass is clean for the copy function to work properly.

4. Press **Start Copy Black** or **Start Copy Color**.

Refer to the following table to determine which paper type setting to choose based on the paper loaded in the input tray.

Paper type	Control panel setting
Copier paper or letterhead	Plain
HP Bright White Paper	Plain
HP Premium Plus Photo Paper, Glossy	Photo
HP Premium Plus Photo Paper, Matte	Photo
HP Premium Plus 4 x 6 inch Photo Paper	Photo
HP Photo Paper	Photo
HP Everyday Photo Paper	Photo
HP Everyday Photo Paper, Semi Gloss	Photo
Other photo paper	Photo
HP Premium Paper	Plain
HP All-in-One Paper	Plain
HP Printing Paper	Plain
Other inkjet paper	Plain
Legal	Plain

Related topics

[Control panel buttons](#)

Change copy speed

Copies made from the control panel on regular, plain paper automatically use **Normal** quality.

You can make a Fast copy using the instructions below. Fast copies faster with comparable quality text, but the graphics quality might be lower. Fast copies use less ink and extend the life of your print cartridges.



NOTE: Fast or Normal are not available when the paper type is set to **Photo**.

To make a Fast copy

1. Make sure you have paper loaded in the input tray.
2. Place your original with the side you want to copy or scan face down on the left front corner of the glass.



TIP: For quality copies, ensure that the scanner glass is clean and that there are no foreign materials adhering to it. For more information, see [Clean the glass](#).

3. Press the **Paper Type** button to set the paper type.
4. Press and hold down the **Scan** button, and then press either **Start Copy Black** or **Start Copy Color**.

Related topics

[Control panel buttons](#)

[Set the copy paper type](#)

Make multiple copies of the same original

You can set the number of copies from the control panel or from the software that you installed with the HP All-in-One.

To make multiple copies of an original from the control panel

1. Make sure you have paper loaded in the input tray.
2. Place your original with the side you want to copy or scan face down on the left front corner of the glass.



TIP: For quality copies, ensure that the scanner glass is clean and that there are no foreign materials adhering to it. For more information, see [Clean the glass](#).

3. Press the **Paper Type** button to set the paper type.

4. Press the **Start Copy Black** or **Start Copy Color** button to increase the number of copies up to a maximum of 9 (varies by model).

 **NOTE:** The HP All-in-One waits very briefly for another button press. Pause for a while before pressing the **Start Copy Black** or **Start Copy Color** button again to start the copy job.

 **TIP:** Use the software that you installed with the HP All-in-One to set the number of copies higher than 9.

5. Press **Start Copy Black** or **Start Copy Color**.

In this example, the HP All-in-One makes six copies of the original 10 x 15 cm (4 x 6 inch) photo.

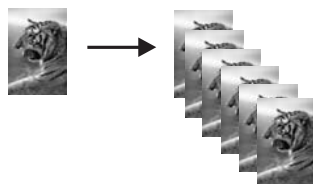

Related topics

[Control panel buttons](#)

Copy a two-page black-and-white document

You can use the HP All-in-One to copy a single- or multiple-page document in color or black and white. In this example, the HP All-in-One is used to copy a two-page black-and-white original.

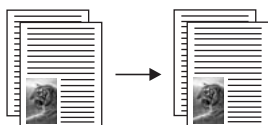

To copy a two-page document from the control panel

1. Make sure you have paper loaded in the input tray.
2. Place your original with the side you want to copy or scan face down on the left front corner of the glass.
3. Press the **Paper Type** button to set the paper type.
4. Press **Start Copy Black**.
5. Remove the first page from the glass and load the second page.
6. Press **Start Copy Black**.

Related topics

[Control panel buttons](#)

Make a 10 x 15 cm (4 x 6 inch) borderless copy of a photo

To make a borderless copy of a photo, use the 10 x 15 cm (4 x 6 inch) HP Premium Plus Photo Paper with a tear-off tab. When you remove the tear-off tab, the output is a borderless copy of the image that extends to the edges of the paper.

To make a borderless copy of a photo from the control panel

1. Load 10 x 15 cm (4 x 6 inch) tabbed photo paper in the input tray.

 **NOTE:** To make a borderless copy, you must use tabbed photo paper.

2. Load your original photo with the side you want to print on face down on the left front corner of the glass.
3. Press **Paper Type** to select the Photo paper type.

 **NOTE:** When the Photo paper type is selected, the HP All-in-One defaults to making a borderless copy with a 10 x 15 cm (4 x 6 inch) original.

4. Press **Start Copy Color**.
The HP All-in-One makes a borderless copy of your original photo, as shown below.



Related topics

[Control panel buttons](#)

Stop copying

To stop copying

- ▲ Press **Cancel** on the control panel.

Related topics

[Control panel buttons](#)

9 Use the scan features

Scanning is the process of converting text and pictures into an electronic format for your computer. You can scan almost anything (photos, magazine articles and text documents) on the HP All-in-One.

You can use the scanning features of the HP All-in-One to do the following:

- Scan text from an article into your word processor and quote it in a report.
- Print business cards and brochures by scanning a logo and using it in your publishing software.
- Send photos to friends and relatives by scanning your favorite prints and including them in e-mail messages.
- Create a photographic inventory of your house or office.
- Archive treasured photos in an electronic scrapbook.

 **NOTE:** If you are using the HP Photosmart Software, the Optical Character Recognition (OCR) software might not be installed on your computer. To install the OCR software, you must re-insert the software disk and select **OCR** under the **Custom** installation options.

This section contains the following topics:

- [Scan an original](#)
- [Edit a scanned preview image](#)
- [Edit a scanned image](#)
- [Edit a scanned document](#)
- [Stop scanning](#)

Scan an original

For original documents or images placed on the glass, you can start a scan from your computer or from the HP All-in-One. This section explains the second option: how to scan from the control panel of the HP All-in-One to a computer.

To use the scan features, the HP All-in-One and computer must be connected and turned on. The HP Photosmart Software must also be installed and running on your computer prior to scanning. To verify that the HP Photosmart Software is running on a Windows computer, look for the **HP Digital Imaging Monitor** icon in the system tray at the lower right side of the screen, near the time.

 **NOTE:** Closing the **HP Digital Imaging Monitor** icon in the Windows system tray can cause the HP All-in-One to lose some of its scan functionality. If this happens, you can restore full functionality by restarting your computer or by starting the HP Photosmart Software.

The HP Photosmart Software that you installed on your computer has many tools that you can use to edit and print your scanned image. You can improve the overall image quality by adjusting the brightness, sharpness, color tone, or saturation. You can also crop, straighten, rotate, or resize the image. When the scanned image looks just the way

you want it, you can open it in another application, send it through e-mail, save it to a file, or print it.



To scan to a computer

1. Place your original with the side you want to copy or scan face down on the left front corner of the glass.

 **TIP:** For quality copies, ensure that the scanner glass is clean and that there are no foreign materials adhering to it. For more information, see [Clean the glass](#).

2. Press **Scan**.

If the original is a document, the HP All-in-One scans it automatically. If the original is a photo, a preview image of the scan appears on your computer, where you can edit it. Any edits that you make apply to the current scan session only.

The HP Photosmart Software has many tools that you can use to edit your scanned image. You can improve the overall image quality by adjusting the brightness, sharpness, color tone, or saturation. You can also crop, rotate, or resize the image.

3. Make any edits to the preview image, and then click **Accept** when you are finished.

Related topics

[Control panel buttons](#)

Edit a scanned preview image

You can use the tools in the **HP Scanning** software to modify a preview image. Any changes that you make, such as brightness, image type, resolution, and more apply only to this scan session.

You can make additional changes in the HP Photosmart software after the image is scanned.

Related topics

[Use the HP Photosmart software](#)

Edit a scanned image

You can edit a scanned image, such as a photo or graphic, using the software you installed with the HP All-in-One. Using this software, you can rotate or crop the image, as well as adjust the brightness, contrast, and color saturation.

 **NOTE:** If you are using the HP Photosmart Software, the Optical Character Recognition (OCR) software might not be installed on your computer. To install the OCR software, you must re-insert the software disk and select **OCR** under the **Custom** installation options.

Related topics

[Use the HP Photosmart software](#)

Edit a scanned document

You can edit a scanned document using your Optical Character Recognition (OCR) software. Scanning text using OCR software enables you to bring the content of magazine articles, books, and other printed matter into your favorite word processor and many other applications as editable text. Learning to use OCR software correctly is important if you want to obtain the best results. Do not expect scanned text documents to be letter-perfect the first time you use your OCR software. Using OCR software is an art that takes time and practice to master.

 **NOTE:** If you are using the HP Photosmart Software, the Optical Character Recognition (OCR) software might not be installed on your computer. To install the OCR software, you must re-insert the software disk and select **OCR** under the **Custom** installation options.

Related topics

[Use the HP Photosmart software](#)

Stop scanning

To stop scanning

▲ Press **Cancel** on the control panel.

Related topics

[Control panel buttons](#)

10 Maintain the HP All-in-One

The HP All-in-One requires little maintenance. Sometimes you might want to clean the glass and lid backing to remove surface dust and ensure that your copies and scans remain clear. You will also need to replace, align, or clean your print cartridges from time to time. This section provides instructions for keeping the HP All-in-One in top working condition. Perform these simple maintenance procedures as necessary.

This section contains the following topics:

- [Clean the HP All-in-One](#)
- [Print a self-test report](#)
- [Work with print cartridges](#)

Clean the HP All-in-One

To ensure that your copies and scans remain clear, you might need to clean the glass and lid backing. You might also want to dust the exterior of the HP All-in-One.

This section contains the following topics:

- [Clean the exterior](#)
- [Clean the glass](#)
- [Clean the lid backing](#)

Clean the exterior

Use a soft cloth or slightly moistened sponge to wipe dust, smudges, and stains off the case. The interior of the HP All-in-One does not require cleaning. Keep fluids away from the control panel and the interior of the HP All-in-One.

△ **CAUTION:** To avoid damage to the exterior of the HP All-in-One, do not use alcohol or alcohol-based cleaning products.

Clean the glass

Fingerprints, smudges, hair, and dust on the main glass surface slow down performance and affect the accuracy of the copy and scan features.

To clean the glass

1. Turn off the HP All-in-One, unplug the power cord, and raise the lid.
2. Clean the glass with a soft cloth or sponge slightly moistened with a nonabrasive glass cleaner.

△ **CAUTION:** Do not use abrasives, acetone, benzene, or carbon tetrachloride on the glass, since they can damage it. Do not place or spray liquid directly on the glass. The liquid might seep under the glass and damage the device.

3. Dry the glass with a dry, soft, lint-free cloth to prevent spotting.
4. Plug in the power cord, and then turn on the HP All-in-One.

Clean the lid backing

Minor debris can accumulate on the white document backing located underneath the lid of the HP All-in-One.

To clean the lid backing

1. Turn off the HP All-in-One, unplug the power cord, and raise the lid.
2. Clean the white document backing with a soft cloth or sponge slightly moistened with a mild soap and warm water.
Wash the backing gently to loosen debris. Do not scrub the backing.
3. Dry the backing with a dry, soft, lint-free cloth.

△ **CAUTION:** Do not use paper-based wipes, as these might scratch the backing.

4. If further cleaning is needed, repeat the previous steps using isopropyl (rubbing) alcohol, and wipe the backing thoroughly with a damp cloth to remove any residual alcohol.

△ **CAUTION:** Be careful not to spill alcohol on the glass or exterior of the HP All-in-One, as this might damage the device.

5. Plug in the power cord, and then turn on the HP All-in-One.

Print a self-test report

If you are experiencing problems with printing, print a self-test report before you replace the print cartridges. This report provides useful information on several aspects of your device, including your print cartridges.

To print a self-test report

1. Load letter or A4 unused plain white paper into the input tray.
2. Press and hold the **Cancel** button and then press the **Start Copy Color** button. The HP All-in-One prints a self-test report, which might indicate the source of the printing problem. A sample of the ink test area of the report is shown below.



3. Make sure the test patterns show a complete grid and the thick color lines are complete.
 - If more than a few lines in a pattern are broken, this might indicate a problem with the nozzles. You might need to clean the print cartridges.
 - If the black line is missing, faded, streaked, or shows lines, this might indicate a problem with the black or photo print cartridge in the right slot.
 - If any of the color lines are missing, faded, streaked, or show lines, this might indicate a problem with the tri-color print cartridge in the left slot.

Related topics

- [Clean the print cartridges](#)
- [Replace the print cartridges](#)
- [Control panel buttons](#)

Work with print cartridges

To ensure the best print quality from the HP All-in-One, you will need to perform some simple maintenance procedures. This section provides guidelines for handling the print cartridges and instructions for replacing, aligning, and cleaning the print cartridges.

You might also need to check your print cartridges if the Check Print Cartridge light is on. This might mean that the print cartridges are not installed properly or are missing, the plastic tape has not been removed from the print cartridges, the print cartridges are out of ink, or the print carriage is blocked.

This section contains the following topics:

- [Handle the print cartridges](#)
- [Check the estimated ink levels](#)
- [Replace the print cartridges](#)
- [Use ink-backup mode](#)
- [Use a photo print cartridge](#)
- [Store the print cartridges](#)
- [Align the print cartridges](#)
- [Clean the print cartridges](#)
- [Clean the print cartridge contacts](#)
- [Clean the area around the ink nozzles](#)
- [Remove ink from your skin and clothing](#)

Handle the print cartridges

Before you replace or clean a print cartridge, you should know the part names and how to handle the print cartridges.

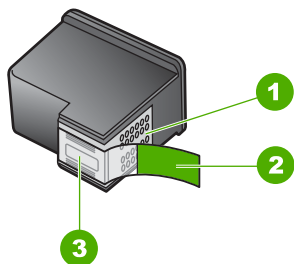

1	Copper-colored contacts
2	Plastic tape with pink pull tab (must be removed before installing)
3	Ink nozzles under tape

Hold the print cartridges by their black plastic sides, with the label on top. Do not touch the copper-colored contacts or the ink nozzles.



 **NOTE:** Handle the print cartridges carefully. Dropping or jarring cartridges can cause temporary printing problems, or even permanent damage.

Check the estimated ink levels

You can easily check the ink supply level to determine how soon you might need to replace a print cartridge. The ink supply level shows an estimate of the amount of ink remaining in the print cartridges.

 **TIP:** You can also print a self-test report to see if your print cartridges might need to be replaced.

 **NOTE:** The HP All-in-One can only detect the ink levels for genuine HP ink. The ink levels in print cartridges that are refilled or have been used in other devices might not register accurately.

NOTE: Ink from the cartridges is used in the printing process in a number of different ways, including in the initialization process, which prepares the device and cartridges for printing, and in printhead servicing, which keeps print nozzles clear and ink flowing smoothly. In addition, some residual ink is left in the cartridge after it is used. For more information, see www.hp.com/go/inkusage.

To check the ink levels from the HP Photosmart Software

1. In the HP Solution Center, click **Settings**, point to **Print Settings**, and then click **Printer Toolbox**.



NOTE: You can also open the **Printer Toolbox** from the **Print Properties** dialog box. In the **Print Properties** dialog box, click the **Services** tab, and then click **Service this device**.

The **Printer Toolbox** appears.

2. Click the **Estimated Ink Level** tab.
The estimated ink levels for the print cartridges appear.

Related topics

[Print a self-test report](#)

Replace the print cartridges

Follow these instructions when the ink level is low.



NOTE: When the ink level for the print cartridge is low, a message appears on your computer screen. You can also check the ink levels by using the software installed with the HP All-in-One.

When you receive a low-ink warning message, make sure you have a replacement print cartridge available. You should also replace the print cartridges when you see faded text or if you experience print quality issues related to the print cartridges.

To order print cartridges for the HP All-in-One, go to www.hp.com/buy/supplies. If prompted, choose your country/region, follow the prompts to select your product, and then click one of the shopping links on the page.

Choose the right cartridge combination

Choose the best combination of cartridges for your print job:

- Everyday printing: Use a black cartridge along with a tri-color cartridge.
- Color photos: Use a photo cartridge along with a tri-color cartridge.



To replace the print cartridges

1. Make sure the HP All-in-One is on.

△ **CAUTION:** If the HP All-in-One is off when you open the print cartridge door to access the print cartridges, the HP All-in-One will not release the cartridges for changing. You might damage the HP All-in-One if the print cartridges are not docked safely when you try to remove them.

2. Open the print cartridge door.

The print carriage should move to the center of the HP All-in-One. If the print carriage does not move to the center, turn the HP All-in-One off, and then on.

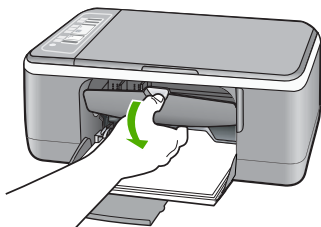

3. Wait until the print carriage is idle and silent, and then lightly press down on a print cartridge to release it.

If you are replacing the tri-color print cartridge, remove the print cartridge from the slot on the left.

If you are replacing the black or photo print cartridge, remove the print cartridge from the slot on the right.

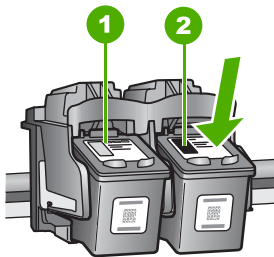

- | | |
|---|---|
| 1 | Print cartridge slot for the tri-color print cartridge |
| 2 | Print cartridge slot for the black and photo print cartridges |

4. Pull the print cartridge toward you out of its slot.

5. If you are removing the black print cartridge in order to install the photo print cartridge, store the black print cartridge in the print cartridge protector or an airtight plastic container.

If you are removing the print cartridge because it is low or out of ink, recycle the print cartridge. The HP Inkjet Supplies Recycling Program is available in many countries/regions, and lets you recycle used print cartridges free of charge. For more information, go to the following Web site:

www.hp.com/hpinfo/globalcitizenship/environment/recycle/inkjet.html

6. Remove the new print cartridge from its packaging, being careful to touch only the black plastic. Gently remove the plastic tape using the pink pull tab.

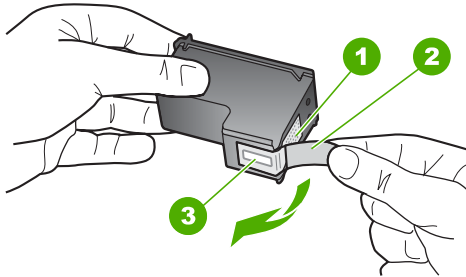

1	Copper-colored contacts
2	Plastic tape with pink pull tab (must be removed before installing)
3	Ink nozzles under tape

CAUTION: Do not touch the copper-colored contacts or ink nozzles. Touching these parts can result in clogs, ink failure, and bad electrical connections.



- Slide the new print cartridge forward into the empty slot. Then gently push on the upper part of the print cartridge forward until it clicks into the socket.
If you are installing the tri-color print cartridge, slide it into the left slot.
If you are installing a black or photo print cartridge, slide it into the right slot.

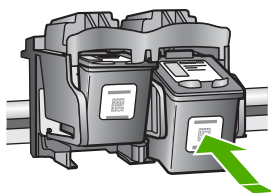

- Close the print cartridge door.

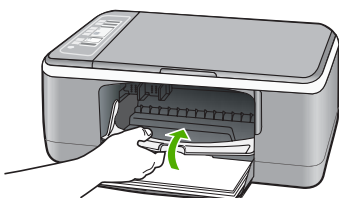

- If the print cartridge alignment sheet prints, load it on the left front corner of the glass with the top of the page to the left.

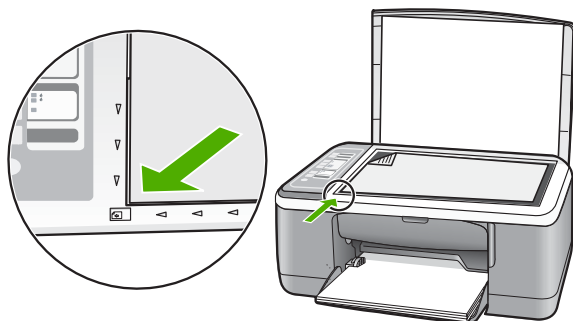

- Press the **Scan** button.
The HP All-in-One aligns the print cartridges. Recycle or discard the print cartridge alignment sheet.

Related topics

- [Check the estimated ink levels](#)
- [Control panel buttons](#)

Use ink-backup mode

Use the ink-backup mode to operate the HP All-in-One with only one print cartridge. The ink-backup mode is initiated when a print cartridge is removed from the print cartridge cradle.

 **NOTE:** When the HP All-in-One operates in ink-backup mode, a message is displayed on screen. If the message is displayed and two print cartridges are installed in the device, verify that the protective piece of plastic tape has been removed from each print cartridge. When plastic tape covers the print cartridge contacts, the device cannot detect that the print cartridge is installed.

For more information about ink-backup mode, see the following topics:

- [Ink-backup mode output](#)
- [Exit ink-backup mode](#)

Ink-backup mode output

Printing in ink-backup mode slows the HP All-in-One and affects the quality of printouts.

Installed print cartridge	Result
Black print cartridge	Colors print as grayscale.
Tri-color print cartridge	Colors print but black is grayed and is not a true black.
Photo print cartridge	Colors print as grayscale.

 **NOTE:** HP does not recommend using the photo print cartridge for ink-backup mode.

Exit ink-backup mode

Install two print cartridges in the HP All-in-One to exit ink-backup mode.

For information about installing a print cartridge, see [Replace the print cartridges](#).

Use a photo print cartridge

You can optimize the quality of the color photos you print and copy with the HP All-in-One by purchasing a photo print cartridge. Remove the black print cartridge and insert the photo print cartridge in its place. With the tri-color print cartridge and photo print cartridge installed, you have a six-ink system, which provides enhanced quality color photos.

When you want to print regular text documents, swap the black print cartridge back in. Use a print cartridge protector or an airtight plastic container to keep your print cartridge secure when it is not being used.

Related topics

- [Replace the print cartridges](#)
- [Control panel buttons](#)

Store the print cartridges

Follow these guidelines to maintain and store HP print cartridges and to ensure consistent print quality.

- [Print cartridge storage and handling](#)
- [Print cartridge protector](#)

Print cartridge storage and handling

Follow these guidelines to help maintain HP print cartridges and ensure consistent print quality:

- Install the cartridge on or before the **Install by** date, which is printed on the cartridge package.
- When you remove a print cartridge from the device, store it in an airtight plastic container to prevent the ink from drying out. If you are storing a photo print cartridge, you can use a print cartridge protector. For more information, see [Print cartridge protector](#).
- Keep all unused print cartridges in their original sealed packages until they are needed. Store print cartridges at room temperature (15–35 degrees C or 59–95 degrees F).
- Do not remove the plastic tape covering the ink nozzles until you are ready to install the print cartridge in the device. If the plastic tape has been removed from the print cartridge, do not attempt to reattach it. Reattaching the tape damages the print cartridge.

△ **CAUTION:** Always turn the HP All-in-One off with the Power button before you unplug the power cord or turn off a power strip. This allows the device to store the print cartridges properly. When you store the HP All-in-One, always leave the active print cartridges inside the device.

Print cartridge protector

In some countries/regions, when you purchase a photo print cartridge, you might also receive a print cartridge protector. If a print cartridge protector is not available, you can use an airtight plastic container to protect your print cartridge.

The print cartridge protector is designed to keep a print cartridge secure and prevent it from drying out when it is not being used. Whenever you remove a print cartridge from the HP All-in-One with the intention of using it again later, store it in the print cartridge protector. For example, store the black print cartridge in a print cartridge protector if you

are removing it so you can print high-quality photos with the photo and tri-color print cartridges.

To insert a print cartridge into the print cartridge protector

- ▲ Place the print cartridge into the print cartridge protector at a slight angle and snap it securely into place.

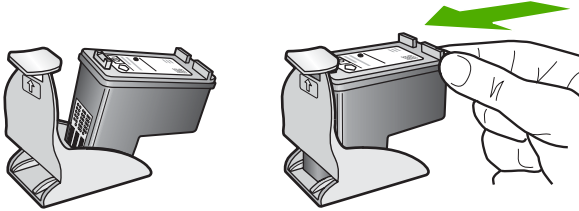

To remove the print cartridge from the print cartridge protector

- ▲ Press down on the top of the print cartridge protector to release the print cartridge, then gently remove the print cartridge out of the print cartridge protector.

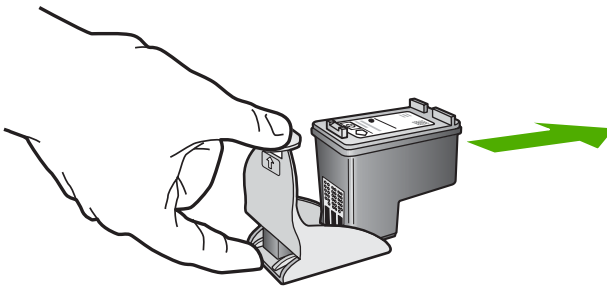

Align the print cartridges

The HP All-in-One prompts you to align cartridges every time you install or replace a print cartridge. You can also align the print cartridges at any time from the control panel or by using the software you installed with the HP All-in-One. Aligning the print cartridges ensures high-quality output.

-
- 📄 **NOTE:** If you remove and reinstall the same print cartridge, the HP All-in-One will not prompt you to align the print cartridges. The HP All-in-One remembers the alignment values for that print cartridge, so you do not need to realign the print cartridges.
-

To align newly installed print cartridges

1. Make sure you have letter or A4 unused plain white paper loaded in the input tray. The HP All-in-One prints a print cartridge alignment sheet.

 **NOTE:** If you have colored paper loaded in the input tray when you align the print cartridges, the alignment will fail. Load unused plain white paper into the input tray, and then try the alignment again.

If the alignment fails again, you might have a defective sensor or print cartridge. Contact HP Support. Go to www.hp.com/support. If prompted, choose your country/region, and then click **Contact HP** for information on calling for technical support.

2. Load the print cartridge alignment sheet print side down on the left front corner of the glass with the top of the page to the left.
3. Press the **Scan** button.
The HP All-in-One aligns the print cartridges. Recycle or discard the print cartridge alignment sheet.

To align the print cartridges from the HP Photosmart Software

1. Load letter or A4 unused plain white paper into the input tray.

 **NOTE:** If you have colored paper loaded in the input tray when you align the print cartridges, the alignment will fail. Load unused plain white paper into the input tray, and then try the alignment again.

If the alignment fails again, you might have a defective sensor or print cartridge. Contact HP Support. Go to www.hp.com/support. If prompted, choose your country/region, and then click **Contact HP** for information on calling for technical support.

2. In the HP Solution Center, click **Settings**, point to **Print Settings**, and then click **Printer Toolbox**.

 **NOTE:** You can also open the **Printer Toolbox** from the **Print Properties** dialog box. In the **Print Properties** dialog box, click the **Services** tab, and then click **Service this device**.

The **Printer Toolbox** appears.

3. Click the **Device Services** tab.
4. Click **Align the Print Cartridges**.
The HP All-in-One prints a print cartridge alignment sheet.
5. Load the print cartridge alignment sheet print side down on the left front corner of the glass.
6. Press the **Scan** button.
The HP All-in-One aligns the print cartridges. Recycle or discard the print cartridge alignment sheet.

Related topics

[Control panel buttons](#)

Clean the print cartridges

Use this feature when the self-test report shows streaking, white lines through any of the lines of color or when a color is muddy after installing a print cartridge for the first time. Do not clean print cartridges unnecessarily, as this wastes ink and shortens the life of the ink nozzles.

To clean the print cartridges from the HP Photosmart Software

1. Load letter, A4, or legal unused plain white paper into the input tray.
2. In the HP Solution Center, click **Settings**, point to **Print Settings**, and then click **Printer Toolbox**.

 **NOTE:** You can also open the **Printer Toolbox** from the **Print Properties** dialog box. In the **Print Properties** dialog box, click the **Services** tab, and then click **Service this device**.

The **Printer Toolbox** appears.

3. Click the **Device Services** tab.
4. Click **Clean the Print Cartridges**.
5. Follow the prompts until you are satisfied with the quality of the output, and then click **Done**.

If copy or print quality still seems poor after you clean the print cartridges, try cleaning the print cartridge contacts before replacing the affected print cartridge.

Related topics

- [Clean the print cartridge contacts](#)
- [Replace the print cartridges](#)

Clean the print cartridge contacts

Clean the print cartridge contacts if you get repeated messages on your computer screen prompting you to check a print cartridge after you already have cleaned or aligned the print cartridges, or if the Check Print Cartridge light is blinking.

Before cleaning the print cartridge contacts, remove the print cartridge and verify that nothing is covering the print cartridge contacts, then reinstall the print cartridge. If you continue to get messages to check the print cartridges, clean the print cartridge contacts.

Make sure you have the following materials available:

- Dry foam rubber swabs, lint-free cloth, or any soft material that will not come apart or leave fibers.

 **TIP:** Coffee filters are lint-free and work well for cleaning print cartridges.

- Distilled, filtered, or bottled water (tap water might contain contaminants that can damage the print cartridges).

 **CAUTION:** Do **not** use platen cleaners or alcohol to clean the print cartridge contacts. These can damage the print cartridge or the HP All-in-One.

To clean the print cartridge contacts

1. Turn on the HP All-in-One and open the print cartridge door.
The print carriage moves to the center of the HP All-in-One.
2. Wait until the print carriage is idle and silent, and then unplug the power cord from the back of the HP All-in-One.
3. Lightly press down on the print cartridge to release it, and then pull it toward you out of the slot.

 **NOTE:** Do not remove both print cartridges at the same time. Remove and clean each print cartridge one at a time. Do not leave a print cartridge outside the HP All-in-One for more than 30 minutes.

4. Inspect the print cartridge contacts for ink and debris buildup.
5. Dip a clean foam rubber swab or lint-free cloth into distilled water, and squeeze any excess water from it.
6. Hold the print cartridge by its sides.
7. Clean only the copper-colored contacts. Allow the print cartridges to dry for approximately ten minutes before reinserting.

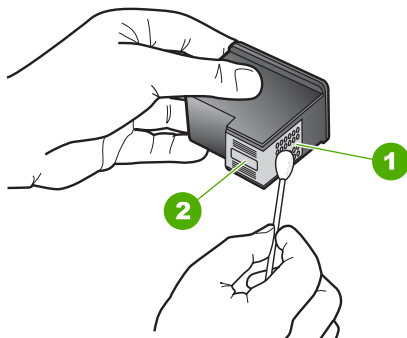

1	Copper-colored contacts
2	Ink nozzles (do not clean)

8. Slide the print cartridge back into the slot. Push the print cartridge forward until it clicks into place.
9. Repeat if necessary for the other print cartridge.
10. Gently close the print cartridge door and plug the power cord into the back of the HP All-in-One.

Related topics

- [Clean the area around the ink nozzles](#)
- [Replace the print cartridges](#)

Clean the area around the ink nozzles

If the HP All-in-One is used in a dusty environment, a small amount of debris might accumulate inside the device. This debris can include dust, hair, carpet, or clothing fibers.

When debris gets on the print cartridges, it can cause ink streaks and smudges on printed pages. Ink streaking can be corrected by cleaning around the ink nozzles as described here.

 **NOTE:** Clean the area around the ink nozzles only if you continue to see streaks and smudges on your printed pages after you have already cleaned the print cartridges by using the software you installed with the HP All-in-One.

Make sure you have the following materials available:

- Dry foam rubber swabs, lint-free cloth, or any soft material that will not come apart or leave fibers.

 **TIP:** Coffee filters are lint-free and work well for cleaning print cartridges.

- Distilled, filtered, or bottled water (tap water might contain contaminants that can damage the print cartridges).

 **CAUTION:** Do not touch the copper-colored contacts or ink nozzles. Touching these parts can result in clogs, ink failure, and bad electrical connections.

To clean the area around the ink nozzles

1. Turn on the HP All-in-One and open the print cartridge door.
The print carriage moves to the center of the HP All-in-One.
2. Wait until the print carriage is idle and silent, and then unplug the power cord from the back of the HP All-in-One.
3. Lightly press down on the print cartridge to release it, and then pull it toward you out of the slot.

 **NOTE:** Do not remove both print cartridges at the same time. Remove and clean each print cartridge one at a time. Do not leave a print cartridge outside the HP All-in-One for more than 30 minutes.

4. Place the print cartridge on a piece of paper with the ink nozzles facing up.
5. Lightly moisten a clean foam rubber swab with distilled water.

6. Clean the face and edges around the ink nozzle area with the swab, as shown below.

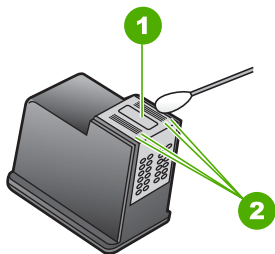

1	Nozzle plate (do not clean)
2	Face and edges around the ink nozzle area

△ **CAUTION:** Do **not** clean the nozzle plate.

7. Slide the print cartridge back into the slot. Push the print cartridge forward until it clicks into place.
8. Repeat if necessary for the other print cartridge.
9. Gently close the print cartridge door and plug the power cord into the back of the HP All-in-One.

Related topics

[Clean the print cartridges](#)

Remove ink from your skin and clothing

Follow these instructions to remove ink from your skin and clothing:

Surface	Remedy
Skin	Wash the area with an abrasive soap.
White fabric	Wash the fabric in <i>cold</i> water and use chlorine bleach.
Color fabric	Wash the fabric in <i>cold</i> water and use sudsy ammonia.

△ **CAUTION:** Always use cold water to remove ink from fabric. Warm or hot water can set the ink into the fabric.

11 Shop for printing supplies

You can order HP products, such as recommended types of paper and print cartridges, online from the HP Web site.

This section contains the following topics:

- [Order paper or other media](#)
- [Order print cartridges](#)
- [Order other supplies](#)

Order paper or other media

To order HP papers and other supplies, such as HP Premium Photo Papers or HP All-in-One Paper, go to www.hp.com/buy/supplies. If prompted, choose your country/region, follow the prompts to select your product, and then click one of the shopping links on the page.

Order print cartridges

For a list of print cartridge numbers, see the printed documentation that came with the HP All-in-One. You can also use the software that came with the HP All-in-One to find out the reorder number for all the print cartridges. You can order print cartridges online from the HP Web site. Additionally, you can contact a local HP reseller to find out the correct print cartridge reorder numbers for your device and purchase print cartridges.

To order HP papers and other supplies, go to www.hp.com/buy/supplies. If prompted, choose your country/region, follow the prompts to select your product, and then click one of the shopping links on the page.

 **NOTE:** At this time, some portions of the HP Web site are available in English only.

NOTE: Ordering print cartridges online is not supported in all countries/regions. If it is not supported in your country/region, contact a local HP reseller for information about purchasing print cartridges.

To order print cartridges through the HP Photosmart Software

1. In the HP Solution Center, click **Settings**, point to **Print Settings**, and then click **Printer Toolbox**.

 **NOTE:** You can also open the **Printer Toolbox** from the **Print Properties** dialog box. In the **Print Properties** dialog box, click the **Services** tab, and then click **Service this device**.

2. Click the **Estimated Ink Levels** tab.

3. Click **Print Cartridge Ordering Information**.

The print cartridge reorder numbers appear.

4. Click **Order Online**.

HP sends detailed printer information, including model number, serial number, and ink supply levels, to an authorized online reseller. The supplies you need are preselected; you can change quantities, add or remove items, and then check out.

Order other supplies

To order other supplies, such as HP Photosmart Software, a copy of the Setup Guide or other printed documentation, or other customer-replaceable parts, call the phone number for your country/region.

Country/region	Number for ordering
Asia Pacific (except for Japan)	65 272 5300
Australia	1300 721 147
Europe	+49 180 5 290220 (Germany) +44 870 606 9081 (U.K.)
New Zealand	0800 441 147
South Africa	+27 (0)11 8061030
U.S. and Canada	1-800-474-6836 (1-800-HP-INVENT)

To order supplies in other countries/regions not listed in the table, go to www.hp.com/support. If prompted, choose your country/region, and then click **Contact HP** for information on calling for technical support.

 **NOTE:** At this time, some portions of the HP Web site are available in English only.

12 Troubleshooting

This section contains the following topics:

- [Troubleshooting tips](#)
- [Hardware setup troubleshooting](#)
- [Software installation troubleshooting](#)
- [Print cartridge troubleshooting](#)
- [Print quality troubleshooting](#)
- [Print troubleshooting](#)
- [Copy troubleshooting](#)
- [Scan troubleshooting](#)
- [Errors](#)

Troubleshooting tips

This section contains the following topics:

- [Communication problems over a USB connection](#)
- [Information on paper](#)
- [Clear paper jams](#)
- [View the Readme file](#)

Communication problems over a USB connection

If the HP All-in-One and computer are not communicating with each other, try the following:

- Look at the **On** light located on the front of the HP All-in-One. If it is not lit, the HP All-in-One is turned off. Make sure the power cord is firmly connected to the HP All-in-One and plugged into a power outlet. Press the **On** button to turn on the HP All-in-One.
- Check the USB cable. If you are using an older cable, it might not be working properly. Try connecting it to another product to see if the USB cable works. If you experience problems, the USB cable might need to be replaced. Also verify that the cable does not exceed 3 meters (9.8 feet) in length.

- Check the connection from the HP All-in-One to your computer. Verify that the USB cable is securely plugged into the USB port on the back of the HP All-in-One. Make sure the other end of the USB cable is plugged into a USB port on your computer. After the cable is connected properly, turn the HP All-in-One off and then on again.

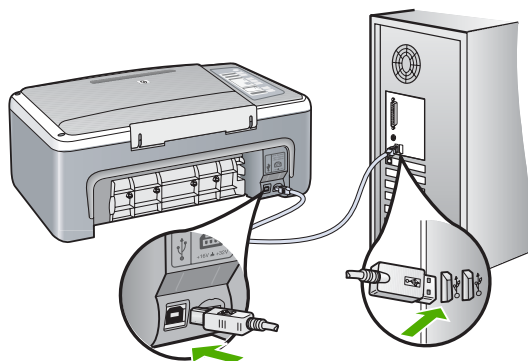

- If you are connecting the HP All-in-One through a USB hub, make sure the hub is turned on. If the hub is on, try connecting directly to your computer.
- Check other printers or scanners. You might need to disconnect older products from your computer.
- Try connecting the USB cable to another USB port on your computer. After you check the connections, try restarting your computer. Turn the HP All-in-One off and then on again.
- If necessary, remove the software you installed with the HP All-in-One and then install it again.

For more information, see:

- [Uninstall and reinstall the software](#)
- [Find more information](#)

Information on paper

The HP All-in-One is designed to work well with most paper types. Test a variety of paper types before buying a large quantity. Find a paper type that works well and is easy to purchase. HP Premium papers are designed for the best quality results. In addition, follow these tips:

- Do not use paper that is too thin, that has a slick texture, or that stretches easily. It can feed incorrectly through the paper path, causing paper jams.
- Store photo media in its original packaging inside a resealable plastic bag on a flat surface in a cool, dry place. When you are ready to print, remove only the paper you plan to use immediately. When you have finished printing, return any unused photo paper to the plastic bag.
- Do not leave unused photo paper in the input tray. The paper might start to curl, which might reduce the quality of your printouts. Curled paper can also cause paper jams.
- Always hold photo paper by the edges. Fingerprints on photo paper can reduce print quality.

- Do not use paper that is heavily textured. It can cause graphics or text to print improperly.
- Do not combine different paper types and paper sizes in the input tray; the entire stack of paper in the input tray must be the same size and type.
- Store printed photos under glass or in a storage book to prevent bleeding over time from high humidity. Use HP Premium Plus photo paper for maximum performance.

Clear paper jams

If the HP All-in-One has a paper jam, check the rear door.



To clear a paper jam from the rear door

1. Press in the tab on the left side of the rear door to release the door. Remove the door by pulling it away from the HP All-in-One.

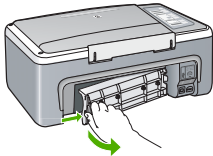

2. Gently pull the paper out of the rollers.

△ **CAUTION:** If the paper tears when you are removing it from the rollers, check the rollers and wheels for torn pieces of paper that might be remaining inside the device. If you do not remove all the pieces of paper from the HP All-in-One, more paper jams are likely to occur.

3. Replace the rear door. Gently push the door forward until it snaps into place.
4. Press **Resume** to continue the current job.

View the Readme file

You might want to refer to the Readme file for information on system requirements and possible installation problems.

You can access the Readme file by clicking **Start**, pointing to **Programs** or **All Programs**, pointing to **HP**, pointing to **Deskjet F4100 All-in-One series**, and then clicking **Readme**.

Hardware setup troubleshooting

This section contains hardware troubleshooting information for the HP All-in-One.

Many issues are caused when the HP All-in-One is connected to the computer using a USB cable before the HP All-in-One software is installed on the computer. If you

connected the HP All-in-One to your computer before the software installation screen prompts you to do so, you must follow these steps:

Troubleshooting common setup issues

1. Disconnect the USB cable from the computer.
2. Uninstall the software (if you have already installed it).
3. Restart your computer.
4. Turn off the HP All-in-One, wait one minute, then restart it.
5. Reinstall the HP All-in-One software.

△ **CAUTION:** Do not connect the USB cable to the computer until prompted by the software installation screen.

This section contains the following topics:

- [The HP All-in-One will not turn on](#)
- [I connected the USB cable, but I am having problems using the HP All-in-One with my computer](#)
- [The HP All-in-One does not print](#)

The HP All-in-One will not turn on

Cause: The HP All-in-One is not properly connected to a power supply.

Solution:

- Make sure the power cord is firmly connected to both the HP All-in-One and the power adapter. Plug the power cord into a grounded power outlet, surge protector, or power strip.

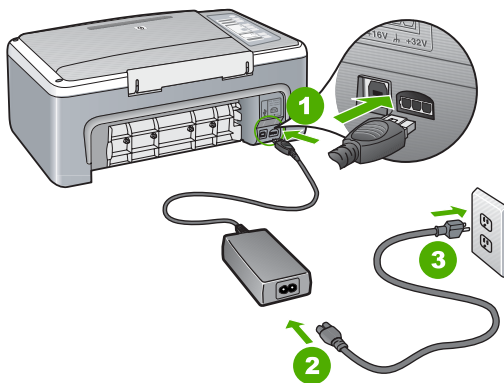

1	Power connection
2	Power cord and adapter
3	Grounded power outlet

- If you are using a power strip, make sure the power strip is on. Or, try plugging the HP All-in-One directly into a grounded power outlet.
- Test the power outlet to make sure it is working. Plug in an appliance that you know works, and see if the appliance has power. If not, then there might be a problem with the power outlet.
- If you plugged the HP All-in-One into a switched outlet, make sure the switch is on. If it is switched to on but still does not work, then there might be a problem with the power outlet.

Cause: You pressed the **On** button too quickly.

Solution: The HP All-in-One might not respond if you press the **On** button too quickly. Press the **On** button once. It might take a few minutes for the HP All-in-One to turn on. If you press the **On** button again during this time, you might turn the device off.

△ **CAUTION:** If the HP All-in-One still does not turn on, it might have a mechanical failure. Unplug the HP All-in-One from the power outlet and contact HP. Go to: www.hp.com/support. If prompted, choose your country/region, and then click **Contact HP** for information on calling for technical support.

I connected the USB cable, but I am having problems using the HP All-in-One with my computer

Cause: The USB cable was connected before the software was installed. Connecting the USB cable before prompted can cause errors.

Solution: You must first install the software that came with the HP All-in-One before connecting the USB cable. During installation, do not plug in the USB cable until prompted by the onscreen instructions.

Once you have installed the software, connecting your computer to the HP All-in-One with a USB cable is straightforward. Simply plug one end of the USB cable into the back of your computer and the other into the back of the HP All-in-One. You can connect to any USB port on the back of your computer.

If you installed the software, uninstall it and then reinstall it, connecting the USB cable only when prompted.

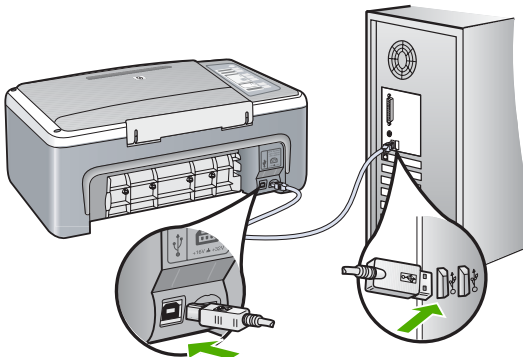

For more information on installing the software and connecting the USB cable, see the Setup Guide that came with the HP All-in-One.

The HP All-in-One does not print

Cause: The HP All-in-One and computer are not communicating with each other.

Solution:

- Look at the **On** light located on the front of the HP All-in-One. If it is not lit, the HP All-in-One is turned off. Make sure the power cord is firmly connected to the HP All-in-One and plugged into a power outlet. Press the **On** button to turn on the HP All-in-One.
- Make sure the print cartridges are installed.
- Make sure you have paper loaded in the input tray.
- Check that the HP All-in-One does not have a paper jam.
- Check that the print carriage is not jammed.
Open the print cartridge door to access the print carriage area. Remove any objects that are blocking the print carriage, including any packing materials. Turn the HP All-in-One off and then turn it on again.
- Check that the HP All-in-One print queue is not paused. If it is, choose the appropriate setting to resume printing. For more information about accessing the print queue, see the documentation that came with the operating system installed on your computer.
- Check the USB cable. If you are using an older cable, it might not be working properly. Try connecting it to another product to see if the USB cable works. If you experience problems, the USB cable might need to be replaced. Also verify that the cable does not exceed 3 meters (9.8 feet) in length.
- Make sure your computer is USB ready and that you are using a supported operating system. For more information, see the Readme file.
- Check the connection from the HP All-in-One to your computer. Verify that the USB cable is securely plugged into the USB port on the back of the HP All-in-One. Make sure the other end of the USB cable is plugged into a USB port on your computer. After the cable is connected properly, turn the HP All-in-One off and then on again.

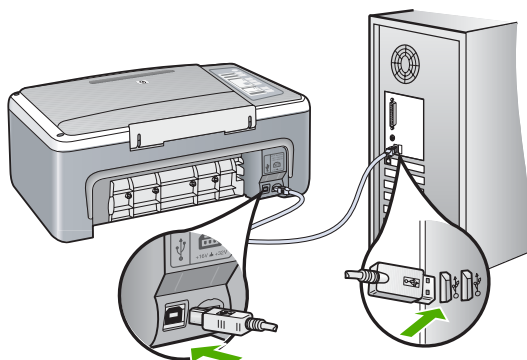

- If you are connecting the HP All-in-One through a USB hub, make sure the hub is turned on. If the hub is on, try connecting directly to your computer.
- Check other printers or scanners. You might need to disconnect older products from your computer.
- Try connecting the USB cable to another USB port on your computer. After you check the connections, try restarting your computer. Turn the HP All-in-One off and then on again.
- After you check the connections, try restarting your computer. Turn the HP All-in-One off and then on again.
- If necessary, remove and then install the software you installed with the HP All-in-One again. For more information, see [Uninstall and reinstall the software](#).

For more information on setting up the HP All-in-One and connecting it to your computer, see the Setup Guide that came with the HP All-in-One.

Software installation troubleshooting

Use this section to solve any problems you might encounter while setting up the HP All-in-One software.

This section contains the following topics:

- [When I insert the CD-ROM into my computer's CD-ROM drive, nothing happens](#)
- [The minimum system checks screen appears](#)
- [A red X appears on the USB connect prompt](#)
- [I received a message that an unknown error has occurred](#)
- [Some of the buttons are missing in the HP Solution Center](#)
- [The registration screen does not appear](#)
- [The HP Digital Imaging Monitor does not appear in the system tray](#)
- [Missing HP Photosmart Software](#)
- [Uninstall and reinstall the software](#)

When I insert the CD-ROM into my computer's CD-ROM drive, nothing happens

Cause: The installation failed to run automatically.

Solution: If the installation does not run automatically, you can start it manually.

To start the installation from a Windows computer

1. From the Windows **Start** menu, click **Run**.
2. In the **Run** dialog box, enter **d:\setup.exe**, and then click **OK**.
If your CD-ROM drive is not assigned to drive letter D, enter the appropriate drive letter.

The minimum system checks screen appears

Cause: Your system does not meet the minimum requirements to install the software.

Solution: Click **Details** to see what the specific problem is, and then correct the problem before attempting to install the software.

A red X appears on the USB connect prompt

Cause: Normally, a green check appears indicating that the plug and play is successful. A red X indicates that the plug and play failed.

Solution:

To retry the plug and play

1. Verify that the control panel overlay is firmly attached, unplug the HP All-in-One power cord, and then plug it in again.
2. Verify that the USB cable and power cord are plugged in.

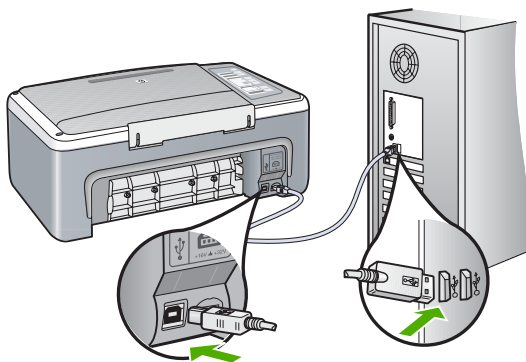

3. Click **Retry** to retry the plug and play setup. If this does not work, continue to the next step.
 4. Verify that the USB cable is set up properly as follows:
 - Unplug the USB cable and plug it in again.
 - Do not attach the USB cable to a keyboard or non-powered hub.
 - Verify that the USB cable is 3 meters (9.8 feet) or less in length.
 - If you have several USB devices attached to your computer, you might want to unplug the other devices during the installation.
 5. Continue with the installation and restart the computer when prompted.
 6. If you are using a Windows computer, open the HP Solution Center and check for the appropriate buttons for your device (such as **Make Copies**). If the buttons do not appear, remove the software and then reinstall it.
- For more information, see:

[Uninstall and reinstall the software](#)

I received a message that an unknown error has occurred

Cause: The source of the error is unknown.

Solution: Try to continue with the installation. If that does not work, stop and then restart the installation, and follow the directions on the screen. If an error occurs, you might need to uninstall and then reinstall the software. Do not simply delete the HP All-in-One application files from your computer. Make sure to remove them properly using the uninstall utility provided when you installed the software that came with the HP All-in-One.

For more information, see:

[Uninstall and reinstall the software](#)

Some of the buttons are missing in the HP Solution Center

Cause: The installation might not be complete.

Solution: If the appropriate buttons for your device (such as **Make Copies**) do not appear, your installation might not be complete, and you might need to uninstall and then reinstall the software. Do not simply delete the HP All-in-One application files from your hard drive. Make sure to remove them properly using the uninstall utility provided in the HP All-in-One program group.

For more information, see:

[Uninstall and reinstall the software](#)

The registration screen does not appear

Cause: The registration screen did not launch automatically.

Solution: You can access the registration (Sign up now) screen from the Windows taskbar by clicking **Start**, pointing to **Programs** or **All Programs**, **HP, Deskjet F4100 All-In-One series**, and then clicking **Product Registration**.

The HP Digital Imaging Monitor does not appear in the system tray

Cause: The installation might not be complete.

Solution: If the **HP Digital Imaging Monitor** does not appear in the system tray (normally located at the lower-right corner of the desktop), start the HP Solution Center.

If the appropriate buttons for your device (such as **Make Copies**) do not appear, your installation might not be complete, and you might need to uninstall and then reinstall the software. Do not simply delete the HP All-in-One application files from your hard drive. Make sure to remove them properly using the uninstall utility provided in the HP All-in-One program group.

For more information, see:

[Uninstall and reinstall the software](#)

Missing HP Photosmart Software

Cause: The HP Photosmart Software is not installed.

Solution: Install the HP Photosmart Software that came with the HP All-in-One. If it is installed, restart your computer.

To install the HP Photosmart Software

1. Insert the HP All-in-One CD-ROM into your computer's CD-ROM drive and then start the Setup program.
2. When prompted, click **Install More Software** to install the HP Photosmart Software.
3. Follow the onscreen instructions and the instructions provided in the Setup Guide that came with the HP All-in-One.

Cause: The HP All-in-One is turned off.

Solution: Turn the HP All-in-One on.

Cause: The computer is turned off.

Solution: Turn the computer on.

Cause: The HP All-in-One is not properly connected to the computer.

Solution: Check the connection from the HP All-in-One to your computer. Verify that the USB cable is securely plugged into the USB port on the back of the HP All-in-One. Make sure the other end of the USB cable is plugged into a USB port on your computer. After the cable is connected properly, turn the HP All-in-One off and then on again.

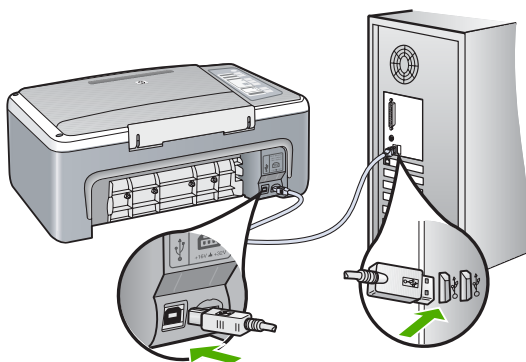

For more information on setting up the HP All-in-One and connecting it to your computer, see the Setup Guide that came with the HP All-in-One.

Uninstall and reinstall the software

If your installation is incomplete, or if you connected the USB cable to the computer before prompted by the software installation screen, you might need to uninstall and then reinstall the software. Do not simply delete the HP All-in-One application files from your

computer. Make sure to remove them properly using the uninstall utility provided when you installed the software that came with the HP All-in-One.

To uninstall from a Windows computer, method 1

1. Disconnect the HP All-in-One from your computer. Do not connect the HP All-in-One to your computer until after you have reinstalled the software.
2. On the Windows taskbar, click **Start, Programs** or **All Programs, HP, Deskjet F4100 All-In-One series, Uninstall**.
3. Follow the onscreen instructions.
4. If you are asked whether you would like to remove shared files, click **No**. Other programs that use these files might not work properly if the files are deleted.
5. Restart your computer.

 **NOTE:** It is important that you disconnect the HP All-in-One before restarting your computer. Do not connect the HP All-in-One to your computer until after you have reinstalled the software.

6. To reinstall the software, insert the HP All-in-One CD-ROM into your computer's CD-ROM drive, and follow the onscreen instructions and the instructions provided in the Setup Guide that came with the HP All-in-One.
7. After the software is installed, connect the HP All-in-One to your computer.
8. Press the **On** button to turn the HP All-in-One on. After connecting and turning on the HP All-in-One, you might have to wait several minutes for all of the Plug and Play events to complete.
9. Follow the onscreen instructions.

To uninstall from a Windows computer, method 2

 **NOTE:** Use this method if **Uninstall** is not available in the Windows Start menu.

1. On the Windows taskbar, click **Start, Settings, Control Panel**.
2. Double-click **Add/Remove Programs**.
3. Select **HP Deskjet All-In-One Driver Software**, and then click **Change/Remove**. Follow the onscreen instructions.
4. Disconnect the HP All-in-One from your computer.
5. Restart your computer.

 **NOTE:** It is important that you disconnect the HP All-in-One before restarting your computer. Do not connect the HP All-in-One to your computer until after you have reinstalled the software.

6. Insert the HP All-in-One CD-ROM into your computer's CD-ROM drive and then start the Setup program.
7. Follow the onscreen instructions and the instructions provided in the Setup Guide that came with the HP All-in-One.

To uninstall from a Windows computer, method 3

 **NOTE:** Use this method if **Uninstall** is not available in the Windows Start menu.

1. Insert the HP All-in-One CD-ROM into your computer's CD-ROM drive and then start the Setup program.
2. Disconnect the HP All-in-One from your computer.
3. Select **Uninstall** and follow the onscreen directions.
4. Restart your computer.



NOTE: It is important that you disconnect the HP All-in-One before restarting your computer. Do not connect the HP All-in-One to your computer until after you have reinstalled the software.

5. Start the Setup program for the HP All-in-One again.
6. Select **Install**.
7. Follow the onscreen instructions and the instructions provided in the Setup Guide that came with the HP All-in-One.

When the software installation is complete, the **HP Digital Imaging Monitor** icon appears in the Windows system tray.

To verify that the software is properly installed, double-click the HP Solution Center icon on the desktop. If the HP Solution Center shows the essential icons (**Scan Picture** and **Scan Document**), the software has been properly installed.

Print cartridge troubleshooting

If you are experiencing problems with printing, you might have a problem with one of the print cartridges. If you receive an error message about the print cartridges, see [Print cartridge messages](#) for more information.

Try the following:

To troubleshoot print cartridges

1. Remove the black print cartridge from the slot on the right. Do not touch the ink nozzles or the copper-colored contacts. Check for possible damage to the copper-colored contacts or ink nozzles.
Make sure the plastic tape has been removed. If it is still covering the ink nozzles, gently remove the plastic tape by using the pink pull tab.
2. Reinsert the print cartridge by sliding it forward into the slot. Then push the print cartridge forward until it clicks into the socket.



3. Repeat steps 1 and 2 for the tri-color print cartridge on the left side.

4. If the problem persists, print a self-test report to determine if there is a problem with the print cartridges.
This report provides useful information about your print cartridges, including status information.
5. If the self-test report shows a problem, clean the print cartridges.
6. Clean only the copper-colored contacts. Allow the print cartridges to dry for approximately ten minutes before reinserting.

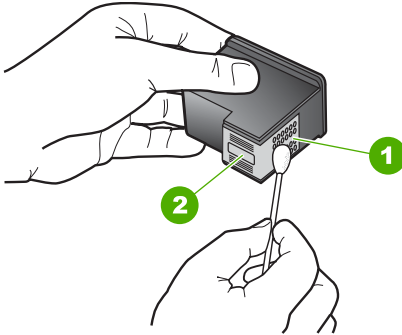

1	Copper-colored contacts
2	Ink nozzles (do not clean)

7. If you are still experiencing problems with printing, determine which print cartridge is experiencing the problem and replace it.

To check the ink levels from the HP Photosmart Software

1. In the HP Solution Center, click **Settings**, point to **Print Settings**, and then click **Printer Toolbox**.

 **NOTE:** You can also open the **Printer Toolbox** from the **Print Properties** dialog box. In the **Print Properties** dialog box, click the **Services** tab, and then click **Service this device**.

The **Printer Toolbox** appears.

2. Click the **Estimated Ink Level** tab.
The estimated ink levels for the print cartridges appear.

To print a self-test report

1. Load letter or A4 unused plain white paper into the input tray.
2. Press and hold the **Cancel** button and then press the **Start Copy Color** button. The HP All-in-One prints a self-test report, which might indicate the source of the printing problem. A sample of the ink test area of the report is shown below.

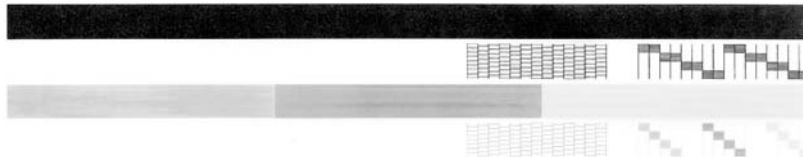

3. Make sure the test patterns show a complete grid and the thick color lines are complete.
 - If more than a few lines in a pattern are broken, this might indicate a problem with the nozzles. You might need to clean the print cartridges.
 - If the black line is missing, faded, streaked, or shows lines, this might indicate a problem with the black print cartridge in the right slot.
 - If any of the color lines are missing, faded, streaked, or show lines, this might indicate a problem with the tri-color print cartridge in the left slot.

To clean the print cartridges from the HP Photosmart Software

1. Load letter, A4, or legal unused plain white paper into the input tray.
2. In the HP Solution Center, click **Settings**, point to **Print Settings**, and then click **Printer Toolbox**.



NOTE: You can also open the **Printer Toolbox** from the **Print Properties** dialog box. In the **Print Properties** dialog box, click the **Services** tab, and then click **Service this device**.

The **Printer Toolbox** appears.

3. Click the **Device Services** tab.
4. Click **Clean the Print Cartridges**.
5. Follow the prompts until you are satisfied with the quality of the output, and then click **Done**.

If copy or print quality still seems poor after you clean the print cartridges, try cleaning the print cartridge contacts before replacing the affected print cartridge.

To clean the print cartridge contacts

1. Turn on the HP All-in-One and open the print cartridge door. The print carriage moves to the center of the HP All-in-One.
2. Wait until the print carriage is idle and silent, and then unplug the power cord from the back of the HP All-in-One.

3. Lightly press down on the print cartridge to release it, and then pull it toward you out of the slot.

 **NOTE:** Do not remove both print cartridges at the same time. Remove and clean each print cartridge one at a time. Do not leave a print cartridge outside the HP All-in-One for more than 30 minutes.

4. Inspect the print cartridge contacts for ink and debris buildup.
5. Dip a clean foam rubber swab or lint-free cloth into distilled water, and squeeze any excess water from it.
6. Hold the print cartridge by its sides.
7. Clean only the copper-colored contacts. Allow the print cartridges to dry for approximately ten minutes before reinserting.

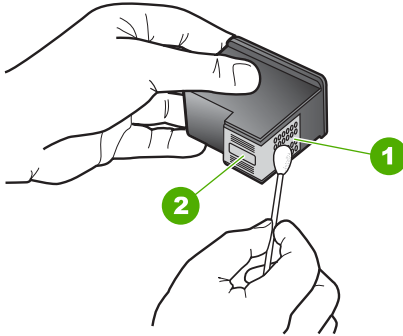

1	Copper-colored contacts
2	Ink nozzles (do not clean)

8. Slide the print cartridge back into the slot. Push the print cartridge forward until it clicks into place.
9. Repeat if necessary for the other print cartridge.
10. Gently close the print cartridge door and plug the power cord into the back of the HP All-in-One.

To replace the print cartridges

1. Make sure the HP All-in-One is on.

△ **CAUTION:** If the HP All-in-One is off when you open the print cartridge door to access the print cartridges, the HP All-in-One will not release the cartridges for changing. You might damage the HP All-in-One if the print cartridges are not docked safely when you try to remove them.

2. Open the print cartridge door.

The print carriage should move to the center of the HP All-in-One. If the print carriage does not move to the center, turn the HP All-in-One off, and then on.

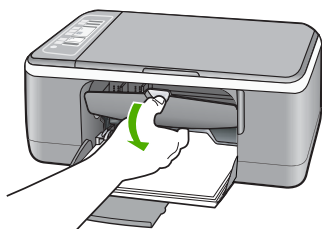

3. Wait until the print carriage is idle and silent, and then lightly press down on a print cartridge to release it.

If you are replacing the tri-color print cartridge, remove the print cartridge from the slot on the left.

If you are replacing the black or photo print cartridge, remove the print cartridge from the slot on the right.

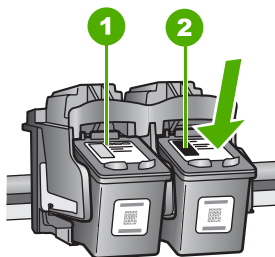

- | | |
|---|---|
| 1 | Print cartridge slot for the tri-color print cartridge |
| 2 | Print cartridge slot for the black and photo print cartridges |

4. Pull the print cartridge toward you out of its slot.

5. If you are removing the black print cartridge in order to install the photo print cartridge, store the black print cartridge in the print cartridge protector or an airtight plastic container.

If you are removing the print cartridge because it is low or out of ink, recycle the print cartridge. The HP Inkjet Supplies Recycling Program is available in many countries/regions, and lets you recycle used print cartridges free of charge. For more information, go to the following Web site:

www.hp.com/hpinfo/globalcitizenship/environment/recycle/inkjet.html

6. Remove the new print cartridge from its packaging, being careful to touch only the black plastic. Gently remove the plastic tape using the pink pull tab.

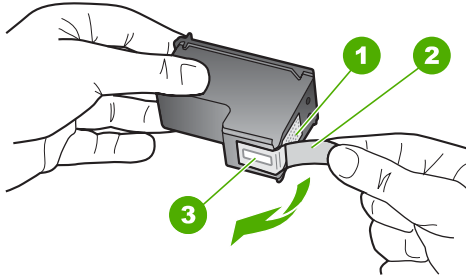

1	Copper-colored contacts
2	Plastic tape with pink pull tab (must be removed before installing)
3	Ink nozzles under tape

⚠ CAUTION: Do not touch the copper-colored contacts or ink nozzles. Touching these parts can result in clogs, ink failure, and bad electrical connections.



7. Slide the new print cartridge forward into the empty slot. Then gently push on the upper part of the print cartridge forward until it clicks into the socket.
If you are installing the tri-color print cartridge, slide it into the left slot.
If you are installing a black or photo print cartridge, slide it into the right slot.

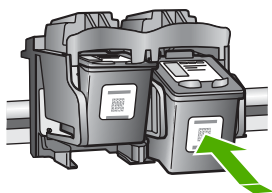

8. Close the print cartridge door.

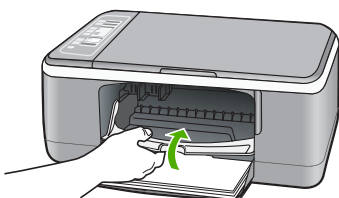

9. If the print cartridge alignment sheet prints, load it on the left front corner of the glass with the top of the page to the left.

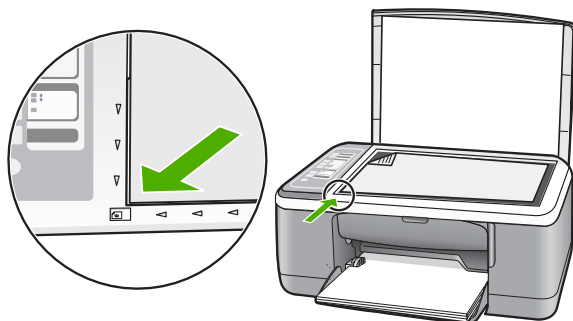

10. Press the **Scan** button.
The HP All-in-One aligns the print cartridges. Recycle or discard the print cartridge alignment sheet.

Information on print cartridges

For best results, use HP print cartridges. The following tips help maintain HP print cartridges and ensure consistent print quality.

- Keep all print cartridges in the original sealed packages until they are needed.
- Store print cartridges at room temperature (15.6°-26.6° C or 60°-78° F).
- Do not reattach the protective tape once it has been removed from the print cartridge. Reattaching the plastic tape might damage the print cartridge. Place the print cartridge in the HP All-in-One immediately after removing the plastic tape. If this is not possible, store it in a print cartridge protector or airtight plastic container.
- HP recommends that you do not remove the print cartridges from the HP All-in-One until you have replacement print cartridges available to install.
- Turn off the HP All-in-One from the control panel. Do not turn off the device by turning off a power strip or unplugging the power cord from the HP All-in-One. If you improperly turn off the HP All-in-One, the print carriage does not return to the correct position and the print cartridges can dry out.
- Do not open the print cartridge door unless necessary. This exposes the print cartridges to air, which reduces the life of the print cartridges.

 **NOTE:** If you leave the print cartridge door open for a long period of time, the HP All-in-One will recap the print cartridges to protect them from exposure to air.

- Clean the print cartridges when you notice a significant decrease in print quality.

 **TIP:** You might notice a decrease in print quality if the print cartridges have not been used for a long time.

- Do not clean the print cartridges unnecessarily. This wastes ink and shortens the life of the cartridges.
- Handle print cartridges carefully. Dropping, jarring, or rough handling during installation can cause temporary printing problems. If print quality is poor right after cartridge installation, allow half an hour for the print cartridge to recover.

For more information, see:

[Print cartridge troubleshooting](#)

Print quality troubleshooting

If you are having problems with print quality, try the solutions in this section and observe the following guidelines:

- Replace refilled or empty cartridges.
- Check the device settings to make sure that the print mode and paper selection is correct for the paper and the task.

For more information, see [Set the paper type for printing](#) and [Choose papers for printing and copying](#).

- Print and evaluate a self-test.
For more information, see [Print a self-test report](#).
If the self-test shows a defect, try the following:
 - Clean the print cartridges automatically. For more information, see [Clean the print cartridges](#).
 - If you are missing lines when you print, clean the electrical contacts. For more information, see [Clean the area around the ink nozzles](#).
 - Replace the print cartridge. For more information, see [Replace the print cartridges](#).
- If the self-test does not show a problem, investigate other causes, such as the image file or software program.

For additional print cartridge troubleshooting, visit the HP Web site at www.hp.com/support.

This section contains the following topics:

- [Ink is bleeding or smearing](#)
- [Ink is not filling the text or graphics completely](#)
- [The text edges are jagged](#)
- [The printout has a horizontal band of distortion near the bottom of the page](#)
- [Printouts or copies seem blurry or fuzzy](#)
- [Printouts or copies have vertical streaks](#)
- [Paper is not picked up from the input tray](#)
- [Printouts or copies are slanted or skewed](#)

Ink is bleeding or smearing

Cause: The paper type is not suitable for the HP All-in-One.

Solution: Use HP Premium Papers or any other paper type that is appropriate for the HP All-in-One.

Cause: The print cartridges need to be cleaned.

Solution: Check the estimated ink levels remaining in the print cartridges. If the print cartridges are low or out of ink, you might need to replace the print cartridges.

If there is ink remaining in the print cartridges, but you are still noticing a problem, print a self-test report to determine if there is a problem with the print cartridges. If the self-test report shows a problem, clean the print cartridges. If the problem persists, you might need to replace the print cartridges.

For more information, see:

- [Print cartridge troubleshooting](#)
 - [Print a self-test report](#)
-

Cause: The paper is too close to the print cartridge during printing.

Solution: If the paper is too close to the print cartridge during printing, the ink might be smeared. This can happen if the paper is raised, wrinkled, or very thick, such as

a mailing envelope. Make sure the paper lays flat in the input tray and is not too wrinkled.

Ink is not filling the text or graphics completely

Cause: The print cartridges need to be cleaned or might be out of ink.

Solution: Check the estimated ink levels remaining in the print cartridges. If the print cartridges are low or out of ink, you might need to replace the print cartridges. If there is ink remaining in the print cartridges, but you are still noticing a problem, print a self-test report to determine if there is a problem with the print cartridges. If the self-test report shows a problem, clean the print cartridges. If the problem persists, you might need to replace the print cartridges.

For more information on print cartridges, see [Print cartridge troubleshooting](#).

Cause: The copy or print paper type setting is incorrect.

Solution: Change the paper type setting to match the type of paper loaded in the input tray.

For more information, see:

- [Set the paper type for printing](#)
 - [Set the copy paper type](#)
-

Cause: The print quality or copy setting on the HP All-in-One is set too low.

Solution: Check the quality setting. Use a higher quality setting to increase the amount of ink used for printing.

For more information, see:

- [Change the print speed or quality](#)
 - [Change copy speed](#)
-

The text edges are jagged

Cause: The font is a custom size.

Solution: Some software applications offer custom fonts that have jagged edges when enlarged or printed. Also, if you want to print bitmapped text, it might have jagged edges when enlarged or printed.

Use TrueType or OpenType fonts to ensure that the HP All-in-One is able to print smooth fonts. When selecting a font, look for the TrueType or OpenType icon.

The printout has a horizontal band of distortion near the bottom of the page

Cause: Your photo image has light blue, gray, or brown hues that print near the bottom of the page.

Solution: Load high-quality paper in the input tray and print the image with a high print quality setting, such as **Best**, **Maximum dpi**, or **High Resolution**. Always make sure the paper you are printing on is flat. For best results when printing images, use HP Premium Plus Photo Paper.

If the problem persists, use the software you installed with the HP All-in-One or another software application to rotate your image 180 degrees so that the light blue, gray, or brown hues in your image do not print at the bottom of the page. Print the image using six-ink printing. To do so, install the photo print cartridge in place of the black print cartridge. With the photo print cartridge and the tri-color print cartridge installed, you have a six-ink system, which provides enhanced quality photos.

For more information, see:

- [Information on paper](#)
 - [Print cartridge troubleshooting](#)
-

Printouts or copies seem blurry or fuzzy

Cause: The paper type is not suitable for the HP All-in-One.

Solution: If the paper you are using is too fibrous, the ink applied by the HP All-in-One might not fully cover the surface of the paper. Use HP Premium Papers or any other paper type that is appropriate for the HP All-in-One.

For more information, see:

[Information on paper](#)

Cause: The copy or print paper type setting is incorrect.

Solution: Change the paper type setting to match the type of paper loaded in the input tray.

For more information, see:

- [Set the paper type for printing](#)
 - [Set the copy paper type](#)
-

Cause: The print quality or copy setting on the HP All-in-One is set too low.

Solution: Check the quality setting. Use a higher quality setting to increase the amount of ink used for printing.

For more information, see:

- [Change the print speed or quality](#)
 - [Change copy speed](#)
-

Cause: You are printing on the wrong side of the paper.

Solution: Load paper with the side you want to print on facing down. For example, if you are loading glossy photo paper, load the paper with the glossy side down.

Printouts or copies have vertical streaks

Cause: The paper type is not suitable for the HP All-in-One.

Solution: If the paper you are using is too fibrous, the ink applied by the HP All-in-One might not fully cover the surface of the paper. Use HP Premium Papers or any other paper type that is appropriate for the HP All-in-One.

For more information, see:

[Information on paper](#)

Paper is not picked up from the input tray

Cause: There is not enough paper in the input tray.

Solution: If the HP All-in-One is out of paper or there are only a few sheets remaining, load more paper in the input tray. If there is paper in the input tray, remove the paper, tap the stack of paper against a flat surface, and reload the paper into the input tray. To continue your print job, press the **Resume** button on the control panel of the HP All-in-One.

For more information, see:

[Load full-size paper](#)

Printouts or copies are slanted or skewed

Cause: The paper is not feeding properly or is loaded incorrectly.

Solution: Make sure the paper is loaded correctly.

For more information, see:

[Load full-size paper](#)

Cause: More than one type of paper is loaded in the input tray.

Solution: Load only one type of paper at a time.

Print troubleshooting

Use this section to solve these printing problems:

- [Envelopes print incorrectly](#)
- [Borderless printing produces unexpected results](#)
- [The HP All-in-One is not responding](#)
- [The HP All-in-One prints meaningless characters](#)
- [Nothing happens when I try to print](#)
- [The pages in my document came out in the wrong order](#)
- [The margins are not printing as expected](#)
- [Text or graphics are cut off at the edge of the page](#)

- [A blank page came out while printing](#)
- [Ink is spraying the inside of the HP All-in-One when I print a photo](#)

Envelopes print incorrectly

Cause: A stack of envelopes is loaded incorrectly.

Solution: Remove all paper from the input tray. Load a stack of envelopes in the input tray, with the envelope flaps facing up and on the left.



NOTE: To avoid paper jams, tuck the flaps inside the envelopes.

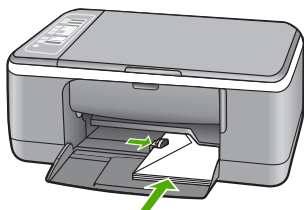

Cause: The wrong type of envelope is loaded.

Solution: Do not use shiny or embossed envelopes or envelopes that have clasps or windows.

Borderless printing produces unexpected results

Cause: Printing a borderless image from a non-HP software application produces unexpected results.

Solution: Try printing the image from the photo imaging software that came with the HP All-in-One.

Cause: Use of inappropriate media.

Solution: To print a borderless image, use 10 x 15 cm (4 x 6 inch) HP Premium Plus Photo Papers with a tear-off tab. When you remove the tear-off tab, the printed image is borderless and extends to the edges of the paper.

For more information, see:

[Print a borderless image](#)

The HP All-in-One is not responding

Cause: The HP All-in-One is busy with another task.

Solution: If the HP All-in-One is performing another task such as copying or scanning, your print job will be delayed until the HP All-in-One completes the current task.

Some documents take a long time to print. If nothing has printed several minutes after you sent a print job to the HP All-in-One, check your computer to see if there are any messages.

Cause: The HP All-in-One has a paper jam.

Solution: Clear the paper jam.

For more information, see:

[Clear paper jams](#)

Cause: The HP All-in-One is out of paper.

Solution: Load paper in the input tray.

For more information, see:

[Load full-size paper](#)

Cause: The print carriage has stalled.

Solution: Turn the HP All-in-One off, remove any objects that are blocking the print carriage (including any packing materials), and then turn the HP All-in-One on again.

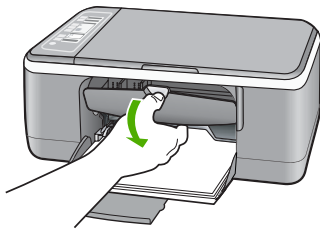

Cause: The computer is not communicating with the HP All-in-One.

Solution: If the HP All-in-One is not properly connected to the computer, communication errors can occur. Make sure the USB cable is connected to the HP All-in-One and the computer as shown below.

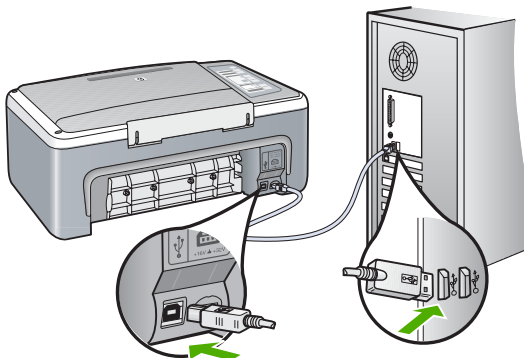

If the connections are secure, and nothing has printed several minutes after you sent a print job to the HP All-in-One, check the status of the HP All-in-One. In the HP Photosmart Software, click **Status**.

For more information, see:

[Communication problems over a USB connection](#)

Cause: The HP All-in-One is turned off.

Solution: Look at the **On** light located on the front of the HP All-in-One. If it is not lit, the HP All-in-One is turned off. Make sure the power cord is firmly connected to the HP All-in-One and plugged into a power outlet. Press the **On** button to turn on the HP All-in-One.

Cause: The HP All-in-One experienced an error.

Solution: Turn the HP All-in-One off, and then unplug the power cord. Plug the power cord back in, and then press the **On** button to turn on the HP All-in-One.

Cause: The status of the printer driver has changed.

Solution: The printer driver status might have changed to either **offline** or **stop printing**.

To check the printer driver status

1. In the HP Solution Center, click the device tab.
2. Click **Settings**.
3. Click **Status**.

If the status is **offline** or **stop printing**, change the status to **ready**.

Cause: A deleted print job is still in the queue.

Solution: A print job might remain in the queue after it has been cancelled. The cancelled print job jams the queue and prevents the next print job from printing.

From your computer, open the printer folder and see if the cancelled job remains in the print queue. Try to delete the job from the queue. If the print job remains in the queue, try one or both of the following:

- Disconnect the USB cable from the HP All-in-One, restart the computer, and then reconnect the USB cable to the HP All-in-One.
- Shut down the HP All-in-One, restart the computer, and then restart the HP All-in-One.

The HP All-in-One prints meaningless characters

Cause: The memory in the HP All-in-One is full.

Solution: Turn off the HP All-in-One and your computer for 60 seconds, then turn them both on and try printing again.

Cause: The document is corrupt.

Solution: Try printing another document from the same software application. If this works, then try printing a previously saved version of the document that is not corrupt.

Nothing happens when I try to print

Cause: The HP All-in-One is turned off.

Solution: Look at the **On** light located on the front of the HP All-in-One. If it is not lit, the HP All-in-One is turned off. Make sure the power cord is firmly connected to the HP All-in-One and plugged into a power outlet. Press the **On** button to turn on the HP All-in-One.

Cause: The HP All-in-One is busy with another task.

Solution: If the HP All-in-One is performing another task such as copying or scanning, your print job will be delayed until the HP All-in-One completes the current task.

Some documents take a long time to print. If nothing has printed several minutes after you sent a print job to the HP All-in-One, check your computer to see if there are any messages.

Cause: The HP All-in-One is not the selected printer.

Solution: Make sure the HP All-in-One is the selected printer in your software application.

 **TIP:** You can set the HP All-in-One as the default printer to ensure that the printer is automatically selected when you select **Print** in the **File** menu of your different software applications. For more information, see [Make the HP All-in-One the default printer.](#)

Cause: The computer is not communicating with the HP All-in-One.

Solution: If the HP All-in-One is not properly connected to the computer, communication errors can occur. Make sure the USB cable is connected to the HP All-in-One and the computer as shown below.

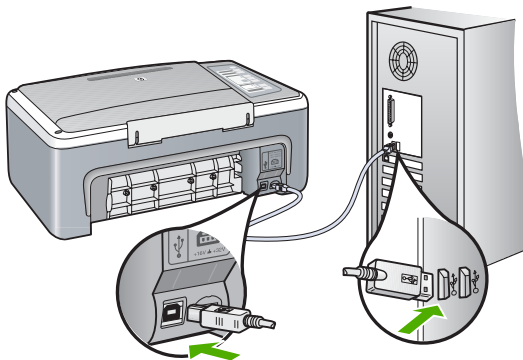

If the connections are secure, and nothing has printed several minutes after you sent a print job to the HP All-in-One, check the status of the HP All-in-One. In the HP Photosmart Software, click **Status**.

For more information, see:

[Communication problems over a USB connection](#)

Cause: The HP All-in-One has a paper jam.

Solution: Clear the paper jam.

For more information, see:

[Clear paper jams](#)

Cause: The print carriage has stalled.

Solution: Turn the HP All-in-One off, remove any objects that are blocking the print carriage (including any packing materials), and then turn the HP All-in-One on again.

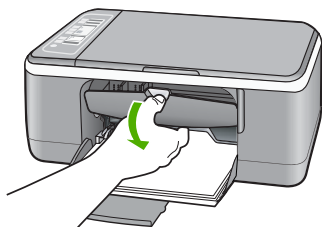

Cause: The HP All-in-One is out of paper.

Solution: Load paper in the input tray.

For more information, see:

[Load full-size paper](#)

The pages in my document came out in the wrong order

Cause: The print settings are set to print the first page of your document first. Because of the way the paper feeds through the HP All-in-One, this means the first page will be printed side up at the bottom of the stack.

Solution: Print the document in reverse order. When the document finishes printing, the pages will be in correct order.

For more information, see:

[Print a multiple-page document in reverse order](#)

The margins are not printing as expected

Cause: The margins are not set correctly in your software application.

Solution: Check the printer margins.

Make sure the margin settings for the document do not exceed the printable area of the HP All-in-One.

To check your margin settings

1. Preview your print job before sending it to the HP All-in-One.
2. Check the margins.
The HP All-in-One uses the margins you have set in your software application, as long as they are greater than the minimum margins the HP All-in-One supports.
3. Cancel the print job if the margins are not satisfactory, and then adjust the margins in your software application.

Cause: The paper size setting might not be set correctly for the project you are printing.

Solution: Verify that you have selected the proper paper size setting for your project. Make sure that you have loaded the correct paper size in the input tray.

For example, in some countries/regions you may need to specify A4 as the paper size if A (letter) is the default value.

For more information, see:

[Set the paper type for printing](#)

Cause: The paper guides are not positioned correctly.

Solution: Remove the stack of paper from the input tray, and then reload the paper. Make sure that you slide the paper-width guide inward until it stops at the edge of the paper.

For more information, see:

[Load paper](#)

Cause: A stack of envelopes is loaded incorrectly.

Solution: Remove all paper from the input tray. Load a stack of envelopes in the input tray, with the envelope flaps facing up and on the left.

 **NOTE:** To avoid paper jams, tuck the flaps inside the envelopes.

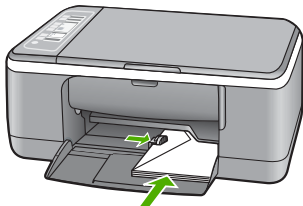

For more information, see:

[Load envelopes](#)

Text or graphics are cut off at the edge of the page

Cause: The margins are not set correctly in your software application.

Solution: Make sure the margin settings for the document do not exceed the printable area of the HP All-in-One.

To check your margin settings

1. Preview your print job before sending it to the HP All-in-One.
 2. Check the margins.
The HP All-in-One uses the margins you have set in your software application, as long as they are greater than the minimum margins the HP All-in-One supports.
 3. Cancel the print job if the margins are not satisfactory, and then adjust the margins in your software application.
-

Cause: The size of the document you are printing is larger than the paper loaded in the input tray.

Solution: Make sure the layout of the document you are trying to print fits on a paper size supported by the HP All-in-One.

To preview the print layout

1. Load the correct paper size into the input tray.
 2. Preview your print job before sending it to the HP All-in-One.
 3. Check the graphics in the document to make sure that the current size fits within the printable area of the HP All-in-One.
 4. Cancel the print job if the graphics do not fit in the printable area of the page.
-

 **TIP:** Some software applications allow you to scale the document to fit the paper size currently selected. Additionally, you can scale the size of a document from the print **Properties** dialog box.

Cause: The paper is loaded incorrectly.

Solution: If the paper is misfeeding, it could cause parts of the document to cut off.

Remove the stack of paper from the input tray, and then reload the paper. Make sure that you slide the paper-width guide inward until it stops at the edge of the paper.

For more information, see:

[Load full-size paper](#)

A blank page came out while printing

Cause: If you are printing black text, and a blank page comes out of the HP All-in-One, the black print cartridge might be empty.

Solution: Check the estimated ink levels remaining in the print cartridges. If the print cartridges are low or out of ink, you might need to replace the print cartridges. If there is ink remaining in the print cartridges, but you are still noticing a problem, print a self-test report to determine if there is a problem with the print cartridges. If the self-test report shows a problem, clean the print cartridges. If the problem persists, you might need to replace the print cartridges.

For more information on print cartridges, see [Print cartridge troubleshooting](#).

Cause: The document you are printing contains an additional blank page.

Solution: Open the document file in your software application and remove any extra pages or lines at the end of the document.

Cause: The HP All-in-One picked up two sheets of paper.

Solution: If the HP All-in-One has only a few sheets remaining, load more paper in the input tray. If there is plenty of paper in the input tray, remove the paper, tap the stack of paper against a flat surface, and reload the paper into the input tray.

For more information, see:

[Load full-size paper](#)

Cause: The protective plastic tape was only partially removed from the print cartridge.

Solution: Check each print cartridge. The tape might have been removed from the copper-colored contacts, but still might cover the ink nozzles. If the tape is still covering the ink nozzles, carefully remove the tape from the print cartridges. Do not touch the ink nozzles or the copper-colored contacts.

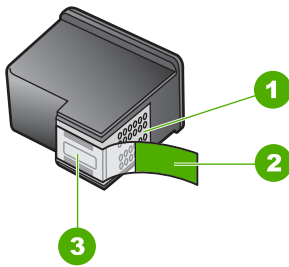

1	Copper-colored contacts
2	Plastic tape with pink pull tab (must be removed before installing)
3	Ink nozzles under tape



For more information, see:

[Replace the print cartridges](#)

Ink is spraying the inside of the HP All-in-One when I print a photo

Cause: The borderless print settings require photo paper to be loaded in the input tray. You are using the wrong paper type.

Solution: Make sure you load photo paper in the input tray before you print a borderless print job.

Copy troubleshooting

Use this section to solve these copy problems:

- [Nothing happens when I try to copy](#)
- [Parts of the original do not appear or are cut off](#)
- [The printout appears enlarged on the page](#)
- [The printout is blank](#)
- [A borderless copy has white space around the edges](#)

Nothing happens when I try to copy

Cause: The HP All-in-One is turned off.

Solution: Look at the **On** light located on the front of the HP All-in-One. If it is not lit, the HP All-in-One is turned off. Make sure the power cord is firmly connected to the HP All-in-One and plugged into a power outlet. Press the **On** button to turn on the HP All-in-One.

Cause: The original is placed incorrectly on the glass.

Solution: Place your original with the side you want to copy or scan face down on the left front corner of the glass.

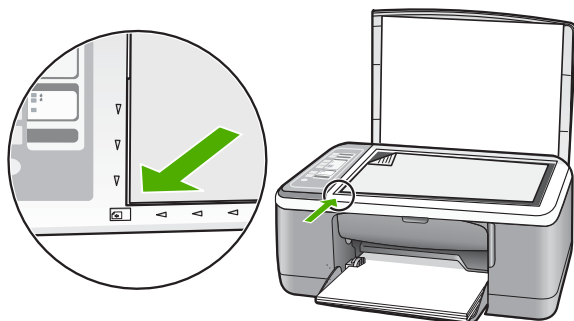

Cause: The HP All-in-One might be busy copying or printing.

Solution: Check the **On** light. If it is blinking, the HP All-in-One is busy.

Cause: The HP All-in-One does not recognize the paper type.

Solution: Do not use the HP All-in-One to copy onto envelopes or other papers the HP All-in-One does not support.

Cause: The HP All-in-One has a paper jam.

Solution: Clear the paper jam.

For more information, see:

[Clear paper jams](#)

Parts of the original do not appear or are cut off

Cause: The original is placed incorrectly on the glass.

Solution: Place your original with the side you want to copy or scan face down on the left front corner of the glass.

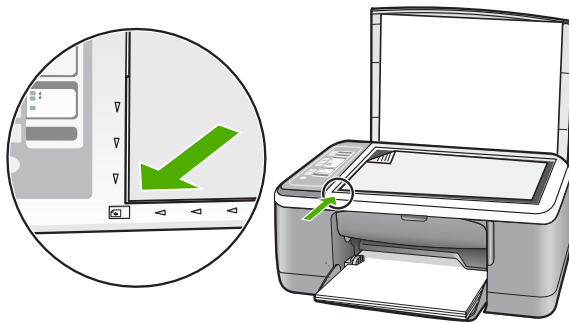

Cause: The scanner glass is dirty, causing the device to include an area in the copy that is larger than the document.

Solution: Clean the scanner glass and make sure that there are no foreign materials adhering to it.

For more information, see: [Clean the glass](#)

The printout appears enlarged on the page

Cause: The copied image does not cover the whole page.

Solution: Ensure that your Copy settings are chosen correctly. If the problem persists, debris might be stuck on the glass or on the back of the document lid. This can cause the HP All-in-One to detect only a portion of the image. Turn off the device,

unplug the power cord, and use a soft cloth to wipe the glass and the back of the document lid.

For more information, see:

- [Clean the lid backing](#)
- [Clean the glass](#)

The printout is blank

Cause: The original is placed incorrectly on the glass.

Solution: Place your original print side down on the left front corner of the glass.

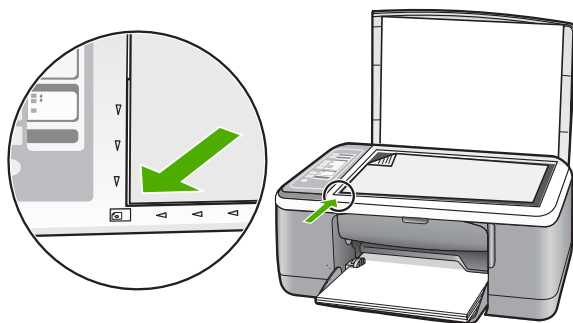

Cause: The print cartridges need to be cleaned or might be out of ink.

Solution: Check the estimated ink levels remaining in the print cartridges. If the print cartridges are low or out of ink, you might need to replace the print cartridges.

If there is ink remaining in the print cartridges, but you are still noticing a problem, print a self-test report to determine if there is a problem with the print cartridges. If the self-test report shows a problem, clean the print cartridges. If the problem persists, you might need to replace the print cartridges.

For more information on print cartridges, see [Print cartridge troubleshooting](#).

A borderless copy has white space around the edges

Cause: You are trying to make a borderless copy of a very small original.

Solution: When you make a borderless copy of a very small original, the HP All-in-One enlarges the original up to a maximum percentage. This might leave white space around the edges. (The maximum percentage varies by model.)

Depending on the size of the borderless copy you are trying to make, the minimum size of the original varies. For example, you cannot enlarge a passport photo to create a letter-size borderless copy.

If you want to make a borderless copy of a very small original, scan the original into the computer, resize the image, and then print a borderless copy of the enlarged image.

Cause: You are trying to make a borderless copy without using photo paper.

Solution: Use photo paper to make borderless copies.

Scan troubleshooting

Use this section to solve these scan problems:

- [Scan halts](#)
- [Scan fails](#)
- [Scan fails because of insufficient computer memory](#)
- [Scanned image is blank](#)
- [Scanned image is incorrectly cropped](#)
- [Scanned image has incorrect page layout](#)
- [Text format is incorrect](#)
- [Scanned image shows dotted lines instead of text](#)
- [Text is incorrect or missing](#)

Scan halts

Cause: The computer system resources might be low.

Solution: Turn off the HP All-in-One and then turn it back on. Turn off the computer and then turn it back on.

If this does not work, try changing the scan to a lower resolution in the software.

Scan fails

Cause: The computer is not turned on.

Solution: Turn on your computer.

Cause: Your computer is not connected to the HP All-in-One by a USB cable.

Solution: Connect your computer to the HP All-in-One with a standard USB cable. For more information, see the Setup Guide.

Cause: The HP Photosmart Software might not have been installed.

Solution: Insert the HP All-in-One installation CD and install the software. For more information, see the Setup Guide.

Cause: The HP Photosmart Software is installed, but is not running.

Solution: Open the software you installed with the HP All-in-One and try scanning again.

 **NOTE:** To check to see whether the software is running, right-click on the **HP Digital Imaging Monitor** icon in the system tray at the far right of the Windows taskbar. Pick a device in the list, and then click **Display Status**.

Scan fails because of insufficient computer memory

Cause: Too many applications are running on your computer.

Solution: Close all applications that are not in use. This includes applications that run in the background, such as screen savers and virus checkers. If you turn off your virus checker, remember to turn it back on after you finish your scan.

If this problem occurs frequently, or if you encounter memory problems while using other applications, you might need to add more memory to your computer. See the user guide that came with your computer for more information.

Scanned image is blank

Cause: The original is placed incorrectly on the glass.

Solution: Place your original with the side you want to copy or scan face down on the left front corner of the glass.

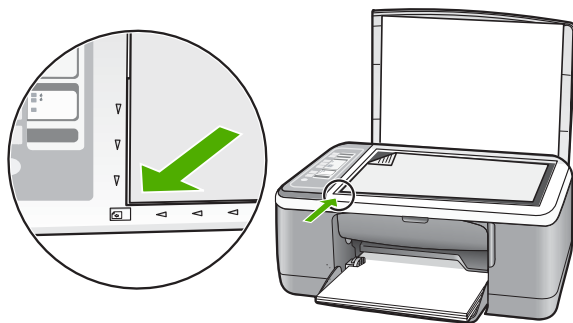

Scanned image is incorrectly cropped

Cause: The software is set to automatically crop scanned pictures.

Solution: The autocropping feature in the software crops anything that is not part of the main image. Sometimes this might not be what you want. In that case, turn off autocropping in the software and crop the scanned image manually, or not at all.

Scanned image has incorrect page layout

Cause: The automatic cropping feature in the software is changing the page layout.

Solution: Turn off autocropping in the software to retain the page layout.

Text format is incorrect

Cause: The scan document settings are incorrect.

Solution: Some applications cannot handle framed text formatting. Framed text is one of the scan document settings in the software. It maintains complex layouts, such as multiple columns from a newsletter, by putting the text in different frames (boxes) in the destination application. In the software, select the correct format so that the scanned text layout and formatting are retained.

Scanned image shows dotted lines instead of text

Cause: If you use the **Text** image type to scan text that you plan to edit, the scanner might not recognize color text. The **Text** image type scans at 300 x 300 dpi, in black and white.

If you are scanning an original that has graphics or artwork surrounding the text, the scanner might not recognize the text.

Solution: Make a black-and-white copy of the original and then scan the copy.

Text is incorrect or missing

Cause: The brightness is not set correctly.

Solution: Adjust the brightness in the software, and then rescan the original.

To adjust the brightness

1. In the **HP Scanning** window, click **Lighten/Darken** in the **Basic** menu or the **Tools** panel.
 2. Adjust the brightness indicators.
-

Cause: Debris might be stuck on the glass or on the back of the document lid. This can cause poor-quality scans.

Solution: Turn off the HP All-in-One, unplug the power cord, and use a soft cloth to wipe the glass and the back of the document lid.

For more information, see:

- [Clean the lid backing](#)
 - [Clean the glass](#)
-

Cause: The scan document settings are not set to the correct optical character recognition (OCR) language. The **OCR language** tells the software how to interpret the characters it sees in the original image. If the **OCR language** does not match the language in the original, the scanned text might be incomprehensible.

Solution: Select the correct OCR language in the software.



NOTE: If you are using the HP Photosmart Software, the Optical Character Recognition (OCR) software might not be installed on your computer. To install the OCR software, you must re-insert the software disk and select **OCR** under the **Custom** installation options.

See the documentation that came with Readiris, or whichever OCR software you use, for information on how to select the **OCR language**.

Errors

If the HP All-in-One has an error, the lights on the device might flash, or an error message might appear on your computer screen.

This section contains the following topics:

- [Flashing lights](#)
- [Device messages](#)
- [File messages](#)
- [General user messages](#)
- [Paper messages](#)
- [Power and connection messages](#)
- [Print cartridge messages](#)

Flashing lights

The lights on the HP All-in-One flash in special sequences to inform you about various error conditions. Refer to the following table for information on solving your error condition based on which lights are on or blinking on the HP All-in-One.

On light	Resume light	Check Print Cartridge light	Paper Type lights	Description	Solution
Off	Off	Off	Both off	The HP All-in-One is turned off.	Press the On button to turn the HP All-in-One on.
Blinking	Off	Off	1 On, 1 Off	The HP All-in-One is processing a job, such as print, scan, copy, or alignment.	Wait for the HP All-in-One to finish.
Blink faster for 3 seconds and then On	Off	Off	1 On, 1 Off	The HP All-in-One is busy.	Wait for the HP All-in-One to finish.
Blink for 20 seconds and then On	Off	Off	1 On, 1 Off	Scan was pressed, and there was no response from the computer.	Make sure the computer is turned on, the HP All-in-One software is installed, and the computer is

(continued)

On light	Resume light	Check Print Cartridge light	Paper Type lights	Description	Solution
					connected to the HP All-in-One with a USB cable.
On	Blinking	Off	1 On, 1 Off	The HP All-in-One is out of paper.	Load paper and press Start Copy Black or Start Copy Color .
				The HP All-in-One has a paper jam.	Clear the paper jam, and press Start Copy Black or Start Copy Color .
				Paper-size setting does not match the paper size detected in the input tray.	Change the paper in the tray or the size setting in the software.
On	Off	Blinking	1 On, 1 Off	Print cartridge door is open.	Raise the door to close it.
				The print cartridges are missing or not seated correctly.	Install or remove and reinsert print cartridges.
				The tape was not removed from the print cartridge.	Remove print cartridge, remove tape, and reinsert print cartridge.
				The print cartridge is not intended for use in this HP All-in-One.	The print cartridge might not be supported for use in the HP All-in-One. See the Order Supplies chapter in the User Guide.

(continued)

On light	Resume light	Check Print Cartridge light	Paper Type lights	Description	Solution
				The print cartridge might be defective.	<ol style="list-style-type: none"> 1. Remove the black print cartridge. 2. Close the print cartridge door. 3. Check the On light. <ul style="list-style-type: none"> • If the On light blinks, replace the tri-color print cartridge. • If the On light remains steadily lit, replace the black print cartridge.
On	Blinking	Blinking	1 On, 1 Off	The print carriage is stalled.	Open the print cartridge door, and check that the carriage is not blocked.
On	Blinking	Blinking	Both blinking	The control panel overlay is not attached or is not attached properly.	<ol style="list-style-type: none"> 1. Turn the HP All-in-One off. 2. Attach the control panel overlay using the instructions in the Setup Guide. 3. Turn the HP All-in-One back on.
Blinking	Blinking	Blinking	Both off	Scanner failure	<p>Turn the HP All-in-One off, then on again.</p> <p>If the problem persists, contact HP customer support.</p>
Blinking	Blinking	Blinking	Both blinking	The HP All-in-One has a fatal error.	<ol style="list-style-type: none"> 1. Turn the HP All-in-One off. 2. Unplug the power cord. 3. Wait a minute, then plug the power cord back in. 4. Turn the HP All-in-One back on.

(continued)

On light	Resume light	Check Print Cartridge light	Paper Type lights	Description	Solution
					If the problem persists, contact HP Support.

Device messages

The following is a list of device-related error messages:

- [Firmware revision mismatch](#)
- [Mechanism error](#)
- [Memory is full](#)
- [Scanner failure](#)

Firmware revision mismatch

Cause: The revision number of the HP All-in-One firmware does not match the revision number of the software.

Solution: To find support and warranty information, go to the HP Web site at www.hp.com/support. If prompted, choose your country/region, and then click **Contact HP** for information on calling for technical support.

Mechanism error

Cause: The HP All-in-One has a paper jam.

Solution: Clear the paper jam.

For more information, see:

[Clear paper jams](#)

Cause: The print carriage is blocked.

Solution: Turn the HP All-in-One off, remove any objects that are blocking the print carriage (including any packing materials), and then turn the HP All-in-One on again.

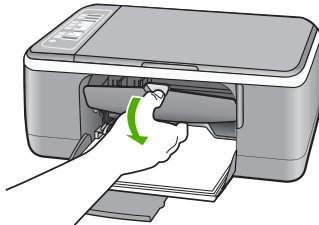

Memory is full

Cause: The document you are copying has exceeded the memory of the HP All-in-One.

Solution: Try making fewer copies at a time.

Scanner failure

Cause: The HP All-in-One is busy or an unknown cause has interrupted your scan.

Solution: Turn off the HP All-in-One and then turn it on again. Restart your computer and then try to scan again.

If the problem persists, try plugging the power cord directly into a grounded power outlet rather than a surge protector or power strip. If the problem continues, contact HP Support. Go to www.hp.com/support. If prompted, choose your country/region, and then click **Contact HP** for information on calling for technical support.

File messages

The following is a list of file-related error messages:

- [Error reading or writing the file](#)
- [File not found](#)
- [File format not supported](#)
- [Invalid file name](#)
- [Supported file types for the HP All-in-One](#)

Error reading or writing the file

Cause: The HP All-in-One software could not open or save the file.

Solution: Check to see if you have the right folder and file name.

File not found

Cause: There is not enough available memory on your computer to create a print preview file.

Solution: Close some applications and try the task again.

File format not supported

Cause: The HP All-in-One software did not recognize or support the file format of the image you are trying to open or save. If the file extension indicates it is a supported file type, the file might be corrupted.

Solution: Open the file in another application, and save it in a format that the HP All-in-One software recognizes.

For more information, see:

[Supported file types for the HP All-in-One](#)

Invalid file name

Cause: The file name you entered is invalid.

Solution: Make sure that you are not using any invalid symbols in the file name.

Supported file types for the HP All-in-One

When you save a scanned image, the HP All-in-One software recognizes the following file formats: BMP, DCX, FPX, GIF, JPG, PCD, PCX, and TIF.

General user messages

The following is a list of messages related to common user errors:

- [Cannot crop](#)
- [Disconnected](#)
- [No scan options](#)
- [Out of disk space](#)

Cannot crop

Cause: The computer does not have enough memory.

Solution: Close all applications that are not in use. This includes applications that run in the background, such as screen savers and virus checkers. If you turn off your virus checker, remember to turn it back on after you finish your scan.

If this problem occurs frequently, or if you encounter memory problems while using other applications, you might need to add more memory to your computer. See the user guide that came with your computer for more information.

Cause: For scanning, there must be at least 50 MB of space available on your computer's hard disk.

Solution: Empty the Recycle Bin on your desktop. You might also need to remove files from the hard disk; for example, delete temporary files.

Disconnected

Cause: Several situations can cause this error message to appear.

- Your computer is not turned on.
- Your computer is not connected to the HP All-in-One.

- The software that came with the HP All-in-One was not installed correctly.
- The software that came with the HP All-in-One is installed, but it is not running.

Solution: Make sure your computer is turned on and is connected to the HP All-in-One. Also make sure you installed the software that came with the HP All-in-One.

For more information, see:

[Communication problems over a USB connection](#)

No scan options

Cause: The software that came with the HP All-in-One is not running, or has never been installed.

Solution: Make sure the software is installed and running. For more information, see the Setup Guide that came with the HP All-in-One.

Out of disk space

Cause: There is not enough available memory on your computer to perform the task.

Solution: Close some applications and try the task again.

Paper messages

The following is a list of paper-related error messages:

- [Cannot load paper from input tray](#)
- [Ink is drying](#)
- [Out of paper](#)
- [Paper jam, misfeed or blocked carriage](#)
- [Paper mismatch](#)
- [Wrong paper width](#)

Cannot load paper from input tray

Cause: There is not enough paper in the input tray.

Solution: If the HP All-in-One is out of paper or there are only a few sheets remaining, load more paper in the input tray. If there is paper in the input tray, remove the paper, tap the stack of paper against a flat surface, and reload the paper into the input tray. To continue your print job, press the **Resume** button on the control panel of the HP All-in-One.

Ink is drying

Cause: Transparencies and some other media require a drying time that is longer than normal.

Solution: Leave the sheet in the output tray until the message disappears. If it is necessary to remove the printed sheet before the message disappears, carefully hold the printed sheet on the underside or the edges, and place it on a flat surface to dry.

Out of paper

Cause: There is not enough paper in the input tray.

Solution: If the HP All-in-One is out of paper or there are only a few sheets remaining, load more paper in the input tray. If there is paper in the input tray, remove the paper, tap the stack of paper against a flat surface, and reload the paper into the input tray. To continue your print job, press the **Resume** button on the control panel of the HP All-in-One.

Cause: The rear door is off the HP All-in-One.

Solution: If you removed the rear door to clear a paper jam, replace it.

For more information, see:

[Clear paper jams](#)

Paper jam, misfeed or blocked carriage

Cause: The HP All-in-One has a paper jam.

Solution: Clear the paper jam.

For more information, see:

[Clear paper jams](#)

Cause: The print carriage is blocked.

Solution: Turn the HP All-in-One off, remove any objects that are blocking the print carriage (including any packing materials), and then turn the HP All-in-One on again.

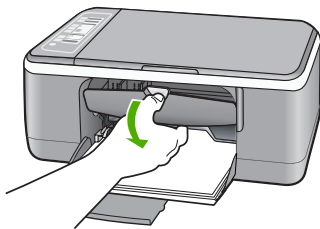

Paper mismatch

Cause: The print setting for the print job does not match the paper type or size loaded in the HP All-in-One.

Solution: Change the print setting or load the appropriate paper in the input tray.

For more information, see:

- [Set the paper type for printing](#)
- [Choose papers for printing and copying](#)

Wrong paper width

Cause: The print setting for the print job does not match the paper type or size loaded in the HP All-in-One.

Solution: Change the print setting or load the appropriate paper in the input tray.

For more information, see:

- [Set the paper type for printing](#)
- [Choose papers for printing and copying](#)

Power and connection messages

The following is a list of power- and connection-related error messages:

- [HP All-in-One not found](#)
- [Communication test failed](#)
- [Improper shutdown](#)
- [Two-way communication lost](#)

HP All-in-One not found

Cause: This error applies only to USB-connected devices. The USB cable is not plugged in properly.

Solution: If the HP All-in-One is not properly connected to the computer, communication errors can occur. Make sure the USB cable is securely connected to the HP All-in-One and the computer, as shown below.

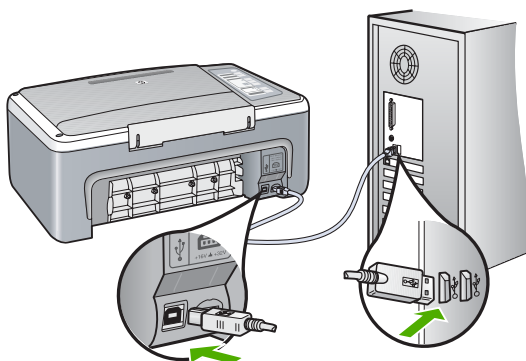

For more information, see:

[Communication problems over a USB connection](#)

Communication test failed

Cause: The HP All-in-One is turned off.

Solution: Look at the **On** light located on the front of the HP All-in-One. If it is not lit, the HP All-in-One is turned off. Make sure the power cord is firmly connected to the HP All-in-One and plugged into a power outlet. Press the **On** button to turn on the HP All-in-One.

Cause: The computer is not communicating with the HP All-in-One.

Solution: If the HP All-in-One is not properly connected to the computer, communication errors can occur. Make sure the USB cable is connected to the HP All-in-One and the computer as shown below.

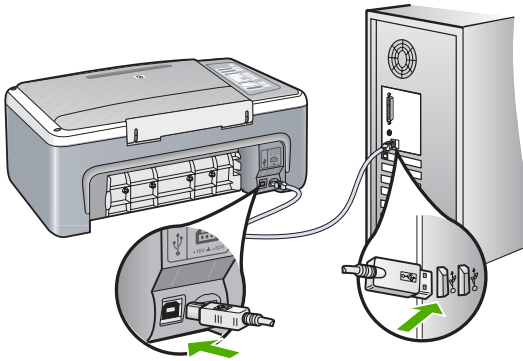

For more information, see:

[Communication problems over a USB connection](#)

Improper shutdown

Cause: The last time the HP All-in-One was used, it was not turned off properly. If the HP All-in-One is turned off by turning off the switch on a power strip or by using a wall switch, the device can be damaged.

Solution: Press the **On** button located on the control panel of the HP All-in-One to turn the device on and off.

Two-way communication lost

Cause: The HP All-in-One is turned off.

Solution: Look at the **On** light located on the front of the HP All-in-One. If it is not lit, the HP All-in-One is turned off. Make sure the power cord is firmly connected to

the HP All-in-One and plugged into a power outlet. Press the **On** button to turn on the HP All-in-One.

Cause: The HP All-in-One is not connected to the computer.

Solution: If the HP All-in-One is not properly connected to the computer, communication errors can occur. Make sure the USB cable is securely connected to the HP All-in-One and the computer, as shown below.

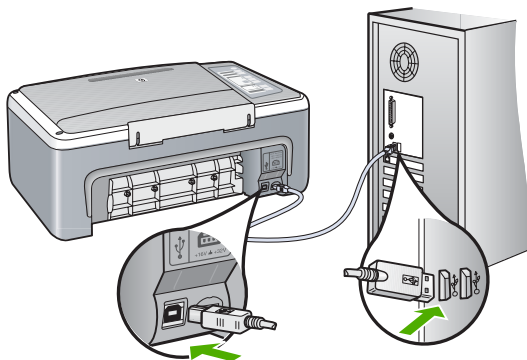

For more information, see:

[Communication problems over a USB connection](#)

Print cartridge messages

The following is a list of print cartridge error messages:

- [Low on ink](#)
- [Need alignment or alignment failed](#)
- [Print cartridge is missing, incorrectly installed, or not intended for your device](#)
- [Printing in ink-backup mode](#)
- [Print cartridge is faulty or not installed properly](#)

Low on ink

Cause: One or both print cartridges might be out of ink.

Solution: Check the estimated ink levels remaining in the print cartridges. If the print cartridges are low or out of ink, you might need to replace the print cartridges.

 **NOTE:** The HP All-in-One can only detect the ink levels for genuine HP ink. The ink levels in print cartridges that are refilled or have been used in other devices, might not register accurately.

If there is ink remaining in the print cartridges, but you are still noticing a problem, print a self-test report to determine if there is a problem with the print cartridges. If the self-test report shows a problem, clean the print cartridges. If the problem persists, you might need to replace the print cartridges.

 **NOTE:** Do not remove the old print cartridge until a new one is available.

For more information on print cartridges, see [Print cartridge troubleshooting](#).

Need alignment or alignment failed

Cause: The incorrect type of paper is loaded in the input tray.

Solution: If you have colored paper loaded in the input tray when you align the print cartridges, the alignment fails. Load unused plain white letter or A4 paper into the input tray, and then try the alignment again. If the alignment fails again, you might have a defective sensor or print cartridge.

To find support and warranty information, go to the HP Web site at www.hp.com/support. If prompted, choose your country/region, and then click **Contact HP** for information on calling for technical support.

Cause: Protective tape is covering the print cartridges.

Solution: Check each print cartridge. The tape might have been removed from the copper-colored contacts, but still might cover the ink nozzles. If the tape is still covering the ink nozzles, carefully remove the tape from the print cartridges. Do not touch the ink nozzles or the copper-colored contacts.

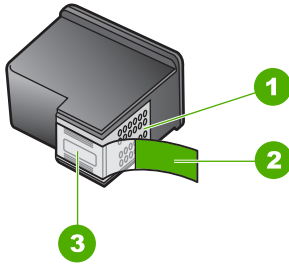

1	Copper-colored contacts
2	Plastic tape with pink pull tab (must be removed before installing)
3	Ink nozzles under tape



Remove and then reinsert the print cartridges. Verify that they are fully inserted and locked in place.

Cause: The contacts on the print cartridge are not touching the contacts in the print carriage.

Solution: Remove and then reinsert the print cartridges. Verify that they are fully inserted and locked in place.

Cause: The print cartridge or sensor is defective.

Solution: To find support and warranty information, go to the HP Web site at www.hp.com/support. If prompted, choose your country/region, and then click **Contact HP** for information on calling for technical support.

Cause: You installed new print cartridges that might need alignment.

Solution: You must align the print cartridges to ensure excellent print quality.

If the alignment error persists and you cannot clear it, your print cartridge might be defective. Contact HP for support.

To find support and warranty information, go to the HP Web site at www.hp.com/support. If prompted, choose your country/region, and then click **Contact HP** for information on calling for technical support.

For more information, see:

[Align the print cartridges](#)

Print cartridge is missing, incorrectly installed, or not intended for your device

Cause: The print cartridge is missing.

Solution: One or both of the print cartridges is missing. Remove and reinsert the print cartridges and verify that they are fully inserted and locked in place. If the problem persists, clean the contacts of the print cartridges.

For more information on print cartridges, see [Print cartridge troubleshooting](#).

Cause: Protective tape is covering the print cartridges.

Solution: Check each print cartridge. The tape might have been removed from the copper-colored contacts, but still might cover the ink nozzles. If the tape is still

covering the ink nozzles, carefully remove the tape from the print cartridges. Do not touch the ink nozzles or the copper-colored contacts.

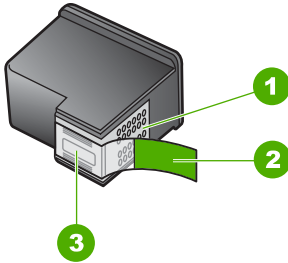

1	Copper-colored contacts
2	Plastic tape with pink pull tab (must be removed before installing)
3	Ink nozzles under tape



Cause: One or both of the print cartridges are not installed or are installed incorrectly.

Solution: Remove and then reinsert the print cartridges. Verify that they are fully inserted and locked in place.

If the problem persists, clean the copper-colored contacts of the print cartridges.

For more information on print cartridges, see [Print cartridge troubleshooting](#).

Cause: The print cartridge is defective or not intended for use in this device.

Solution: To find support and warranty information, go to the HP Web site at www.hp.com/support. If prompted, choose your country/region, and then click **Contact HP** for information on calling for technical support.

Printing in ink-backup mode

Cause: When the HP All-in-One detects that only one print cartridge is installed, ink-backup mode is initiated. This printing mode lets you print with a single print cartridge, but it slows the device and affects the quality of printouts.

Solution: If you receive the ink-backup mode message and two print cartridges are installed in the HP All-in-One, verify that the protective piece of plastic tape has been

removed from each print cartridge. When plastic tape covers the print cartridge contacts, the device cannot detect that the print cartridge is installed.

Print cartridge is faulty or not installed properly

Cause: The printer cannot print if the print cartridges are faulty, or if they are not installed properly.

Solution:

To resolve the problem

1. Open the print cartridge door.
2. Do one of the following:
 - If an error message is displayed on screen, remove the print cartridge that is named in the error message. Go to step 3.
 - If an error message is not displayed, remove and reinstall each print cartridge and close the print cartridge door.
If the Check Print Cartridge light is not flashing, the problem is solved.
If the Check Print Cartridge light is flashing, go to step 4.
3. Reinstall the print cartridge and close the print cartridge door. For more information, see [Replace the print cartridges](#).
If the Check Print Cartridge light is not flashing, the problem is solved.
If the Check Print Cartridge light is flashing, go to step 4.
4. Manually clean the print cartridge. For more information, see [Clean the print cartridge contacts](#).
5. Reinsert the print cartridge in the device and close the print cartridge door.
If the Check Print Cartridge light is still flashing, the print cartridge is faulty and must be replaced.

 **NOTE:** You can print with one print cartridge in ink-backup mode if you do not have a replacement print cartridge available. For more information, see [Use ink-backup mode](#).

6. If the Check Print Cartridge light continues to flash after replacing the print cartridge, visit HP Technical Support at www.hp.com/support.
-

13 HP warranty and support

Hewlett-Packard provides Internet and phone support for the HP All-in-One.

This section contains the following topics:

- [Warranty](#)
- [Support process](#)
- [Before you call HP customer support](#)
- [HP support by phone](#)
- [Additional warranty options](#)
- [Call HP Korea customer support](#)
- [Prepare the HP All-in-One for shipment](#)
- [Pack the HP All-in-One](#)

Warranty

For more information about the warranty, see the printed documentation that came with the HP All-in-One.

Support process

If you have a problem, follow these steps:

1. Check the documentation that came with the HP All-in-One.
2. Visit the HP online support Web site at www.hp.com/support. HP online support is available to all HP customers. It is the fastest source for up-to-date device information and expert assistance and includes the following features:
 - Fast access to qualified online support specialists
 - Software and driver updates for the HP All-in-One
 - Valuable HP All-in-One and troubleshooting information for common problems
 - Proactive device updates, support alerts, and HP newsgrams that are available when you register the HP All-in-One
3. Call HP support. Support options and availability vary by device, country/region, and language.

Before you call HP customer support

Software programs from other companies might be included with the HP All-in-One. If you experience problems with any of those programs, you will receive the best technical assistance by calling the experts at that company.

If you need to contact HP support, do the following before you call:

1. Make sure that:
 - a. The HP All-in-One is plugged in and turned on.
 - b. The specified print cartridges are installed correctly.
 - c. The recommended paper is properly loaded in the input tray.
2. Reset the HP All-in-One:
 - a. Turn off the HP All-in-One by pressing the **On** button.
 - b. Unplug the power cord from the back of the HP All-in-One.
 - c. Plug the power cord back into the HP All-in-One.
 - d. Turn on the HP All-in-One by pressing the **On** button.

3. To find support and warranty information, go to the HP Web site at www.hp.com/support. If prompted, choose your country/region, and then click **Contact HP** for information on calling for technical support.

Check the HP Web site for updated information or troubleshooting tips for the HP All-in-One.

4. If you are still experiencing problems and need to speak with an HP support Representative, do the following:
 - a. Have the specific name of the HP All-in-One, as it appears on the control panel, available.
 - b. Print a self-test report.
 - c. Make a color copy to have available as a sample printout.
 - d. Be prepared to describe your problem in detail.
 - e. Have your serial number ready.
You can view the serial number by looking at the sticker on the rear side of the HP All-in-One. The serial number is the 10-character code in the upper left corner of the sticker.
5. Call HP support. Be near the HP All-in-One when you call.

Related topics

- [Print a self-test report](#)
- [Placing a call](#)

HP support by phone

For a list of support phone numbers, see the printed documentation that came with the device.

This section contains the following topics:

- [Phone support period](#)
- [Placing a call](#)
- [After the phone support period](#)

Phone support period

One year of phone support is available in North America, Asia Pacific, and Latin America (including Mexico). To determine the duration of phone support in Europe, the Middle East, and Africa, go to www.hp.com/support. Standard phone company charges apply.

Placing a call

Call HP support while you are in front of the computer and the HP All-in-One. Be prepared to provide the following information:

- Model number (located on the label on the front of the HP All-in-One)
- Serial number (located on the back or bottom of the HP All-in-One)
- Messages that appear when the situation occurs
- Answers to these questions:
 - Has this situation happened before?
 - Can you re-create it?
 - Did you add any new hardware or software to your computer at about the time that this situation began?
 - Did anything else occur prior to this situation (such as a thunderstorm, HP All-in-One was moved, etc.)?

After the phone support period

After the phone support period, help is available from HP at an additional cost. Help may also be available at the HP online support Web site: www.hp.com/support. Contact your HP dealer or call the support phone number for your country/region to learn more about support options.

Additional warranty options

Extended service plans are available for the HP All-in-One at additional costs. Go to www.hp.com/support, select your country/region and language, then explore the services and warranty area for information about the extended service plans.

Call HP Korea customer support

HP 한국 고객 지원 문의

- *고객 지원 센터 대표 전화
1588-3003
- *제품가격 및 구입처 정보 문의 전화
080-703-0700
- *전화 상담 가능 시간 :
평 일 09:00~18:00
토요일 09:00~13:00
(일요일,공휴일 제외)

Prepare the HP All-in-One for shipment

If after contacting HP Customer Support or returning to the point of purchase you are requested to send the HP All-in-One in for service, make sure you remove and keep the following items before returning your device:

- The print cartridges
- The power cord, USB cable, and any other cable connected to the HP All-in-One
- Any paper loaded in the input tray
- Any originals loaded in the HP All-in-One

To remove print cartridges before shipment

1. Turn on the HP All-in-One and wait until the print carriage is idle and silent. If the HP All-in-One will not turn on, skip this step and go to step 2.
2. Open the print cartridge door.
3. Remove the print cartridges from their slots.

 **NOTE:** If the HP All-in-One does not turn on, you can unplug the power cord and then manually slide the print carriage to the center to remove the print cartridges.

4. Place the print cartridges in an airtight plastic container so they will not dry out, and put them aside. Do not send them with the HP All-in-One unless the HP customer support call agent instructs you to.
5. Close the print cartridge door and wait a few minutes for the print carriage to move back to its home position (on the left side).

 **NOTE:** Make sure the scanner is idle and has returned to its parked position before turning off the HP All-in-One.

6. Press the **On** button to turn off the HP All-in-One.

Pack the HP All-in-One

Complete the following steps once you have removed the print cartridges, turned off the HP All-in-One, and unplugged it.

To pack the HP All-in-One

1. If available, pack the HP All-in-One for shipment by using the original packing materials or the packaging materials that came with your exchange device.

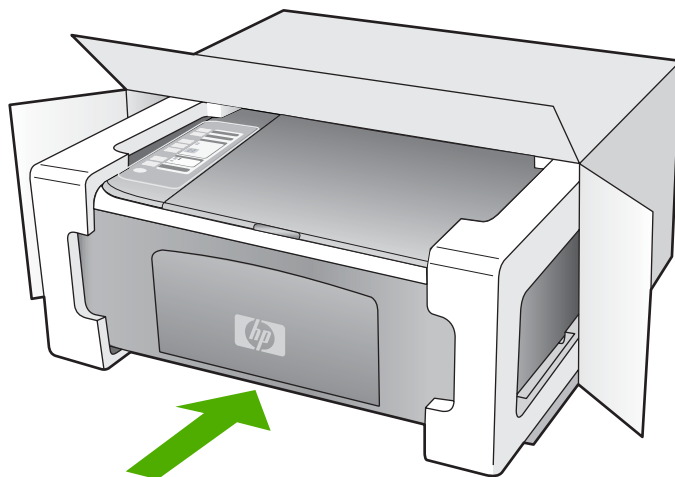

If you do not have the original packaging materials, please use other adequate packaging materials. Shipping damage caused by improper packaging and/or improper transportation is not covered under the warranty.

2. Place the return shipping label on the outside of the box.
3. Include the following items in the box:
 - A complete description of symptoms for service personnel (samples of print quality problems are helpful).
 - A copy of the sales slip or other proof of purchase to establish the warranty coverage period.
 - Your name, address, and a phone number where you can be reached during the day.

14 Technical information

The technical specifications and international regulatory information for the HP All-in-One are provided in this section.

For additional specifications, see the printed Basics Guide.

This section contains the following topics:

- [Specifications](#)
- [Environmental product stewardship program](#)
- [Regulatory notices](#)

Specifications

Technical specifications for the HP All-in-One are provided in this section. For additional specifications, see the printed Basics Guide.

System requirements

Software and system requirements are located in the Readme file.

For information about future operating system releases and support, visit the HP online support Web site at www.hp.com/support.

Paper specifications

Type	Paper weight	Paper tray*	Output tray*
Plain paper	20 to 24 lb. (75 to 90 gsm)	100 (20 lb. paper)	50 (20 lb. paper)
Legal paper	20 to 24 lb. (75 to 90 gsm)	100 (20 lb. paper)	50 (20 lb. paper)
Cards	110 lb. index max (200 gsm)	20	10
Envelopes	20 to 24 lb. (75 to 90 gsm)	10	10
Transparency film	N/A	20	15 or fewer
Labels	N/A	20	10
4 x 6 inch (10 x 15 cm) Photo paper	145 lb. (236 gsm)	20	15
8.5 x 11 inch (216 x 279 mm) Photo paper	N/A	20	10

* Maximum capacity.

* Output tray capacity is affected by the type of paper and the amount of ink you are using. HP recommends emptying the output tray frequently.



NOTE: For a complete list of supported media sizes, see the printer software.

Copy specifications

- Digital image processing
- Up to 9 copies from original (depends on model)

- Copy speeds vary according to the complexity of the document and model
- Maximum copy enlargement ranging from 200-400% (depends on model)
- Maximum copy reduction ranging from 25-50% (depends on model)

Scan specifications

- Image editor included
- Integrated OCR software automatically converts scanned text to editable text (if installed)
- Twain-compliant software interface
- Resolution: up to 1200 x 2400 ppi optical (depends on model); 19200 ppi enhanced (software)
For more information about ppi resolution, see the scanner software.
- Color: 48-bit color, 8-bit grayscale (256 levels of gray)
- Maximum scan size from glass: 21.6 x 29.7 cm (8.5 x 11.7 inches)

Print resolution

To find out about the printer resolution, see the printer software. For more information, see [View the print resolution](#).

Print cartridge yield

Visit www.hp.com/pageyield for more information on estimated cartridge yields.

Acoustic information

If you have Internet access, you can get acoustic information from the HP Web site. Go to: www.hp.com/support.

Environmental product stewardship program

Hewlett-Packard is committed to providing quality products in an environmentally sound manner. Design for recycling has been incorporated into this product. The number of materials has been kept to a minimum while ensuring proper functionality and reliability. Dissimilar materials have been designed to separate easily. Fasteners and other connections are easy to locate, access, and remove using common tools. High priority parts have been designed to access quickly for efficient disassembly and repair.

For more information, visit HP's Commitment to the Environment Web site at:

www.hp.com/hpinfo/globalcitizenship/environment/index.html

This section contains the following topics:

- [Paper use](#)
- [Plastics](#)
- [Material safety data sheets](#)
- [Recycling program](#)
- [HP inkjet supplies recycling program](#)
- [Energy consumption](#)
- [Disposal of Waste Equipment by Users in Private Households in the European Union](#)

Paper use

This product is suited for the use of recycled paper according to DIN 19309 and EN 12281:2002.

Plastics

Plastic parts over 25 grams are marked according to international standards that enhance the ability to identify plastics for recycling purposes at the end of product life.

Material safety data sheets

Material safety data sheets (MSDS) can be obtained from the HP Web site at:

www.hp.com/go/msds

Recycling program

HP offers an increasing number of product return and recycling programs in many countries/regions, and partners with some of the largest electronic recycling centers throughout the world. HP conserves resources by reselling some of its most popular products. For more information regarding recycling of HP products, please visit:

www.hp.com/hpinfo/globalcitizenship/environment/recycle/

HP inkjet supplies recycling program

HP is committed to protecting the environment. The HP Inkjet Supplies Recycling Program is available in many countries/regions, and lets you recycle used print cartridges and ink cartridges free of charge. For more information, go to the following Web site:

www.hp.com/hpinfo/globalcitizenship/environment/recycle/

Energy consumption

This product is designed to reduce power consumption and save natural resources without compromising product performance. It has been designed to reduce total energy consumption both during operation and when the device is not active. Specific information on power consumption may be found in the product specifications.

Disposal of Waste Equipment by Users in Private Households in the European Union



English	<p>Disposal of Waste Equipment by Users in Private Households in the European Union</p> <p>This symbol on the product or on its packaging indicates that this product must not be disposed of with your other household waste. Instead, it is your responsibility to dispose of your waste equipment by handing it over to a designated collection point for the recycling of waste electrical and electronic equipment. The separate collection and recycling of your waste equipment at the time of disposal will help to conserve natural resources and ensure that it is recycled in a manner that protects human health and the environment. For more information about where you can drop off your waste equipment for recycling, please contact your local city office, your household waste disposal service or the shop where you purchased the product.</p>
Français	<p>Évacuation des équipements usagés par les utilisateurs dans les foyers privés au sein de l'Union européenne</p> <p>La présence de ce symbole sur le produit ou sur son emballage indique que vous ne pouvez pas vous débarrasser de ce produit de la même façon que vos déchets courants. Au contraire, vous êtes responsable de l'évacuation de vos équipements usagés et, à cet effet, vous êtes tenu de les remettre à un point de collecte agréé pour le recyclage des équipements électriques et électroniques usagés. Le tri, l'évacuation et le recyclage séparés de vos équipements usagés permettent de préserver les ressources naturelles et de s'assurer que ces équipements sont recyclés dans le respect de la santé humaine et de l'environnement. Pour plus d'informations sur les lieux de collecte des équipements usagés, veuillez contacter votre mairie, votre service de traitement des déchets ménagers ou le magasin où vous avez acheté le produit.</p>
Deutsch	<p>Entsorgung von Elektrogeräten durch Benutzer in privaten Haushalten in der EU</p> <p>Dieses Symbol auf dem Produkt oder dessen Verpackung gibt an, dass das Produkt nicht zusammen mit dem Restmüll entsorgt werden darf. Es obliegt daher Ihrer Verantwortung, das Gerät an einer entsprechenden Stelle für die Entsorgung oder Wiederverwertung von Elektrogeräten aller Art abzugeben (z.B. ein Wertstoffhof). Die separate Sammlung und das Recyceln Ihrer alten Elektrogeräte zum Zeitpunkt ihrer Entsorgung trägt zum Schutz der Umwelt bei und gewährleistet, dass sie auf eine Art und Weise recycelt werden, die keine Gefährdung für die Gesundheit des Menschen und der Umwelt darstellt. Weitere Informationen darüber, wo Sie alte Elektrogeräte zum Recyceln abgeben können, erhalten Sie bei den örtlichen Behörden, Wertstoffhöfen oder dort, wo Sie das Gerät erworben haben.</p>
Italiano	<p>Smaltimento di apparecchiature da rottamare da parte di privati nell'Unione Europea</p> <p>Questo simbolo che appare sul prodotto o sulla confezione indica che il prodotto non deve essere smaltito assieme agli altri rifiuti domestici. Gli utenti devono provvedere allo smaltimento delle apparecchiature da rottamare portandole al luogo di raccolta indicato per il riciclaggio delle apparecchiature elettriche ed elettroniche. La raccolta e il riciclaggio separati delle apparecchiature da rottamare in fase di smaltimento favoriscono la conservazione delle risorse naturali e garantiscono che tali apparecchiature vengano rotamate nel rispetto dell'ambiente e della tutela della salute. Per ulteriori informazioni sui punti di raccolta delle apparecchiature da rottamare, contattare il proprio comune di residenza, il servizio di smaltimento dei rifiuti locale o il negozio presso il quale è stato acquistato il prodotto.</p>
Español	<p>Eliminación de residuos de aparatos eléctricos y electrónicos por parte de usuarios domésticos en la Unión Europea</p> <p>Este símbolo en el producto o en el embalaje indica que no se puede deshechar el producto junto con los residuos domésticos. Por el contrario, si debe eliminar este tipo de residuo, es responsabilidad del usuario entregarlo en un punto de recogida designado de reciclado de aparatos electrónicos y eléctricos. El reciclaje y la recogida por separado de estos residuos en el momento de la eliminación ayudará a preservar recursos naturales y a garantizar que el reciclaje protege la salud y el medio ambiente. Si desea información adicional sobre los lugares donde dejar estos residuos para su reciclado, póngase en contacto con las autoridades locales de su ciudad, con el servicio de gestión de residuos domésticos o con la tienda donde adquirió el producto.</p>
Česky	<p>Likvidace vyloučeného zařízení užívateli v domácnosti v zemích EU</p> <p>Tato značka na produktu nebo na jeho obalu označuje, že tento produkt nesmí být likvidován prostým vyhozením do běžného domovního odpadu. Odpovědné za to, že vyloučená zařízení bude předána k likvidaci do stávajících sběrných míst určených k recyklaci vyloučených elektrických a elektronických zařízení. Likvidace vyloučeného zařízení samostatným sběrem a recyklací napomáhá zachování přírodních zdrojů a zajišťuje, že recyklace proběhne způsobem chránícím chráním lidské zdraví a životní prostředí. Další informace o tom, kam můžete vyloučená zařízení předat k recyklaci, můžete získat od úřadů místní samosprávy, od společnosti provádějící svoz a likvidaci domovního odpadu nebo v obchodě, kde jste produkt zakoupili.</p>
Dansk	<p>Bortskaffelse af affaldsudstyr for brugere i private husholdninger i EU</p> <p>Dette symbol på produktet eller på dets emballage indikerer, at produktet ikke må bortskaffes sammen med andet husholdningsaffald. I stedet er det dit ansvar at bortskaffe affaldsudstyret ved at aflevere det på det rigtige bergegnede indsamlingssted med henblik på genbrug af elektrisk og elektronisk affaldsudstyr. Den separate indsamling og genbrug af dit affaldsudstyr vil hjælpe med at bevare naturlige ressourcer og sikre, at genbrug finder sted på en måde, der beskytter menneskers helbred samt miljøet. Hvis du vil vide mere om, hvor du kan aflevere dit affaldsudstyr til genbrug, kan du kontakte kommunen, det lokale renovationsvæsen eller den forretning, hvor du købte produktet.</p>
Nederlands	<p>Afvoer van afgedankte apparatuur door gebruikers in particuliere huishoudens in de Europese Unie</p> <p>Dit symbool op het product of de verpakking geeft aan dat dit product niet mag worden afgevoerd met het huishoudelijk afval. Het is uw verantwoordelijkheid uw afgedankte apparatuur af te leveren op een aangewezen inzamelpunt voor de verwerking van afgedankte elektrische en elektronische apparatuur. De gescheiden inzameling en verwerking van uw afgedankte apparatuur draagt bij tot het sparen van natuurlijke bronnen en tot di hergebruik van materiaal op een wijze die de volksgezondheid en het milieu beschermt. Voor meer informatie over waar u uw afgedankte apparatuur kunt inleveren voor recycling kunt u contact opnemen met het gemeentehuis in uw woonplaats, de reinigingsdienst of de winkel waar u het product hebt aangekocht.</p>
Eesti	<p>Eramajapidamistes kasutusel kõrvaldatava seadmete käitlemine Euroopa Liidus</p> <p>Kui tootel või toote pakendil on see sümbol, ei tohi seda tootele visata olmejäätmete hulka. Teie kohus on viia tarbetuks muutunud seade sellele ettenähtud elektri- ja elektroonikaseadmete utiliseerimiskohale. Utiliseeritava seadmete eraldi kogumine ja käitlemine aitab säästa loodusvarasid ning lagada, et käitlemine toimub inimeste tervisele ja keskkonnale ohutult. Lisateavet selle kohta, kuidas saate utiliseeritava seadme käitlemiseks viia, saate küsida kohalikul omavalitsusel, olmejäätmete utiliseerimispunktil või kaupluses, kust te seadme ostsite.</p>
Suomi	<p>Hävitettävien laitteiden käsittely kotitalouksissa Euroopan unionin alueella</p> <p>Tämä tuotteen tai sen pakkauskassan oleva merkintä osoittaa, että tuotetta ei saa hävittää talousjätteen mukana. Käyttäjän velvollisuus on huolehtia siitä, että hävitettävä laite toimitetaan sähkö- ja elektronikkalaiteromun keräyspisteeseen. Hävitettävien laitteiden erillinen keräys ja kierrätys säästää luonnonvaroja. Näin toimimalla varmistetaan myös, että kierrätys tapahtuu tavalla, joka suojaa ihmisten terveyttä ja ympäristöä. Saat tarvittaessa lisätietoja jätteen kierrätyspaikoista paikallisilta viranomaisilta, jätteenhoitilta tai tuotteen jällemyyjältä.</p>
Ελληνικά	<p>Απορρίψη χρηστών συσκευών στην Ευρωπαϊκή Ένωση</p> <p>Το σύμβολο στον εξοπλισμό ή στη συσκευασία του υποδηλώνει ότι το προϊόν αυτό δεν πρέπει να πεταχτεί μαζί με άλλα οικιακά απορρίμματα. Αντίθετα, ευθύνει σας είναι να απορρίψετε τις άχρηστες συσκευές σε μια καθορισμένη μονάδα συλλογής απορριμμάτων για την ανακύκλιση χρηστών ηλεκτρικού και ηλεκτρονικού εξοπλισμού. Η χωριστή συλλογή και ανακύκλιση των χρηστών συσκευών στη συμβολή στη διατήρηση των φυσικών πόρων και στη διασφάλιση ότι θα ανακυκλωθούν με τέτοιο τρόπο, ώστε να προστατευτεί το περιβάλλον και να μην επηρεαστεί η υγεία των ανθρώπων. Για περισσότερες πληροφορίες σχετικά με το πού μπορείτε να απορρίψετε τις άχρηστες συσκευές για ανακύκλιση, επικοινωνήστε με τις κατά τόπους αρμόδιες αρχές ή με το κατάστημα από το οποίο αγοράσατε το προϊόν.</p>
Magyar	<p>A hulladékkanyagok kezelése a magánháztartásokban az Európai Unióban</p> <p>Ez a szimbólum, amely a termék vagy annak csomagolásán van feltüntetve, azt jelzi, hogy a termék nem kezelhető együtt az egyéb háztartási hulladékkal. Az Ön feladata, hogy a készülék hulladékkanyagait eljuttassa olyan kijelölt gyűjtőhelyre, amely az elektronikus hulladékkanyagok és az elektronikus berendezések újrahasznosításával foglalkozik. A hulladékkanyagok elkülönített gyűjtése és újrahasznosítása hozzájárul a természeti erőforrások megőrzéséhez, egyáltalán az is biztosítja, hogy a hulladéki újrahasznosítás az egészségesre és környezetet nem ártalmas módon történik. Ha tájékoztatást szeretne kapni azokról a helyekről, ahol leadhatja újrahasznosításra a hulladékkanyagokat, forduljon a helyi önkormányzathoz, a háztartási hulladék begyűjtésével foglalkozó vállalatához vagy a termék forgalmazójához.</p>
Latviski	<p>Lietotāju atbrīvošanās no nederīgām ierīcēm privātaj mājoklī atliekams iebraucamības</p> <p>Šis simbols uz ierīces vai tās iepakojuma norāda, ka šo ierīci nedrīkst iznest kopā ar pārējām mājaiemcības atkritumiem. Jūs esat atbildīgs par atbrīvošanos no nederīgās ierīces, to nododot norādītajā savākšanas vieta, lai iktu veikta nederīgā elektriskā un elektroniskā aprīkojuma atbrīvošana otrreizējā pārstrādē. Speciāla nederīgās ierīces savākšana un otrreizējā pārstrāde palīdz taupīt dabas resursus un nodrošina tīdu otrreizējo pārstrādi, kas sargā cilvēku veselību un apkārtni vidi. Lai iegūtu papildu informāciju par to, kur otrreizēji pārstrādēt vai nogādāt nederīgo ierīci, lūdz, sazinieties ar vietējo pašvaldību, mājaiemcības atkritumu savākšanas dienestu vai veikalu, kurā iegādājāties šo ierīci.</p>
Lietuviškai	<p>Europos Sąjungos vartotojų ir privačių namų ūkiu atliekamų įrangos išmetimas</p> <p>Šis simbolis ant produkto arba jo pakuotės nurodo, kad produktas negali būti išmestas kartu su kitomis namų ūkiu atliekamomis. Jūs privalote išmesti savo atliekamą įrangą atitinkamą į ją atliekamoms elektronikos ir elektro įrangos perdirbimo punktus. Jei atliekamą įrangą bus atskiri surenkami ir perdirbama, bus išsaugomi natūralūs išteklių ir užtikrinama, kad įranga yra perdirbta žmogaus sveikatai ir gamtai saugojančiu būdu. Dėl informacijos apie tai, kur galite išmesti atliekamą perdirbti skirtą įrangą kreipkitės į atitinkamą vietos tarnybą, namų ūkiu atliekamų įrangos arba į perdirbtuvę, kurioje pirkote produktą.</p>
Polski	<p>Utylizacja zużytego sprzętu przez użytkowników domowych w Unii Europejskiej</p> <p>Symbol ten umieszczony na produkcie lub opakowaniu oznacza, że tego produktu nie należy wyrzucać razem z innymi odpadami domowymi. Użytkownik jest odpowiedzialny za dostarczenie zużytego sprzętu do wyznaczonego punktu gromadzenia zużytych urządzeń elektrycznych i elektronicznych. Gromadzenie osobno i recykling tego typu odpadów przyczynia się do ochrony zasobów naturalnych i jest bezpieczny dla zdrowia i środowiska naturalnego. Dalsze informacje na temat sposobu utylizacji zużytych urządzeń można uzyskać u odpowiednich władz lokalnych, w przedsiębiorstwach zajmujących się usuwaniem odpadów lub w miejscach zakupu produktu.</p>
Português	<p>Descarte de equipamentos por usuários em residências da União Europeia</p> <p>Este símbolo no produto ou no embalagem indica que o produto não pode ser descartado junto com o lixo doméstico. No entanto, é sua responsabilidade levar os equipamentos a serem descartados a um ponto de coleta designado para a reciclagem de equipamentos eletro-eletrônicos. A coleta separada e a reciclagem dos equipamentos no momento do descarte ajudam na conservação dos recursos naturais e garantem que os equipamentos serão reciclados de forma a proteger a saúde das pessoas e o meio ambiente. Para obter mais informações sobre onde descartar equipamentos para reciclagem, entre em contato com o escritório local de sua cidade, o serviço de limpeza pública de seu bairro ou a loja em que adquiriu o produto.</p>
Slovenčina	<p>Postup pozitvovalov v krajinskih Evropskej unije pri vyhazovanju zariadenia v domácom používaní do odpadu</p> <p>Tento symbol na produkte alebo na jeho obale znamená, že nesmie byť vyhodzený s iným komunálnym odpadom. Namiesto toho máte povinnos odovzdať toto zariadenie na zbernom mieste, kde sa zabezpečuje recyklácia elektrických a elektronických zariadení. Separovány zber a recyklácia zariadenia určeného na odpad pomôžu chrániť prírodné zdroje a zabezpečí taký spôsob recyklácie, ktorý bude chráni ľudské zdravie a životné prostredie. Ďalšie informácie o separovaní zberu a recyklácii získate na miestnom obecnom úrade, vo firme zberajúcej zber vášho komunálneho odpadu alebo v predajni, kde ste produkt kúpili.</p>
Slovenski	<p>Ravnanje z odpadno opremo v gospodinjstvih znotraj Evropske unije</p> <p>Ta znak na izdelku ali embalaži izdelka pomeni, da izdelka ne smeje odlagati skupaj z drugimi gospodinjstvi odpadki. Odpadno opremo ste dolžni oddati na določenem zbirnem mestu za recikliranje odpadne električne in elektronske opreme. Z ločenim zbiranjem in recikliranjem odpadne opreme ob odlaganju boste pomagali ohraniti naravne vire in zagotovili, da bo odpadna oprema reciklirana tako, da se varuje zdravje ljudi in okolje. Več informacij o mestih, kjer lahko oddate odpadno opremo za recikliranje, lahko dobite na občini, v komunalnem podjetju ali trgovini, kjer ste izdelek kupili.</p>
Svenska	<p>Kassering av förbrukningsmaterial, för hem- och privat användare i EU</p> <p>Detta symbol eller produktförpackningarna med den här symbolen betyder med vanligt hushållsaffall. I stället har du ansvar för att produkten lämnas till en behörig återvinningstjänst för hantering av el- och elektronprodukter. Genom att lämna kasserade produkter till återvinning hjälper du till att bevara våra gemensamma naturresurser. Dessutom skyddas både människor och miljön när produkter återvinns på rätt sätt. Kommunala myndigheter, sophanteringsföretag eller butiker där varan köptes kan ge mer information om var du lämnar kasserade produkter för återvinning.</p>

Regulatory notices

The HP All-in-One meets product requirements from regulatory agencies in your country/region.

This section contains the following topics:

- [FCC statement](#)
- [Notice to users in Australia](#)
- [Notice to users in Korea](#)
- [VCCI \(Class B\) compliance statement for users in Japan](#)
- [Notice to users in Japan about power cord](#)
- [Geräuschemission](#)

FCC statement

The United States Federal Communications Commission (in 47 CFR 15.105) has specified that the following notice be brought to the attention of users of this product.

This equipment has been tested and found to comply with the limits for a Class B digital device, pursuant to part 15 of the FCC Rules. These limits are designed to provide reasonable protection against harmful interference in a residential installation. This equipment generates, uses, and can radiate radio frequency energy, and, if not installed and used in accordance with the instructions, may cause harmful interference to radio communications. However, there is no guarantee that interference will not occur in a particular installation. If this equipment does cause harmful interference to radio or television reception, which can be determined by turning the equipment off and on, the user is encouraged to try to correct the interference by one or more of the following measures:

- Reorient or relocate the receiving antenna.
- Increase the separation between the equipment and receiver.
- Connect the equipment into an outlet on a circuit different from that to which the receiver is connected.
- Consult the dealer or an experienced radio/TV technician for help.

This device complies with Part 15 of the FCC Rules. Operation is subject to the following two conditions: (1) this device may not cause harmful interference, and (2) this device must accept any interference received, including interference that may cause undesired operation.

Modifications (part 15.21): The FCC requires the user to be notified that any changes or modifications made to this device that are not expressly approved by HP may void the user's authority to operate the equipment.

For further information, contact the Manager of Corporate Product Regulations, Hewlett-Packard Company, 3000 Hanover Street, Palo Alto, CA 94304, (650) 857-1501.

Notice to users in Australia



This equipment complies with Australian EMC requirements.

Notice to users in Korea

사용자 안내문(B급 기기)

이 기기는 비업무용으로 전자파 적합 등록을 받은 기기로서, 주거지역에서는 물론 모든 지역에서 사용할 수 있습니다.

VCCI (Class B) compliance statement for users in Japan

この装置は、情報処理装置等電波障害自主規制協議会（VCCI）の基準に基づくクラスB情報技術装置です。この装置は、家庭環境で使用することを目的としていますが、この装置がラジオやテレビジョン受信機に近接して使用されると受信障害を引き起こすことがあります。
取り扱い説明書に従って正しい取り扱いをして下さい。

Notice to users in Japan about power cord

製品には、同梱された電源コードをお使い下さい。
同梱された電源コードは、他の製品では使用出来ません。

Geräuschemission

Geräuschemission

LpA < 70 dB am Arbeitsplatz im Normalbetrieb nach DIN 45635 T.19