

Samsung ML-2850 Series
Monochrome Laser Printer



User's Guide



This manual is provided for information purposes only. All information included herein is subject to change without notice. Samsung Electronics is not responsible for any direct or indirect damages, arising from or related to the use of this manual.

© 2007 Samsung Electronics Co., Ltd. All rights reserved.

- ML-2850D and ML-2851ND are model names of Samsung Electronics Co., Ltd.
- Samsung and Samsung logo are trademarks of Samsung Electronics Co., Ltd.
- IBM and IBM PC are trademarks of International Business Machines Corporation.
- PCL and PCL 6 are trademarks of Hewlett-Packard company.
- Microsoft, Windows, Windows Vista, Windows 7 and Windows 2008 Server R2 are either registered trademarks or trademarks of Microsoft Corporation.
- PostScript 3 is a trademark of Adobe System, Inc.
- UFST® and MicroType™ are registered trademarks of Monotype Imaging Inc.
- TrueType, LaserWriter, and Macintosh are trademarks of Apple Computer, Inc.
- All other brand or product names are trademarks of their respective companies or organizations.
- Open source information is available in Samsung website, www.samsung.com.
- Refer to the 'LICENSE.txt' file in the provided CD-ROM for the open source license information.

Contact SAMSUNG WORLD WIDE

If you have any comments or questions regarding Samsung products, contact the Samsung customer care center.

COUNTRY/ REGION	CUSTOMER CARE CENTER	WEB SITE
ARGENTINE	0800-333-3733	www.samsung.com/ar
AUSTRALIA	1300 362 603	www.samsung.com/au
AUSTRIA	0810-SAMSUNG (7267864, € 0.07/min)	www.samsung.com/at
BELARUS	810-800-500-55-500	www.samsung.ua www.samsung.com/ua_ru
BELGIUM	02 201 2418	www.samsung.com/be (Dutch) www.samsung.com/be_fr (French)
BRAZIL	0800-124-421 4004-0000	www.samsung.com/br
CANADA	1-800-SAMSUNG (726- 7864)	www.samsung.com/ca
CHILE	800-SAMSUNG (726-7864)	www.samsung.com/cl
CHINA	400-810-5858 010-6475 1880	www.samsung.com/cn
COLOMBIA	01-8000112112	www.samsung.com.co
COSTA RICA	0-800-507-7267	www.samsung.com/latin
CZECH REPUBLIC	800-SAMSUNG (800- 726786) Samsung Zrt., česká organizační složka, Oasis Florenc, Sokolovská394/17, 180 00, Praha 8	www.samsung.com/cz
DENMARK	8-SAMSUNG (7267864)	www.samsung.com/dk
ECUADOR	1-800-10-7267	www.samsung.com/latin
EL SALVADOR	800-6225	www.samsung.com/latin
ESTONIA	800-7267	www.samsung.com/ee
KAZAKHSTAN	8-10-800-500-55-500	www.samsung.com/kz_ru
KYRGYZSTAN	00-800-500-55-500	
FINLAND	30-6227 515	www.samsung.com/fi
FRANCE	01 4863 0000	www.samsung.com/fr
GERMANY	01805 - SAMSUNG (726- 7864 € 0,14/min)	www.samsung.de
GUATEMALA	1-800-299-0013	www.samsung.com/latin
HONDURAS	800-7919267	www.samsung.com/latin
HONG KONG	3698-4698	www.samsung.com/hk www.samsung.com/hk_en/
HUNGARY	06-80-SAMSUNG (726- 7864)	www.samsung.com/hu

COUNTRY/ REGION	CUSTOMER CARE CENTER	WEB SITE
INDIA	3030 8282 1800 110011 1800 3000 8282	www.samsung.com/in
INDONESIA	0800-112-8888	www.samsung.com/id
ITALIA	800-SAMSUNG (726-7864)	www.samsung.com/it
JAMAICA	1-800-234-7267	www.samsung.com/latin
JAPAN	0120-327-527	www.samsung.com/jp
LATVIA	8000-7267	www.samsung.com/lv
LITHUANIA	8-800-77777	www.samsung.com/lt
LUXEMBURG	02 261 03 710	www.samsung.com/lu
MALAYSIA	1800-88-9999	www.samsung.com/my
MEXICO	01-800-SAMSUNG (726- 7864)	www.samsung.com/mx
MOLDOVA	00-800-500-55-500	www.samsung.ua www.samsung.com/ua_ru
NETHERLANDS	0900-SAMSUNG (0900- 7267864) (€ 0,10/min)	www.samsung.com/nl
NEW ZEALAND	0800 SAMSUNG (0800 726 786)	www.samsung.com/nz
NICARAGUA	00-1800-5077267	www.samsung.com/latin
NORWAY	3-SAMSUNG (7267864)	www.samsung.com/no
PANAMA	800-7267	www.samsung.com/latin
PHILIPPINES	1800-10-SAMSUNG (726- 7864) 1-800-3-SAMSUNG (726- 7864) 1-800-8-SAMSUNG (726- 7864) 02-5805777	www.samsung.com/ph
POLAND	0 801 1SAMSUNG (172678) 022-607-93-33	www.samsung.com/pl
PORTUGAL	80820-SAMSUNG (726- 7864)	www.samsung.com/pt
PUERTO RICO	1-800-682-3180	www.samsung.com/latin
REP. DOMINICA	1-800-751-2676	www.samsung.com/latin
EIRE	0818 717 100	www.samsung.com/ie
RUSSIA	8-800-555-55-55	www.samsung.ru
SINGAPORE	1800-SAMSUNG (726- 7864)	www.samsung.com/sg
SLOVAKIA	0800-SAMSUNG (726- 7864)	www.samsung.com/sk

COUNTRY/ REGION	CUSTOMER CARE CENTER	WEB SITE
SOUTH AFRICA	0860 SAMSUNG (726-7864)	www.samsung.com/za
SPAIN	902-1-SAMSUNG(902 172 678)	www.samsung.com/es
SWEDEN	0771 726 7864 (SAMSUNG)	www.samsung.com/se
SWITZERLAND	0848-SAMSUNG (7267864, CHF 0.08/min)	www.samsung.com/ch
TADJIKISTAN	8-10-800-500-55-500	
TAIWAN	0800-329-999	www.samsung.com/tw
THAILAND	1800-29-3232 02-689-3232	www.samsung.com/th
TRINIDAD & TOBAGO	1-800-SAMSUNG (726-7864)	www.samsung.com/latin
TURKEY	444 77 11	www.samsung.com/tr
U.A.E	800-SAMSUNG (726-7864) 8000-4726	www.samsung.com/ae
U.K	0845 SAMSUNG (726-7864)	www.samsung.com/uk
U.S.A	1-800-SAMSUNG (7267864)	www.samsung.com/us
UKRAINE	8-800-502-0000	www.samsung.ua www.samsung.com/ua_ru
UZBEKISTAN	8-10-800-500-55-500	www.samsung.com/kz_ru
VENEZUELA	0-800-100-5303	www.samsung.com/latin
VIETNAM	1 800 588 889	www.samsung.com/vn

CONTENTS

1. Introduction	
Special features	1.1
Printer overview	1.2
Front view	1.2
Rear view	1.3
Control panel overview	1.3
Understanding the LEDs	1.3
Finding more information	1.4
Setting up the hardware	1.4
Altitude adjustment	1.5
Changing the font setting	1.6
2. Basic setup	
Printing a demo page	2.1
Using toner save mode	2.1
3. Software overview	
Supplied software	3.1
Printer driver features	3.1
System requirements	3.2
4. Loading print media	
Selecting print media	4.1
Supported sizes of paper	4.2
Guidelines for selecting and storing print media	4.3
Loading paper	4.4
Using the tray 1 or the optional tray 2	4.5
Changing the size of the paper in the tray 1	4.5
Using manual feeder	4.6
Printing with a prescribed paper size	4.7
Knowing an output location	4.7
5. Network setup(ML-2851ND only)	
Introduction	5.1
Supported operating systems	5.1
Using SetIP program	5.1
6. Basic printing	
Printing a document	6.1
Canceling a print job	6.1
7. Ordering supplies and accessories	
Toner cartridge	7.1
Accessory	7.1
How to purchase	7.1

8. Maintenance

Cleaning the printer	8.1
Cleaning the outside of the printer	8.1
Cleaning the inside of the printer	8.1
Maintaining the toner cartridge	8.2
Redistributing toner cartridge	8.2
Replacing the toner cartridge	8.3
Printing a configuration page	8.4
Maintenance parts	8.4

9. Troubleshooting

Clearing paper jams	9.1
In the paper feed area	9.1
Around the toner cartridge	9.2
In the paper exit area	9.3
In the duplex unit area	9.3
Tips for avoiding paper jams	9.4
Troubleshooting checklist	9.5
Solving general printing problems	9.5
Solving print quality problems	9.7
Common Windows problems	9.9
Common PostScript problems	9.10
Common Linux problems	9.10
Common Macintosh problems	9.11

10. Installing accessories

Precautions to take when installing accessories	10.1
Installing a memory module	10.1
Activating the added memory in the PS printer properties	10.2

11. Specifications

Printer specifications	11.1
------------------------------	------

Safety and Regulatory Information

Important Precautions and Safety Information

When using this machine, these basic safety precautions should always be followed to reduce risk of fire, electric shock, and injury to people:

- 1 Read and understand all instructions.
- 2 Use common sense whenever operating electrical appliances.
- 3 Follow all warnings and instructions marked on the machine and in the literature accompanying the machine.
- 4 If an operating instruction appears to conflict with safety information, heed the safety information. You may have misunderstood the operating instruction. If you cannot resolve the conflict, contact your sales or service representative for assistance.
- 5 Unplug the machine from the AC wall socket before cleaning. Do not use liquid or aerosol cleaners. Use only a damp cloth for cleaning.
- 6 Do not place the machine on an unstable cart, stand or table. It may fall, causing serious damage.
- 7 Your machine should never be placed on, near or over a radiator, heater, air conditioner or ventilation duct.
- 8 Do not allow anything to rest on the power cable. Do not locate your machine where the cords will be abused by persons walking on them.
- 9 Do not overload wall outlets and extension cords. This can diminish performance, and may result in the risk of fire or electric shock.
- 10 Do not allow pets to chew on the AC power or PC interface cords.
- 11 Never push objects of any kind into the machine through case or cabinet openings. They may touch dangerous voltage points, creating a risk of fire or shock. Never spill liquid of any kind onto or into the machine.
- 12 To reduce the risk of electric shock, do not disassemble the machine. Take it to a qualified service technician when repair work is required. Opening or removing covers may expose you to dangerous voltages or other risks. Incorrect reassembly could cause electric shock when the unit is subsequently used.
- 13 Unplug the machine from the PC and AC wall outlet, and refer servicing to qualified service personnel under the following conditions:
 - When any part of the power cord, plug, or connecting cable is damaged or frayed.
 - If liquid has been spilled into the machine.
 - If the machine has been exposed to rain or water.
 - If the machine does not operate properly after instructions have been followed.
 - If the machine has been dropped, or the cabinet appears damaged.
 - If the machine exhibits a sudden and distinct change in performance.
- 14 Adjust only those controls covered by the operating instructions. Improper adjustment of other controls may result in damage, and may

require extensive work by a qualified service technician to restore the machine to normal operation.

- 15 Avoid using this machine during a lightning storm. There may be a remote risk of electric shock from lightning. If possible, unplug the AC power for the duration of the lightning storm.
- 16 If you continuously print multiple pages, the surface of the output tray may become hot. Be careful not to touch the surface, and keep children away from the surface.
- 17 The Power cord supplied with your machine should be used for safe operation. If you are using a cord which is longer than 2 m with 110 V machine, then it should be 16 AWG* or bigger.
- 18 SAVE THESE INSTRUCTIONS.

Environmental and Safety Consideration

Laser Safety Statement

The printer is certified in the U.S. to conform to the requirements of DHHS 21 CFR, chapter 1 Subchapter J for Class I(1) laser products, and elsewhere, is certified as a Class I laser product conforming to the requirements of IEC 825.

Class I laser products are not considered to be hazardous. The laser system and printer are designed so there is never any human access to laser radiation above a Class I level during normal operation, user maintenance, or prescribed service condition.

Warning

Never operate or service the printer with the protective cover removed from Laser/Scanner assembly. The reflected beam, although invisible, can damage your eyes.

* AWG: American Wire Gauge

When using this product, these basic safety precautions should always be followed to reduce risk of fire, electric shock, and injury to persons:

	CAUTION - CLASS 3B LASER RADIATION WHEN OPEN AVOID EXPOSURE TO THE BEAM.
	DANGER - LASER RADIATION AVOID DIRECT EXPOSURE TO BEAM.
	DANGER - RADIATIONS INVISIBLES DU LASER EN CAS D'OUVERTURE. EVITER TOUTE EXPOSITION DIRECTE AU FAISCEAU.
	VORSICHT - UNSICHTBARE LASERSTRAHLUNG, WENN ABDECKUNG GEÖFFNET. NICHT DEM STRAHL AUSSETZEN.
	ATTENZIONE - RADIAZIONE LASER INVISIBILE IN CASO DI APERTURA. EVITARE L'ESPOSIZIONE AL FASCIO.
	PRECAUCIÓN - RADIACIÓN LASER INVISIBLE CUANDO SE ABRE. EVITAR EXPONERSE AL RAYO.
	PERIGO - RADIACÃO LASER INVISÍVEL AO ABRIR. EVITE EXPOSIÇÃO DIRECTA AO FEIXE.
	GEVAAR - ONZICHTBARE LASERSTRALLEN BIJ GEOPENDE KLEP. DEZE KLEP NIET OPENEN.
	ADVARSEL - USYNLIG LASERSTRÅLNING VED ÅBNING. UNDGÅ UDSÆTTTELSE FOR STRÅLNING.
	ADVARSEL - USYNLIG LASERSTRÅLNING NÅR DEKSEL ÅPNES. UNNGÅ EKSPONERING FOR STRÅLEN.
VARNING - OSYNLIG LASERSTRÅLNING NÅR DENNA DEL ÄR ÖPPEN. STRÅLEN ÄR FARLIG.	
VAROITUS - NÄKYMÄTÖNTÄ LASERSÄTEILYÄ AVATTAESSA. VARO SUORAA ALTISTUMISTA SÄTEELLE.	
注意 - 严禁揭开此盖, 以免激光泄露灼伤	
주 의 - 이 덮개를 열면 레이저광에 노출될 수 있으므로 주의하십시오.	

Ozone Safety



During normal operation, this machine produces ozone. The ozone produced does not present a hazard to the operator. However, it is advisable that the machine be operated in a well ventilated area.

If you need additional information about ozone, please contact your nearest Samsung dealer.

Power Saver



This printer contains advanced energy conservation technology that reduces power consumption when it is not in active use.

When the printer does not receive data for an extended period of time, power consumption is automatically lowered.

ENERGY STAR and the ENERGY STAR mark are registered U.S. marks.

For more information on the ENERGY STAR program see <http://www.energystar.gov>

Recycling



Please recycle or dispose of packaging materials for this product in an environmentally responsible manner.

Correct Disposal of This Product (Waste Electrical & Electronic Equipment)

(Applicable in the European Union and other European countries with separate collection systems)



This marking shown on the product or its literature, indicates that it should not be disposed with other household wastes at the end of its working life. To prevent possible harm to the environment or human health from uncontrolled waste disposal, please separate this from other types of wastes and recycle it responsibly to promote the sustainable reuse of material resources.

Household users should contact either the retailer where they purchased this product, or their local government office, for details of where and how they can take this item for environmentally safe recycling.

Business users should contact their supplier and check the terms and conditions of the purchase contract. This product should not be mixed with other commercial wastes for disposal.

Radio Frequency Emissions

FCC Regulations

This device complies with Part 15 of the FCC Rules. Operation is subject to the following two conditions:

- This device may not cause harmful interference, and
- This device must accept any interference received, including interference that may cause undesired operation.

This device has been tested and found to comply with the limits for a Class B digital device, pursuant to Part 15 of the FCC rules. These limits are designed to provide reasonable protection against harmful interference in a residential installation. This equipment generates, uses and can radiate radio frequency energy and, if not installed and used in accordance with the instructions, may cause harmful interference to radio communications. However, there is no guarantee that interference will not occur in a particular installation. If this equipment does cause harmful interference to radio or television reception, which can be determined by turning the equipment off and on, the user is encouraged to try to correct the interference by one or more of the following measures:

- Reorient or relocate the receiving antenna.
- Increase the separation between the equipment and receiver.
- Connect the equipment into an outlet on a circuit different from that to which the receiver is connected.
- Consult the dealer or an experienced radio/TV technician for help.

Caution:

Changes or modifications not expressly approved by the manufacturer responsible for compliance could void the user's authority to operate the equipment.

Canadian Radio Interference Regulations

This digital apparatus does not exceed the Class B limits for radio noise emissions from digital apparatus as set out in the interference-causing equipment standard entitled "Digital Apparatus", ICES-003 of the Industry and Science Canada.

Cet appareil numérique respecte les limites de bruits radioélectriques applicables aux appareils numériques de Classe B prescrites dans la norme sur le matériel brouilleur: "Appareils Numériques", ICES-003 édictée par l'Industrie et Sciences Canada.

Declaration of Conformity (European Countries)

Approvals and Certifications



The CE marking applied to this product symbolises Samsung Electronics Co., Ltd. Declaration of Conformity with the following applicable 93/68/EEC Directives of the European Union as of the dates indicated:

The declaration of conformity may be consulted at www.samsung.com/printer, go to Support > Download center and enter your printer name to browse the EuDoC.

January 1, 1995: Council Directive 73/23/EEC Approximation of the laws of the member states related to low voltage equipment.

January 1, 1996: Council Directive 89/336/EEC (92/31/EEC), approximation of the laws of the Member States related to electromagnetic compatibility.

March 9, 1999: Council Directive 1999/5/EC on radio equipment and telecommunications terminal equipment and the mutual recognition of their conformity.

A full declaration, defining the relevant Directives and referenced standards can be obtained from your Samsung Electronics Co., Ltd. representative.

Replacing the Fitted Plug (for UK Only)

Important

The mains lead for this machine is fitted with a standard (BS 1363) 13 amp plug and has a 13 amp fuse. When you change or examine the fuse, you must re-fit the correct 13 amp fuse. You then need to replace the fuse cover. If you have lost the fuse cover, do not use the plug until you have another fuse cover.

Please contact the people from you purchased the machine.

The 13 amp plug is the most widely used type in the UK and should be suitable. However, some buildings (mainly old ones) do not have normal 13 amp plug sockets. You need to buy a suitable plug adaptor. Do not remove the moulded plug.

Warning

If you cut off the moulded plug, get rid of it straight away.

You cannot rewire the plug and you may receive an electric shock if you plug it into a socket.

Important warning: You must earth this machine.

The wires in the mains lead have the following color code:

- Green and Yellow: Earth

- Blue: Neutral
- Brown: Live

If the wires in the mains lead do not match the colors marked in your plug, do the following:

You must connect the green and yellow wire to the pin marked by the letter "E" or by the safety 'Earth symbol' or colored green and yellow or green.

You must connect the blue wire to the pin which is marked with the letter "N" or colored black.

You must connect the brown wire to the pin which is marked with the letter "L" or colored red.

You must have a 13 amp fuse in the plug, adaptor, or at the distribution board.

1 Introduction

Congratulations on the purchase of your printer!

This chapter includes:

- **Special features**
- **Printer overview**
- **Control panel overview**
- **Understanding the LEDs**
- **Finding more information**
- **Setting up the hardware**
- **Altitude adjustment**
- **Changing the font setting**

Special features

Your new printer is equipped with several special features that improve the print quality. You can:

Print with excellent quality and high speed



- You can print up to **1200 x 1200 dpi** effective output. See the Software Section.
- Your printer prints A4-sized paper at up to 28 ppm^a and letter-sized paper at up to 30 ppm. For duplex printing, your printer prints A4-sized paper at up to 14 ipm^b and letter-sized paper at up to 14.5 ipm.

Handle paper flexibly

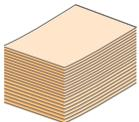

- Manual tray supports one sheet of envelopes, labels, transparencies, custom-sized materials, postcards and heavy paper.
- Standard 250-sheet tray supports plain paper.
- 150-sheet output tray supports convenient access.

Create professional documents

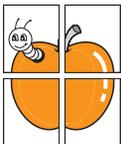

- Print **Watermarks**. You can customize your documents with words, such as “Confidential.” See the Software Section.
- Print **Booklets**. This feature enables you to easily print a document to create a book. Once printed, all you have to do is fold and staple the pages. See the Software Section.
- Print **Posters**. The text and pictures of each page of your document are magnified and printed across the sheet of paper and can then be taped together to form a poster. See the Software Section.

Save time and money



- Your printer allows you to use toner save mode to save toner. See the Software Section.
- You can print on both sides of the paper to save paper. See the Software Section.
- You can print multiple pages on a single sheet of paper to save paper. See the Software Section.
- You can use preprinted forms and letterhead with plain paper. See the Software Section.
- Your printer automatically **conserves electricity** by substantially reducing power consumption when not in use.

Expand the printer capacity

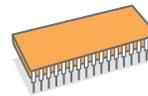

- Your printer has 32 MB of memory which can be expanded to **160 MB**. See page 10.1.
- You can add a 250-sheet optional tray 2 to your printer. This tray lets you add paper to the printer less often.

* Zoran IPS Emulation compatible with PostScript 3



• © Copyright 1995-2005, Zoran Corporation. All rights reserved. Zoran, the Zoran logo, IPS/PS3 and Onelimage are trademarks of Zoran Corporation.

* 136 PS3 fonts

• Contains UFST and MicroType from Monotype Imaging Inc.

Print in various environments

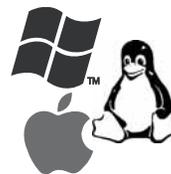

- You can print with various operating system such as Windows, Linux and Macintosh systems.
- Your printer comes with **USB** interfaces.

a. pages per minute
b. images per minute

Machine features

The table below lists a general overview of features supported by your printer.

(I: Installed, O: Option, NA: Not Available)

Features	ML-2850D	ML-2851ND
USB 2.0 (USB 2.0: Hi-Speed USB 2.0)	I	I
Network Interface (Ethernet 10/100 Base TX)	NA	I
PCL Emulation	I	I
PostScript Emulation	I	I
Duplex printing ^a	I	I

a. Printing on both sides of paper.

Printer overview

Front view

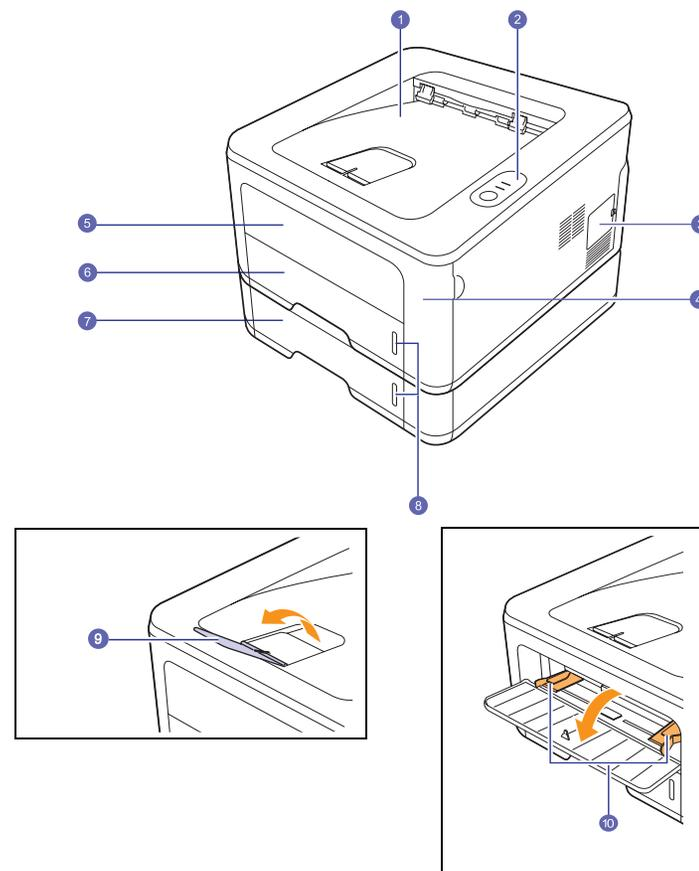

* The figure above shows an **ML-2851ND**.

1	output tray	6	tray 1
2	control panel	7	optional tray 2
3	control board cover	8	paper level indicator
4	front cover	9	output support
5	manual tray	10	manual tray paper width guides

Rear view

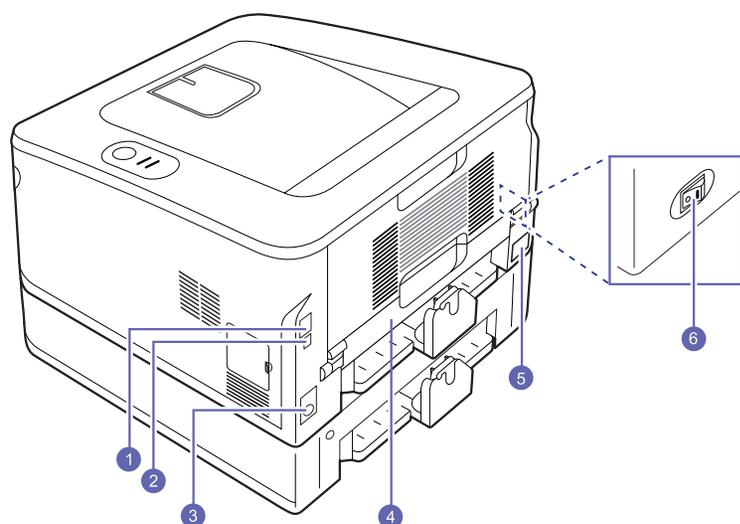

* The figure above shows an **ML-2851ND**.

1	network port^a	4	duplex unit
2	USB port	5	power receptacle
3	optional tray 2 cable connector	6	power switch

a. ML-2851ND only.

Control panel overview

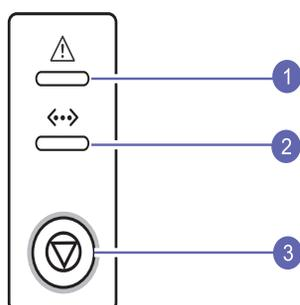

1	Error: Indicates the status of your printer. See page 9.5.
2	Online: Indicates the status of your printer. See page 9.5.
3	Cancel: Prints a demo page or configuration page. Cancels the print job. Makes the printer pick up the print media.

Understanding the LEDs

LED	Status		Description
	Color	State	
Error	Red	On	<ul style="list-style-type: none"> The cover is open. Close the cover. There is no paper in the tray. Load paper in the tray. The printer has stopped printing due to a major error. The toner cartridge is not installed. Install the toner cartridge. Your system has some problems. If this problem occurs, contact your service representative. A toner cartridge has almost reached its estimated cartridge life. It is recommended to replace the toner cartridge. (See "Replacing the toner cartridge" on page 8.3.)
		Blinking	<ul style="list-style-type: none"> A minor error is occurring and the printer is waiting for the error to be cleared. When the problem is cleared, the printer resumes printing. Small amount of toner is left in the cartridge. The estimated cartridge life of toner is close. Prepare a new cartridge for replacement. You may temporarily increase the printing quality by redistributing the toner. (See "Redistributing toner cartridge" on page 8.2.)
	Orange	On	<ul style="list-style-type: none"> A paper jam has occurred. To solve the problem, see page 9.1.
Online	Green	On	<ul style="list-style-type: none"> The printer is in power save mode. The printer is on-line and can receive data from the computer.
		Blinking	<ul style="list-style-type: none"> Blinks slowly indicates that the printer is receiving data from the computer. Blinks quickly indicates that the printer is printing data.

Finding more information

You can find information for setting up and using your printer from the following resources, either printed or onscreen.

Quick Install Guide



Provides information on setting up your printer, therefore, be sure to follow the instructions in the guide to get the printer ready.

Online User's Guide

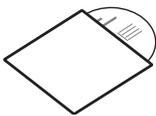

Provides you with step-by-step instructions for using your printer's full features, and contains information for maintaining your printer, troubleshooting, and installing accessories.

This user's guide also contains a Software Section providing you with information on how to print documents with your printer on various operating systems, and how to use the supplied software utilities.



Note

You can access the user's guides in other languages from the **Manual** folder on the printer driver CD.

Printer Driver Help



Provides you with help information on printer driver properties and instructions for setting up the properties for printing. To access a printer driver help screen, click **Help** from the printer properties dialog box.

Samsung Website

If you have Internet access, you can get help, support, printer drivers, manuals, and order information from the **Samsung** website, www.samsungprinter.com.

Setting up the hardware

This section shows the steps to set up the hardware which is explained in the Quick Install Guide. Make sure you read Quick Install Guide and complete following steps.

1 Select a stable location.

Select a level, stable place with adequate space for air circulation. Allow extra space to open covers and trays.

The area should be well-ventilated and away from direct sunlight or sources of heat, cold, and humidity. Do not set the machine close to the edge of your desk or table.

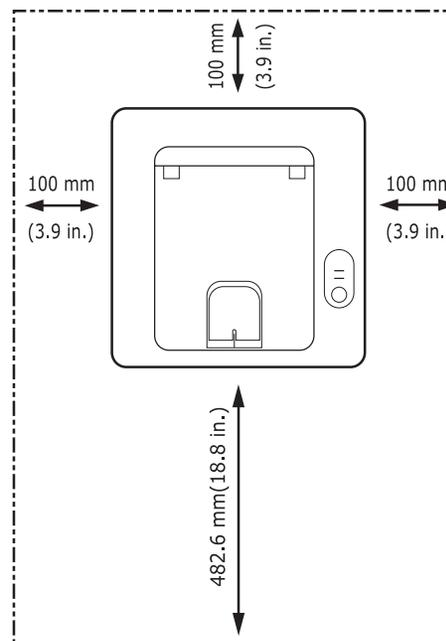

Printing is suitable for altitudes under 1,000 m (3,281 ft). Refer to the altitude setting to optimize your printing. See page 1.5 for more information.

Place the machine on a flat and stable surface for not letting it tilt more than 2 mm (0.08 inches). Otherwise, it may affect the printing quality.

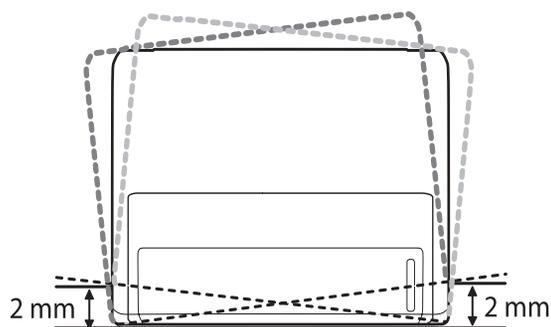

- 2 Unpack the machine and check all the enclosed items.
- 3 Remove the tape holding the machine tightly.
- 4 Install the toner cartridge.
- 5 Load paper. (See "Loading paper" on page 4.4.)
- 6 Make sure that all the cables are connected to the machine.
- 7 Turn the machine on.



Caution

- This equipment will be inoperable when mains power fails.
- When you move the machine, do not tilt or turn it upside down. Otherwise, the inside of the machine may be contaminated by toner, which can cause damage to the machine or bad printing quality.
- When the printer driver is in the installation process, the driver detects the locale information of your operating system, and sets the paper size for your machine. If you use the different Windows locale, you must change the paper size of your machine for matching your commonly used paper size. Open the printer properties to change the paper size.

Altitude adjustment

The print quality is affected by atmospheric pressure, which is determined by the height of the machine above sea level. The following information will guide you on how to set your machine to the best print quality or best quality of print.

Before you set the altitude value, find the altitude where you are using the machine.

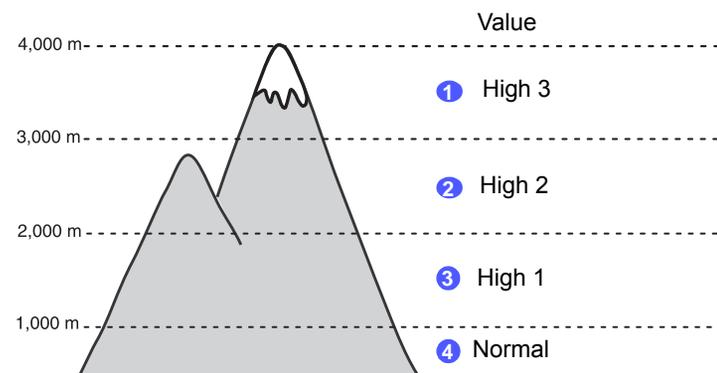

- 1 Ensure that you have installed the printer driver with the provided Printer Software CD.
- 2 Double-click the **Smart Panel** icon on the Windows task bar (or Notification Area in Linux). You can also click **Smart Panel** on the status bar in Mac OS X.
- 3 Click **Printer Setting**.
- 4 Click **Setting > Altitude Adjustment**. Select the appropriate value from the dropdown list, and then click **Apply**.



Note

If your machine is connected to a network, **SyncThru Web Service** screen appears automatically. Click **Machine Settings > Setup** (or **Machine Setup**) > **Altitude Adj.** Select the appropriate altitude value, and then click **Apply**.

Changing the font setting

Your machine has preset the font for your region or country.

If you want to change the font or set the font for special conditions such as DOS environment, you can change the font setting as follows:

- 1 Ensure that you have installed the printer driver from the provided software CD.
- 2 Double-click the **Smart Panel** icon on the Windows task bar (or Notification Area in Linux). You can also click **Smart Panel** on the status bar in Mac OS X.
- 3 Click **Printer Setting**.
- 4 Click **Emulation**.
- 5 Confirm if PCL is selected in **Emulation Setting**.
- 6 Click **Setting**.
- 7 Select your preferred font in the **Symbol set** list.
- 8 Click **Apply**.



Note

Following information shows the proper font list for corresponding languages.

- Russian: CP866, ISO 8859/5 Latin Cyrillic
- Hebrew: Hebrew 15Q, Hebrew-8, Hebrew-7 (Israel only)
- Greek: ISO 8859/7 Latin Greek, PC-8 Latin/Greek
- Arabic & Farsi: HP Arabic-8, Windows Arabic, Code Page 864, Farsi, ISO 8859/6 Latin Arabic
- OCR : OCR-A, OCR-B

2 Basic setup

This chapter includes:

- **Printing a demo page**
- **Using toner save mode**

Printing a demo page

After setting up your printer, print a demo page to make sure that the printer is operating correctly.

Press and hold the **Cancel** button for about 2 seconds.

A demo page prints out.

Using toner save mode

Toner save mode allows the printer to use less toner on each page. Activating this mode extends the life of your toner cartridge and reduces your cost per page beyond what one would experience in the normal mode, but it reduces print quality.

You can set the toner save mode from the printer properties window on your printer driver. See the Software Section.

3 Software overview

This chapter gives you an overview of the software that comes with your printer. Further details about installing and using the software are explained in the Software Section.

This chapter includes:

- **Supplied software**
- **Printer driver features**
- **System requirements**

Supplied software

After you have set up your machine and connected it to your computer, you must install the printer software. If you are a Windows or Macintosh OS, install the software from the supplied CD and if you are a Linux OS user, download the software from the Samsung website (www.samsung.com/printer) and install.

OS	Contents
Windows	<ul style="list-style-type: none"> • Printer driver: Use this driver to take full advantage of your printer's features. • Smart Panel: This program allows you to monitor the printer's status and alerts you when an error occurs during printing. • Printer Settings Utility: This program is automatically installed when you install the Smart Panel. • PCL6 driver: Use this driver to print documents in the PCL6, PCL5e language. • Postscript Printer Description (PPD) file: Use the PostScript driver to print documents with complex fonts and graphics in the PostScript language. • Set IP: Use this program to set your printer's TCP/IP addresses. • User's Guide in PDF
Linux	<ul style="list-style-type: none"> • Printer driver: Use this driver to run your printer from a Linux computer and print documents. • Smart Panel: This program allows you to monitor the printer's status and alerts you when an error occurs during printing.
Macintosh	<ul style="list-style-type: none"> • Printer driver: Use this driver to run your printer from a Macintosh computer and print documents. • Smart Panel: This program allows you to monitor the printer's status and alerts you when an error occurs during printing.

Printer driver features

Your printer drivers support the following standard features:

- Paper source selection
- Paper size, orientation and type
- Number of copies

In addition, you can use various special printing features. The following table shows a general overview of features supported by your printer drivers:

Feature	PCL 6	PostScript		
	Windows	Windows	Macintosh	Linux
Toner save	O	O	O	O
Print quality option	O	O	O	O
Poster printing	O	X	X	X
Multiple pages per sheet (N-up)	O	O	O	O (2, 4)
Fit to page printing	O	O	O	O
Scale printing	O	O	O	O
Watermark	O	X	X	X
Overlay	O	X	X	X

System requirements

Before you begin, ensure that your system meets the following requirements:

Windows

OPERATING SYSTEM	REQUIREMENT (RECOMMENDED)		
	CPU	RAM	FREE HDD SPACE
Windows 2000	Pentium II 400 MHz (Pentium III 933 MHz)	64 MB (128 MB)	600 MB
Windows XP	Pentium III 933 MHz (Pentium IV 1 GHz)	128 MB (256 MB)	1.5GB
Windows Server 2003	Pentium III 933 MHz (Pentium IV 1 GHz)	128 MB (512 MB)	1.25 GB to 2 GB
Windows Server 2008	Pentium IV 1 GHz (Pentium IV 2 GHz)	512 MB (2048 MB)	10 GB
Windows Vista	Pentium IV 3 GHz	512 MB (1024 MB)	15 GB
Windows 7	Pentium IV 1 GHz 32-bit or 64-bit processor or higher	1 GB (2 GB)	16 GB
	<ul style="list-style-type: none"> Support for DirectX 9 graphics with 128 MB memory(to enable the Aero theme). DVD-R/W Drive 		
Windows Server 2008 R2	Pentium IV 1 GHz(x86) or 1.4GHz(x64) processors(2GHz or faster)	512 MB (2048 MB)	10 GB



Note

Internet Explorer 5.0 or higher is the minimum requirement for all Windows operating systems.

Users who have an administrator right can install the software.

Linux

Item	Requirements
Operating system	Various Linux OS including <ul style="list-style-type: none"> Red Hat 8 ~ 9 Fedora Core 1 ~ 4 Mandrake 9.2 ~ 10.1 SuSE 8.2 ~ 9.2
Processor	Pentium IV 1 GHz or higher
RAM	256 MB or higher
Free disk page	1 GB or higher
Software	<ul style="list-style-type: none"> Linux Kernel 2.4 or higher Glibc 2.2 or higher CUPS

Macintosh

OPERATING SYSTEM	REQUIREMENT (RECOMMENDED)		
	CPU	RAM	FREE HDD SPACE
Mac OS X 10.4 or lower	<ul style="list-style-type: none"> Power PC G4/G5 Intel processors 	<ul style="list-style-type: none"> 128 MB for a Power PC based Mac (512 MB) 512 MB for an Intel based Mac (1 GB) 	1 GB
Mac OS X 10.5	<ul style="list-style-type: none"> 867MHz or faster Power PC G4 /G5 Intel processors 	512 MB (1 GB)	1 GB
Mac OS X 10.6	<ul style="list-style-type: none"> Intel processors 	1 GB (2 GB)	1 GB

4 Loading print media

This chapter will help you understand the types of paper you can use with your printer and how to properly load paper in the different paper trays for the best print quality.

This chapter includes:

- **Selecting print media**
- **Loading paper**
- **Printing with a prescribed paper size**
- **Knowing an output location**

Selecting print media

You can print on a variety of print media, such as plain paper, envelopes, labels, and transparencies. Always use print media that meet the guidelines for use with your printer. Print media that does not meet the guidelines outlined in this user's guide may cause the following problems:

- Poor print quality
- Increased paper jams
- Premature wear output trayn the machine.

Properties, such as weight, composition, grain, and moisture content, are important factors that affect the machine's performance and the output quality. When you choose print materials, consider the following:

- The type, size and weight of the print media for your machine are described later in this section.
- Desired outcome: The print media you choose should be appropriate for your project.
- Brightness: Some print media are whiter than others and produce sharper, more vibrant images.
- Surface smoothness: The smoothness of the print media affects how crisp the printing looks on the paper.



Notes

- Some print media may meet all of the guidelines in this section and still not produce satisfactory results. This may be the result of improper handling, unacceptable temperature and humidity levels, or other variables over which Samsung has no control.
- Before purchasing large quantities of print media, ensure that it meets the requirements specified in this user's guide.



Caution

- Using print media that does not meet these specifications may cause problems, requiring repairs. Such repairs are not covered by Samsung's warranty or service agreements.

Supported sizes of paper

Type	Size	Dimensions	Weight ^a	Capacity ^b
Plain paper	Letter	216 x 279 mm (8.5 x 11 inches)	<ul style="list-style-type: none"> • 60 to 105 g/m² (16 to 28 lb bond) for the tray • 60 to 163 g/m² (16 to 43 lb bond) for the manual feed 	<ul style="list-style-type: none"> • 250 sheets of 75 g/m² (20 lb bond) paper for the tray • 1 sheet for manual feeding in the tray 1
	Legal	216 x 356 mm (8.5 x 14 inches)		
	Folio	216 x 330.2 mm (8.5 x 13 inches)		
	Oficio	216 x 343 mm (8.5 x 13.5 inches)		
	A4	210 x 297 mm (8.26 x 11.69 inches)		
	JIS B5	182 x 257 mm (7.18 x 10.12 inches)		
	ISO B5	176 x 250 mm (6.93 x 9.84 inches)		
	Executive	184 x 267 mm (7.25 x 10.5 inches)		
	A5	148 x 210 mm (5.82 x 8.26 inches)		
	A6	105 x 148 mm (4.13 x 5.82 inches)		
Envelope	Envelope B5	176 x 250 mm (6.93 x 9.84 inches)	75 to 90 g/m ² (20 to 24 lb)	1 sheet for manual feeding in the tray 1
	Envelope Monarch	98.4 x 190.5 mm (3.88 x 7.5 inches)		
	Envelope COM-10	105 x 241 mm (4.12 x 9.5 inches)		
	Envelope DL	110 x 220 mm (4.33 x 8.66 inches)		
	Envelope C5	162 x 229 mm (6.38 x 9.02 inches)		
	Envelope C6	114 x 162 mm (4.49 x 6.38 inches)		
Transparency	Letter, A4	Refer to the Plain paper section	138 to 146 g/m ²	1 sheet for manual feeding in the tray 1
Labels	Letter, Legal, Folio, Oficio, A4, JIS B5, ISO B5, Executive, A5, A6	Refer to the Plain paper section	120 to 150 g/m ² (32 to 40 lb)	1 sheet for manual feeding in the tray 1
Card stock	Letter, Legal, Folio, Oficio, A4, JIS B5, ISO B5, Executive, A5, A6	Refer to the Plain paper section	60 to 163 g/m ² (16 to 43 lb)	1 sheet for manual feeding in the tray 1
Minimum size (custom)		76 x 127 mm (3.86 x 5.83 inches)	60 to 163 g/m ² (16 to 43 lb bond)	1 sheet for manual feeding in the tray 1
Maximum size (custom)		215.9 x 356 mm (8.5 x 14 inches)		

a. If media weight is over 24 lb (90 g/m²), use the manual feed.

b. Maximum capacity may differ depending on media weight, thickness, and environmental conditions.



Note

For duplex printing, A4, Letter, Oficio, Legal, and Folio sizes are supported.

Guidelines for selecting and storing print media

When selecting or loading paper, envelopes, or other print media, keep these guidelines in mind:

- Always use print media that conform with the specifications listed on the next column.
- Attempting to print on damp, curled, wrinkled, or torn paper can cause paper jams and poor print quality.
- For the best print quality, use only high quality copier grade paper specifically recommended for use in laser printers.
- Avoid using the following print media types:
 - Paper with embossed lettering, perforations, or a texture that is too smooth or too rough
 - Erasable bond paper
 - Multi-paged paper
 - Synthetic paper and thermally reactive paper
 - Carbonless paper and Tracing paper.
- Use of these types of paper could result in paper jams, chemical smells, and damage to your printer.
- Store print media in its ream wrapper until you are ready to use it. Place cartons on pallets or shelves, not on the floor. Do not place heavy objects on top of the paper, whether it is packaged or unpackaged. Keep it away from moisture or other conditions that can cause it to wrinkle or curl.
- Store unused print media at temperatures between 15° C and 30° C (59° F to 86° F). The relative humidity should be between 10% and 70%.
- Store unused print media in a moisture-proof wrap, such as a plastic container or bag, to prevent dust and moisture from contaminating your paper.
- Load special print media types one sheet at a time through the manual tray to avoid paper jams.
- To prevent print media, such as transparencies and label sheets, from sticking together, remove them as they print out.



Caution

- If you print 20 envelopes in succession, the surface of the top cover may become hot. Please exercise caution.

Guidelines for special print media

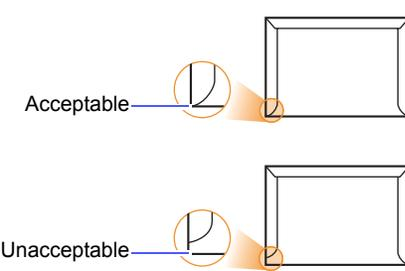
Type	Guidelines
Envelopes	<ul style="list-style-type: none">• Successful printing on envelopes depends upon the quality of the envelopes. When selecting envelopes, consider the following factors:<ul style="list-style-type: none">- Weight: The weight of the envelope paper should not exceed 90 g/m² (24 lb) or jamming may occur.- Construction: Prior to printing, envelopes should lie flat with less than 6 mm (0.25 inches) curl, and should not contain air.- Condition: Envelopes should not be wrinkled, nicked, or otherwise damaged.- Temperature: You should use envelopes that are compatible with the heat and pressure of the printer during operation.• Use only well-constructed envelopes with sharp and well creased folds.• Do not use stamped envelopes.• Do not use envelopes with clasps, snaps, windows, coated lining, self-adhesive seals, or other synthetic materials.• Do not use damaged or poorly made envelopes.• Be sure the seam at both ends of the envelope extends all the way to the corner of the envelope.  <ul style="list-style-type: none">• Envelopes with a peel-off adhesive strip or with more than one flap that folds over to seal must use adhesives compatible with the printer's fusing temperature for 0.1 second. Check your machine's specification to view the fusing temperature, see page 11.1. The extra flaps and strips might cause wrinkling, creasing, or jams, and may even damage the fuser.• For the best print quality, position margins no closer than 15 mm (0.6 inches) from the edges of the envelope.• Avoid printing over the area where the envelope's seams meet.

Type	Guidelines
Transparencies	<ul style="list-style-type: none"> To avoid damaging the printer, use only transparencies designed for use in laser printers. Transparencies used in the printer must be able to withstand the machine's fusing temperature. Check your machine's specification to view the fusing temperature, see page 11.1. Place them on a flat surface after removing them from the printer. Do not leave them in the paper tray for long periods of time. Dust and dirt may accumulate on them, resulting in spotty printing. To avoid smudging caused by fingerprints, handle them carefully. To avoid fading, do not expose printed transparencies to prolonged sunlight. Ensure that transparencies are not wrinkled, curled, or have any torn edges.
Labels	<ul style="list-style-type: none"> To avoid damaging the printer, use only labels designed for use in laser printers. When selecting labels, consider the following factors: <ul style="list-style-type: none"> - Adhesives: The adhesive material should be stable at 180° C (356° F), the printer's fusing temperature. - Arrangement: Only use labels with no exposed backing between them. Labels can peel off sheets that have spaces between the labels, causing serious jams. - Curl: Prior to printing, labels must lie flat with no more than 13 mm (5 inches) of curl in any direction. - Condition: Do not use labels with wrinkles, bubbles, or other indications of separation. Make sure that there is no exposed adhesive material between labels. Exposed areas can cause labels to peel off during printing, which can cause paper jams. Exposed adhesive can also cause damage to printer components. Do not run a sheet of labels through the printer more than once. The adhesive backing is designed for only a single pass through the printer. Do not use labels that are separating from the backing sheet or are wrinkled, bubbled, or otherwise damaged.
Card stock or custom-sized materials	<ul style="list-style-type: none"> Do not print on print media smaller than 76 mm (3 inches) wide or 127 mm (5 inches) long. In the software application, set margins at least 6.4 mm (0.25 inches) away from the edges of the material.

Type	Guidelines
Preprinted paper	<ul style="list-style-type: none"> Letterhead must be printed with heat-resistant ink that will not melt, vaporize, or release hazardous emissions when subjected to the printer's fusing temperature for 0.1 second. Check your machine's specification to view the fusing temperature, see page 11.1. Letterhead ink must be non-flammable and should not adversely affect printer rollers. Forms and letterhead should be sealed in a moisture-proof wrapping to prevent changes during storage. Before you load preprinted paper, such as forms and letterhead, verify that the ink on the paper is dry. During the fusing process, wet ink can come off preprinted paper, reducing print quality.

Loading paper

Load the print media you use for the majority of your print jobs in the tray 1. The tray 1 can hold a maximum of 250 sheets of 20 lb plain paper.

You can purchase an optional tray (tray 2) and attach it below the standard tray to load an additional 250 sheets of paper. For order information for an optional tray, see 7.1.

The paper level indicator on the front of the tray 1 and the optional tray 2 shows the amount of paper currently left in the tray. When the tray is empty, the indicator of the bar is completely lowered.

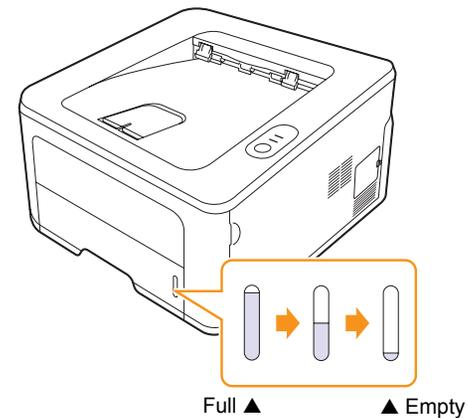

Using the tray 1 or the optional tray 2

Use the print material you use for the majority of your print jobs in the tray 1. The tray 1 can hold a maximum of 250 sheets of 75 g/m² paper.

You can purchase an optional tray 2 and attach it below the tray 1 to load an additional 250 sheets of paper.

To load paper, pull open the tray and load paper with the side to be printed on face down.

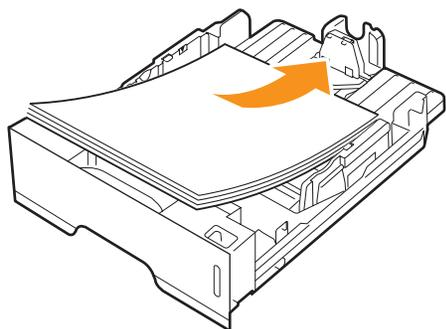

You can load letterhead paper with the design side face down. The top edge of the sheet with the logo should be placed at the front of the tray.



Notes

- If you experience problems with paper feed, place one sheet at a time in the manual feed.
- You can load previously printed paper. The printed side should be facing up with an uncurled edge at the front. If you experience problems with paper feed, turn the paper around. Note that the print quality is not guaranteed.

Changing the size of the paper in the tray 1

To load longer sizes of paper, such as Legal-sized paper, you need to adjust the paper guides to extend the paper tray.

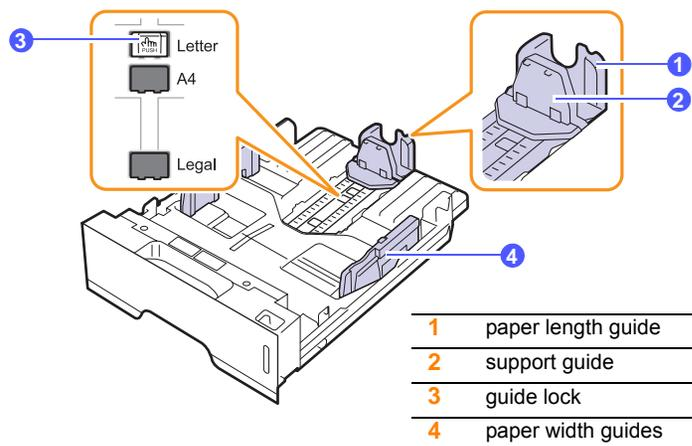

- 1 Press and hold the guide lock, and slide the paper length guide to locate it in the correct paper size slot.

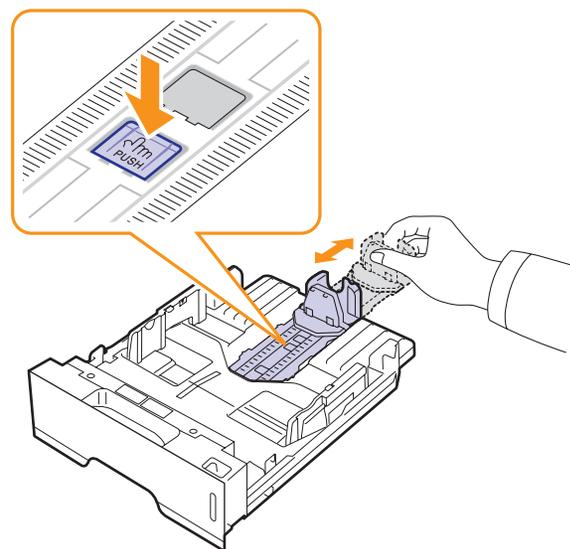

- 2 After inserting paper into the tray, adjust the support guide so that it lightly touches the paper stack.

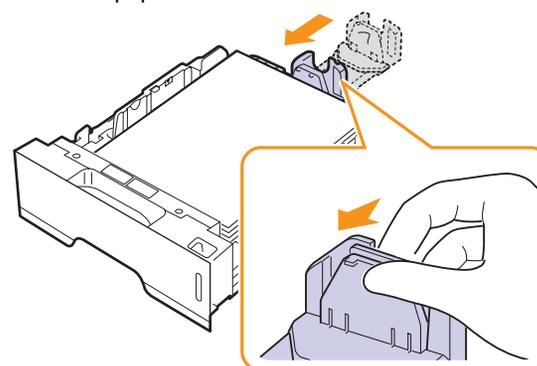

- 3 Squeeze the paper width guides, as shown and slide them to the stack of paper until it lightly touches the side of the stack.

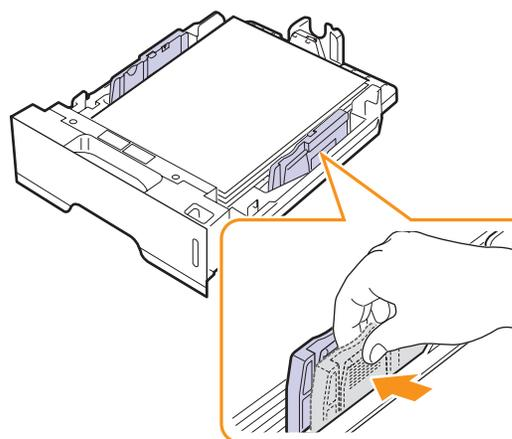



Notes

- Do not push the paper width guide far enough to cause the material to warp.
- If you do not adjust the paper width guide, it may cause paper jams.



Using manual feeder

You can manually load a sheet of print media in the manual tray if you select Manual Feeder in the Source option from the Paper tab when you change print settings to print a document. See the Software Section. Manually loading paper can be helpful when you want to check the print quality after each page is printed.

Load paper sheet-by-sheet in the manual tray, send print data to print the first page, and press the **Cancel** button on the control panel to print each following page.

- 1 Open the manual feed.

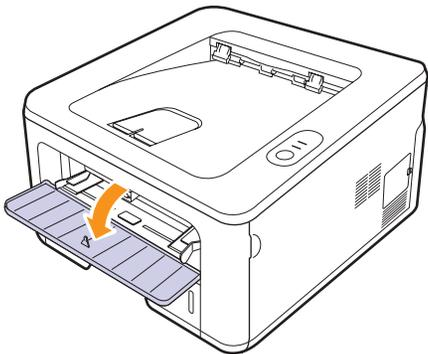

- 2 Load the paper **with the side to be printed on facing up**.

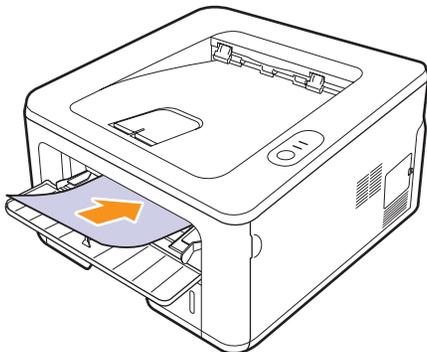

- 3 Adjust the manual tray paper width guides to the width of the paper. Do not force too much, or the paper will bend, which could result in a paper jam or skew.

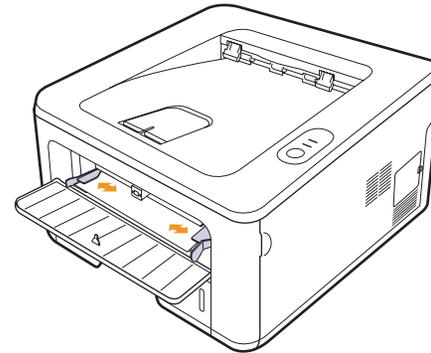

- 4 When you print a document, set the paper source to Manual Feeder and select the appropriate paper size and type in the software application. See the Software Section.
- 5 Print a document.
- 6 Press the **Cancel** button.
The printer picks up the print media and prints.



Note

- If you do not press the **Cancel** button, after a pause the printer will automatically pick the print media.

- 7 Insert the next sheet into the manual tray and press the **Cancel** button.
Repeat this step for every page to be printed.



Caution

- If envelopes or thick papers(163g/m²) are printed out with wrinkles, crease or black bold lines, open the rear cover and pull the guide of both sides down. Keep the rear cover opened during printing.

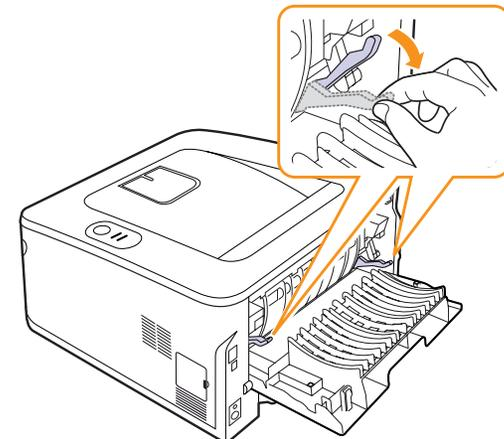

Printing with a prescribed paper size

Region	Country	mm
N.A.	US	101 x 152(4" x 6")
EU	UK	178 x 210
	Italy	152 x 197
	Austria	99 x 210
	Netherlands	148 x 105
	Swiss	-
	Hungary	100 x 203
	Poland	Min. 90 x 110
		Max. 200 x 215
	Slovakia	104 x 148
	Czech	107 x 147
Slovenia	Prescription (Receipt) 98 x 220	
	Doctors' note(napotnica) 154 x 210	
CIS	Russia	105 x 148.5
		125 x 176
S.E. Asia	Singapore	141 x 218
	Philippines	182 x 257



Caution

- Do not use print media that does not meet the media specifications in the user's guide, it can damage the machine. When using the media that meets the specification, set the paper to the right tray in the printer property.

Knowing an output location

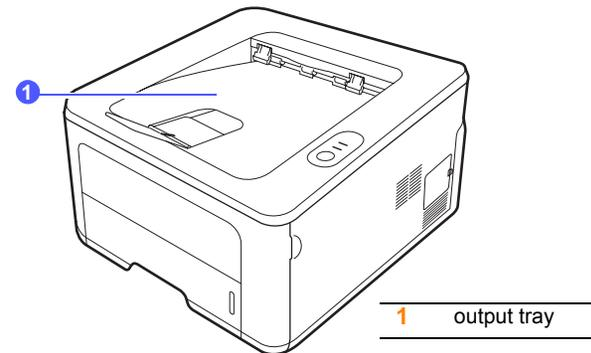

The output tray collects paper face down, in the order in which the sheets were printed.



Note

- If you continuously print many pages, the surface of the output tray may become hot. Be careful not to touch the surface, and especially keep children away from the surface.
- The output tray can hold up to 150 sheets of 75 g/m² (20 lb) plain paper. Remove the pages so that the tray is not overloaded.

5 Network setup(ML-2851ND only)

This chapter gives you basic information for setting up your printer for network connections.

This chapter includes:

- **Introduction**
- **Supported operating systems**
- **Using SetIP program**

Introduction

Once you have connected your printer to a network with an RJ-45 Ethernet cable, you can share the printer with other network users.

You need to set up the network protocols on the printer to use it as your network printer. Protocols can be set up by the following programs:

- **SyncThru™ Web Admin Service:** A web-based printer management solution for network administrators. **SyncThru™ Web Admin Service** provides you with an efficient way of managing network devices and lets you remotely monitor and troubleshoot network printers from any site with corporate intranet access. You can download this program from <http://solution.samsungprinter.com>.
- **SyncThru™ Web Service:** A web server embedded to your network print server, which allows you to configure the network parameters necessary for the printer to connect to various network environments.
- **SetIP:** A utility program allowing you to select a network interface and manually configure the addresses for use with the TCP/IP protocol. This program is on the software CD that comes with your printer.

Supported operating systems

The following table shows the network environments supported by the printer:

Item	Requirements
Network interface	<ul style="list-style-type: none">• 10/100 Base-TX
Network operating system	<ul style="list-style-type: none">• Windows 2000/XP/2003/2008/Vista/7/ Server 2008 R2• Varios Linux OS including Red Hat 8 ~ 9, Fedora Core 1 ~ 4, Mandrake 9.2 ~ 10.1, SuSE 8.2 ~ 9.2• Mac OS 8.6 ~ 9.2, 10.1 ~ 10.6
Network protocols	<ul style="list-style-type: none">• TCP/IP• EtherTalk• HTTP 1.1• SNMP

Item	Requirements
Dynamic addressing server	<ul style="list-style-type: none">• DHCP, BOOTP

- TCP/IP: Transmission Control Protocol/Internet Protocol
- DHCP: Dynamic Host Configuration Protocol
- BOOTP: Bootstrap Protocol

Using SetIP program

This program is for the network IP setting using the MAC address which is the hardware serial number of the network printer card or interface. Especially, it is for the network administrator to set several network IPs at the same time.



Note

If you want to setup DHCP network protocol, go to the <http://developer.apple.com/networking/bonjour/download/>, select the program Bonjour for Windows due to your computer operating system, and install the program. This program will allow you to fix the network parameter automatically. Follow the instruction in the installation window. This program does not support Linux.

- 1 Insert the driver CD provided along with your machine.
- 2 Start Windows Explorer and open the X drive. (X represents your CD-ROM drive.)
- 3 Double click **Application > SetIP**
- 4 Open the language folder you want to use.
- 5 Double click **Setup.exe** to install this program.
- 6 From the Windows Start menu, select **Programs > Samsung Network Printer Utilities > SetIP**.
- 7 Select the name of your printer and click “”.



Note

If you cannot find your printer name click “” to refresh the list.

- 8 Enter the network card's MAC address, IP address, subnet mask, default gateway, and then click **Apply**.
-  **Note**
If you do not know the network card's MAC address, print the machine's network information report.
- 9 Click **OK** to confirm the settings.
 - 10 Click **Exit** to close the SetIP program.

6 Basic printing

This chapter explains common printing tasks.

This chapter includes:

- **Printing a document**
- **Canceling a print job**

Printing a document

This printer allows you to print from various Windows, Macintosh, or Linux applications. The exact steps for printing a document may vary depending on the application you use.

For details about printing, see the Software Section.

Canceling a print job

If the print job is waiting in a print queue or print spooler, such as the printer group in Windows, delete the job as follows:

- 1 Click the Windows **Start** button.
- 2 For Windows 2000, select **Settings** and then **Printers**.
For Windows XP/2003, select **Printers and Faxes**.
For Windows Vista/2008, select **Control Panel > Hardware and Sound > Printers**.
For Windows 7, select **Control Panel > Hardware and Sound > Devices and Printers**.
For Windows Server 2008 R2, select **Control Panel > Hardware > Devices and Printers**.
- 3 For Windows 2000, XP, 2003, 2008 and Vista, double-click your machine.
For Windows 7 and Windows Server 2008 R2, right click your printer icon > context menus > **See what's printing**.
- 4 From the **Document** menu, select **Cancel**.



Note

- You can access this window simply by double-clicking the printer icon at the bottom right corner of the Windows desktop.

You can also cancel the current job by pressing the **Cancel** button on the control panel of your printer.

7 Ordering supplies and accessories

This chapter provides information on the toner cartridge and accessory that are available for your printer.

This chapter includes:

- **Toner cartridge**
- **Accessory**
- **How to purchase**

Toner cartridge

When the toner runs out, you can order the following type of toner cartridge for your printer:

Type	Yield ^a	Part number
Standard yield	Approx.2,000 pages	ML-D2850A
High yield	Approx.5,000 pages	ML-D2850B

a. Declared yield value in accordance with ISO/IEC 19752.



Caution

When you purchase a new print cartridge or supplies, you must purchase them in the same country you have purchased your machine. Otherwise, the print cartridge or supplies will be incompatible with your machine since the configuration of the print cartridge or supplies vary depending on the countries.

Accessory

You can purchase and install the following accessory to your ML-2850D and ML-2851ND printer:

Accessory	Description	Part number
Optional Tray	If you are experiencing frequent paper supply problems, you can attach additional 250 sheet trays. You can print documents on various sizes and types of print media.	ML-S2850A
Memory DIMM	Extends your printer's memory capacity.	• CLP-MEM301: 128 MB

How to purchase

To order Samsung-authorized supplies or accessories, contact your local Samsung dealer or the retailer where you purchased your printer, or visit www.samsungprinter.com and select your country/region for information on calling for technical support.

8 Maintenance

This chapter provides information for maintaining your printer and the toner cartridge.

This chapter includes:

- **Cleaning the printer**
- **Maintaining the toner cartridge**
- **Printing a configuration page**
- **Maintenance parts**

Cleaning the printer

During the printing process, paper, toner, and dust particles can accumulate inside the printer. This buildup can cause print quality problems, such as toner specks or smearing.

- Caution**
- Cleaning the cabinet of the printer with cleaning materials containing large amounts of alcohol, solvents, or other strong substances can discolor or crack the cabinet.
 - If your machine or its around is contaminated with toner, we recommend you to use cloth or tissue dampened with water to clean it. If you use a vacuum cleaner, toner blows in the air and might be harmful for you.

Cleaning the outside of the printer

Clean the cabinet of the printer with a soft, lint-free cloth. You can dampen the cloth slightly with water, but be careful not to let any water drip onto or into the printer.

Cleaning the inside of the printer

- 1 Turn the printer off and unplug the power cord. Wait for the printer to cool down.
- 2 Open the front cover and pull the toner cartridge out. Set it on a clean flat surface.

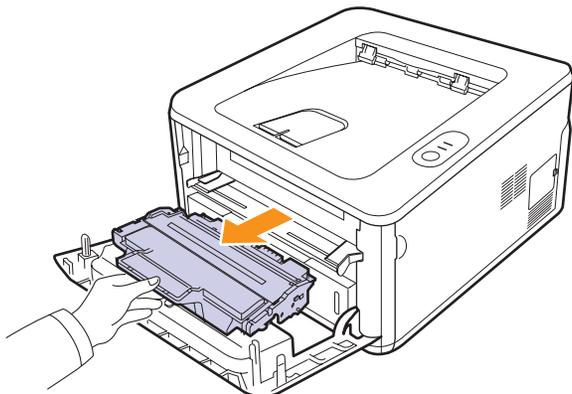

- Caution**
- To prevent damage to the toner cartridge, do not expose it to light for more than a few minutes. Cover it with a piece of paper, if necessary.
 - Do not touch the green surface underside of the toner cartridge. Use the handle on the cartridge to avoid touching this area.
- 3 With a dry lint-free cloth, wipe away any dust and spilled toner from the toner cartridge area and the toner cartridge cavity.

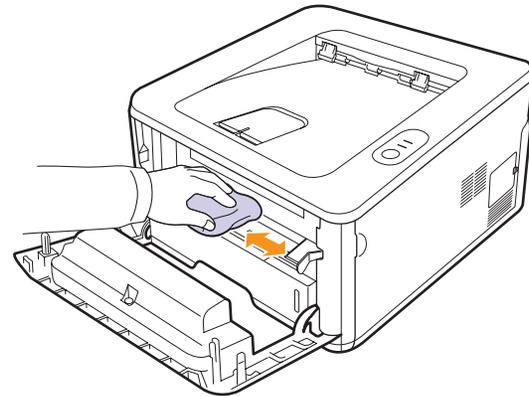

- Caution**
- While cleaning the inside of the printer, be careful not to reach too far into the printer. The fuser area may be hot.
- 4 Gently swab the long strip of glass (LSU) inside the top of the cartridge and check for dirt or dust.

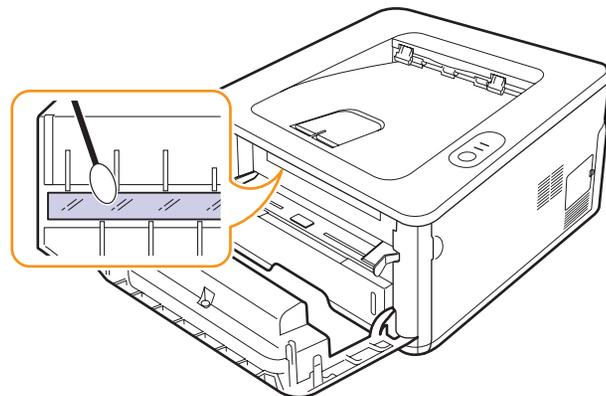

- Note**
- The long strip of glass is hard to locate.
- 5 Hold the toner cartridge by the handle and slowly insert the cartridge into the opening in the printer.

Tabs on the sides of the cartridge and corresponding grooves within the printer will guide the cartridge into the correct position until it locks into place completely.

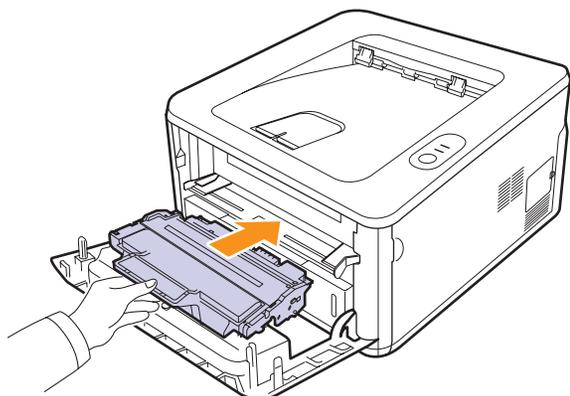

- 6 Close the front cover. Make sure that the cover is securely closed.
- 7 Plug in the power cord and turn the printer on.

Maintaining the toner cartridge

Toner cartridge storage

Toner cartridges contain components that are sensitive to light, temperature, and humidity. Samsung suggests users follow the recommendations to ensure the optimum performance, highest quality, and longest life from your new Samsung toner cartridge.

Store this cartridge in the same environment as the printer it will be used in; this should be in controlled office temperature and humidity conditions. The toner cartridge should remain in its original, unopened package until installation – If original packaging is not available, cover the top opening of the cartridge with paper and store in a dark cabinet.

Opening the cartridge package prior to use dramatically shortens its useful shelf and operating life. Do not store on the floor. If the toner cartridge is removed from the printer, always store the cartridge:

- Inside the protective bag from the original package
- Correct side up in a horizontal position (not standing on end)
- Do not store consumables in;
 - Temperature greater than 40°C (104°F).
 - Humidity range less than 20% and not greater than 80%.
 - An environment with extreme changes in humidity or temperature.
 - Direct sunlight or room light.
 - Dusty places.
 - A car for a long period of time.
 - An environment where corrosive gases are present.
 - An environment with salty air.

Handling instructions

- Do not touch the surface of the photosensitive drum in the cartridge.
- Do not expose the cartridge to unnecessary vibrations or shock.
- Never manually rotate the drum, especially in the reverse direction; this can cause internal damage and toner spillage.

Use of non-Samsung and refilled toner cartridge

Samsung Electronics does not recommend or approve the use of non-Samsung brand toner cartridges in your printer including generic, store brand, refilled, or remanufactured toner cartridges.



Caution

- Samsung's printer warranty does not cover damage to the machine caused by the use of a refilled, remanufactured, or non-Samsung brand toner cartridge.

Estimated cartridge life

Estimated cartridge life (the life of the toner cartridge yield) depends on the amount of toner that print jobs require. The actual print-out number may vary depending on the print density of the pages you print on, operating environment, printing interval, media type, and/or media size. For example, if you print a lot of graphics, the consumption of the toner is high and you may need to change the cartridge more often.



Caution

- Samsung does not recommend using non-genuine Samsung toner cartridge such as refilled or remanufactured. Samsung cannot guarantee non-genuine Samsung toner cartridge's quality. Service or repair required as a result of using non-genuine Samsung toner cartridges will not be covered under the machine warranty.

Redistributing toner cartridge

Small amount of toner is left in the cartridge. The estimated cartridge life of toner is close.:

- White streaks and light printing occur.
- The Smart Panel program window appears on the computer.
- The **Error** LED blinks red.

Prepare a new cartridge for replacement. You may temporarily increase the printing quality by redistributing the toner.

- 1 Open the front cover.
- 2 Pull the toner cartridge out.

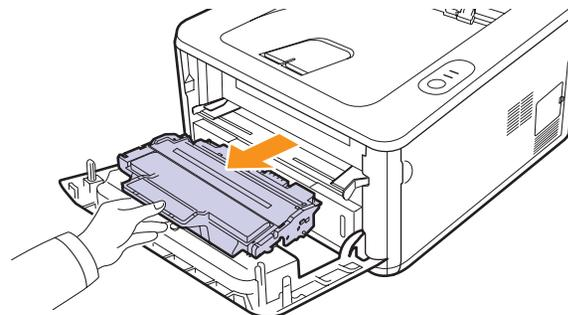



Caution

- Avoid reaching too far into the printer. The fuser area may be hot.
- To prevent damage to the toner cartridge, do not expose it to light for more than a few minutes. Cover it with a piece of paper, if necessary.
- Do not touch the green surface underside of the toner cartridge. Use the handle on the cartridge to avoid touching this area.

- 3 Thoroughly shake the cartridge 5 or 6 times to distribute the toner evenly inside the cartridge.

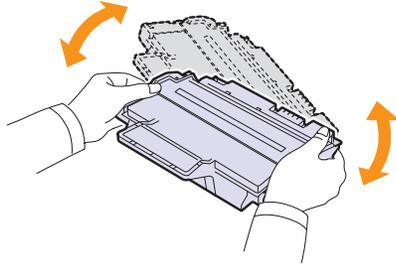

Caution

- If toner gets on your clothing, wipe it off with a dry cloth and wash clothing in cold water. Hot water sets toner into fabric.

- 4 Hold the toner cartridge by the handle and slowly insert the cartridge into the opening in the printer.

Tabs on the sides of the cartridge and corresponding grooves within the printer will guide the cartridge into the correct position until it locks into place completely.

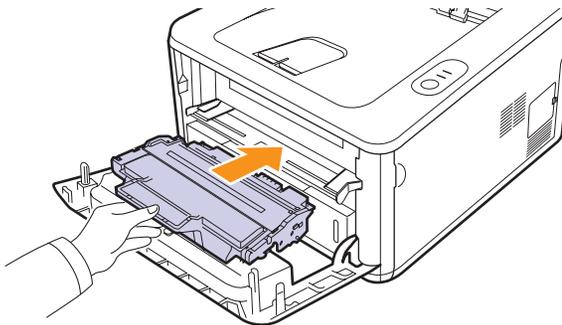

- 5 Close the front cover. Make sure that the cover is securely closed.



Note

- At this stage, if you need to replace the toner cartridge, see page 8.4.

Replacing the toner cartridge

A toner cartridge has reached its estimated cartridge life.:

- The printer stops printing.
- The Smart Panel program window appears on the computer.
- The **Error** LED blinks red.



Note

- Estimated cartridge life means the expected or estimated toner cartridge life, which indicates the average capacity of print-outs and is designed pursuant to ISO/IEC 19752. (See Specification on page 11.1.) The number of pages may be affected by operating environment, printing interval, media type, and media size. Some amount of toner may remain in the cartridge even when the error LED blinks red, and the printer stops printing.

At this stage, the toner cartridge needs to be replaced. For toner cartridge ordering information, see page 7.1.

- 1 Open the front cover.
- 2 Pull the old toner cartridge out.

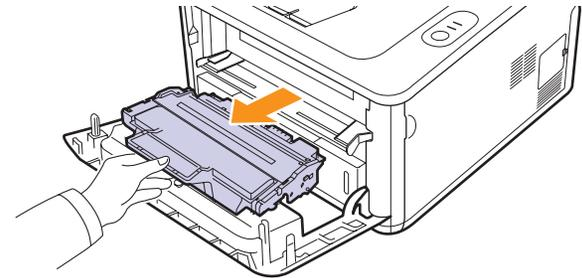

- 3 Remove the new toner cartridge from its bag.



Caution

- Do not use sharp objects, such as a knife or scissors, to open the toner cartridge package. They might scratch the drum of the cartridge.

- 4 Thoroughly shake the cartridge 5 or 6 times to distribute the toner evenly inside the cartridge.

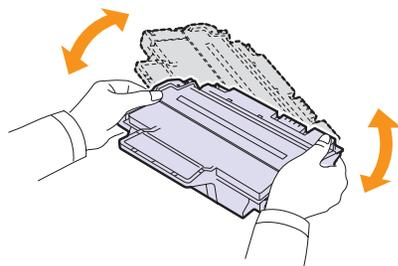

Thoroughly shake the cartridge to assure maximum copies per cartridge.

- 5 Remove the paper protecting the toner cartridge by pulling the packing tape.

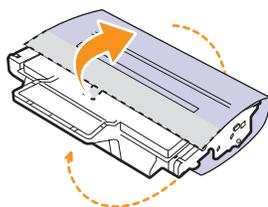

Note

- Refer to the helpful pictures on the cartridge wrapping paper.



Caution

- If toner gets on your clothing, wipe it off with a dry cloth and wash clothing in cold water. Hot water sets toner into fabric.
- To prevent damage to the toner cartridge, do not expose it to light for more than a few minutes. Cover it with a piece of paper, if necessary.
- Do not touch the green surface underside of the toner cartridge. Use the handle on the cartridge to avoid touching this area.

- 6 Hold the toner cartridge by the handle and slowly insert the cartridge into the opening in the printer.

Tabs on the sides of the cartridge and corresponding grooves within the printer will guide the cartridge into the correct position until it locks into place completely.

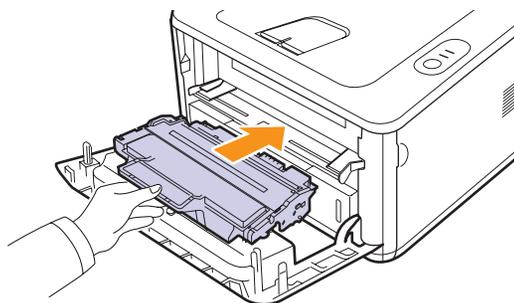

- 7 Close the front cover. Make sure that the cover is securely closed.

Printing a configuration page

You can print a configuration page to view current printer settings, or to help troubleshoot printer problems.

Press and hold the **Cancel** button for about 5 seconds.

A configuration page prints out.

Maintenance parts

To avoid print quality and paper feed problems resulting from worn parts and to maintain your machine in top working condition the following items will need to be replaced at the specified number of pages or when the life span of each item has expired.

Items	Yield (Average)
Transfer roller	Approx. 50,000 pages
Fuser unit	Approx. 50,000 pages
Pick-up roller	Approx. 50,000 pages

Samsung highly recommends that an authorized service provider, dealer or the retailer where you bought printer performs this maintenance activity.

The warranty does not cover the replacement of the maintenance parts after their lifespan.

The warranty does not cover the replacement of the maintenance parts after their lifespan.

9 Troubleshooting

This chapter provides helpful information for what to do if you encounter an error while using your printer.

This chapter includes:

- **Clearing paper jams**
- **Troubleshooting checklist**
- **Solving general printing problems**
- **Solving print quality problems**
- **Common Windows problems**
- **Common PostScript problems**
- **Common Linux problems**
- **Common Macintosh problems**

Clearing paper jams



Note

- When removing paper that is jammed in the printer, if possible always pull the paper in the direction that it normally moves so as not to damage internal components. Always pull firmly and evenly; do not jerk the paper. If the paper tears, ensure that all fragments of paper are removed; otherwise a jam will occur again.

When a paper jam occurs, the **Error** LED lights orange. Open and close the front cover. The jammed paper automatically exits the printer.

In the paper feed area

In the tray 1

- 1 Pull the tray 1 open.

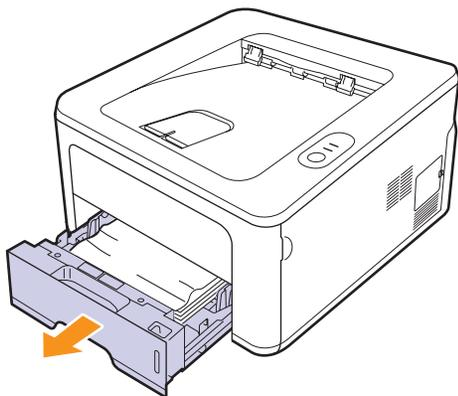

- 2 Remove the jammed paper by gently pulling it straight out. Make sure that all of the paper is properly aligned in the tray 1.

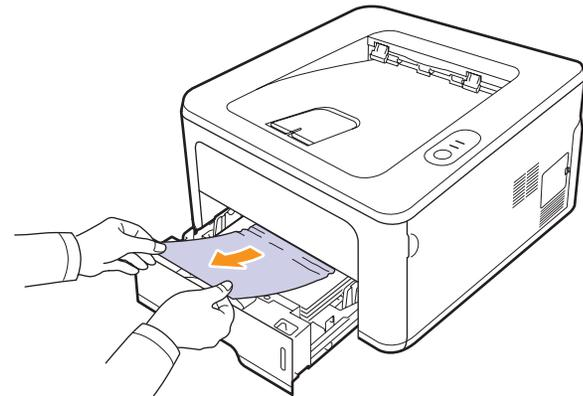

If the paper does not move when you pull, or if you do not see the paper in this area, check the fuser area around the **toner cartridge**. See page 9.2.

- 3 Insert the tray 1 into the printer until it snaps into place. Printing automatically resumes.

In the optional tray 2

- 1 Pull the optional tray 2 open.
- 2 Remove the jammed paper from the printer.

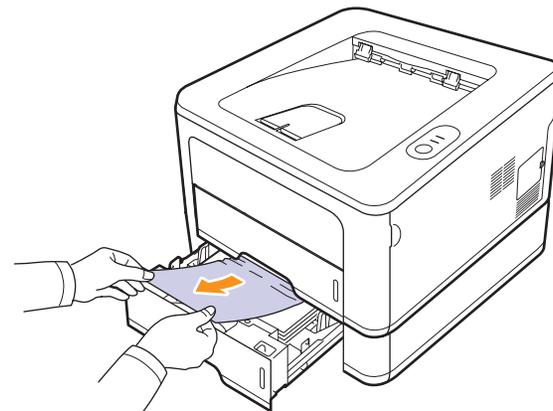

If the paper does not move when you pull, or if you do not see the paper in this area, stop and go to step 3.

- 3 Pull the tray 1 half.

- 4 Pull the paper straight up and out.

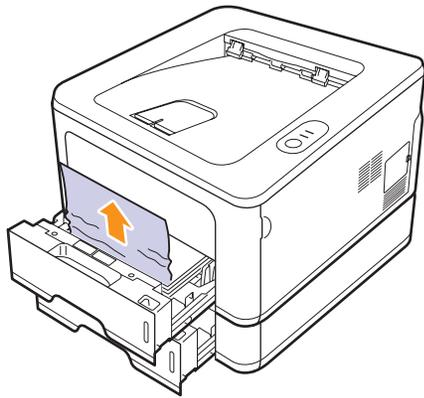

- 5 Insert the trays back into the printer. Printing automatically resumes.

In the manual tray

- 1 Remove the jammed paper from the printer.

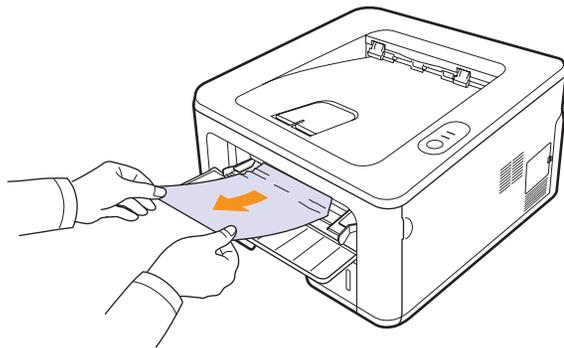

- 2 Open and close the front cover.
- 3 Load a paper into the manual feeder, then the printer resumes.

Around the toner cartridge



Note

The fuser area is hot. Take care when removing paper from the printer.

- 1 Open the front cover and pull the **toner cartridge** out.

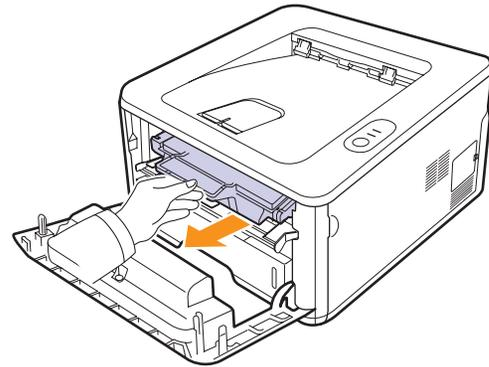

- 2 Remove the jammed paper by gently pulling it straight out.

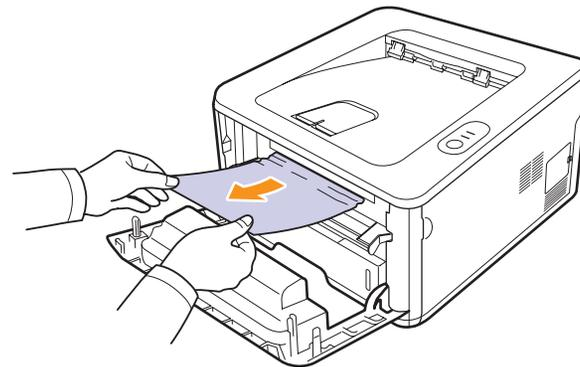

- 3 Replace the toner cartridge and close the front cover. Printing automatically resumes.

In the paper exit area

- 1 Open and close the front cover. The jammed paper is automatically ejected from the printer.
- 2 Gently pull the paper out of the output tray.

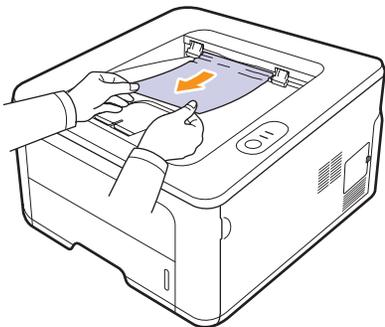

If you do not see the jammed paper or if there is any resistance when you pull, stop and go to the next step.

- 3 Open the rear cover.
- 4 Pull the guide rear on each side down and remove the paper. Return the guide rear to its original position.

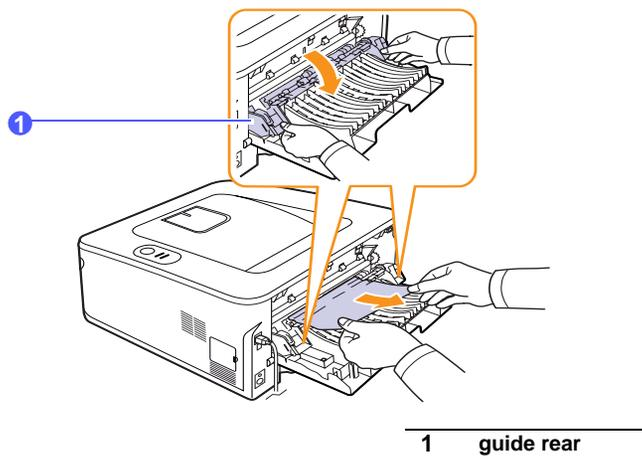

- 5 Close the rear cover. Printing automatically resumes.

In the duplex unit area

If the duplex unit is not inserted correctly, paper jam may occur. Make sure that the duplex unit is inserted correctly.

Duplex jam 0

- 1 Pull the duplex unit out of the printer.

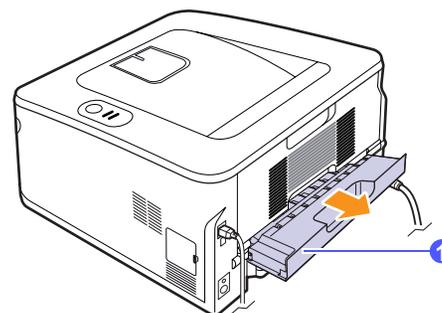

- 2 Remove the jammed paper from the duplex unit.

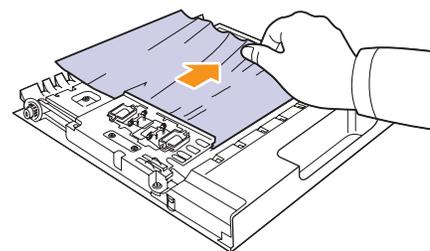

If the paper does not come out with the duplex unit, remove the paper from the bottom of the printer.

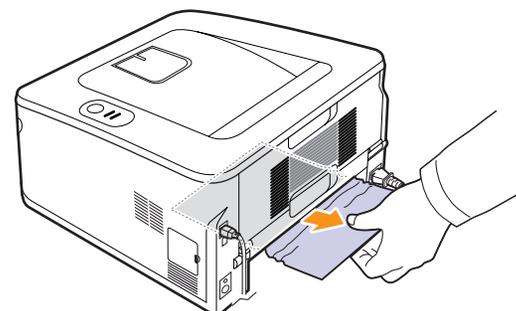

Duplex jam 1

- 1 Open the rear cover.
- 2 Pull the guide rear on each side down and remove the paper. Return the guide rear to its original position.

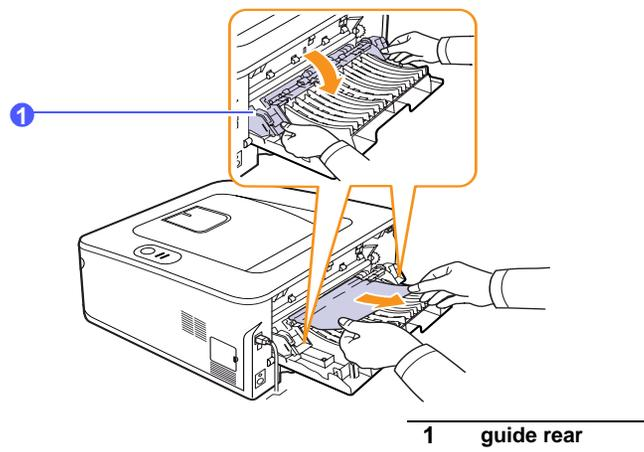

- 3 Close the rear cover. Printing automatically resumes.

Tips for avoiding paper jams

By selecting the correct media types, most paper jams can be avoided. When a paper jam occurs, follow the steps outlined on 9.1.

- Follow the procedures on 4.5. Ensure that the adjustable guides are positioned correctly.
- Do not overload the tray. Ensure that the paper level is below the paper capacity mark on the inside wall of the tray.
- Do not remove paper from the tray while your printer is printing.
- Flex, fan, and straighten paper before loading.
- Do not use creased, damp, or highly curled paper.
- Do not mix paper types in a tray.
- Use only recommended print media. See 4.1.
- Ensure that the recommended print side of print media is facing down in the tray, or facing up in the manual tray.
- If paper jams occur frequently when you print on A5-sized paper:

Load the paper into the tray with the long edge facing the front of the tray.

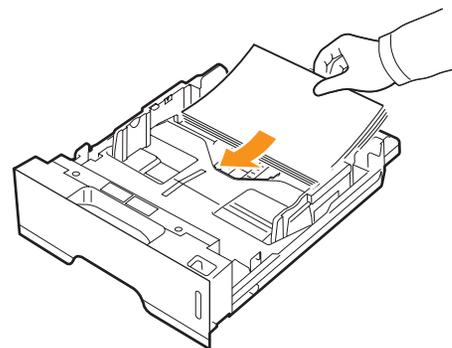

In the printer properties window, set the page orientation to be rotated 90 degrees. See the Software Section.

Troubleshooting checklist

If the printer is not working properly, consult the following checklist. If the printer does not pass a step, follow the corresponding suggested solutions.

Condition	Suggested solutions
Make sure that the Online LED on the control panel lights green.	<ul style="list-style-type: none"> If the Online LED is off, check the power cord connection. Check the power switch. Check the power source by plugging the power cord into another outlet.
Print a demo page to verify that the printer is feeding paper correctly. See page 2.1.	<ul style="list-style-type: none"> If a demo page does not print, check the paper supply in the tray. If the paper jams in the printer, see page 9.1.
Check the demo page to see if it printed correctly.	If there is a print quality problem, see page 9.7.
Print a short document from a software application to verify that the computer and printer are connected and are communicating correctly.	<ul style="list-style-type: none"> If the page does not print, check the cable connection between the printer and the computer. Check the print queue or print spooler to see if the printer has been paused. Check the software application to ensure that you are using the proper printer driver and communication port. If the page is interrupted during printing, see page 9.5.
If completing the checklist does not resolve the printer problem, check the following troubleshooting sections.	<ul style="list-style-type: none"> “Understanding the LEDs” on page 1.3. “Solving general printing problems” on page 9.5. “Common Windows problems” on page 9.9. “Common PostScript problems” on page 9.10. “Common Linux problems” on page 9.10. “Common Macintosh problems” on page 9.11.

Solving general printing problems

For problems with the operation of your printer, refer to the table for suggested solutions.

Condition	Possible cause	Suggested solutions
The printer does not print.	The printer is not receiving power.	Check the power cord connections. Check the power switch and the power source.
	The printer is not selected as the default printer.	Select Samsung ML-2850 Series or Samsung ML-2850 Series PS as your default printer.
	The printer cover is not closed.	Close the printer cover.
	Paper is jammed.	Clear the paper jam. See page 9.1.
	No paper is loaded.	Load paper. See page 4.4.
	The toner cartridge is not installed.	Install the toner cartridge.
	The printer may be in manual feed mode and out of paper.	Add paper to the manual tray, and press the Cancel button on the control panel.
	The connection cable between the computer and the printer is not connected properly.	Disconnect the printer cable and reconnect it.
	The connection cable between the computer and the printer is defective.	If possible, attach the cable to another computer that is working properly and try to print a document. You can also try using a different printer cable.
	The port setting is incorrect.	Check the Windows printer setting to make sure that the print job is sent to the correct port. If the computer has more than one port, make sure that the printer is attached to the correct one.

Condition	Possible cause	Suggested solutions
The printer does not print. (Continued)	The printer may be configured incorrectly.	Check the printer properties to ensure that all of the print settings are correct.
	The printer driver may be incorrectly installed.	Reinstall the printer driver; See the Software Section. Try printing a test page.
	The printer is malfunctioning.	Check the LEDs on the control panel to determine if the printer is indicating a system error.
Printer selects print media from the wrong paper source.	The paper source selection in the printer properties may be incorrect.	For many software applications, the paper source selection is found under the Paper tab within the printer properties. Select the correct paper source. See the Software Section.
Paper does not feed into the printer.	Paper has not been loaded correctly.	Remove paper from the tray and reload it correctly. Check that the adjustable guides are set correctly.
	There is too much paper in the tray.	Remove excess paper from the tray.
	The paper is too thick.	Use only paper that meets printer specifications.
Print job is extremely slow.	The job may be very complex.	Reduce the complexity of the page(s) or try adjusting the print quality settings. To adjust the print quality settings, reduce the resolution. If you have set the resolution to 1200 dpi (Best) , change it to 600 dpi (Normal) . See the Software Section. Change the port setting to the USB or network port to improve print speed. Your printer prints A4-sized paper at 28 ppm and letter-sized paper at 30 ppm.
Print job is extremely slow. (Continued)	The computer may have insufficient random-access memory (RAM).	Simplify the page layout and remove any unnecessary graphics from the document.

Condition	Possible cause	Suggested solutions
Half the page is blank.	The page layout is too complex.	Simplify the page layout and remove any unnecessary graphics from the document.
	The page orientation setting may be incorrect.	Change the page orientation in your application. See the Software Section.
	The paper size and the paper size settings do not match.	Ensure that the paper size in the printer driver settings matches the paper in the tray. Or, ensure that the paper size in the printer driver settings matches the paper selection in the software application settings you use.
The paper keeps jamming.	There is too much paper in the tray.	Remove excess paper from the tray. If printing on special print media, use the manual tray.
	An incorrect type of paper is being used.	Use only paper that meets printer specifications. If printing on special print media, use the manual tray.
	There may be debris inside the printer.	Open the front cover and remove the debris.
The printer prints, but the text is wrong, garbled, or incomplete.	The printer cable is loose or defective.	Disconnect and reconnect the printer cable. Try a print job that you have already printed successfully. If possible, attach the cable and printer to another computer and try a print job that you know works. Finally, try a new printer cable.
	The wrong printer driver was selected.	Check the application's printer selection menu to ensure that your printer is selected.
	The software application is malfunctioning.	Try printing a job from another application.
	If you are under the DOS environment, the font setting for your machine may be set incorrectly.	Change the font setting. See page 1.6.

Condition	Possible cause	Suggested solutions
Pages print, but are blank.	The toner cartridge is defective or out of toner.	Redistribute the toner cartridge. See page 8.2. If necessary, replace the toner cartridge. See page 8.3.
	The file may have blank pages.	Check the file to ensure that it does not contain blank pages.
	Some parts, such as the controller or the board, may be defective.	Contact a service representative.
The illustrations print incorrectly in Adobe Illustrator.	The setting in the software application is wrong.	Select Download as Bitmap in the Advanced Options window of the graphic properties. Print the document again.
The printer does not print PDF file correctly. Some parts of graphics, text, or illustrations are missing.	Incompatibility between the PDF file and the Acrobat products	Printing the PDF file as an image may solve this problem. Turn on Print As Image from the Acrobat printing options. Note: It will take longer to print when you print a PDF file as an image.

Solving print quality problems

Dirt inside of the printer or improper paper loading may reduce print quality. See the table below to troubleshoot problems.

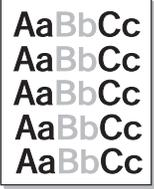
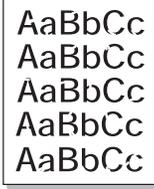
Condition	Suggested solutions
Light or faded print 	<p>If a vertical white streak or faded area appears on the page:</p> <ul style="list-style-type: none"> The toner supply is low. You may be able to temporarily extend the toner cartridge life. See page 8.2. If this does not improve print quality, install a new toner cartridge. The paper may not meet paper specifications (for example, the paper is too moist or too rough). See page 4.3. If the entire page is light, the print resolution setting is too light or toner save mode is on. Adjust the print resolution and toner save mode in the printer properties. See the Software Section. A combination of faded or smeared defects may indicate that the printer needs cleaning. See page 8.1. The surface of LSU may be dirty. Clean the LSU. See page 8.1.
Toner spots 	<ul style="list-style-type: none"> The paper may not meet specifications (for example, the paper is too moist or too rough). See page 4.3. The transfer roller or paper path may be dirty. See page 8.1.
Dropouts 	<p>If generally rounded, faded areas occur randomly on the page:</p> <ul style="list-style-type: none"> A single sheet of paper may be defective. Try reprinting the job. The moisture content of the paper is uneven or the paper has moist spots on its surface. Try a different brand of paper. See page 4.3. The paper lot is bad. The manufacturing processes can cause some areas to reject toner. Try a different kind or brand of paper. The toner cartridge may be defective. See "Vertical repetitive defects" on the next column. If these steps do not correct the problems, contact a service representative.

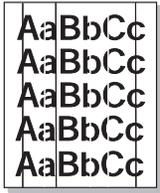
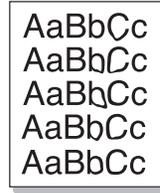
Condition	Suggested solutions
Vertical lines 	<p>If black vertical streaks appear on the page:</p> <ul style="list-style-type: none"> The drum inside the toner cartridge has probably been scratched. Install a new toner cartridge. See page 8.3. <p>If white vertical streaks appear on the page:</p> <ul style="list-style-type: none"> The surface of the LSU part inside the printer may be dirty. Clean the LSU. See page 8.1.
Gray background 	<p>If the amount of background shading becomes unacceptable, the procedures below may fix the problem.</p> <ul style="list-style-type: none"> Change to lighter weight pages. See page 4.3. Check the printer's environment; low humidity (lower than 20% RH) or high humidity (higher than 80% RH) conditions can increase the amount of background shading. Remove the old toner cartridge and install a new one. See page 8.3.
Toner smear 	<ul style="list-style-type: none"> Clean the inside of the printer. See page 8.1. Check the paper type and quality. See page 4.2. Remove the toner cartridge and install a new one. See page 8.3.
Vertical repetitive defects 	<p>If marks repeatedly appear on the printed side of the page at even intervals:</p> <ul style="list-style-type: none"> The toner cartridge may be damaged. If a repetitive mark occurs on the page, install a new toner cartridge. See page 8.3. Parts of the printer may have toner on them. If the defects occur on the back of the page, the problem will likely correct itself after a few more pages. The fusing assembly may be damaged. Contact a service representative.

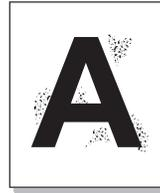
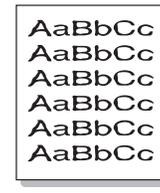
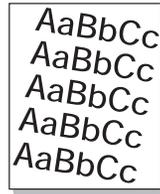
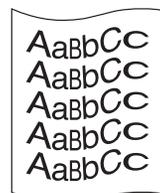
Condition	Suggested solutions
Background scatter 	<p>Background scatter results from bits of toner distributed on the printed page.</p> <ul style="list-style-type: none"> The paper may be too damp. Try printing with a different batch of paper. Do not open packages of paper until necessary so that the paper does not absorb too much moisture. If background scatter occurs on an envelope, change the printing layout to avoid printing over areas that have overlapping seams on the reverse side. Printing on seams can cause problems. If background scatter covers the entire surface area of a printed page, adjust the print resolution through your software application or via the printer properties window.
Misformed characters 	<ul style="list-style-type: none"> If characters are improperly formed and producing hollowed images, the paper stock may be too slick. Try a different paper. See page 4.3.
Page skew 	<ul style="list-style-type: none"> Ensure that the paper is loaded properly. Check the paper type and quality. See page 4.2. Ensure that the paper is loaded correctly and the adjustable guides are not too tight or too loose against the paper stack.
Curl or wave 	<ul style="list-style-type: none"> Ensure that the paper is loaded properly. Check the paper type and quality. Both high temperature and humidity can cause paper curl. See page 4.2. Turn over the stack of paper in the tray. Also try rotating the paper 180° in the tray.

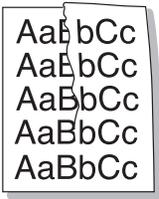
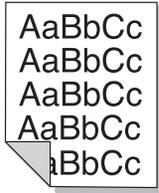
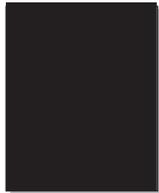
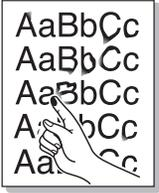
Condition	Suggested solutions
Wrinkles or creases 	<ul style="list-style-type: none"> • Ensure that the paper is loaded properly. • Check the paper type and quality. See page 4.2. • Turn over the stack of paper in the tray. Also try rotating the paper 180° in the tray.
Back of printouts are dirty 	<ul style="list-style-type: none"> • The transfer roller may be dirty. See page 8.1. • Check for leaking toner. Clean the inside of the printer.
Solid black pages 	<ul style="list-style-type: none"> • The toner cartridge may not be installed properly. Remove the cartridge and reinsert. • The toner cartridge may be defective and need replacing. Install a new toner cartridge. • The printer may require repair. Contact a service representative.
Loose toner 	<ul style="list-style-type: none"> • Clean the inside of the printer. • Check the paper type and quality. See page 4.2. • Install a new toner cartridge. See page 8.3. • If the problem persists, the printer may require repair. Contact a service representative.
Character voids 	<p>Character voids are white areas within characters that should be solid black:</p> <ul style="list-style-type: none"> • If you are using transparencies, try another type of transparency. Because of the composition of the transparency, some character voids may be normal. • You may be printing on the wrong surface on the paper. Turn over the paper in the tray. • The paper may not meet paper specifications. See page 4.3.

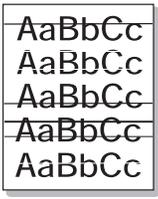
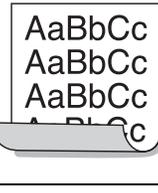
Condition	Suggested solutions
Horizontal stripes 	<p>If horizontally aligned black streaks or smears appear:</p> <ul style="list-style-type: none"> • The toner cartridge may be installed improperly. Remove the cartridge and reinsert. • The toner cartridge may be defective. Install a new toner cartridge. See page 8.3. • If the problem persists, the printer may require repair. Contact a service representative.
Curl 	<p>If the printed paper is curled or paper does not feed into the printer:</p> <ul style="list-style-type: none"> • Turn over the stack of paper in the tray. Also try rotating the paper 180° in the tray.
<p>An unknown image repetitively appears on a next few sheets or loose toner, light print or contamination occurs.</p>	<p>Your printer is probably being used at an altitude of 1,000 m (3,281 ft) or above.</p> <p>The high altitude may affect the print quality such as loose toner or light imaging. You can set this option through Printer Settings Utility or Printer tab in printer driver's properties. See page 1.5.</p>

Common Windows problems

Condition	Suggested solutions
<p>"File in Use" message appears during installation.</p>	<p>Exit all software applications. Remove all software from the StartUp Group, then restart Windows. Reinstall the printer driver.</p>
<p>"Error Writing to LPTx" message appears.</p>	<ul style="list-style-type: none"> • Ensure that the cables are connected correctly and the printer is on. • If bi-directional communication is not turned on in the driver, it will also cause this message.
<p>"General Protection Fault", "Exception OE", "Spool32", or "Illegal Operation" messages appear.</p>	<p>Close all other applications, reboot Windows, and try printing again.</p>

Condition	Suggested solutions
“Fail To Print,” “A printer timeout error occurred,” “A printer timeout error occurred,” messages appear.	These messages may appear during printing. Just keep waiting until the printer finishes printing. If the message appears in standby mode or after printing has been completed, check the connection and/or whether an error has occurred.



Note

- Refer to Microsoft Windows User’s Guide that came with your computer for further information on Windows error messages.

Common PostScript problems

The following situations are PostScript language specific and may occur when several printer languages are being used.



Note

- To receive a printed or screen displayed message when PostScript errors occur, open the Print Options window and click the desired selection next to the PostScript errors section.

Condition	Possible cause	Suggested solutions
PostScript file can not be printed.	The PostScript driver may not be installed correctly.	<ul style="list-style-type: none"> • Print a configuration page and verify that the PostScript version is available for printing. • Install the PostScript driver; to installing the PS printer driver, see the Software Section. • If problem consists, contact a service representative.
“Limit Check Error” message appears.	The print job was too complex.	You might need to reduce the complexity of the page.
A PostScript error page prints.	Print job may not be PostScript.	Make sure that the print job is a PostScript job. Check to see whether the software application expected a setup or PostScript header file to be sent to the printer.
When print a document in Macintosh with Acrobat Reader 6.0 or higher, colors print incorrectly.	The resolution setting in the printer driver may not be matched with that in Acrobat Reader.	Make sure that the resolution setting in your printer driver matches that in Acrobat Reader.

Common Linux problems

Condition	Suggested solutions
The printer doesn’t print.	<ul style="list-style-type: none"> • Check if the printer driver is installed in your system. Open Unified Driver Configurator and switch to the Printers tab in Printers configuration window to look at the list of available printers. Make sure that your machine is displayed on the list. If not, please, invoke Add new printer wizard to set up your device. • Check if the printer is started. Open Printers configuration and select your machine on the printers list. Look at the description in the Selected printer pane. If its status contains “(stopped)” string, please, press the Start button. After that normal operation of the printer should be restored. The “stopped” status might be activated when some problems in printing occurred. • Check if your application has special print option such as “-oraw”. If “-oraw” is specified in the command line parameter then remove it to print properly. For Gimp front-end, select “print” -> “Setup printer” and edit command line parameter in the command item.
I encounter error “Unable to open mfp port device file!” when printing a document.	Please avoid changing print job parameters (via LPR GUI, for example) while a print job is in progress. Known versions of CUPS server break the print job whenever print options are changed and then try to restart the job from the beginning. Since Unified Linux Driver locks mfp port while printing, the abrupt termination of the driver keeps the port locked and therefore unavailable for subsequent print jobs. If this situation occurred, please, try to release the mfp port.
When printing a document over the network in SuSE 9.2, the printer does not print.	The CUPS (Common Unix Printing System) version distributed with SuSE Linux 9.2 (cups-1.1.21) has a problem with ipp (Internet Printing Protocol) printing. Use the socket printing instead of ipp or install later version of CUPS (cups-1.1.22 or higher).

Common Macintosh problems

Condition	Suggested solutions
The printer does not print PDF file correctly. Some parts of graphics, text, or illustrations are missing.	Incompatibility between the PDF file and the Acrobat products: Printing the PDF file as an image may solve this problem. Turn on Print As Image from the Acrobat printing options. Note: It will take longer to print when you print a PDF file as an image.
The document has printed, but the print job has not disappeared from the spooler in Mac OS 10.3.2.	Update your Mac OS to OS 10.3.3 or higher.
Some letters are not displayed normally during the cover sheet printing.	This problem is caused because Mac OS cannot find the font during the cover page printing. Alphanumeric characters, in the Billing Info field, are only allowed for printing on the cover page. Other characters will be broken on the printout.

10 Installing accessories

Your machine is a full-featured model that has been optimized to meet most of your printing needs. Recognizing that each user may have different requirements, however, Samsung makes several accessories available to enhance your machine's capabilities.

This chapter includes:

- **Precautions to take when installing accessories**
- **Installing a memory module**

Precautions to take when installing accessories

Disconnect the power cord

Never remove the control board cover while the power is turned on.

To avoid the possibility of an electrical shock, always disconnect the power cord when installing or removing ANY internal or external accessories.

Discharge static electricity

The control board and internal accessories (network interface card or memory module) are sensitive to static electricity. Before installing or removing any internal accessories, discharge static electricity from your body by touching something metal, such as the metal back plate on any device plugged into a grounded power source. If you walk around before finishing the installation, repeat this procedure to discharge any static electricity again.

Installing a memory module

Your machine has a dual in-line memory module (DIMM). Use this memory module slot to install additional memory.

When you are expanding the memory capacity, you can add a memory module to the vacant memory slot. Your machine has 32 MB memory, and you can add a 128 MB memory module.

Order information is provided for optional memory module. (See "Accessory" on page 7.1.)

- 1 Turn the machine off and unplug all cables from the machine.

- 2 Open the control board cover.

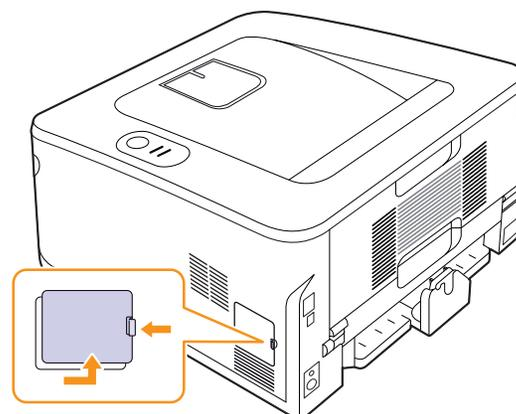

- 3 Take out a new memory module from the plastic bag.
- 4 Holding the memory module by the edges, align the memory module on the slot at about a 30-degree tilt. Make sure that the notches of the module and the grooves on the slot fit each other.

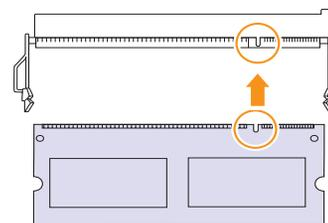

Note

The notches and grooves illustrated above may not match those on an actual memory module and its slot.

- 5 Press the memory module into the slot with care until you hear a 'click'.

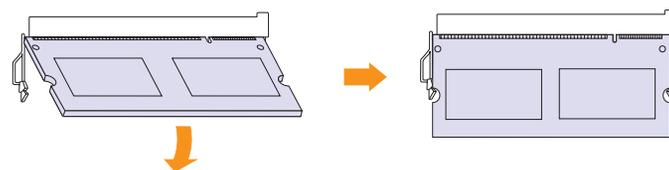

Caution

Do not press the memory module strongly or the module may be damaged. If the module does not seem to fit into the slot properly, carefully try the previous procedure again.

- 6 Replace the control board cover.
- 7 Reconnect the power cord and printer cable, and turn the machine on.

**Note**

To release the memory module, pull the two tabs on the sides of the slot outwards, then the module springs out.

Activating the added memory in the PS printer properties

After installing the memory module, you need to select it in the printer properties of the PostScript printer driver in order to use it.

- 1 Make sure that the PostScript printer driver is installed on your computer. For details about installing the PS printer driver, see Software section.
- 2 Click the Windows **Start** menu.
- 3 For Windows 2000, select **Settings** and then **Printers**.
For Windows XP/2003, select **Printers and Faxes**.
For Windows Vista/2008, select **Control Panel > Hardware and Sound > Printers**.
For Windows 7, select **Control Panel > Hardware and Sound > Devices and Printers**.
For Windows Server 2008 R2, select **Control Panel > Hardware > Devices and Printers**.
- 4 Select the **Samsung ML-2850 Series PS** printer.
- 5 Click the right mouse button on the printer icon and select **Properties**.
- 6 Select **Device Settings**.
- 7 Select the amount of memory you installed from **Printer Memory** in the **Installable Options** section.
- 8 Click **OK**.

11 Specifications

Printer specifications

Item	Specifications and description
Printing speed ^a	Up to 28 ppm in A4 (30 ppm in Letter) Duplex: 14 ipm in A4 (14.5 ipm in Letter)
Resolution	Up to 1200 x 1200 dpi effective output
Warm-up time	Less than 8 seconds
First print out time	8.5 seconds (From Ready) Sleep mode: 15.5 seconds
Power rating	AC 110 - 127 V or AC 220 - 240 V See the Rating label on the machine for the correct voltage, frequency (hertz) and type of current for your machine.
Power consumption	Average: 400 W Power save mode: Less than 8 W
Noise level ^b	Standby mode: Less than 26 dBA Printing mode: Less than 50 dBA
Toner cartridge life ^c	Standard Yield: Average cartridge yield 2,000 ^d standard pages. High Yield: Average cartridge yield 5,000 standard pages. (Ships with 2,000 pages Starter/Standard Toner Cartridge) ^e
Weight	8.99 Kg (including consumables)
Package weight	Paper: 2.4 Kg, Plastic: 0.3 Kg
Memory	32 MB (Max. 160 MB) 128 MB optional memory available Use only the Samsung-approved DIMM.
External dimensions (W x D x H)	364 X 369X 210 mm (14.3 X 14.5 X 8.3 inches)
Operating environment	Temperature: 50° F to 90° F (10° C to 32° C) Humidity: 20% to 80% RH
Printer language	PCL6 ^f , IBM ProPrinter, EPSON, PostScript 3, SPL
Fonts	1 bitmap, 45 scalable, 136 PostScript 3 fonts

Item	Specifications and description
Interface	<ul style="list-style-type: none"> • USB Interface Standard <ul style="list-style-type: none"> - USB 2.0: Hi-Speed USB 2.0 • Network Interface <ul style="list-style-type: none"> - Ethernet 10/100 Base TX wired LAN (ML-2851ND only)
OS compatibility	<ul style="list-style-type: none"> • Windows 2000/XP/2003/2008/Vista/7/Server 2008 R2 • Various Linux OS • Mac 10.3 or 8.6 ~ 9.2/10.1 ~ 10.6
Printer drivers ^g	<ul style="list-style-type: none"> • PCL6 driver: 2000/XP/2003/2008/Vista/7/Server 2008 R2 • PostScript driver: 2000/XP/2003/2008/Vista/7/Server 2008 R2
Options	250-sheet tray
Fusing temperature	180° C (356° F)

- a. Print speed will be affected by operating system used, computing performance, application software, connection method, print media type, print media size, and job complexity.
- b. Sound pressure Level, ISO7779
- c. The number of pages may be affected by operating environment, printing interval, print media type, and print media size.
- d. Declared yield value in accordance with ISO/IEC 19752
- e. It varies depending on the product configuration.
- f. Compatible with PCL6 version 2.1
- g. Please visit www.samsungprinter.com to download the latest software version.

INDEX

A

accessories, order information 7.1

C

cleaning
 inside 8.1
 outside 8.1
component location 1.2
configuration page, print 8.4
control panel
 LED 9.5
 overview 1.3

D

demo page, print 2.1

J

jam, clear 9.1

L

LED, meaning 1.3
Linux problems 9.10
loading paper
 tray 1/optional tray 2 5.5

M

Macintosh problems 9.11
maintenance parts 8.4
manual feed mode, use 5.6
memory module
 installing 10.1

N

network operating systems 4.1

O

output location 5.7

P

paper guidelines 5.3
paper jam, clear
 around the toner cartridge 9.2
 duplex area 9.3
 multi-purpose tray 9.2
 optional tray 2 9.1
 paper exit area 9.3
 tray 1 9.1
paper level indicator 5.4
paper load
 tray 1/optional tray 2 5.5
paper size
 specifications 5.2
paper type
 specifications 5.2
PostScript problems 9.10
print quality problems, solve 9.7
printing
 configuration page 8.4
 demo page 2.1
 problems 9.5
problem, solve
 checklist 9.5
 Linux 9.10
 Macintosh 9.11
 paper jams 9.1
 printing 9.5
 printing quality 9.7
 PS errors 9.10
 Windows 9.9

Q

quality problems 9.7

R

redistributing, toner cartridge 8.2

replacing, toner cartridge 8.3

S

special print media, guidelines 5.3
specification, printer 11.1
supplies, order information 7.1
system requirements
 Linux 3.2
 Macintosh 3.2
 Windows 3.2

T

toner cartridge
 maintaining 8.2
 redistributing 8.2
 replacing 8.3
toner save mode, use 2.1
troubleshooting 9.1

W

Windows problems 9.9



Samsung Printer

Software section

SOFTWARE SECTION

CONTENTS

Chapter 1: **INSTALLING PRINTER SOFTWARE IN WINDOWS**

Installing Printer Software	4
Installing Software for Local Printing	4
Installing Software for Network Printing	7
Reinstalling Printer Software	10
Removing Printer Software	11

Chapter 2: **BASIC PRINTING**

Printing a Document	12
Printing to a file (PRN)	13
Printer Settings	13
Layout Tab	14
Paper Tab	14
Graphics Tab	15
Extras Tab	16
About Tab	17
Printer Tab	17
Using a Favorite Setting	17
Using Help	17

Chapter 3: **ADVANCED PRINTING**

Printing Multiple Pages on One Sheet of Paper (N-Up Printing)	18
Printing Posters	19
Printing Booklets	19
Printing on Both Sides of Paper	20
Printing a Reduced or Enlarged Document	20
Fitting Your Document to a Selected Paper Size	20
Using Watermarks	21

Using an Existing Watermark	21
Creating a Watermark	21
Editing a Watermark	21
Deleting a Watermark	21
Using Overlays	22
What is an Overlay?	22
Creating a New Page Overlay	22
Using a Page Overlay	22
Deleting a Page Overlay	22

Chapter 4: USING WINDOWS POSTSCRIPT DRIVER

Printer Settings	23
Advanced	23
Using Help	23

Chapter 5: SHARING THE PRINTER LOCALLY

Setting Up a Host Computer	24
Setting Up a Client Computer	24

Chapter 6: USING SMART PANEL

Understanding Smart Panel	25
Opening the Troubleshooting Guide	26
Using Printer Settings Utility	26
Using Onscreen Help File	26
Changing the Smart Panel Program Settings	26

Chapter 7: USING YOUR PRINTER IN LINUX

Getting Started	27
Installing the Unified Linux Driver	27
Installing the Unified Linux Driver	27
Uninstalling the Unified Linux Driver	28
Using the Unified Driver Configurator	29
Opening the Unified Driver Configurator	29
Printers Configuration	29

Ports Configuration	30
Configuring Printer Properties	30
Printing a Document	31
Printing from Applications	31
Printing Files	31

Chapter 8: USING YOUR PRINTER WITH A MACINTOSH

Installing Software	32
Printer driver	32
Setting Up the Printer	33
For a Network-connected	33
For a USB-connected	33
Printing	34
Printing a Document	34
Changing Printer Settings	34
Printing Multiple Pages on One Sheet of Paper	36
Duplex Printing	36

1 Installing Printer Software in Windows

This chapter includes:

- **Installing Printer Software**
- **Reinstalling Printer Software**
- **Removing Printer Software**

NOTE: The following procedure is based on Windows XP, for other operating systems, refer to the corresponding Windows user's guide or online help.

Installing Printer Software

You can install the printer software for local printing or network printing. To install the printer software on the computer, perform the appropriate installation procedure depending on the printer in use.

A printer driver is software that lets your computer communicate with your printer. The procedure to install drivers may differ depending on the operating system you are using.

All applications should be closed on your PC before beginning installation.

Installing Software for Local Printing

A local printer is a printer directly attached to your computer using the printer cable supplied with your printer, such as a USB or parallel cable. If your printer is attached to a network, skip this step and go to "Installing Software for Network Printing" on page 7.

You can install the printer software using the typical or custom method.

NOTE: If the "New Hardware Wizard" window appears during the installation procedure, click  in the upper right corner of the box to close the window, or click **Cancel**.

Typical Installation

This is recommended for most users. All components necessary for printer operations will be installed.

- 1 Make sure that the printer is connected to your computer and powered on.
- 2 Insert the supplied CD-ROM into your CD-ROM drive. The CD-ROM should automatically run, and an installation window appears. If the installation window does not appear, click **Start** and then **Run**. Type **X:\Setup.exe**, replacing "X" with the letter which represents your drive and click **OK**. If you use Windows Vista, Windows 7 and Windows Server 2008 R2, click **Start** → **All programs** → **Accessories** → **Run**, and type **X:\Setup.exe**. If the **AutoPlay** window appears in Windows Vista, Windows 7 and Windows Server 2008 R2, click **Run Setup.exe** in **Install or run program** field, and click **Continue** in the **User Account Control** window.

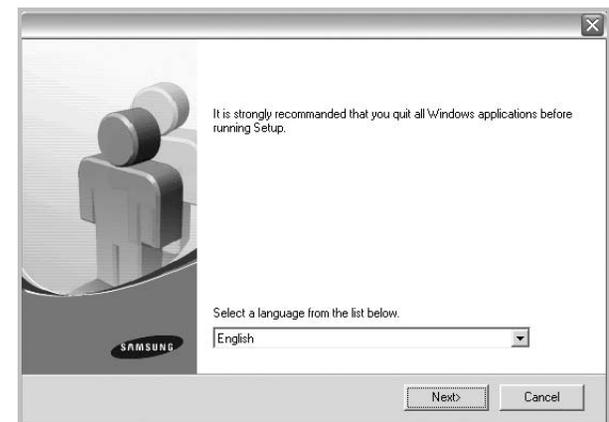

- 3 Click **Next**.
 - If necessary, select a language from the drop-down list.
- 4 Select **Typical installation for a local printer**. Click **Next**.

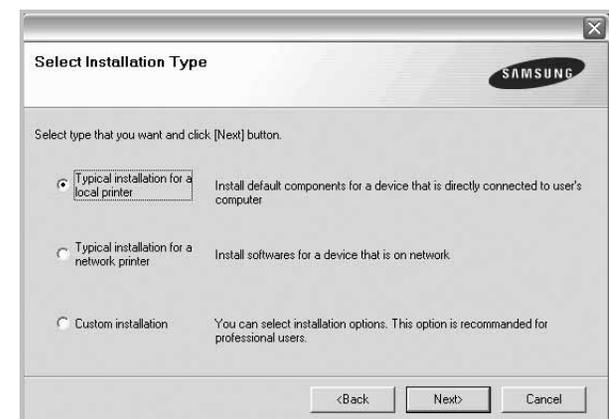

NOTE: If your printer is not already connected to the computer, the following window will appear.

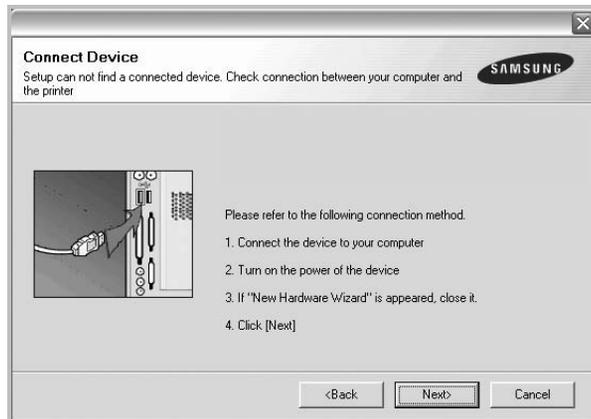

- After connecting the printer, click **Next**.
- If you don't want to connect the printer at this time, click **Next**, and **No** on the following screen. Then the installation will start and a test page will not be printed at the end of the installation.
- *The installation window that appears in this User's Guide may differ depending on the printer and interface in use.*

- 5 After the installation is finished, a window asking you to print a test page appears. If you choose to print a test page, select the checkbox and click **Next**. Otherwise, just click **Next** and skip to step 7.
- 6 If the test page prints out correctly, click **Yes**. If not, click **No** to reprint it.
- 7 To register yourself as a user of Samsung Printers in order to receive information from Samsung, select the checkbox and click **Finish**. You are now sent to the Samsung web site. Otherwise, just click **Finish**.

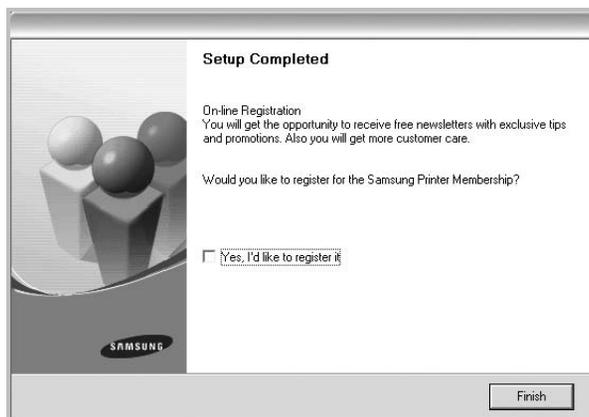

NOTE: After setup is complete, if your printer driver doesn't work properly, reinstall the printer driver. See "Reinstalling Printer Software" on page 10.

Custom Installation

You can choose individual components to install.

- 1 Make sure that the printer is connected to your computer and powered on.
- 2 Insert the supplied CD-ROM into your CD-ROM drive. The CD-ROM should automatically run, and an installation window appears. If the installation window does not appear, click **Start** and then **Run**. Type **X:\Setup.exe**, replacing "X" with the letter which represents your drive and click **OK**. If you use Windows Vista, Windows 7 and Windows Server 2008 R2, click **Start** → **All programs** → **Accessories** → **Run**, and type **X:\Setup.exe**. If the **AutoPlay** window appears in Windows Vista, Windows 7 and Windows Server 2008 R2, click **Run Setup.exe** in **Install or run program** field, and click **Continue** in the **User Account Control** window.

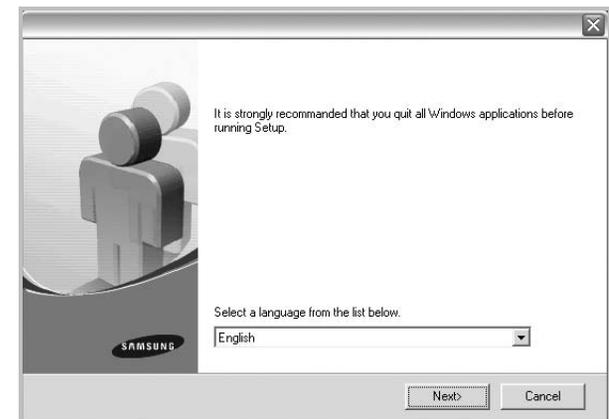

- 3 Click **Next**.
 - If necessary, select a language from the drop-down list.
 - **View User's Guide:** Allows you to view the User's Guide. If your computer doesn't have Adobe Acrobat, click on this option and it will automatically install Adobe Acrobat Reader for you.

- 4 Select **Custom installation**. Click **Next**.

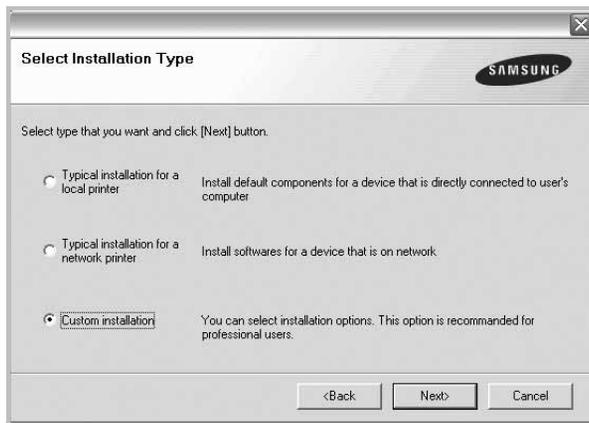

- 5 Select your printer and click **Next**.

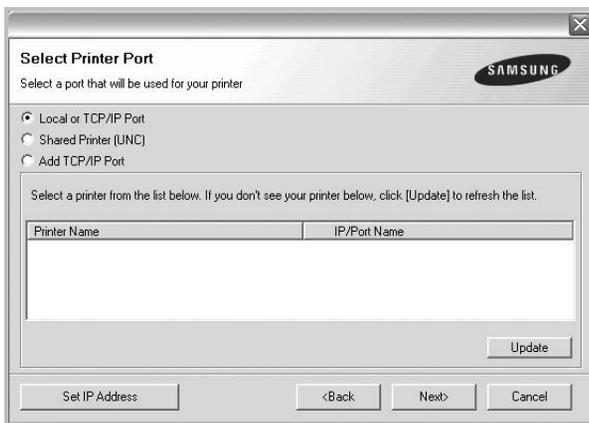

NOTE: If your printer is not already connected to the computer, the following window will appear.

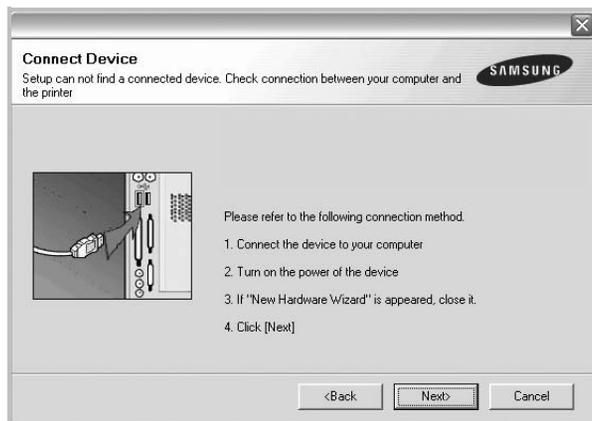

- After connecting the printer, click **Next**.
- If you don't want to connect the printer at this time, click **Next**, and **No** on the following screen. Then the installation will start and a test page will not be printed at the end of the installation.

• *The installation window that appears in this User's Guide may differ depending on the printer and interface in use.*

- 6 Select the components to be installed and click **Next**.

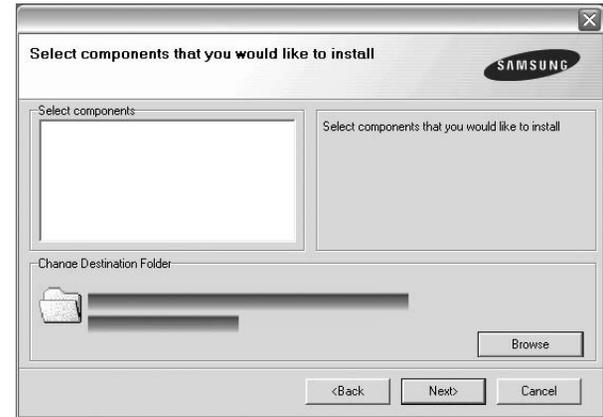

NOTE: You can change the desired installation folder by clicking [**Browse**].

- 7 After the installation is finished, a window asking you to print a test page appears. If you choose to print a test page, select the checkbox and click **Next**. Otherwise, just click **Next** and skip to step 9.
- 8 If the test page prints out correctly, click **Yes**. If not, click **No** to reprint it.
- 9 To register yourself as a user of Samsung Printers in order to receive information from Samsung, select the checkbox and click **Finish**. You are now sent to the Samsung web site. Otherwise, just click **Finish**.

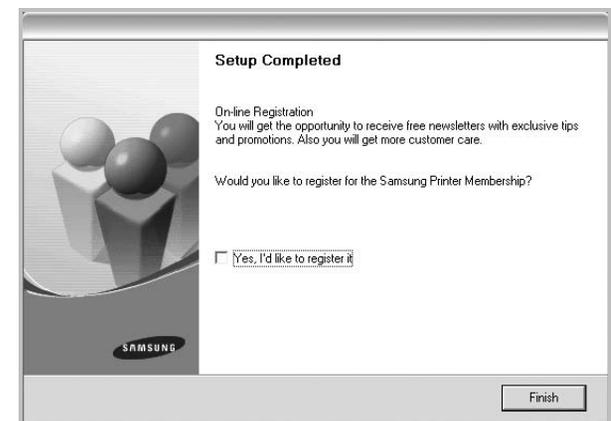

Installing Software for Network Printing

When you connect your printer to a network, you must first configure the TCP/IP settings for the printer. After you have assigned and verified the TCP/IP settings, you are ready to install the software on each computer on the network.

You can install the printer software using the typical or custom method.

Typical Installation

This is recommended for most users. All components necessary for printer operations will be installed.

- 1 Make sure that the printer is connected to your network and powered on. For details about connecting to the network, see the supplied printer's User's Guide.
- 2 Insert the supplied CD-ROM into your CD-ROM drive. The CD-ROM should automatically run, and an installation window appears. If the installation window does not appear, click **Start** and then **Run**. Type **X:\Setup.exe**, replacing "X" with the letter which represents your drive and click **OK**. If you use Windows Vista, Windows 7 and Windows Server 2008 R2, click **Start** → **All programs** → **Accessories** → **Run**, and type **X:\Setup.exe**. If the **AutoPlay** window appears in Windows Vista, Windows 7 and Windows Server 2008 R2, click **Run Setup.exe** in **Install or run program** field, and click **Continue** in the **User Account Control** window.

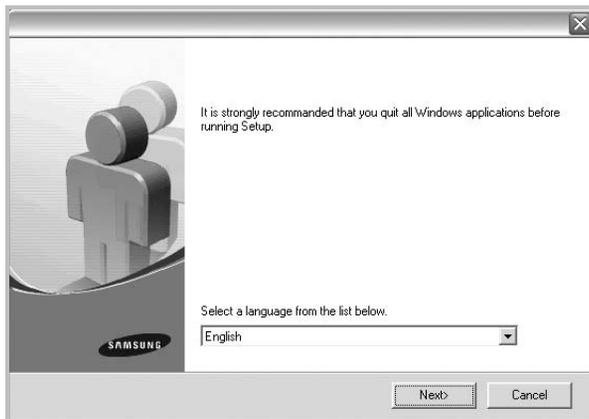

- 3 Click **Next**.
 - If necessary, select a language from the drop-down list.
 - **View User's Guide:** Allows you to view the User's Guide. If your computer doesn't have Adobe Acrobat, click on this option and it will automatically install Adobe Acrobat Reader for you.

- 4 Select **Typical installation for a network printer**. Click **Next**.

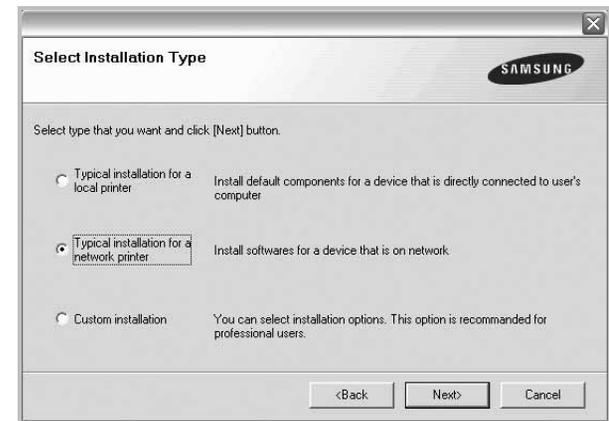

- 5 The list of printers available on the network appears. Select the printer you want to install from the list and then click **Next**.

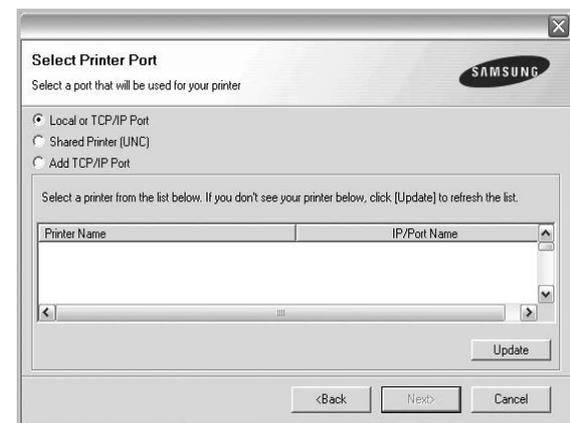

- If you do not see your printer on the list, click **Update** to refresh the list, or select **Add TCP/IP Port** to add your printer to the network. To add the printer to the network, enter the port name and the IP address for the printer.

To verify your printer's IP address or the MAC address, print a Network Configuration page.

- To find a shared network printer (UNC Path), select **Shared Printer [UNC]** and enter the shared name manually or find a shared printer by clicking the **Browse** button.

NOTE: If you cannot find your machine in network, please turn off the firewall and click **Update**.

- 6 After the installation is finished, a window appears asking you to print a test page and to register yourself as a user of Samsung Printers in order to receive information from

Samsung. If you so desire, select the corresponding checkbox(es) and click **Finish**.

Otherwise, just click **Finish**.

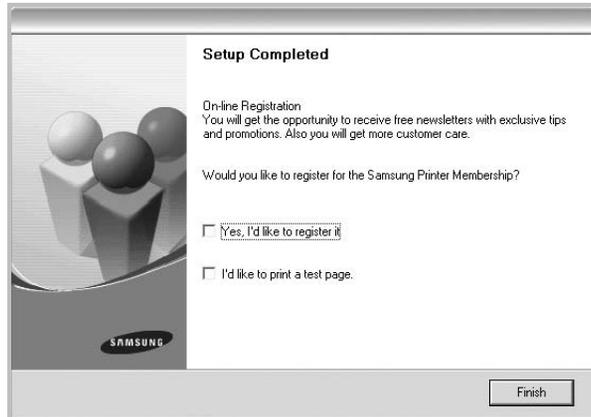

NOTE: After setup is complete, if your printer driver doesn't work properly, reinstall the printer driver. See "Reinstalling Printer Software" on page 10.

Custom Installation

You can choose individual components to install and set a specific IP address.

- 1 Make sure that the printer is connected to your network and powered on. For details about connecting to the network, see the supplied printer's User's Guide.
- 2 Insert the supplied CD-ROM into your CD-ROM drive. The CD-ROM should automatically run, and an installation window appears. If the installation window does not appear, click **Start** and then **Run**. Type **X:\Setup.exe**, replacing "X" with the letter which represents your drive and click **OK**. If you use Windows Vista, Windows 7 and Windows Server 2008 R2, click **Start** → **All programs** → **Accessories** → **Run**, and type **X:\Setup.exe**. If the **AutoPlay** window appears in Windows Vista, Windows 7 and Windows Server 2008 R2, click **Run**

Setup.exe in **Install or run program** field, and click **Continue** in the **User Account Control** window.

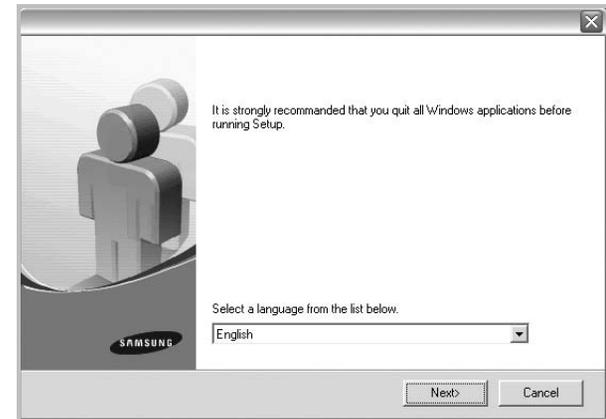

- 3 Click **Next**.
 - If necessary, select a language from the drop-down list.
 - **View User's Guide:** Allows you to view the User's Guide. If your computer doesn't have Adobe Acrobat, click on this option and it will automatically install Adobe Acrobat Reader for you.
- 4 Select **Custom installation**. Click **Next**.

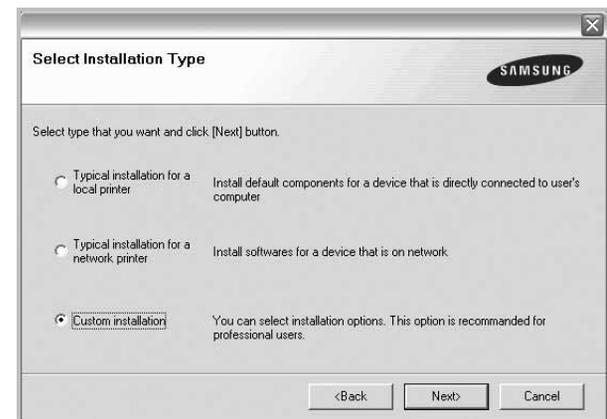

- 5 The list of printers available on the network appears. Select the printer you want to install from the list and then click **Next**.

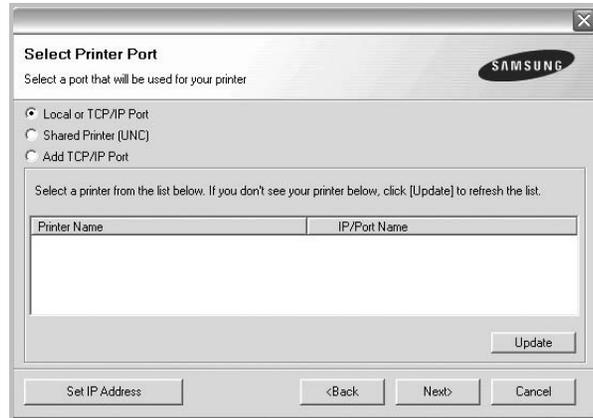

- If you do not see your printer on the list, click **Update** to refresh the list, or select **Add TCP/IP Port** to add your printer to the network. To add the printer to the network, enter the port name and the IP address for the printer.

To verify your printer's IP address or the MAC address, print a Network Configuration page.

- To find a shared network printer (UNC Path), select **Shared Printer [UNC]** and enter the shared name manually or find a shared printer by clicking the **Browse** button.

NOTE: If you cannot find your machine in network, please turn off the firewall and click **Update**.

TIP: If you want to set a specific IP address on a specific network printer, click the **Set IP Address** button. The Set IP Address window appears. Do as follows:

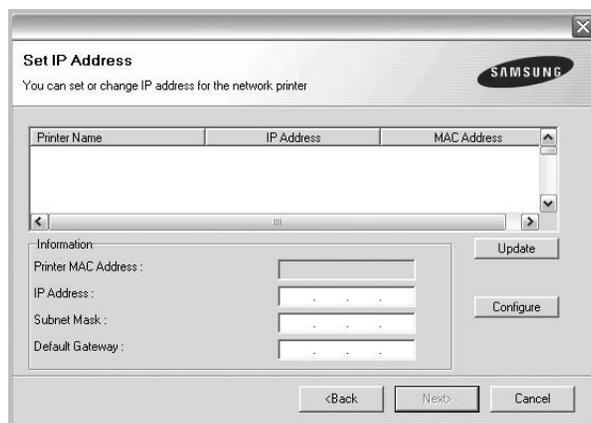

- a. Select a printer to be set with a specific IP address from the list.

- b. Configure an IP address, subnet mask, and gateway for the printer manually and click **Configure** to set the specific IP address for the network printer.
- c. Click **Next**.

- 6 Select the components to be installed. After selecting the components, the following window appears. You can also change the printer name, set the printer to be shared on the network, set the printer as the default printer, and change the port name of each printer. Click **Next**.



To install this software on a server, select the **Setting up this printer on a server** checkbox.

- 7 After the installation is finished, a window appears asking you to print a test page and to register yourself as a user of Samsung Printers in order to receive information from Samsung. If you so desire, select the corresponding checkbox(es) and click **Finish**.

Otherwise, just click **Finish**.

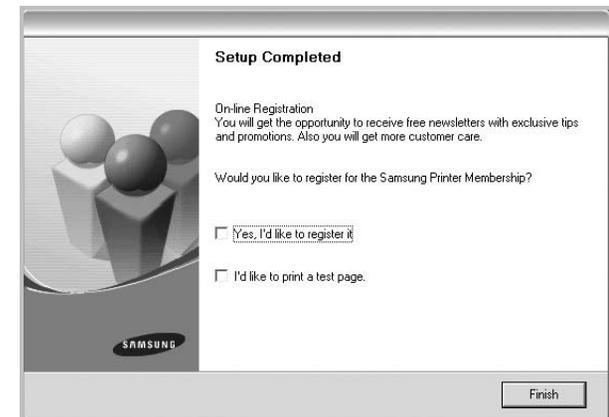

NOTE: After setup is complete, if your printer driver doesn't work properly, reinstall the printer driver. See "Reinstalling Printer Software" on page 10.

Reinstalling Printer Software

You can reinstall the software if installation fails.

- 1 Start Windows.
- 2 From the **Start** menu select **Programs** or **All Programs** → **your printer driver name** → **Maintenance**.
- 3 Select **Repair** and click **Next**.
- 4 The list of printers available on the network appears. Select the printer you want to install from the list and then click **Next**.

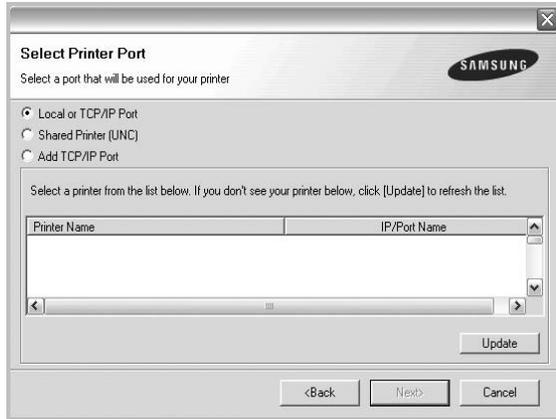

- If you do not see your printer on the list, click **Update** to refresh the list, or select **Add TCP/IP Port** to add your printer to the network. To add the printer to the network, enter the port name and the IP address for the printer.
- To find a shared network printer (UNC Path), select **Shared Printer [UNC]** and enter the shared name manually or find a shared printer by clicking the **Browse** button.

You will see a component list so that you can reinstall any item individually.

NOTE: If your printer is not already connected to the computer, the following window will appear.

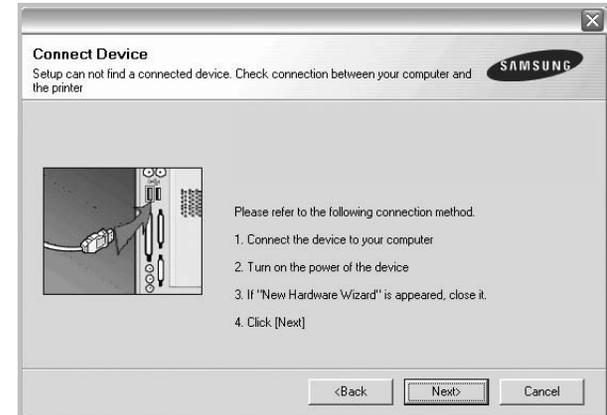

- After connecting the printer, click **Next**.
- If you don't want to connect the printer at this time, click **Next**, and **No** on the following screen. Then the installation will start and a test page will not be printed at the end of the installation.
- *The reinstallation window that appears in this User's Guide may differ depending on the printer and interface in use.*

- 5 Select the components you want to reinstall and click **Next**.

If you installed the printer software for local printing and you select **your printer driver name**, the window asking you to print a test page appears. Do as follows:

- a. To print a test page, select the check box and click **Next**.
 - b. If the test page prints out correctly, click **Yes**.
If it doesn't, click **No** to reprint it.
- 6 When the reinstallation is done, click **Finish**.

Removing Printer Software

- 1 Start Windows.
- 2 From the **Start** menu select **Programs** or **All Programs** → **your printer driver name** → **Maintenance**.
- 3 Select **Remove** and click **Next**.
You will see a component list so that you can remove any item individually.
- 4 Select the components you want to remove and then click **Next**.
- 5 When your computer asks you to confirm your selection, click **Yes**.
The selected driver and all of its components are removed from your computer.
- 6 After the software is removed, click **Finish**.

2 Basic Printing

This chapter explains the printing options and common printing tasks in Windows.

This chapter includes:

- **Printing a Document**
- **Printing to a file (PRN)**
- **Printer Settings**
 - **Layout Tab**
 - **Paper Tab**
 - **Graphics Tab**
 - **Extras Tab**
 - **About Tab**
 - **Printer Tab**
 - **Using a Favorite Setting**
 - **Using Help**

Printing a Document

NOTES:

- Your printer driver **Properties** window that appears in this User's Guide may differ depending on the printer in use. However the composition of the printer properties window is similar.
 - *Check the Operating System(s) that are compatible with your printer. Please refer to the OS Compatibility section of Printer Specifications in your Printer User's Guide.*
 - If you need to know the exact name of your printer, you can check the supplied CD-ROM.
-

The following procedure describes the general steps required for printing from various Windows applications. The exact steps for printing a document may vary depending on the application program you are using. Refer to the User's Guide of your software application for the exact printing procedure.

- 1 Open the document you want to print.
- 2 Select **Print** from the **File** menu. The Print window is displayed. It may look slightly different depending on your application.

The basic print settings are selected within the Print window. These settings include the number of copies and print range.

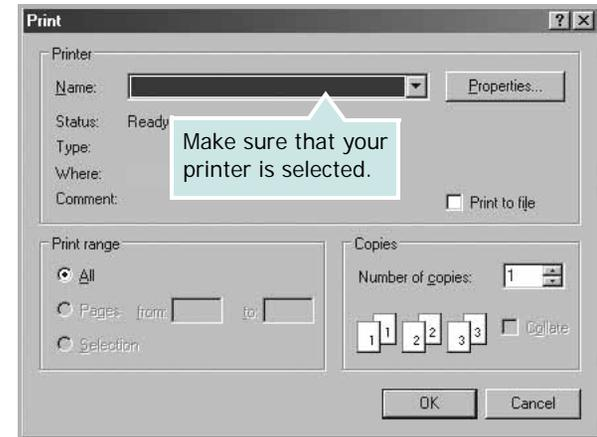

- 3 Select **your printer driver** from the **Name** drop-down list.

To take advantage of the printer features provided by your printer driver, click **Properties** or **Preferences** in the application's Print window. For details, see "Printer Settings" on page 13.

If you see **Setup**, **Printer**, or **Options** in your Print window, click it instead. Then click **Properties** on the next screen.

Click **OK** to close the printer properties window.

- 4 To start the print job, click **OK** or **Print** in the Print window.

Printing to a file (PRN)

You will sometimes need to save the print data as a file for your purpose.

To create a file:

- 1 Check the **Print to file** box at the **Print** window.

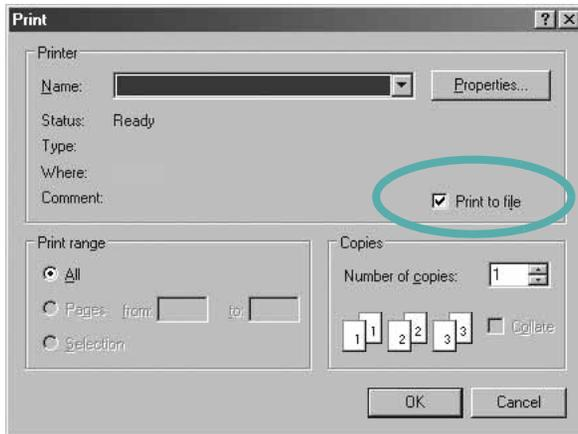

- 2 Select the folder and assign a name of the file and then click OK.

Printer Settings

You can use the printer properties window, which allows you to access all of the printer options you need when using your printer. When the printer properties are displayed, you can review and change the settings needed for your print job.

Your printer properties window may differ, depending on your operating system. This Software User's Guide shows the Properties window for Windows XP.

Your printer driver **Properties** window that appears in this User's Guide may differ depending on the printer in use.

If you access printer properties through the Printers folder, you can view additional Windows-based tabs (refer to your Windows User's Guide) and the Printer tab (see "Printer Tab" on page 17).

NOTES:

- Most Windows applications will override settings you specify in the printer driver. Change all print settings available in the software application first, and change any remaining settings using the printer driver.
 - The settings you change remain in effect only while you are using the current program. **To make your changes permanent**, make them in the Printers folder.
 - The following procedure is for Windows XP. For other Windows OS, refer to the corresponding Windows User's Guide or online help.
 1. Click the Windows **Start** button.
 2. Select **Printers and Faxes**.
 3. Select **your printer driver icon**.
 4. Right-click on the printer driver icon and select **Printing Preferences**.
 5. Change the settings on each tab, click OK.
-

Layout Tab

The **Layout** tab provides options to adjust how the document appears on the printed page. The **Layout Options** includes **Multiple Pages per Side**, **Poster Printing** and **Booklet Printing**. See “Printing a Document” on page 12 for more information on accessing printer properties.

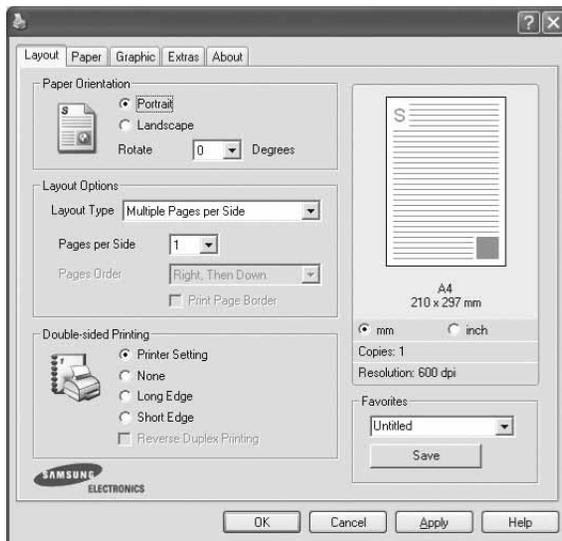

Paper Orientation

Paper Orientation allows you to select the direction in which information is printed on a page.

- **Portrait** prints across the width of the page, letter style.
- **Landscape** prints across the length of the page, spreadsheet style.
- **Rotate** allows you to rotate the page the selected degrees.



▲ Portrait



▲ Landscape

Layout Options

Layout Options allows you to select advanced printing options. You can choose **Multiple Pages per Side** and **Poster Printing**.

- For details, see “Printing Multiple Pages on One Sheet of Paper (N-Up Printing)” on page 18.
- For details, see “Printing Posters” on page 19
- For details, see “Printing Booklets” on page 19

Double-sided Printing

Double-sided Printing allows you to print on both sides of paper. *If this option does not appear, your printer does not have this feature.*

- For details, see “Printing on Both Sides of Paper” on page 20.

Paper Tab

Use the following options to set the basic paper handling specifications when you access the printer properties. See “Printing a Document” on page 12 for more information on accessing printer properties.

Click the **Paper** tab to access various paper properties.

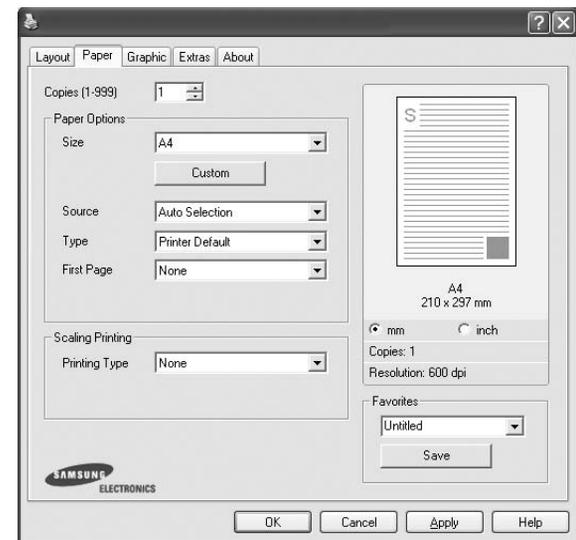

Copies

Copies allows you to choose the number of copies to be printed. You can select 1 to 999 copies.

Paper Options

Size

Size allows you to set the size of paper you loaded in the tray. If the required size is not listed in the **Size** box, click **Custom**. When the **Custom Paper Setting** window appears, set the paper size and click **OK**. The setting appears in the list so that you can select it.

Source

Make sure that **Source** is set to the corresponding paper tray. Use **Manual Feeder** when printing on special materials like envelopes and transparencies. You have to load one sheet at a time into the Manual Tray or Multi-Purpose Tray. If the paper source is set to **Auto Selection**, the printer automatically picks up print material in the following tray order: Manual Tray or Multi-Purpose Tray, Tray n.

Type

Set **Type** to correspond to the paper loaded in the tray from which you want to print. This will let you get the best quality printout. If not, print quality may not be achieved as you want.

Cotton: 20 lb to 24 lb (75~90 g/m²) cotton paper such as Gilbert 25 % and Gilbert 100 %.

Plain Paper: Normal plain paper. Select this type if your printer is monochrome and printing on the 16 lb (60 g/m²) cotton paper.

Recycled Paper: 20 lb to 24 lb (75~90 g/m²) recycled paper.

Color Paper: 20 lb to 24 lb (75~90 g/m²) color-backgrounded paper.

Archive Paper: If you need to keep print-out for a long period time such as archives, select this option.

First Page

This property allows you to print the first page using a different paper type from the rest of the document. You can select the paper source for the first page.

For example, load thick stock for the first page into the Multi-purpose Tray, and plain paper into Tray n. Then, select **Tray n** in the **Source** option and **Multi-Purpose Tray** in the **First Page** option. *If this option does not appear, your printer does not have this feature.*

Scaling Printing

Scaling Printing allows you to automatically or manually scale your print job on a page. You can choose from **None**, **Reduce/Enlarge**, and **Fit to Page**.

- For details, see "Printing a Reduced or Enlarged Document" on page 20.
- For details, see "Fitting Your Document to a Selected Paper Size" on page 20.

Graphics Tab

Use the following Graphic options to adjust the print quality for your specific printing needs. See "Printing a Document" on page 12 for more information on accessing printer properties. Click the **Graphic** tab to display the properties shown below.

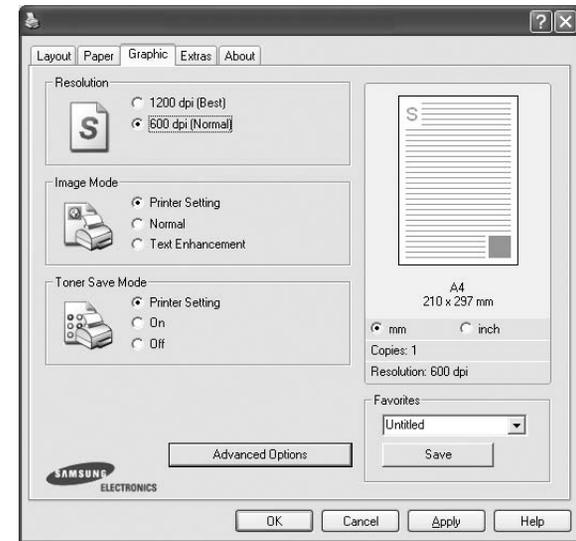

Resolution

The Resolution options you can select may vary depending on your printer model. The higher the setting, the sharper the clarity of printed characters and graphics. The higher setting also may increase the time it takes to print a document.

Image Mode

The available options are Normal and Text Enhance. *Some printers do not support this feature.*

- **Printer Setting:** If you select this option, this feature is determined by the setting you've made on the control panel of the printer.
- **Normal:** This setting is for normal documents.
- **Text Enhance:** Image Mode allows the user to enhance printouts.

Toner Save Mode

Selecting this option extends the life of your toner cartridge and reduces your cost per page without a significant reduction in print quality. *Some printers do not support this feature.*

- **Printer Setting:** If you select this option, this feature is determined by the setting you've made on the control panel of the printer.
- **On:** Select this option to allow the printer to use less toner on each page.
- **Off:** If you don't need to save toner when printing a document, select this option.

Advanced Options

You can set advanced settings by clicking the **Advanced Options** button.

- **TrueType Options:** This option determines what the driver tells the printer about how to image the text in your document. Select the appropriate setting according to the status of your document.
 - **Download as Outline:** When this option is selected, the driver will download any TrueType fonts that are used in your document not already stored (resident) on your printer. If, after printing a document, you find that the fonts did not print correctly, choose Download as bit image and resubmit your print job. The Download as bit image setting is often useful when printing Adobe. *This feature is available only when you use the PCL printer driver.*
 - **Download as Bitmap:** When this option is selected, the driver will download the font data as bitmap images. Documents with complicated fonts, such as Korean or Chinese, or various other fonts, will print faster in this setting.
 - **Print as Graphics:** When this option is selected, the driver will download any fonts as graphics. When printing documents with high graphic content and relatively few TrueType fonts, printing performance (speed) may be enhanced in this setting.
- **Print All Text To Black:** When the **Print All Text To Black** option is checked, all text in your document prints solid black, regardless of the color it appears on the screen.
- **Print All Text To Darken:** When the **Print All Text To Darken** option is checked, all text in your document is allowed to print darker than on a normal document. *Some printers do not support this feature.*

Extras Tab

You can select output options for your document. See “Printing a Document” on page 12 for more information about accessing the printer properties.

Click the **Extras** tab to access the following feature:

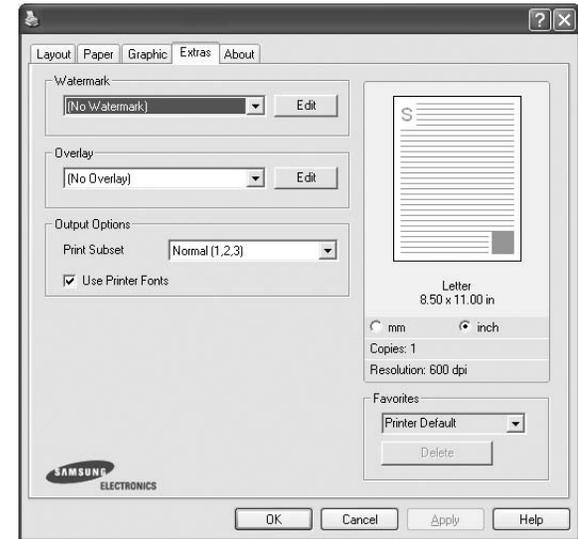

Watermark

You can create a background text image to be printed on each page of your document. For details, see “Using Watermarks” on page 21.

Overlay

Overlays are often used to take the place of preprinted forms and letterhead paper. For details, see “Using Overlays” on page 22.

Output Options

- **Print Subset:** You can set the sequence in which the pages print. Select the print order from the drop-down list.
 - **Normal (1,2,3):** Your printer prints all pages from the first page to the last page.
 - **Reverse All Pages (3,2,1):** Your printer prints all pages from the last page to the first page.
 - **Print Odd Pages:** Your printer prints only the odd numbered pages of the document.
 - **Print Even Pages:** Your printer prints only the even numbered pages of the document.
- **Use Printer Fonts:** When Use Printer Fonts is checked, the printer uses the fonts that are stored in its memory (resident fonts) to print your document, rather than downloading the fonts used in your document. Because downloading fonts takes time, selecting this option can speed up your printing time. When using Printer fonts, the printer will try to match the fonts used in your document to those stored in its memory. If, however, you use fonts in your document that are very different from those resident in the printer, your printed output will appear very different from what it looks like on the screen. *This feature is available only when you use the PCL printer driver.*

About Tab

Use the **About** tab to display the copyright notice and the version number of the driver. If you have an Internet browser, you can connect to the Internet by clicking on the web site icon. See "Printing a Document" on page 12 for more information about accessing printer properties.

Printer Tab

If you access printer properties through the **Printers** folder, you can view the **Printer** tab. You can set the printer configuration.

The following procedure is for Windows XP. For other Windows OS, refer to the corresponding Windows User's Guide or online help.

- 1 Click the Windows **Start** menu.
- 2 Select **Printers and Faxes**.
- 3 Select **your printer driver** icon.
- 4 Right-click on the printer driver icon and select **Properties**.
- 5 Click the **Printer** tab and set the options.

Using a Favorite Setting

The **Favorites** option, which is visible on each properties tab, allows you to save the current properties settings for future use.

To save a **Favorites** item:

- 1 Change the settings as needed on each tab.
- 2 Enter a name for the item in the **Favorites** input box.

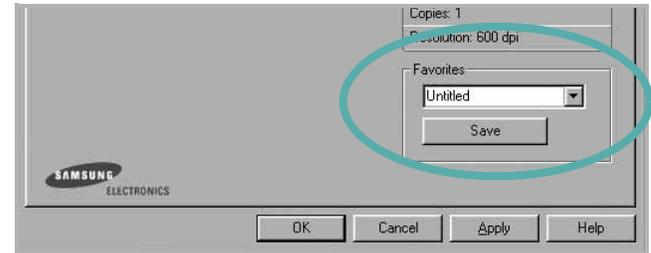

- 3 Click **Save**.

When you save **Favorites**, all current driver settings are saved.

To use a saved setting, select the item from the **Favorites** drop down list. The printer is now set to print according to the Favorites setting you selected.

To delete a Favorites item, select it from the list and click **Delete**.

You can also restore the printer driver's default settings by selecting **Printer Default** from the list.

Using Help

Your printer has a help screen that can be activated by clicking the **Help** button in the printer properties window. These help screens give detailed information about the printer features provided by the printer driver.

You can also click  from the upper right corner of the window, and then click on any setting.

3 Advanced Printing

This chapter explains printing options and advanced printing tasks.

NOTE:

- Your printer driver **Properties** window that appears in this User's Guide may differ depending on the printer in use. However the composition of the printer properties window is similar.
 - If you need to know the exact name of your printer, you can check the supplied CD-ROM.
-

This chapter includes:

- **Printing Multiple Pages on One Sheet of Paper (N-Up Printing)**
- **Printing Posters**
- **Printing Booklets**
- **Printing on Both Sides of Paper**
- **Printing a Reduced or Enlarged Document**
- **Fitting Your Document to a Selected Paper Size**
- **Using Watermarks**
- **Using Overlays**

Printing Multiple Pages on One Sheet of Paper (N-Up Printing)



You can select the number of pages to print on a single sheet of paper. To print more than one page per sheet, the pages will be reduced in size and arranged in the order you specify. You can print up to 16 pages on one sheet.

- 1** To change the print settings from your software application, access printer properties. See “Printing a Document” on page 12.
- 2** From the **Layout** tab, choose **Multiple Pages per Side** in the **Layout Type** drop-down list.
- 3** Select the number of pages you want to print per sheet (1, 2, 4, 6, 9, or 16) in the **Pages per Side** drop-down list.
- 4** Select the page order from the **Page Order** drop-down list, if necessary.
Check **Print Page Border** to print a border around each page on the sheet.
- 5** Click the **Paper** tab, select the paper source, size, and type.
- 6** Click **OK** and print the document.

Printing Posters

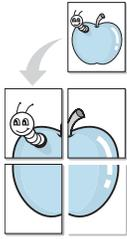

This feature allows you to print a single-page document onto 4, 9, or 16 sheets of paper, for the purpose of pasting the sheets together to form one poster-size document.

NOTE: The poster printing option is available when 600 dpi is selected in the resolution option on the **Graphic** tab.

- 1 To change the print settings from your software application, access printer properties. See “Printing a Document” on page 12.
- 2 Click the **Layout** tab, select **Poster Printing** in the **Layout Type** drop-down list.
- 3 Configure the poster option:
You can select the page layout from **Poster<2x2>**, **Poster<3x3>** or **Poster<4x4>**. If you select **Poster<2x2>**, the output will be automatically stretched to cover 4 physical pages.

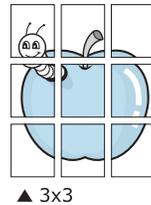
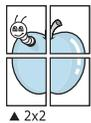

Specify an overlap in millimeters or inches to make it easier to pasting the sheets together.

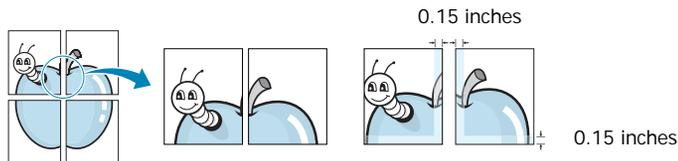

- 4 Click the **Paper** tab, select the paper source, size, and type.
- 5 Click **OK** and print the document. You can complete the poster by pasting the sheets together.

Printing Booklets

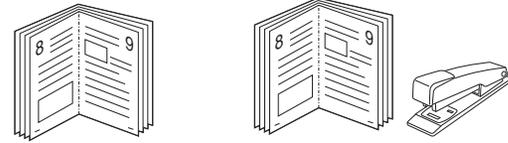

This printer feature allows you to print your document on both sides of the paper and arranges the pages so that the paper can be folded in half after printing to produce a booklet.

- 1 To change the print settings from your software application, access the printer properties. See “Printing a Document” on page 12.
- 2 From the **Layout** tab, choose **Booklet Printing** from the **Layout Type** drop-down list.

NOTE: The **Booklet Printing** option is not available for all paper sizes. In order to find out the available paper size for this feature, select the paper size in the **Size** option on the **Paper** tab, then check if the **Booklet Printing** in a **Layout Type** drop-down list on the **Layout** tab is activated.

- 3 Click the **Paper** tab, and select the paper source, size, and type.
- 4 Click **OK** and print the document.
- 5 After printing, fold and staple the pages.

Printing on Both Sides of Paper

You can print on both sides of a sheet of paper. Before printing, decide how you want your document oriented.

The options are:

- **Printer Setting**, if you select this option, this feature is determined by the setting you've made on the control panel of the printer. *If this option does not appear, your printer does not have this feature.*
- **None**
- **Long Edge**, which is the conventional layout used in book binding.
- **Short Edge**, which is the type often used with calendars.

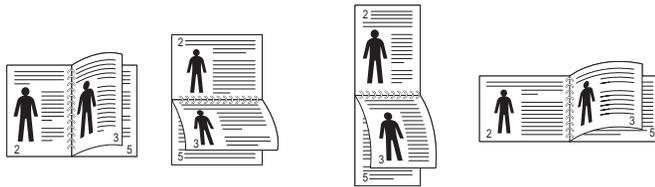

▲ Long Edge

▲ Short Edge

- **Reverse Duplex Printing**, allows you to select general print order compare to duplex print order. *If this option does not appear, your printer does not have this feature.*

NOTE:

- Do not print on both sides of labels, transparencies, envelopes, or thick paper. Paper jamming and damage to the printer may result.

- 1 To change the print settings from your software application, access printer properties. "Printing a Document" on page 12.
- 2 From the **Layout** tab, select the paper orientation.
- 3 From the **Double-sided Printing** section, select the binding option you want.
- 4 Click the **Paper** tab and select the paper source, size, and type.
- 5 Click **OK** and print the document.

NOTE: If your printer does not have a duplex unit, you should complete the printing job manually. The printer prints every other page of the document first. After printing the first side of your job, the Printing Tip window appears. Follow the on-screen instructions to complete the printing job.

Printing a Reduced or Enlarged Document

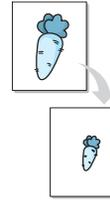

You can change the size of a page's content to appear larger or smaller on the printed page.

- 1 To change the print settings from your software application, access printer properties. See "Printing a Document" on page 12.
- 2 From the **Paper** tab, select **Reduce/Enlarge** in the **Printing Type** drop-down list.
- 3 Enter the scaling rate in the **Percentage** input box. You can also click the ▼ or ▲ button.
- 4 Select the paper source, size, and type in **Paper Options**.
- 5 Click **OK** and print the document.

Fitting Your Document to a Selected Paper Size

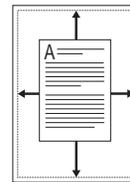

This printer feature allows you to scale your print job to any selected paper size regardless of the digital document size. This can be useful when you want to check fine details on a small document.

- 1 To change the print settings from your software application, access printer properties. See "Printing a Document" on page 12.
- 2 From the **Paper** tab, select **Fit to Page** in the **Printing Type** drop-down list.
- 3 Select the correct size from the **Output size** drop-down list.
- 4 Select the paper source, size, and type in **Paper Options**.
- 5 Click **OK** and print the document.

Using Watermarks

The Watermark option allows you to print text over an existing document. For example, you may want to have large gray letters reading "DRAFT" or "CONFIDENTIAL" printed diagonally across the first page or all pages of a document.

There are several predefined watermarks that come with the printer, and they can be modified, or you can add new ones to the list.

Using an Existing Watermark

- 1 To change the print settings from your software application, access printer properties. See "Printing a Document" on page 12.
- 2 Click the **Extras** tab, and select the desired watermark from the **Watermark** drop-down list. You will see the selected watermark in the preview image.
- 3 Click **OK** and start printing.

NOTE: The preview image shows how the page will look when it is printed.

Creating a Watermark

- 1 To change the print settings from your software application, access printer properties. See "Printing a Document" on page 12.
- 2 Click the **Extras** tab, and click the **Edit** button in the **Watermark** section. The **Edit Watermark** window appears.
- 3 Enter a text message in the **Watermark Message** box. You can enter up to 40 characters. The message displays in the preview window.
When the **First Page Only** box is checked, the watermark prints on the first page only.
- 4 Select watermark options.
You can select the font name, style, size, or grayscale level from the **Font Attributes** section and set the angle of the watermark from the **Message Angle** section.
- 5 Click **Add** to add a new watermark to the list.
- 6 When you have finished editing, click **OK** and start printing.

To stop printing the watermark, select **(No Watermark)** from the **Watermark** drop-down list.

Editing a Watermark

- 1 To change the print settings from your software application, access printer properties. See "Printing a Document" on page 12.
- 2 Click the **Extras** tab and click the **Edit** button in the **Watermark** section. The **Edit Watermark** window appears.
- 3 Select the watermark you want to edit from the **Current Watermarks** list and change the watermark message and options.
- 4 Click **Update** to save the changes.
- 5 Click **OK** until you exit the Print window.

Deleting a Watermark

- 1 To change the print settings from your software application, access printer properties. See "Printing a Document" on page 12.
- 2 From the **Extras** tab, click the **Edit** button in the Watermark section. The **Edit Watermark** window appears.
- 3 Select the watermark you want to delete from the **Current Watermarks** list and click **Delete**.
- 4 Click **OK** until you exit the Print window.

Using Overlays

What is an Overlay?



An overlay is text and/or images stored in the computer hard disk drive (HDD) as a special file format that can be printed on any document. Overlays are often used to take the place of preprinted forms and letterhead paper. Rather than using preprinted letterhead, you can create an overlay containing the exact same information that is currently on your letterhead. To print a letter with your company's letterhead, you do not need to load preprinted letterhead paper in the printer. You need only tell the printer to print the letterhead overlay on your document.

Creating a New Page Overlay



To use a page overlay, you must create a new page overlay containing your logo or image.

- 1 Create or open a document containing text or an image for use in a new page overlay. Position the items exactly as you wish them to appear when printed as an overlay.
- 2 To save the document as an overlay, access printer properties. See "Printing a Document" on page 12.
- 3 Click the **Extras** tab, and click **Edit** button in the **Overlay** section.
- 4 In the Edit Overlay window, click **Create Overlay**.
- 5 In the Create Overlay window, type a name of up to eight characters in the **File name** box. Select the destination path, if necessary. (The default is C:\Formover).
- 6 Click **Save**. The name appears on the **Overlay List** box.
- 7 Click **OK** or **Yes** to finish creating.
The file is not printed. Instead it is stored on your computer hard disk drive.

NOTE: The overlay document size must be the same as the documents you print with the overlay. Do not create an overlay with a watermark.

Using a Page Overlay

After an overlay has been created, it is ready to be printed with your document. To print an overlay with a document:

- 1 Create or open the document you want to print.
- 2 To change the print settings from your software application, access printer properties. See "Printing a Document" on page 12.
- 3 Click the **Extras** tab.
- 4 Select the desired overlay from the **Overlay** drop-down list box.
- 5 If the overlay file you want does not appear in the **Overlay** list, click **Edit** button and **Load Overlay**, and select the overlay file.

If you have stored the overlay file you want to use in an external source, you can also load the file when you access the **Load Overlay** window.

After you select the file, click **Open**. The file appears in the **Overlay List** box and is available for printing. Select the overlay from the **Overlay List** box.

- 6 If necessary, click **Confirm Page Overlay When Printing**. If this box is checked, a message window appears each time you submit a document for printing, asking you to confirm your wish to print an overlay on your document.
If this box is not checked and an overlay has been selected, the overlay automatically prints with your document.
- 7 Click **OK** or **Yes** until printing begins.
The selected overlay downloads with your print job and prints on your document.

NOTE: The resolution of the overlay document must be the same as that of the document you will print with the overlay.

Deleting a Page Overlay

You can delete page overlays that you no longer use.

- 1 In the printer properties window, click the **Extras** tab.
- 2 Click the **Edit** button in the **Overlay** section.
- 3 Select the overlay you want to delete from the **Overlay List** box.
- 4 Click **Delete Overlay**.
- 5 When a confirming message window appears, click **Yes**.
- 6 Click **OK** until you exit the Print window.

4 Using Windows PostScript Driver

If you want to use the PostScript driver provided with your system CD-ROM to print a document.

PPDs, in combination with the PostScript driver, access printer features and allow the computer to communicate with the printer. An installation program for the PPDs is provided on the supplied software CD-ROM.

Printer Settings

You can use the printer properties window, which allows you to access all of the printer options you need when using your printer. When the printer properties are displayed, you can review and change the settings needed for your print job.

Your printer properties window may differ, depending on your operating system. This Software User's Guide shows the Properties window for Windows XP.

Your printer driver **Properties** window that appears in this User's Guide may differ depending on the printer in use.

NOTES:

- Most Windows applications will override settings you specify in the printer driver. Change all print settings available in the software application first, and change any remaining settings using the printer driver.
 - The settings you change remain in effect only while you are using the current program. **To make your changes permanent**, make them in the Printers folder.
 - The following procedure is for Windows XP. For other Windows OS, refer to the corresponding Windows User's Guide or online help.
 1. Click the Windows **Start** button.
 2. Select **Printers and Faxes**.
 3. Select **your printer driver icon**.
 4. Right-click on the printer driver icon and select **Printing Preferences**.
 5. Change the settings on each tab, click OK.
-

Advanced

You can use advanced settings by clicking the **Advanced** button.

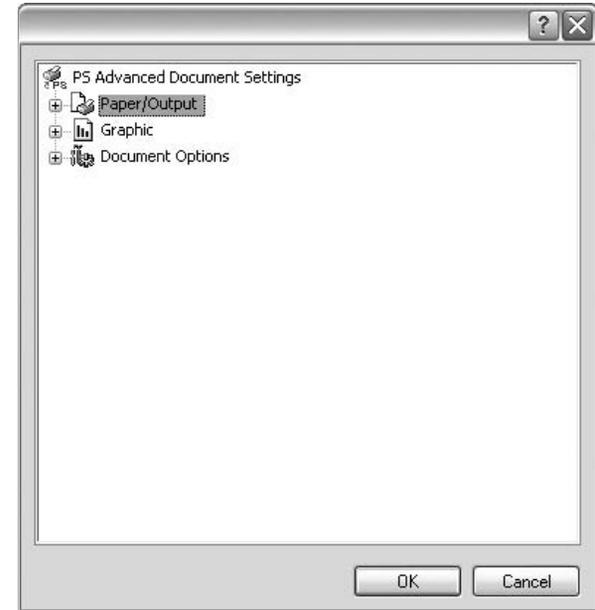

- **Paper/Output** this option allows you to select the size of the paper loaded in the tray.
- **Graphic** this option allows you to adjust the print quality for your specific printing needs.
- **Document Options** this options allow you to set the PostScript options or printer features.

Using Help

You can click  from the upper right corner of the window, and then click on any setting.

5 Sharing the Printer Locally

You can connect the printer directly to a selected computer, which is called “host computer,” on the network.

The following procedure is for Windows XP. For other Windows OS, refer to the corresponding Windows User's Guide or online help.

NOTES:

- Check the Operating System(s) that are compatible with your printer. Please refer to the OS Compatibility section of Printer Specifications in your Printer User's Guide.
 - If you need to know the exact name of your printer, you can check the supplied CD-ROM.
-

Setting Up a Host Computer

- 1 Start Windows.
- 2 From the **Start** menu select **Printers and Faxes**.
- 3 Double-click **your printer driver icon**.
- 4 From the **Printer** menu, select **Sharing**.
- 5 Check the **Share this printer** box.
- 6 Fill in the **Shared Name** field, and then click **OK**.

Setting Up a Client Computer

- 1 Right-click the Windows **Start** button and select **Explore**.
- 2 Select **My Network Places** and then right-click **Search for Computers**.
- 3 Fill in the IP address of host computer in **Computer name** field, and click **Search**. (In case host computer requires **User name** and **Password**, fill in User ID and password of host computer account.)
- 4 Double-click **Printers and Faxes**.
- 5 Right-click printer driver icon, select **Connect**.
- 6 Click **Yes**, if the installation confirm message appears.

6 Using Smart Panel

Smart Panel is a program that monitors and informs you of the status of the printer, and allows you to customize the printer's settings. If you are a Windows or Macintosh OS user, Smart Panel is installed automatically when you install the printer software. If you are a Linux OS user, download Smart Panel from the Samsung website (www.samsung.com/printer) and install.

NOTES:

- To use this program, you need:
 - To check for Operating System(s) that are compatible with your printer, refer to Printer Specifications in your Printer User's Guide.
 - Mac OS X 10.3 or higher
 - Linux. To check for Linux systems that are compatible with your printer, refer to Printer Specifications in your Printer User's Guide.
 - Internet Explorer version 5.0 or higher for flash animation in HTML Help.
- If you need to know the exact name of your printer, you can check the supplied CD-ROM.

Understanding Smart Panel

If an error occurs while printing, Smart Panel appears automatically, showing the error.

You can also launch Smart Panel manually. Double-click the Smart Panel icon on the Windows task bar (in Windows), or Notification Area (in Linux). You can also click it on the status bar (in Mac OS X).

Double-click this icon in Windows.



Click this icon in Mac OS X.



Click this icon in Linux.



If you are a Windows user, from the **Start** menu, select **Programs** or **All Programs** → **your printer driver name** → **Smart Panel**.

NOTES:

- If you have already installed more than one Samsung printer, first select the printer model you want in order to use the corresponding Smart Panel. Right-click (in Windows or Linux) or click (in Mac OS X) the Smart Panel icon and select **your printer name**.
- The Smart Panel window and its contents shown in this Software User's Guide may differ depending on the printer or Operating System in use.

The Smart Panel program displays the current status of the printer, the level of toner remaining in the toner cartridge(s) and various other information. You can also change settings.



1 Toner Level

You can view the level of toner remaining in the toner cartridge(s). The printer and the number of toner cartridge(s) shown in the above window may differ depending on the printer in use. Any printers do not have this feature.

Buy Now

You can order replacement toner cartridge(s) online.

Troubleshooting Guide

You can view Help to solve problems.

Printer Setting

You can configure various printer settings in the Printer Settings Utility window. Any printers do not have this feature.

NOTE: If your printer is connected to a network and you are a Windows and Mac OS X user, the **SyncThru Web Service**

window appears instead of the Printer Settings Utility window. Linux does not support network environments.

Driver Setting (Only for Windows)

You can use the printer properties window, which allows you to access all of the printer options you need for using your printer. For details, See “Printer Settings” on page 13.

Opening the Troubleshooting Guide

Using the troubleshooting guide, you can view solutions for error status problems.

Right-click (in Windows or Linux) or click (in Mac OS X) the Smart Panel icon and select **Troubleshooting Guide**.

Using Printer Settings Utility

Using the Printer Settings Utility, you can configure and check print settings.

- 1 Right-click (in Windows or Linux) or click (in Mac OS X) the Smart Panel icon and select **Printer Setting**.
- 2 Change the settings.
- 3 To send the changes to the printer, click the **Apply** button.

NOTES: If your printer is connected to a network, the **SyncThru Web Service** window appears instead of the Printer Settings Utility window.

Using Onscreen Help File

For more information about **Printer Settings Utility**, click  .

Changing the Smart Panel Program Settings

Right-click (in Windows or Linux) or click (in Mac OS X) the Smart Panel icon and select **Options**.

Select the settings you want from the **Options** window.

7 Using Your Printer in Linux

You can use your machine in a Linux environment.

This chapter includes:

- **Getting Started**
- **Installing the Unified Linux Driver**
- **Using the Unified Driver Configurator**
- **Configuring Printer Properties**
- **Printing a Document**

Getting Started

You need to download Linux software package from the Samsung website (www.samsung.com/printer) to install the printer softwares.

After the driver is installed on your Linux system, the driver package allows you to monitor a number of machine devices via fast ECP parallel ports and USB simultaneously.

The Unified Linux Driver package is supplied with a smart and flexible installation program. You don't need to search for additional components that might be necessary for the Unified Linux Driver software: all required packages will be carried onto your system and installed automatically; this is possible on a wide set of the most popular Linux clones.

Installing the Unified Linux Driver

Installing the Unified Linux Driver

- 1 Make sure that you connect your machine to your computer. Turn both the computer and the machine on.
- 2 When the Administrator Login window appears, type in *root* in the Login field and enter the system password.

NOTE: You must log in as a super user (*root*) to install the printer software. If you are not a super user, ask your system administrator.

- 3 From the Samsung website, download and unpack the Unified Linux Driver package to your computer.
- 4 Click the  icon at the bottom of the desktop. When the Terminal screen appears, type in:

```
[root@localhost root]#tar zxf [FilePath]/
UnifiedLinuxDriver.tar.gz[root@localhost root]#cd
[FilePath]/cdroot/Linux[root@localhost Linux]#./
install.sh
```

NOTE: If you do not use the graphical interface and failed to install the software, you have to use the driver in the text mode. Follow the steps 3 to 4, and then follow the instructions on the terminal screen.

- 5 When the welcome screen appears, click **Next**.



- 6 When the installation is complete, click **Finish**.



The installation program has added the Unified Driver Configurator desktop icon and Samsung Unified Driver group to the system menu for your convenience. If you have any difficulties, consult the onscreen help that is available through your system menu or can otherwise be called from the driver package windows applications, such as **Unified Driver Configurator**.

Uninstalling the Unified Linux Driver

- 1 When the Administrator Login window appears, type in *root* in the Login field and enter the system password.

NOTE: You must log in as a super user (*root*) to install the printer software. If you are not a super user, ask your system administrator.

- 2 Click the  icon at the bottom of the desktop. When the Terminal screen appears, type in:

```
[root@localhost root]#cd /opt/Samsung/mfp/uninstall/  
[root@localhost uninstall]#./uninstall.sh
```
- 3 Click **Uninstall**.
- 4 Click **Next**.

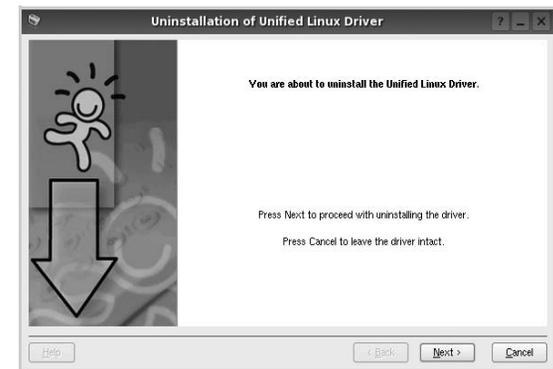

- 5 Click **Finish**.

Using the Unified Driver Configurator

Unified Linux Driver Configurator is a tool primarily intended for configuring Printer.

After installing the Unified Linux driver, the Unified Linux Driver Configurator icon will automatically be created on your desktop.

Opening the Unified Driver Configurator

- 1 Double-click **Unified Driver Configurator** on the desktop.
You can also click the Startup Menu icon and select **Samsung Unified Driver** and then **Unified Driver Configurator**.
- 2 Press each button on the Modules pane to switch to the corresponding configuration window.

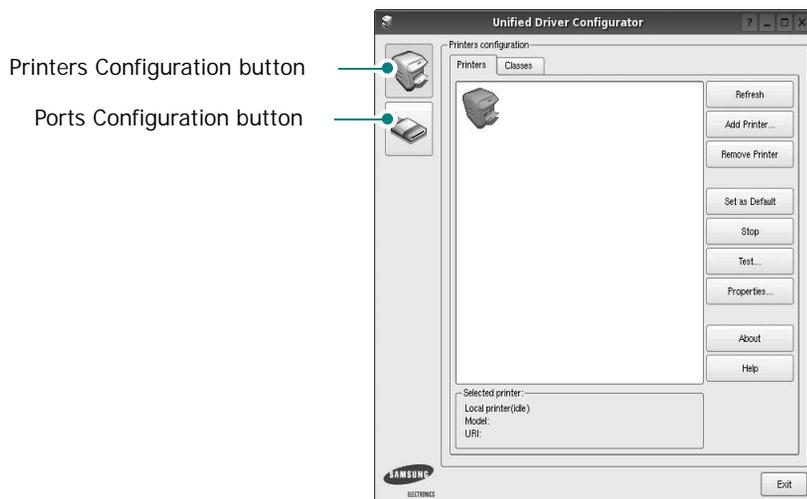

- 3 You can use the onscreen help by clicking **Help**.
After changing the configurations, click **Exit** to close the Unified Driver Configurator.

Printers Configuration

Printers configuration has the two tabs: **Printers** and **Classes**.

Printers Tab

You can see the current system's printer configuration by clicking on the printer icon button on the left side of the Unified Driver Configurator window.

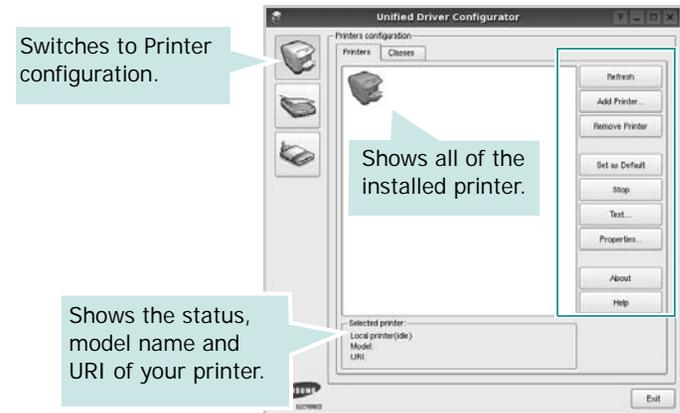

You can use the following printer control buttons:

- **Refresh:** renews the available printers list.
- **Add Printer:** allows you to add a new printer.
- **Remove Printer:** removes the selected printer.
- **Set as Default:** sets the current printer as a default printer.
- **Stop/Start:** stops/starts the printer.
- **Test:** allows you to print a test page to check if the machine is working properly.
- **Properties:** allows you to view and change the printer properties. For details, see page 30.

Classes Tab

The Classes tab shows a list of available printer classes.

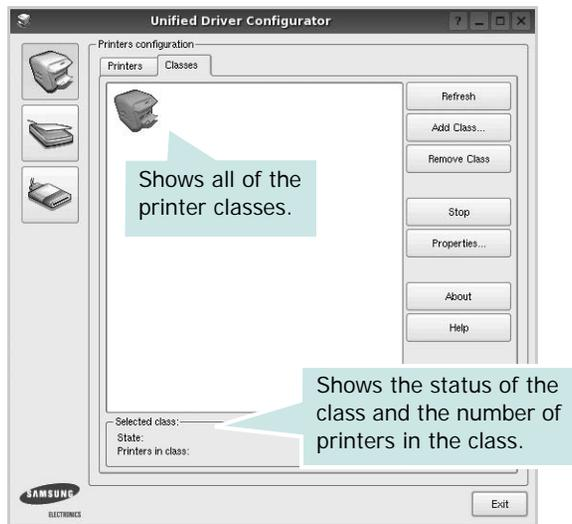

- **Refresh** : Renews the classes list.
- **Add Class...** : Allows you to add a new printer class.
- **Remove Class** : Removes the selected printer class.

Ports Configuration

In this window, you can view the list of available ports, check the status of each port and release a port that is stalled in busy state when its owner is terminated for any reason.

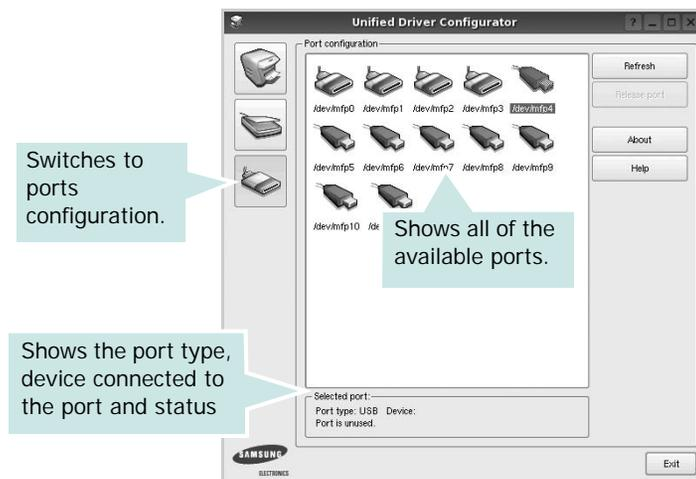

- **Refresh** : Renews the available ports list.
- **Release port** : Releases the selected port.

Configuring Printer Properties

Using the properties window provided by the Printers configuration, you can change the various properties for your machine as a printer.

- 1 Open the Unified Driver Configurator.
If necessary, switch to Printers configuration.
- 2 Select your machine on the available printers list and click **Properties**.
- 3 The Printer Properties window opens.

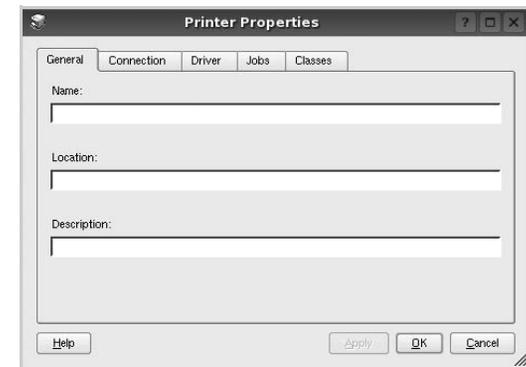

The following five tabs display at the top of the window:

- **General**: allows you to change the printer location and name. The name entered in this tab displays on the printer list in Printers configuration.
 - **Connection**: allows you to view or select another port. If you change the printer port from USB to parallel or vice versa while in use, you must re-configure the printer port in this tab.
 - **Driver**: allows you to view or select another printer driver. By clicking **Options**, you can set the default device options.
 - **Jobs**: shows the list of print jobs. Click **Cancel job** to cancel the selected job and select the **Show completed jobs** check box to see previous jobs on the job list.
 - **Classes**: shows the class that your printer is in. Click **Add to Class** to add your printer to a specific class or click **Remove from Class** to remove the printer from the selected class.
- 4 Click **OK** to apply the changes and close the Printer Properties Window.

Printing a Document

Printing from Applications

There are a lot of Linux applications that you are allowed to print from using Common UNIX Printing System (CUPS). You can print on your machine from any such application.

- 1 From the application you are using, select **Print** from the **File** menu.
- 2 Select **Print** directly using **lpr**.
- 3 In the LPR GUI window, select the model name of your machine from the Printer list and click **Properties**.

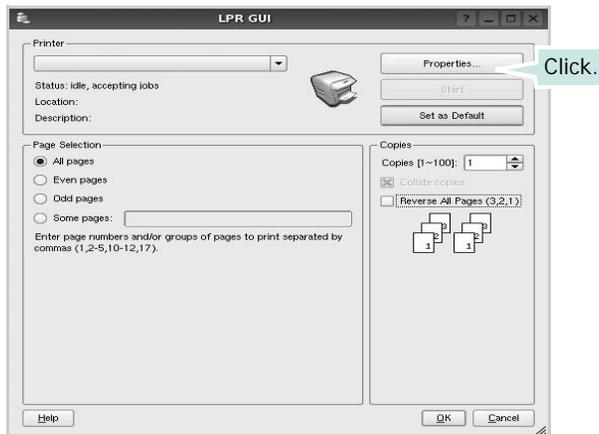

- 4 Change the printer and print job properties.

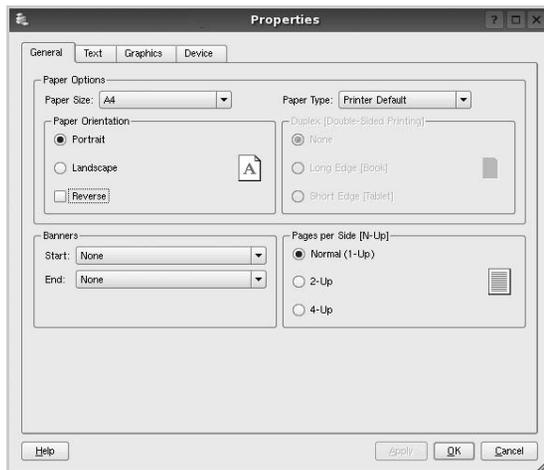

The following four tabs display at the top of the window.

- **General** - allows you to change the paper size, the paper type, and the orientation of the documents, enables the duplex feature, adds start and end banners, and changes the number of pages per sheet.
 - **Text** - allows you to specify the page margins and set the text options, such as spacing or columns.
 - **Graphics** - allows you to set image options that are used when printing images/files, such as color options, image size, or image position.
 - **Device**: allows you to set the print resolution, paper source, and destination.
- 5 Click **Apply** to apply the changes and close the Properties window.
 - 6 Click **OK** in the LPR GUI window to start printing.
 - 7 The Printing window appears, allowing you to monitor the status of your print job.

To abort the current job, click **Cancel**.

Printing Files

You can print many different types of files on the Samsung machine device using the standard CUPS way - directly from the command line interface. The CUPS `lpr` utility allows you to do that. But the drivers package replaces the standard `lpr` tool by a much more user-friendly LPR GUI program.

To print any document file:

- 1 Type `lpr <file_name>` from the Linux shell command line and press **Enter**. The LPR GUI window appears.
When you type only `lpr` and press **Enter**, the Select file(s) to print window appears first. Just select any files you want to print and click **Open**.
- 2 In the LPR GUI window, select your printer from the list, and change the printer and print job properties.
For details about the properties window, see page 31.
- 3 Click **OK** to start printing.

8 Using Your Printer with a Macintosh

Your machine supports Macintosh systems with a built-in USB interface or a 10/100 Base-TX network interface card. When you print a file from a Macintosh computer, you can use the PostScript driver by installing the PPD file.

NOTE: *Some printers do not support a network interface. Make sure that your printer supports a network interface by referring to Printer Specifications in your Printer User's Guide.*

This chapter includes:

- **Installing Software**
- **Setting Up the Printer**
- **Printing**

Installing Software

The PostScript driver CD-ROM that came with your machine provides you with the PPD file to use the PS driver, Apple LaserWriter driver, for printing on a Macintosh computer.

Printer driver

Installing the printer driver

- 1 Connect your machine to the computer using the USB cable or the Ethernet cable.
- 2 Turn on your computer and the machine.
- 3 Insert the PostScript driver CD-ROM which came with your machine into the CD-ROM drive.
- 4 Double-click the **Samsung_LBP** on your Macintosh desktop.
- 5 Double-click the **MAC_Installer** folder.
- 6 Double-click the **MAC_Printer** folder.
- 7 For Mac OS 8.6~9.2, double-click the **Samsung_LBP Installer Classic** icon.
For Mac OS 10.1 or higher, double-click the **Samsung_LBP Installer OSX** icon.
- 8 Click **Continue**.
- 9 Click **Install**.
- 10 After the installation is finished, click **Quit**.

Uninstalling the printer driver

- 1 Insert the CD-ROM which came with your printer into the CD-ROM drive.
- 2 Double-click **CD-ROM icon** that appears on your Macintosh desktop.
- 3 Double-click the **Samsung_LBP** on your Macintosh desktop.
- 4 Double-click the **MAC_Installer** folder.
- 5 Double-click the **MAC_Printer** folder.
- 6 For Mac OS 8.6~9.2, double-click the **Samsung_LBP Installer Classic** icon.
For Mac OS 10.1 or higher, double-click the **Samsung_LBP Installer OSX** icon.
- 7 Select **Uninstall** and then click **Uninstall**.
- 8 Click **Continue**.
- 9 When the uninstallation is done, click **Quit**.

Setting Up the Printer

Set up for your printer will be different depending on which cable you use to connect the printer to your computer—the network cable or the USB cable.

For a Network-connected

NOTE: *Some printers do not support a network interface. Before connecting your printer, make sure that your printer supports a network interface by referring to Printer Specifications in your Printer User's Guide.*

Mac OS 8.6 ~ 9.2

- 1 Follow the instructions on “Installing Software” on page 32 to install the PPD file on your computer.
- 2 From the **Apple** menu, select **Chooser**.
- 3 Click **LaserWriter 8** (the PostScript driver provided with your Macintosh).
The name of your machine appears on the list.
- 4 Select **SEC000xxxxxxxxx** from the printer box (where the xxxxxxxxx varies depending on each of the machines) and Click **Select**.
If Auto Setup does not work properly, click **Select PPD**, choose **your printer name**, and click **OK**.
- 5 When the setup is complete, you see your machine icon created as a desktop printer.
- 6 Close the **Chooser**.
- 7 When a message window appears telling you that you have changed your current machine, click **OK**.

Mac OS 10.1 or higher

- 1 Follow the instructions on “Installing Software” on page 32 to install the PPD file on your computer.
- 2 Open the **Applications** folder → **Utilities**, and **Print Setup Utility**.
 - For MAC OS 10.5~10.6, open **System Preferences** from the **Applications** folder, and click **Printer & Fax**.
- 3 Click **Add** on the **Printer List**.
 - For MAC OS 10.5~10.6, press the “+” icon then a display window will pop up.
- 4 Select the **AppleTalk** tab.
 - For MAC OS 10.3, select the **Rendezvous** tab.
 - For MAC OS 10.4, click **Default Browser** and find the **Bonjour**.

- For MAC OS 10.5~10.6, click **Default** and find the **Bonjour**.

The name of your machine appears on the list. Select **SEC000xxxxxxxxx** from the printer box, where the xxxxxxxxx varies depending on your machine.

- 5 If Auto Select does not work properly, select **Samsung** in **Printer Model** and **your printer name** in **Model Name**. Your machine appears on the Printer List and is set as the default printer.
 - For MAC OS 10.5~10.6, if Auto Select does not work properly, select **Select a driver to use...** and **your printer name** in **Print Using**.
- 6 Click **Add**.

For a USB-connected

Mac OS 10.1 or higher

- 1 Follow the instructions on “Installing Software” on page 32 to install the PPD file on your computer.
- 2 Open the **Applications** folder → **Utilities**, and **Print Setup Utility**.
 - For MAC OS 10.5~10.6, open **System Preferences** from the **Applications** folder, and click **Printer & Fax**.
- 3 Click **Add** on the **Printer List**.
 - For MAC OS 10.5~10.6, press the “+” icon then a display window will pop up.
- 4 Select the **USB** tab.
 - For MAC OS 10.4, click **Default Browser** and find the USB connection.
 - For MAC OS 10.5~10.6, click **Default** and find the USB connection.
- 5 Select **your printer name** and click **Add**.
- 6 If Auto Select does not work properly, select **Samsung** in **Printer Model** and **your printer name** in **Model Name**. Your machine appears on the Printer List and is set as the default printer.
 - For MAC OS 10.5~10.6, if Auto Select does not work properly, select **Select a driver to use...** and **your printer name** in **Print Using**.
- 7 Click **Add**.

Printing

NOTES:

- The Macintosh printer's properties window that appears in this User's Guide may differ depending on the printer in use. However the composition of the printer properties window is similar.
- *You can check your printer name in the supplied CD-ROM.*

Printing a Document

When you print with a Macintosh, you need to check the printer software setting in each application you use. Follow these steps to print from a Macintosh.

- 1 Open a Macintosh application and select the file you want to print.
- 2 Open the **File** menu and click **Page Setup (Document Setup** in some applications).
- 3 Choose your paper size, orientation, scaling, and other options and click **OK**.

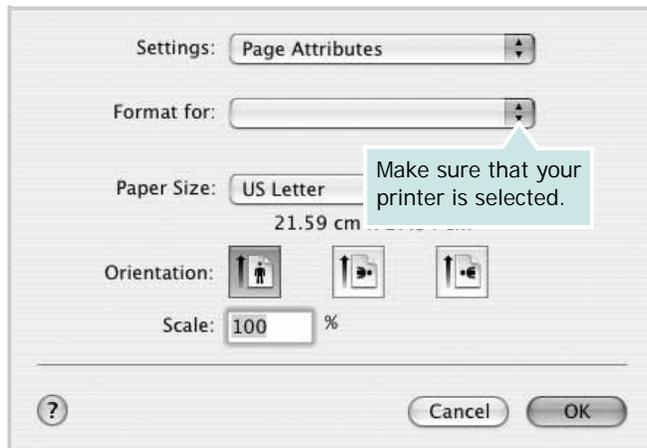

- 4 Open the **File** menu and click **Print**.
- 5 Choose the number of copies you want and indicate which pages you want to print.
- 6 Click **Print** when you finish setting the options.

Changing Printer Settings

You can use advanced printing features when using your printer.

From your Macintosh application, select **Print** from the **File** menu. The printer name which appears in the printer properties window may differ depending on the printer in use. Except for the name, the composition of the printer properties window is similar.

NOTE: The setting options may differ depending on printers and Macintosh OS version.

Layout

The **Layout** tab provides options to adjust how the document appears on the printed page. You can print multiple pages on one sheet of paper. Select **Layout** from the **Presets** drop-down list to access the following features.

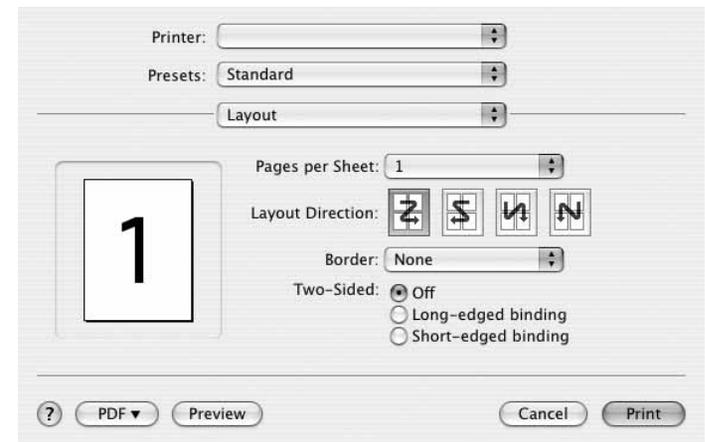

- **Pages per Sheet:** This feature determines how many pages printed on one page. For details, see "Printing Multiple Pages on One Sheet of Paper" on the next column.
- **Layout Direction:** You can select the printing direction on a page as like the examples on UI.

Graphics

The **Graphics** tab provides options for selecting **Resolution(Quality)**. Select **Graphics** from the **Presets'** drop-down list to access the graphic features.

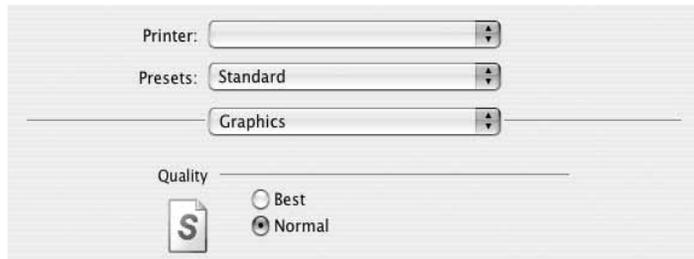

- **Resolution(Quality)**: You can select the printing resolution. The higher the setting, the sharper the clarity of printed characters and graphics. The higher setting also may increase the time it takes to print a document.

Paper

Set **Paper Type** to correspond to the paper loaded in the tray from which you want to print. This will let you get the best quality printout. If you load a different type of print material, select the corresponding paper type.



Printer Features

This tab provides options for selecting the paper type and adjusting print quality. Select **Printer Features** from the **Presets'** drop-down list to access the following features:



- **Reverse Duplex Printing**: Allows you to select general print order compare to duplex print order.
- **Fit to Page**: This setting allows you to scale your print job to any selected paper size regardless of the digital document size. This can be useful when you want to check fine details on a small document.
- **Image Mode**: mage Mode allows the user to enhance printouts. The available options are Normal and Text Enhance.

Printing Multiple Pages on One Sheet of Paper

You can print more than one page on a single sheet of paper. This feature provides a cost-effective way to print draft pages.

- 1 From your Macintosh application, select **Print** from the **File** menu.
- 2 Select **Layout**.

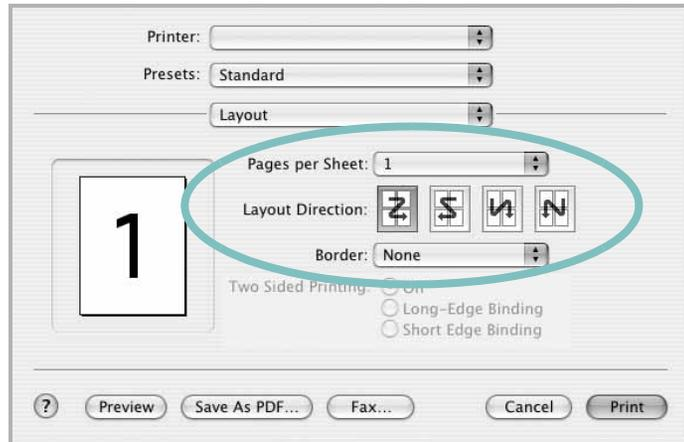

- 3 Select the number of pages you want to print on one sheet of paper on the **Pages per Sheet** drop-down list.
- 4 Select the page order from the **Layout Direction** option. To print a border around each page on the sheet, select the option you want from the **Border** drop-down list.
- 5 Click **Print**, and the printer prints the selected number of pages on one side of each page.

Duplex Printing

You can print on both sides of the paper. Before printing in the duplex mode, decide on which edge you will be binding your finished document. The binding options are:

Long-Edge Binding: Which is the conventional layout used in book binding.

Short-Edge Binding: Which is the type often used with calendars.

- 1 From your Macintosh application, select **Print** from the **File** menu.
- 2 Select the **Layout**.

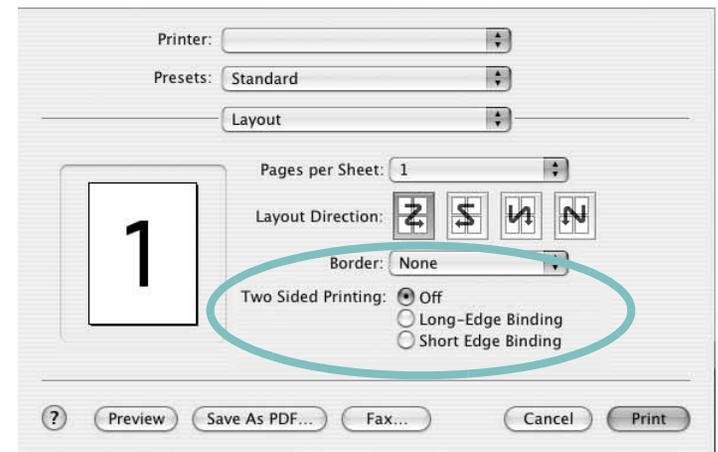

- 3 Select a binding orientation from **Two Sided Printing** option.
- 4 Click **Print** and the printer prints on both sides of the paper.

CAUTION: If you have selected duplex printing and then try to print multiple copies of a document, the printer may not print the document in the way you want. In case of "Collated copy", if your document has odd pages, the last page of the first copy and the first page of the next copy will be printed on the front and back of one sheet. In case of "Uncollated copy", the same page will be printed on the front and back of one sheet. Therefore, if you need multiple copies of a document and you want those copies on both sides of the paper, you must print them one at a time, as separate print jobs.

SOFTWARE SECTION

INDEX

A

advanced printing, use 18

B

booklet printing 19

D

document, print

Macintosh 34

Windows 12

double-sided printing 20

driver, install

Linux 27

E

Extras properties, set 16

F

favorites settings, use 17

G

Graphics properties, set 15

H

help, use 17, 23

I

install

printer driver

Macintosh 32

Windows 4

installing

Linux software 27

L

language, change 10

Layout properties, set

Windows 14

Linux

driver, install 27

printer properties 30

printing 31

M

Macintosh

driver

install 32

printing 34

setting up the printer 33

N

n-up printing

Macintosh 36

Windows 18

O

orientation, print 31

Windows 14

overlay

create 22

delete 22

print 22

P

Paper properties, set 14

paper size, set 14

print 31

paper source, set 31

Windows 15

paper type, set

Macintosh 35

print 31

poster, print 19

PostScript driver

installing 23

print

document 12

fit to page 20

from Macintosh 34

from Windows 12

N-up

Macintosh 36

Windows 18

overlay 22

poster 21

PRN 13

scaling 20

watermark 21

print resolution 31

printer driver, install

Linux 27

printer properties

Linux 31

printer properties, set

Macintosh 34

Windows 13, 23

printer resolution, set

Windows 15

printer software

install

Macintosh 32

Windows 4

uninstall

Windows 11

printing

booklets 19

double-sided 20

from Linux 31

R

resolution

printing 31

S

setting

darkness 15

- favorites 17
- image mode 15
- resolution
 - Windows 15
- toner save 15
- true-type option 15
- software
 - install
 - Macintosh 32
 - Windows 4
 - reinstall
 - Windows 10
 - system requirements
 - Macintosh 32
 - uninstall
 - Windows 11
- status monitor, use 25

T

- toner save, set 15

U

- uninstall, software
 - Windows 11
- uninstalling
 - driver
 - Linux 28

W

- watermark
 - create 21
 - delete 21
 - edit 21
 - print 21

www.samsungprinter.com