

SAMSUNG

SAMSUNG LASER PRINTER
User's Guide

ML-1750 Series



For UK customers:

To reorder your consumables

Call 0800 3164060

For Technical Assistance

Call 0870 2420303

This manual is provided for information purposes only. All information included herein is subject to change without notice. Samsung Electronics is not responsible for any damages, direct or indirect, arising from or related to use of this manual.

© 2003 Samsung Electronics Co., Ltd. All rights reserved.

- ML-1750, ML-1755 and Samsung logo are trademarks of Samsung Electronics Co., Ltd.
- PCL and PCL 6 are trademarks of Hewlett-Packard Company.
- Centronics is a trademark of Centronics Data Computer Corporation.
- IBM and IBM PC are trademarks of International Business Machines Corporation.
- Microsoft, Windows, Windows 9x, Windows Me, Windows 2000, Windows NT and Windows XP are registered trademarks of Microsoft Corporation.
- All other brand or product names are trademarks of their respective companies or organizations.

CONTENTS

Chapter 1: **INTRODUCTION**

Special Features	1.2
Printer Components	1.4
Front View	1.4
Inside View	1.5
Rear View	1.5
Understanding the Control Panel	1.6
On Line/Error and Toner Save LEDs	1.6
Cancel button	1.7

Chapter 2: **SETTING UP YOUR PRINTER**

Unpacking	2.2
Selecting a Location	2.3
Installing the Toner Cartridge	2.4
Loading Paper	2.6
Changing the Paper Size in the Tray	2.8
Connecting a Printer Cable	2.9
Turning the Printer on	2.11
Printing a Demo Page	2.12
Installing Printer Software	2.13
Printer Driver Features	2.14
Installing Printer software in Windows	2.15
Installing the USB Driver in Windows 98/Me	2.18

Chapter 3: USING PRINT MATERIALS

Choosing Paper and Other Materials	3.2
Sizes and Capacities	3.3
Guidelines for Paper and Special Materials	3.4
Selecting the Output Location	3.5
Printing to the Top Output Tray (Face down)	3.5
Printing to the Rear Output Tray (Face up)	3.6
Loading Paper	3.7
Using the Tray	3.7
Using the Manual Feeder	3.8
Printing on Envelopes	3.10
Printing on Labels	3.12
Printing on Transparencies	3.13
Printing on Card Stock or Custom-sized Materials	3.15
Printing on Preprinted Paper	3.16

Chapter 4: PRINTING TASKS

Printing a Document	4.2
Canceling a Print Job	4.4
Using a Favorite Setting	4.5
Using Help	4.5
Setting Paper Properties	4.6
Using the Toner Save Mode	4.8
Printing Multiple Pages on One Sheet of Paper (N-Up Printing)	4.10
Scaling Your Document	4.12
Fitting Your Document to a Selected Paper Size	4.13
Printing Posters	4.14
Setting Graphic Properties	4.16
Printing Watermarks	4.19
Using an existing Watermark	4.19
Creating a Watermark	4.20
Editing a Watermark	4.21
Deleting a Watermark	4.21
Printing Overlays	4.22
What is an Overlay?	4.22
Creating a New Page Overlay	4.22
Using a Page Overlay	4.24
Deleting a Page Overlay	4.25
Using the Status Monitor	4.26
Opening the Status Monitor	4.26
Setting Up Locally Shared Printer	4.28
Windows 9x/Me	4.28
Windows NT/2000/XP	4.29

Chapter 5: MAINTAINING YOUR PRINTER

Maintaining the Toner Cartridge	5.2
Redistributing Toner	5.3
Replacing the Toner Cartridge	5.4
Cleaning the Printer	5.5
Cleaning the Outside	5.5
Cleaning the Inside	5.5
Consumables and Replacement Parts	5.8

Chapter 6: SOLVING PROBLEMS

Troubleshooting Checklist	6.2
Solving General Printing Problems	6.3
Clearing Paper Jams	6.7
In the Paper Exit Area	6.7
In the Paper Feed Area	6.9
Around the Toner Cartridge	6.10
Tips for Avoiding Paper Jams When Printing on the A5-sized Paper	6.11
Tips for Avoiding Paper Jams	6.12
Solving Print Quality Problems	6.12
Print Quality Checklist	6.12
Solving Print Quality Problems	6.13
Troubleshooting Error Messages	6.18
Common Windows Problems	6.19
Common Linux Problems	6.20
Common DOS problem	6.23

Chapter 7: APPENDIX

Using Your Printer in Linux	7.2
Installing the Printer Driver	7.2
Changing the Printer Connection Method	7.6
Using the Configuration Tool	7.8
Changing LLPR Properties	7.10
Printing from DOS Applications	7.12
About the Remote Control Panel	7.12
Installing the Remote Control Panel	7.12
Selecting Print Settings	7.14
Printer Specifications	7.21
Paper Specifications	7.22
Overview	7.22
Supported Sizes of Paper	7.23

Guidelines for Using Paper	7.24
Paper Specifications	7.25
Paper Output Capacity	7.25
Printer and Paper Storage Environment	7.26

Environmental and Safety Consideration

Laser Safety Statement

The printer is certified in the U.S. to conform to the requirements of DHHS 21 CFR, chapter 1 Subchapter J for Class I(1) laser products, and elsewhere, is certified as a Class I laser product conforming to the requirements of IEC 825.

Class I laser products are not considered to be hazardous. The laser system and printer are designed so there is never any human access to laser radiation above a Class I level during normal operation, user maintenance, or prescribed service condition.

WARNING

Never operate or service the printer with the protective cover removed from Laser/Scanner assembly. The reflected beam, although invisible, can damage your eyes. When using this product, these basic safety precautions should always be followed to reduce risk of fire, electric shock, and injury to persons:



CAUTION - INVISIBLE LASER RADIATION
WHEN THIS COVER OPEN.
DO NOT OPEN THIS COVER.

VORSICHT - UNSICHTBARE LASERSTRAHLUNG,
WENN ABDECKUNG GEÖFFNET.
NICHT DEM STRAHL AUSSETZEN.

ATTENTION - RAYONNEMENT LASER INVISIBLE EN CAS
D'OUVERTURE. EXPOSITION DANGEREUSE
AU FAISCEAU.

ATTENZIONE - RADIAZIONE LASER INVISIBILE IN CASO DI
APERTURA. EVITARE L'ESPOSIZIONE AL FASCIO.

PRECAUCIÓN - RADIACIÓN LASER INVISIBLE CUANDO SE ABRE.
EVITAR EXPONERSE AL RAYO.

PERIGO - RADIAÇÃO LASER INVISÍVEL AO ABRIR. EVITE
EXPOSIÇÃO DIRECTA AO FEIXE.

GEVAAR - ONZICHTBARE LASERSTRALEN BIJ GEOPENDE
KLEP. DEZE KLEP NIET OPENEN.

ADVARSEL - USYNLIG LASERSTRÅLNING VED ÅBNING, NÅR
SIKKERHEDSBRYDERE ER UDE AF FUNKTION.
UNDGÅ UDSAETTELSE FOR STRÅLNING.

ADVARSEL - USYNLIG LASERSTRÅLNING NÅR DEKSEL
ÅPNES. STIRR IKKE INN I STRÅLEN. UNNGÅ
EKSPONERING FOR STRÅLEN.

VARNING - OSYNLIG LASERSTRÅLNING NÅR DENNA DEL
ÄR ÖPPEN OCH SPÄRREN ÄR URKOPPLAD.
BETRAKTA EJ STRÅLEN. STRÅLEN ÄR FARLIG.

VARO! - AVATTAESSA JA SUOJALUKITUS OHITETTAESSA
OLET ALTTIINA NÄKYMÄTTÖMÄLLE LASER-
SÄTEILYLLE ÄLÄ KATSO SÄTEESEEN.

注 意 - 严禁揭开此盖, 以免激光泄露灼伤

주 의 - 이 덮개를 열면 레이저광에 노출될 수 있으므로
주의하십시오.

Ozone Safety



During normal operation, this machine produces ozone. The ozone produced does not present a hazard to the operator. However, it is advisable that the machine be operated in a well ventilated area.

If you need additional information about ozone, please contact your nearest Samsung dealer.

Power Saver



This printer contains advanced energy conservation technology that reduces power consumption when it is not in active use.

When the printer does not receive data for an extended period of time, power consumption is automatically lowered.

The energy star emblem does not represent EPA endorsement of any product or service.

Radio Frequency Emissions

FCC regulations

This device has been tested and found to comply with the limits for a Class B digital device, pursuant to Part 15 of the FCC rules. These limits are designed to provide reasonable protection against harmful interference in a residential installation. This equipment generates, uses and can radiate radio frequency energy and, if not installed and used in accordance with the instructions, may cause harmful interference to radio communications. However, there is no guarantee that interference will not occur in a particular installation. If this equipment does cause harmful interference to radio or television reception, which can be determined by turning the equipment off and on, the user is encouraged to try to correct the interference by one or more of the following measures:

- 1 Reposition the receiving antenna.
- 2 Increase the separation between the equipment and receiver.
- 3 Connect the equipment into an outlet on a circuit different from that to which the receiver is connected.
- 4 Consult the dealer or an experienced radio/TV technician for help.

CAUTION: Changes or modifications not expressly approved by the manufacturer responsible for compliance could void the user's authority to operate the equipment.

Canadian Radio Interference Regulations

This digital apparatus does not exceed the Class B limits for radio noise emissions from digital apparatus as set out in the interference-causing equipment standard entitled "Digital Apparatus", ICES-003 of the Industry and Science Canada.

Cet appareil numérique respecte les limites de bruits radioélectriques applicables aux appareils numériques de Classe B prescrites dans la norme sur le matériel brouilleur: "Appareils Numériques", ICES-003 édictée par l'Industrie et Sciences Canada.

Declaration of Conformity (European Countries)

Approvals and Certifications



The CE marking applied to this product symbolizes Samsung Electronics Co., Ltd. Declaration of Conformity with the following applicable 93/68/EEC Directives of the European Union as of the dates indicated:

January 1, 1995: Council Directive 73/23/EEC Approximation of the laws of the member states related to low voltage equipment.

January 1, 1996: Council Directive 89/336/EEC (92/31/EEC), approximation of the laws of the Member States related to electromagnetic compatibility.

March 9, 1999: Council Directive 1999/5/EC on radio equipment and telecommunications terminal equipment and the mutual recognition of their conformity.

A full declaration, defining the relevant Directives and referenced standards can be obtained from your Samsung Electronics Co., Ltd. representative.

EC Certification

Certification to 1999/5/EC Radio Equipment & Telecommunications Terminal Equipment Directive (FAX)

This Samsung product has been self-certified by Samsung for pan-European single terminal connection to the analogue public switched telephone network (PSTN) in accordance with Directive 1999/5/EC. The product has been designed to work with the national PSTNs and compatible PBXs of the European countries:

In the event of problems, you should contact the Euro QA Lab of Samsung Electronics Co., Ltd. in the first instance.

The product has been tested against TBR21 and/or TBR 38. To assist in the use and application of terminal equipment which complies with this standard, the European Telecommunication Standards Institute (ETSI) has issued an advisory document (EG 201 121) which contains notes and additional requirements to ensure network compatibility of TBR21 terminals. The product has been designed against, and is fully compliant with, all of the relevant advisory notes contained in this document.

EU Declaration of Conformity (LVD,EMC)

For the following product :

Laser Beam Printer

(Product name)

ML-1750, Phaser 3130

(Model Number)

Manufactured at :

Samsung Electronics Co.,Ltd #259. GongDan-Dong,Gumi-Shi, GyungBuk, KOREA 730-030

Shandong Samsung Telecommunications Co., Ltd. Sanxing Road, Weihai Hi-Tech, IDZ Shandong Province, 264 209, China

(factory name, address)

We hereby declare, that all major safety requirements, concerning to CE Marking Directive[93/68/EEC] and Low Voltage Directive [73/23/EEC], ElectroMagnetic Compatibility [89/336/EEC], amendments [92/31/EEC] are fulfilled, as laid out in the guideline set down by the member states of the EEC Commission.

This declaration is valid for all samples that are part of this declaration, which are manufactured according to the production charts appendix.

The standards relevant for the evaluation of safety & EMC requirements are as

LVD : EN 60950:2000, EN 60825-1:1994,A11:1996

EMC : EN 55022:1998, EN 61000-3-2:1995 inc+A1+A2:1998+A14:2000

EN61000-3-3:1995,EN 55024:1998

follows :

1. Certificate of conformity / Test report issued by :

LVD : TUV Rheinland

EMC : SAMSUNG Electronics EURO Q.A. Lab. in the U.K.

2. Technical documentation kept at :

Samsung Electronics Co.,Ltd

**which will be made available upon request.
(Manufacturer)**

Samsung Electronics co.,Ltd
#259,KongDan-Dong,GuMi-City
KyungBuk, Korea 730-030

2003-03-25

(place and date of issue)



Whan-Soon Yim / Senior Manager

(name and signature of authorized person)

(Representative in the EU)

Samsung Electronics Euro QA Lab.
Blackbushe Business Park,Saxony Way,
Yateley, Hampshire,GU46 6GG, UK
2003-03-25

(place and date of issue)



In-Seop Lee / Manager

(name and signature of authorized person)

Recycling



Please recycle or dispose of the packaging material for this product in an environmentally responsible manner.

WARNING

- Do not disassemble the printer. Doing so may give you an electric shock.
- If you continuously print many pages, the surface of the output tray may become hot. Be careful not to touch the surface, especially for children.

1

INTRODUCTION

Congratulations on the purchase of your Printer!

This chapter includes:

- **Special Features**
- **Printer Components**
- **Understanding the Control Panel**

Special Features

Your new printer is equipped with special features that improve the print quality, giving you a competitive edge. You can:

Print with excellent quality and high speed



- You can print at up to **1200 x 1200 dpi** (effective output). See page 4.16.
- Prints up to **17 pages-per-minute (Letter size), Up to 16 pages-per-minute (A4 size)**.

Handle paper flexibly

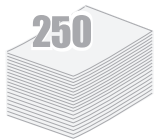

- **Standard 250-sheet tray** and a 1-sheet Manual Feeder support various sizes and types of paper.
- Two output trays; select either **the top output tray (face-down)** or **the rear output tray (face-up)** for the most convenient access.

Create professional documents



- You can customize your documents using **Watermarks**, such as “Confidential.” See page 4.19.
- Print **Posters**. The text and pictures of each page of your document are magnified and printed across the selected sheet of paper. After the document has printed, trim off the white edges of each sheet. Tape the sheets together to form a poster. See page 4.14.

Save your time and money



- Allows you to use the **Toner Save mode** to save toner. See page 4.8.
- Allows you to print multiple pages on one single sheet of paper to save paper (**N-Up printing**). See page 4.10.
- This printer meets **Energy Star** guidelines for energy efficiency.



Print in various environments

- You can print in **Windows 95/98/Me/NT 4.0/2000/XP**.
- Your printer is compatible with **Linux**.
- Your printer comes with both the **Parallel** and the **USB** interface.

Printer Components

Front View

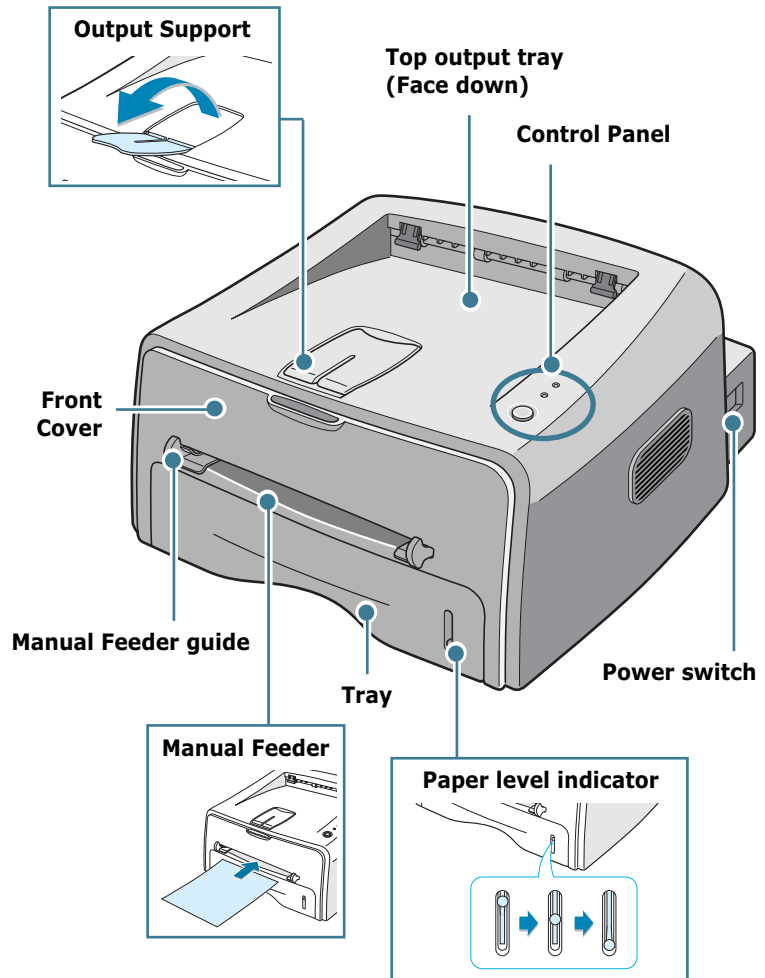

Inside View

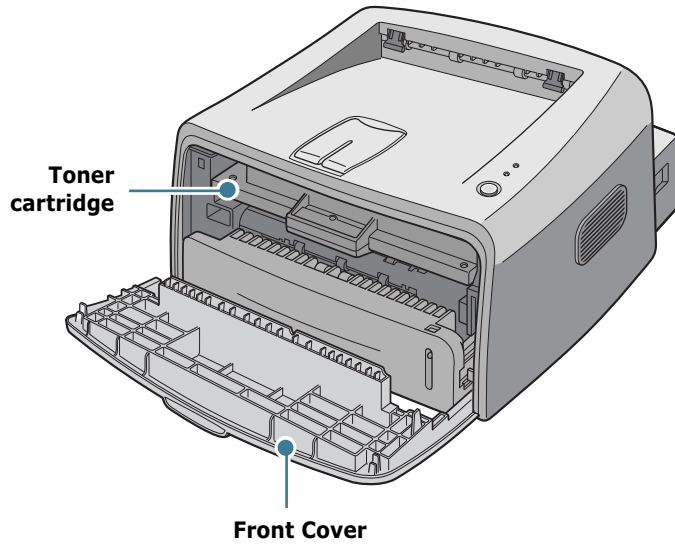

Rear View

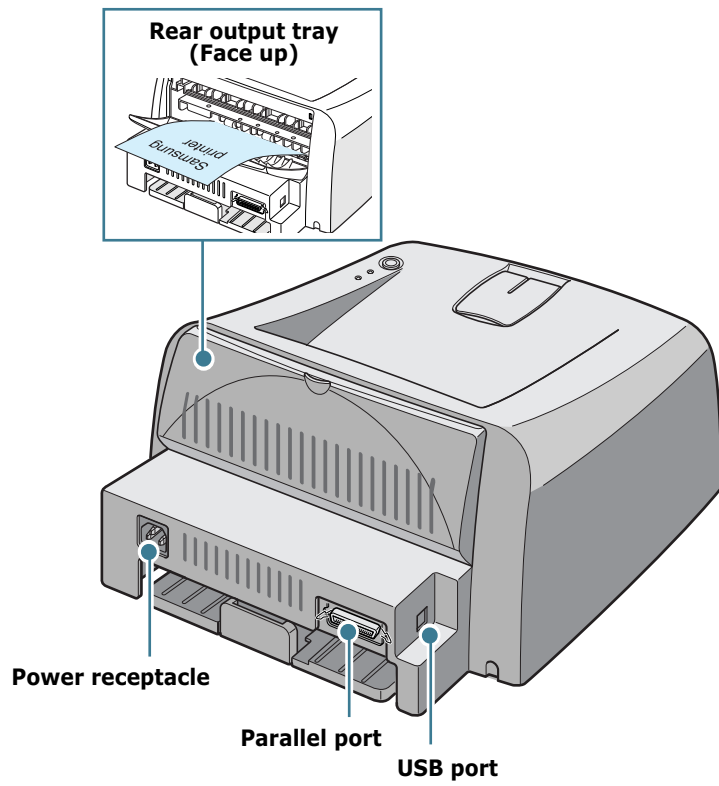

Understanding the Control Panel

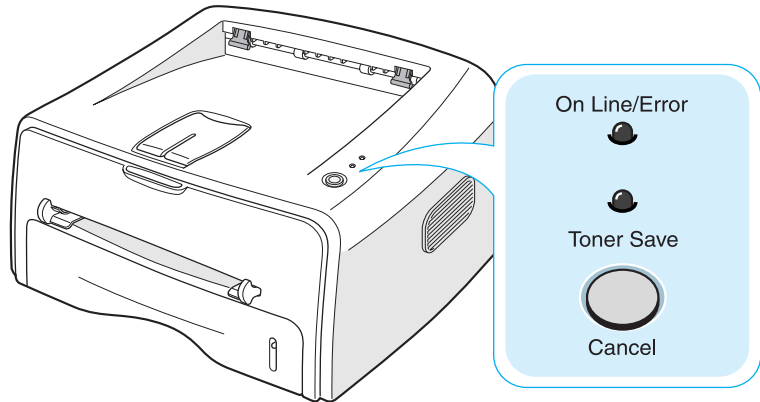

On Line/Error and Toner Save LEDs

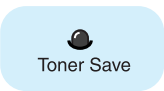
LED	Description
	<p>If the On Line/Error lights green, the printer is ready to print.</p> <p>If the On Line/Error lights red, the printer is experiencing an error, such as jammed paper, the open cover or the empty toner cartridge. See "Troubleshooting Error Messages" on page 6.18.</p> <p>If you press the Cancel button while the printer is receiving data, the On Line/Error LED blinks red to cancel printing.</p> <p>In Manual Feed mode, if there is no paper in the Manual Feeder, the On Line/Error LED blinks red. Load paper into the Manual Feeder and the LED stops blinking.</p> <p>If the printer is receiving data, the On Line/Error LED slowly blinks green. If the printer is printing the received data, the On Line/Error LED blinks green fast.</p>
	<p>If you press the Cancel button in Ready mode, this LED is on and the Toner Save mode is enabled. If you press this button once again, this LED is off and the Toner Save mode is disabled.</p>

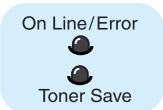
LED	Description
 <p>On Line/Error</p> <p>Toner Save</p>	<p>If the On Line/Error and Toner Save LEDs blink, your system has some problems. To solve the problem, see “Troubleshooting Error Messages” on page 6.18.</p>

Cancel button

Function	Description
Printing demo page	In Ready mode, press and hold this button for about 2 seconds until all LEDs blink slowly, and release.
Printing configuration sheet	In Ready mode, press and hold this button for about 6 seconds until all LEDs blink fast, and release.
Manual feeding	Press this button each time you load a sheet of paper in the manual feeder, when you select Manual Feed for Source from your software application. For detailed information, see “Using the Manual Feeder” on page 3.8.
Cleaning inside printer	In Ready mode, press and hold this button for about 10 seconds until all LEDs turn on, and release. After cleaning the printer, one cleaning sheet is printed.
Canceling print job	<p>Press this button during printing. The On Line/Error LED blinks while the print job is cleared from both the printer and the computer, and then return to Ready mode. This may take some time depending on the size of the print job.</p> <p>In Manual Feed mode, you can't cancel the print job by pressing this button. For detailed information, see “Using the Manual Feeder” on page 3.8.</p>
Toner Save mode on/off	In Ready mode, press this button to turn the Toner Save mode on or off. For detailed information, see page 4.8.

NOTE



2

SETTING UP YOUR PRINTER

This chapter provides step by step information on setting up your printer.

This chapter includes:

- **Unpacking**
- **Installing the Toner Cartridge**
- **Loading Paper**
- **Connecting a Printer Cable**
- **Turning the Printer on**
- **Printing a Demo Page**
- **Installing Printer Software**

Unpacking

- 1 Remove the Printer and all accessories from the packing carton. Make sure that the printer has been packed with the following items:

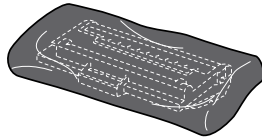

Toner Cartridge

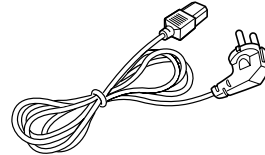

Power Cord

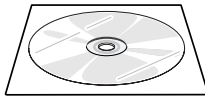

CD-ROM



Setup Guide



Notes:

- If any items are missing or damaged, notify your dealer immediately.
- **Components may differ from one country to another.**
- The CD-ROM contains the printer driver, the User's Guide, and the Adobe Acrobat Reader program.

- 2 Carefully remove all of packing tapes from the printer.

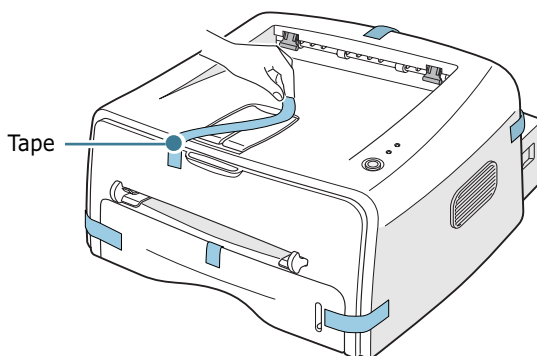

Selecting a Location

Select a level, stable place with adequate space for air circulation. Allow extra space for opening covers and tray. The area should be well-ventilated and away from direct sunlight or sources of heat, cold, and humidity. See the image below for clearance space. Do not place the printer close to the edge of your desk or table!

Clearance Space

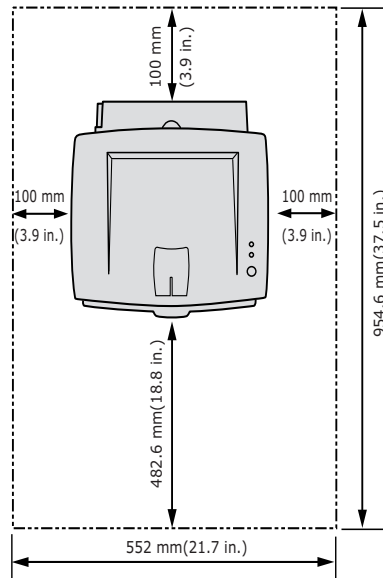

- **Front:** 482.6 mm (enough space so that tray can be removed)
- **Back:** 100 mm (enough space to allow opening of the rear out tray)
- **Right:** 100 mm (enough space for ventilation)
- **Left:** 100 mm

Installing the Toner Cartridge

- 1 Grasp the front cover and pull it toward you to open.

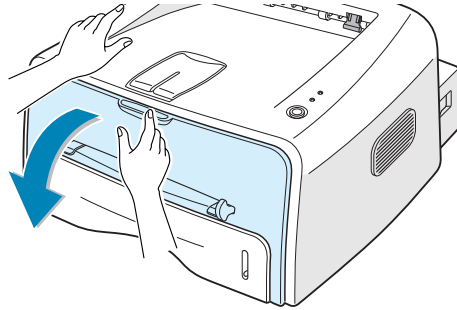

Note: Because the printer is very light, it may be moved when you use it; for example, when opening/closing the tray or installing/removing the toner cartridge. Be careful not to move the printer.

- 2 Remove the toner cartridge from its bag and remove the paper covering the cartridge.

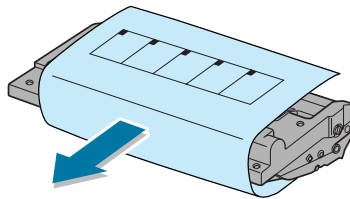

- 3 Gently shake the cartridge from side to side to distribute the toner evenly inside the cartridge.

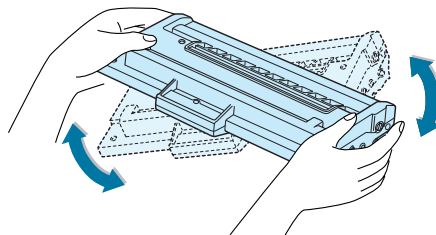

CAUTION:

- To prevent damage, do not expose the toner cartridge to light for more than a few minutes. Cover it with a piece of paper, if left exposed for more than a few minutes.
 - If toner gets on your clothing, wipe it off with a dry cloth and wash clothing in cold water. Hot water sets toner into fabric.
-

4 Locate the cartridge slots inside the printer, one on each side.

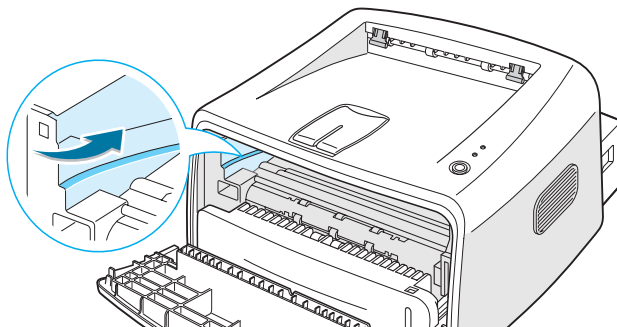

5 Grasp the handle and insert the cartridge in the printer until it snaps into place.

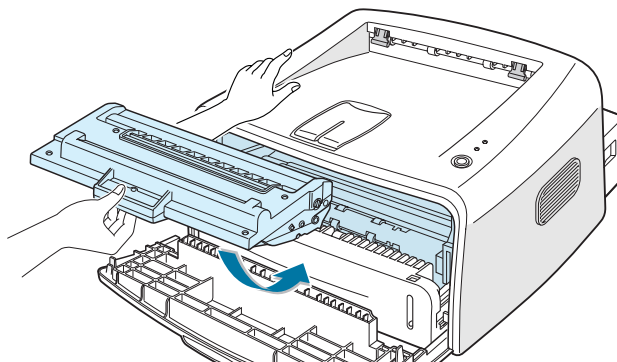

6 Close the front cover. Make sure that the cover is securely closed. If the cover is not firmly closed, printing errors may occur when you print.

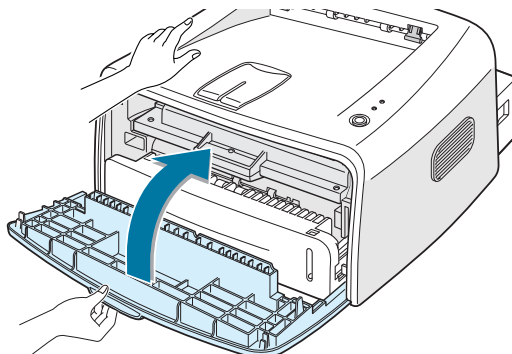

Note: When printing text at 5% coverage, you can expect a toner cartridge life of approximately 3,000 pages (1,000 pages for the toner cartridge that is shipped with the printer).

Loading Paper

You can load approximately 250 sheets of paper in the tray.

- 1 Pull the tray out of the printer.

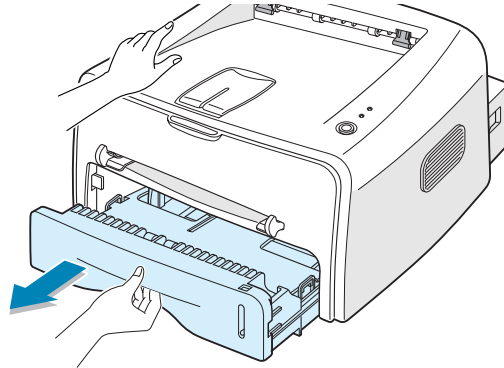

Note: Because the printer is very light, it may be moved when you use it; for example, when opening/closing the tray or installing/removing the toner cartridge. Be careful not to move the printer.

- 2 Push down the pressure plate until it locks in position.

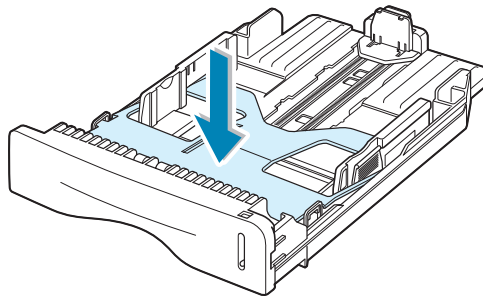

- 3 Prepare a stack of paper for loading by flexing or fanning them back and forth. Straighten the edges on a level surface.

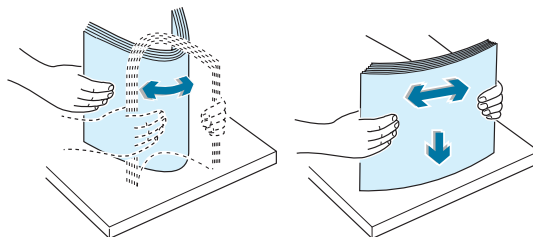

- 4 Load paper **with the print side facing down**.

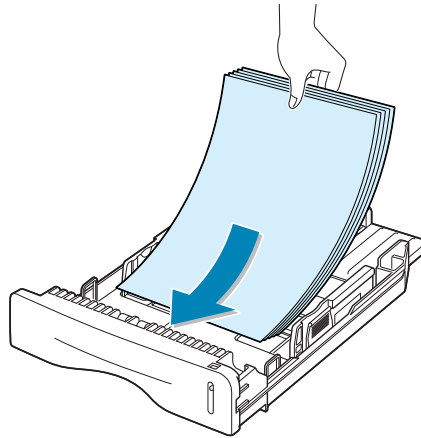

Make sure that all four corners are flat in the tray.

- 5 Pay attention to the paper limit mark on the left inside wall of the tray. Paper overloading may cause paper jams.

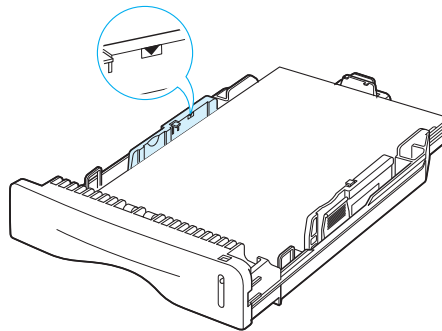

Note: If you want to change the paper size in the tray, see [“Changing the Paper Size in the Tray”](#) on page 2.8 .

- 6 Slide the tray back into the printer.

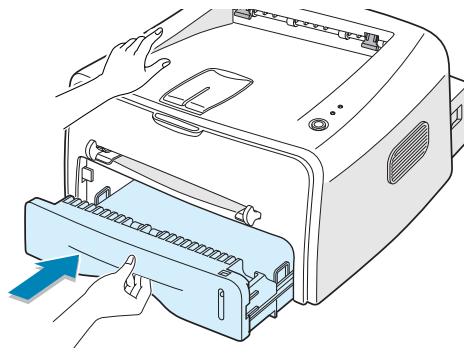

Changing the Paper Size in the Tray

- 1 Pinch the rear guide as shown below to adjust for the paper length.

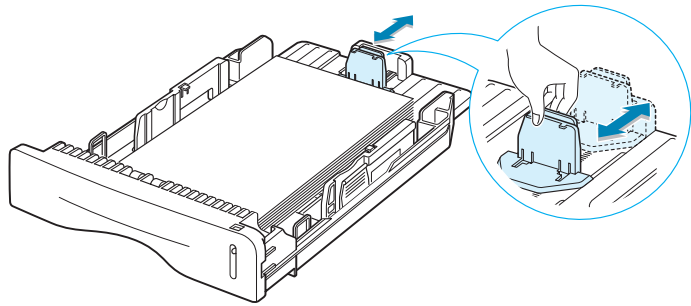

- 2 Pinch the side guide as shown and slide it to the left flush against the paper.

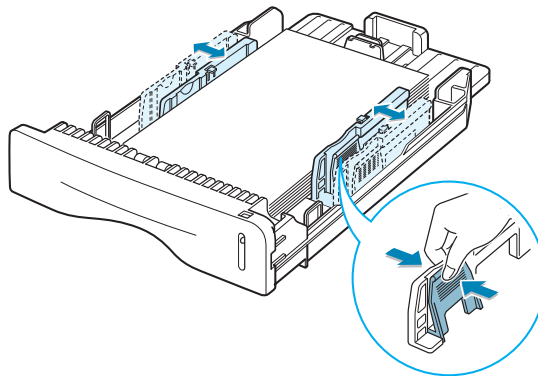

Notes:

- Do not push the width guide far enough to cause the material to warp.
- If you do not adjust the width guide, it may cause paper jam.

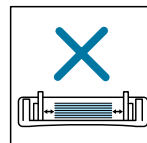
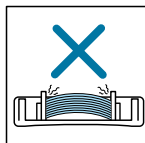
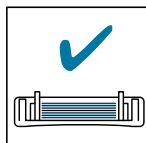

Connecting a Printer Cable

To print from your computer, you need to connect your printer to your computer with either a parallel interface cable or a Universal Serial Bus (USB) cable.

Using a Parallel Cable



Note: To connect the printer to the parallel port of the computer requires a certified parallel cable. You will need to buy a IEEE1284 compliant cable.

- 1 Make sure that both the printer and the computer are turned off.
- 2 Plug the parallel printer cable into the connector on the back of the printer.

Push the metal clips down to fit inside the notches on the cable plug.

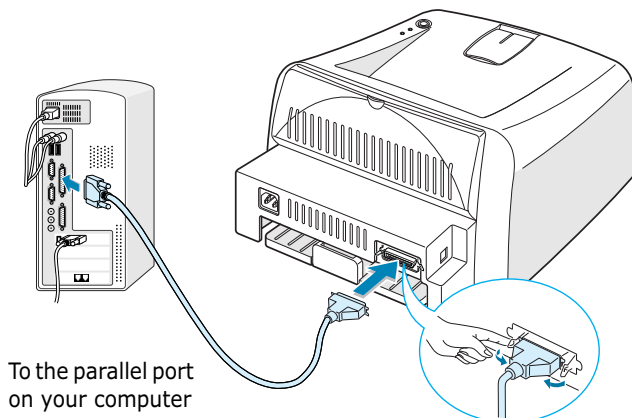

- 3 Connect the other end of the cable to the parallel interface port on your computer, and tighten the screws.

See your computer User's Guide if you need help.

Using a USB Cable



Note: Connecting the printer to the USB port of the computer requires a certified USB cable. You will need to buy a USB 2.0 compliant cable that is within 3m in length.

- 1 Make sure that both the printer and the computer are turned off.
- 2 Plug the USB printer cable into the connector on the back of the printer.

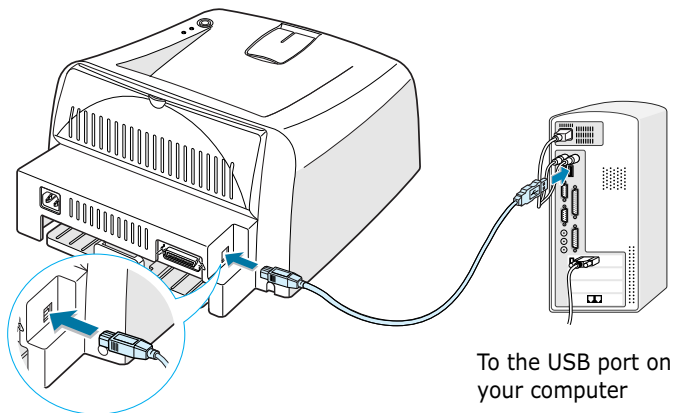

- 3 Connect the other end of the cable to the USB port on your computer.

See your computer User's Guide if you need help.



Notes:

- For using a USB cable, you must be running Windows 98/Me/2000/XP.
- In Windows 98/Me, if you want to print using the USB interface, you must install the USB driver to add the USB port. See page 2.18.
- In Windows 2000/XP, if you want to print using the USB interface, you must install the Printer driver. See page 2.15.

Turning the Printer on

- 1 Plug the power cord into the power receptacle on the back of the printer.
- 2 Plug the other end into a properly grounded AC outlet and turn on the printer using the power switch.

2

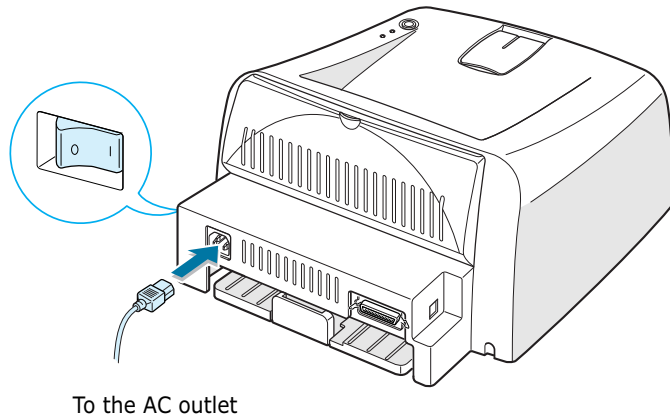

CAUTION:

- The fusing area at the rear portion of the inside of your printer is hot when powered. Be careful not to be burned when accessing this area.
 - Do not disassemble the printer when it is powered. Doing so may give you an electric shock.
-

Printing a Demo Page

Print a demo page or a configuration sheet to make sure that the printer is operating correctly.

- 1 Hold down the **Cancel** button for about 2 seconds to print a demo page.

OR

Hold down the **Cancel** button for about 6 seconds to print a configuration sheet.

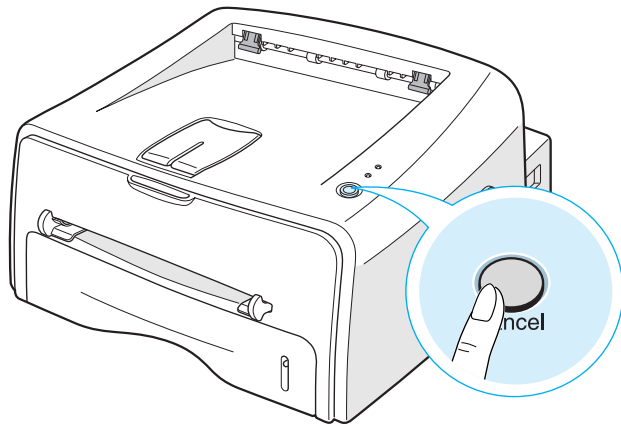

- 2 The Demo page or the configuration sheet shows the printer's current configuration.

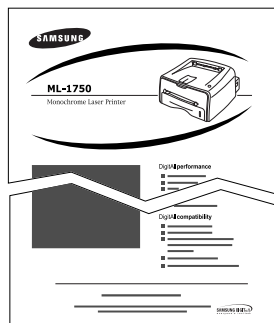

Demo page

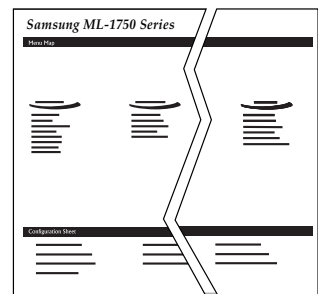

Configuration sheet

Installing Printer Software

The supplied CD-ROM contains Windows printing software, Linux printing software, on-line User's Guide and Acrobat Reader to view the User's Guide.

If you are printing from Windows

You can install the following printer software using the CD-ROM.

- **Printer driver** for windows. Use this driver to take full advantage of your printer's features. See page 2.15.
- **Status Monitor** allows you to see the printing status of the printer. See page 4.26.
- **Remote Control Panel** for DOS application. Go to "Printing from DOS Applications" on page 7.12, for information about installing the Remote Control Panel and printing from DOS applications.
- **USB driver** for adding the USB port to Windows 98/Me. You must first install the USB driver for the USB connection in Windows 98/Me. In Windows 2000/XP, the USB port is provided, so you don't have to install the USB driver. Just install the printer software; see page 2.15.

If you are printing in Linux

Go to "Using Your Printer in Linux" on page 7.2, for information about installing the Linux driver.

Printer Driver Features

Your printer drivers will support the following standard features:

- Paper source selection
- Paper size, orientation and media type
- number of copies

Table below lists a general overview of features supported by your printer drivers.

Feature	Printer Driver		
	Win9x/Me	Win2000/XP	NT4.0
Toner Save	Y	Y	Y
Print quality option	Y	Y	Y
Poster printing	Y	Y	Y
Multiple pages per sheet (N-up)	Y	Y	Y
Fit to page printing	Y	Y	Y
Scale printing	Y	Y	Y
Watermark	Y	Y	Y
Overlay	Y	Y	Y

Installing Printer software in Windows

System Requirements

Verify the following:

- At least **32 MB** (Windows 9x/Me), **64 MB** (Windows 2000/NT), **128 MB** (Windows XP) or more of RAM is installed on your PC.
- There is at least **300 MB** of free disk space on your PC.
- All applications are closed on your PC before beginning installation.
- Windows 95, Windows 98, Windows Me, Windows NT 4.0, Windows 2000 or Windows XP.
- At least Internet Explorer 5.0.

2

Installing Printer Software

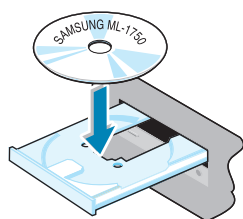

- 1 Place the CD-ROM in the CD-ROM drive. Installation will start automatically.

If the CD-ROM drive does not automatically run:

Select **Run** from the **Start** menu, and type **x:\cdsetup.exe** in the Open box (where **x** is the drive letter for the CD-ROM drive), then click **OK**.



Note: If the **New Hardware Found** window appears during the installation procedure, click in the upper right corner of the box, or click **Cancel**.

- 2 When the language selection window appears, select the appropriate language.

If you can't find the desired language from the screen, scroll through the screen using the scroll button on the bottom right of the screen.

3 Click **Install the Samsung Software on your PC (SPL Driver)**.

If you want to use the Status Monitor, click **Install the Samsung Software-II on your PC (Status Monitor)**.

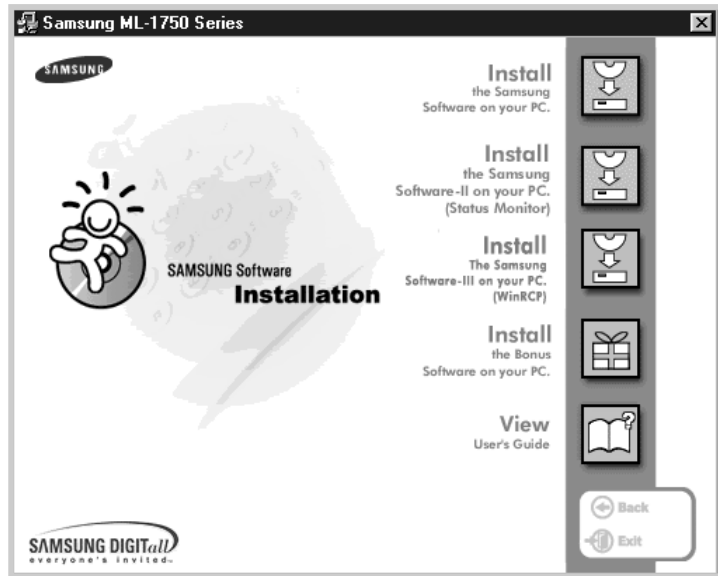

4 The **Welcome** window opens. Click **Next**.

5 Follow the instructions on the screen to complete the installation.

Reinstalling Printer software

Reinstall is required if your installation fails.

1 From the **Start** menu, select **Programs**.

2 Select **Samsung ML-1750 Series**, and then **Samsung ML-1750 Series Driver Maintenance**.

3 The Samsung ML-1750 Series Driver Maintenance window appears. Click **Repair** and then click **Next**.

4 When reinstallation is done, click **Finish**.

Removing Printer software

- 1 From the **Start** menu, select **Programs**.
- 2 Select **Samsung ML-1750 Series**, and then **Samsung ML-1750 Series Driver Maintenance**.
- 3 The Samsung ML-1750 Series Driver Maintenance window appears. Check **Remove** and then click **Next**.
- 4 When you are asked to confirm your selection, click **OK**.

The Samsung ML-1750 Series printer driver and all of its components are removed from your computer.

- 5 When removing is completed, click **Finish**.

Changing the Display Language

After installation of the software, you can change the display language. If you installed the Remote Control Panel or the Status Monitor, the selected language is applied to them.

- 1 From the **Start** menu, select **Programs**.
- 2 Select **Samsung ML-1750 Series**, and **Language Selection**.
- 3 Select the desired language from the language selection window, and click **OK**.

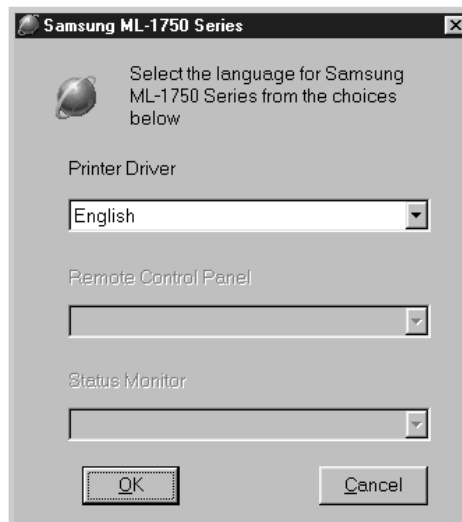

Installing the USB Driver in Windows 98/Me

- 1 Connect the printer to your computer using the USB cable and turn them on. For detailed information, see page 2.10.
- 2 The **Add New Hardware Wizard** window appears. Click **Next**.
- 3 Place the CD-ROM in the CD-ROM drive and check **Search for the best driver for your device** and click **Next**.
- 4 Check **CD-ROM drive** and click **Browse**, and choose **x:\USB** (where **x** is the drive letter for the CD-ROM drive). Click **Next**.



- 5 Click **Next**. The USB driver will be installed.
- 6 When the installation is completed, click **Finish**.
- 7 When the language selection window appears, select the appropriate language.



Note: If you already installed the printer software, this screen doesn't appear.

- 8 Follow the instructions on the screen to complete the printer software installation. For more details, see page 2.15.



Notes:

- If you want to use your printer with the parallel cable, remove the USB cable and connect the parallel cable. Then reinstall the printer driver.
 - If your printer doesn't work properly, reinstall the printer driver.
-

NOTE



3

Using Print Materials

This chapter will help you understand types of paper you can use with this printer and how to properly load paper in the tray for the best print quality.

This chapter includes:

- **Choosing Paper and Other Materials**
- **Selecting the Output Location**
- **Loading Paper**
- **Printing on Envelopes**
- **Printing on Labels**
- **Printing on Transparencies**
- **Printing on Card Stock or Custom-sized Materials**
- **Printing on Preprinted Paper**

Choosing Paper and Other Materials

You can print on a variety of print materials, such as plain paper, envelopes, labels, transparencies and so on. See “Paper Specifications” on page 7.22. To get the best possible print quality, use only high-quality copier-grade paper.

When you choose print materials, consider the followings:

- **Desired outcome:** The paper you choose should be appropriate for the project.
- **Size:** You can use any size paper that fits easily within the paper adjusters of the paper feeder.
- **Weight:** Your printer supports paper weight as follows:
 - 16~24 lbs (60~90g/m²) bond for the tray
 - 16~43 lbs (60~163 g/m²) bond for the manual feeder
- **Brightness:** Some papers are whiter than others and produce sharper, more vibrant images.
- **Surface smoothness:** The smoothness of the paper affects how crisp the printing looks on the paper.



CAUTION: Using a material that does not conform to the specification listed in the paper specification can cause problems that may require service. This service is not covered by the warranty or service agreements.

Sizes and Capacities

Size	Input Source/Capacity ^a	
	Tray	Manual Feeder
Plain Paper		
Letter (8.5 x 11 in.)	250	1
Legal (8.5 x 14 in.)	250	1
Executive (7.25 x 10.5 in.)	250	1
Folio (8.5 x 13 in.)	250	1
A4 (210 x 297 mm)	250	1
B5 (182 x 257 mm)	250	1
A5 (148 x 210 mm)	250	1
A6 (105 x 148 mm)	250	1
Envelopes^b		
No. 10 (4.12 x 9.5 in.)	-	1
Monarch (3.87 x 7.5 in.)	-	1
C5 (162 x 229 mm)	-	1
DL (110 x 220 mm)	-	1
B5 (176 x 250 mm)	-	1
C6 (114 x 162 mm)	-	1
Labels^b		
Letter (8.5 x 11 in.)	-	1
A4 (210 x 297 mm)	-	1
Transparencies^b		
Letter (8.5 x 11 in.)	-	1
A4 (210 x 297 mm)	-	1
Card stocks^b	-	1

a. Depending on paper thickness, the maximum capacity may be reduced.

b. If you are experiencing excessive jamming, feed one sheet at a time through the manual feeder.

Guidelines for Paper and Special Materials

When selecting or loading paper, envelopes, or other special materials, keep these guidelines in mind:

- Attempting to print on damp, curled, wrinkled, or torn paper can cause paper jams and poor print quality.
- Use cut-sheet paper only. You cannot use multi-part paper.
- Use only high-quality, copier grade paper for the best print quality.
- Do not use paper that has been already printed on or that has been fed through a photocopier.
- Do not use paper with irregularities, such as tabs or staples.
- Do not attempt to load any feeder during printing and never overfill the feeder. This could cause a paper jam.
- Avoid paper with embossed lettering, perforations, or texture that is too smooth or too rough.
- Colored paper should be of the same high quality as white photocopy paper. The pigments must withstand the printer's fusing temperature of 400°F (205°C) for 0.1 second without deterioration. Do not use paper with a colored coating that was added after the paper was produced.
- Preprinted forms must be printed with nonflammable, heat-resistant ink that do not melt, vaporize, or release hazardous emissions when subject to the printer's approximately 400°F (205°C) fusing temperature for 0.1 second.
- Store paper in its ream wrapper until ready to use. Place cartons on pallets or shelves, not on the floor.
- Do not place heavy objects on top of the paper, whether it is packaged or unpackaged.
- Keep paper away from moisture, direct sunlight or other conditions that can cause it to wrinkle or curl.

Selecting the Output Location

The printer has two output locations: the rear output tray and the top output tray.

▼ Top output tray

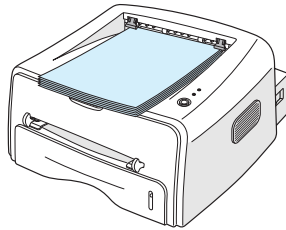

▼ Rear output tray

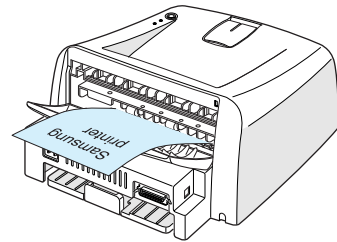

3

To use the top output tray, be sure the rear output tray is closed. To use the rear output tray, open it.



Notes:

- If paper coming out of the top output tray has problems, such as excessive curl, try printing to the rear output tray.
- To avoid paper jams, do not open or close the rear output tray while the printer is printing.

Printing to the Top Output Tray (Face down)

The top output tray collects paper face-down, in correct order. The top output tray should be used for most print jobs.

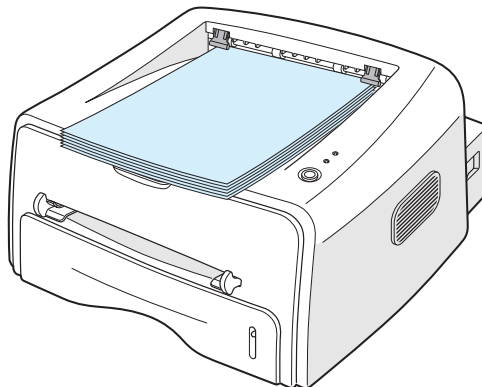

Note: If you continuously print many pages, the surface of the output tray may become hot. Be careful not to touch the surface, especially for children.

Printing to the Rear Output Tray (Face up)

The printer always prints to the rear output tray if it is open. Paper comes out of the printer face-up, and each time a sheet of paper comes out, it falls down from the printer.

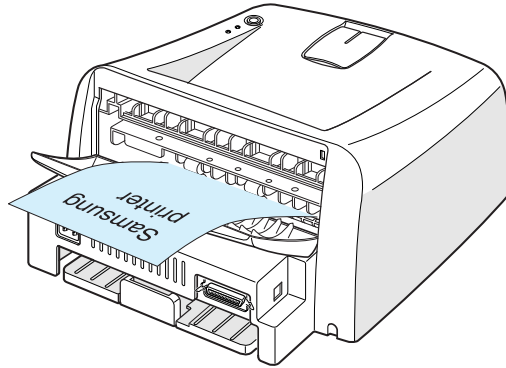

Printing from the Manual Feeder to the rear output tray provides the **straight paper path**. Opening the rear output tray might improve the output quality with the following:

- envelopes
- labels
- transparencies

To open the rear output tray:

- 1 Open the rear door by pulling it down. The cover functions as the output tray.

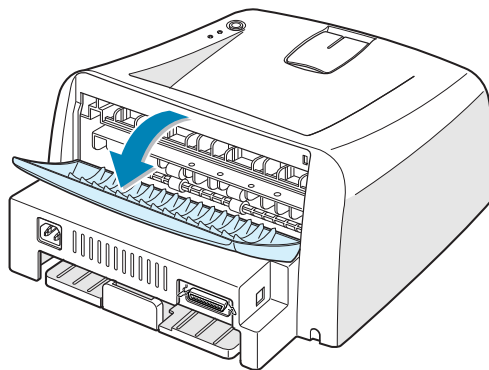

Note: Please be careful when you open the rear cover. The inside of the printer maybe hot.

- 2 If you do not want to print to the rear output tray then close the tray. The pages will stack on the top output tray.

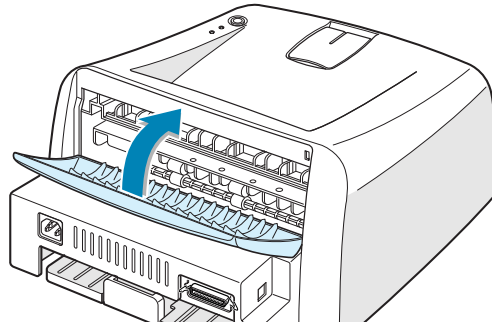

Loading Paper

Proper paper loading helps prevent paper jams and ensure trouble-free printing. Do not remove the tray while a job is printing. Doing so may cause a paper jam. See “Sizes and Capacities” on page 3.3 for acceptable paper size and capacities for each tray.

The paper level bar on the front of the paper tray shows the amount of paper currently in the tray. When the tray is empty, the indicator of the bar is lowered.

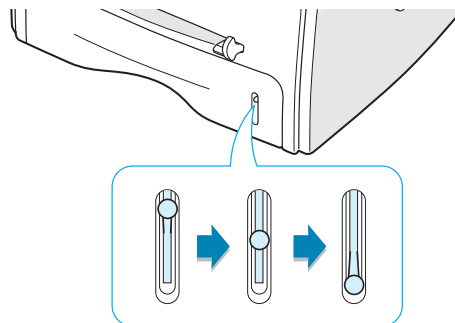

Paper full ▲

▲ Paper empty

Using the Tray

The tray holds 250 sheets of paper. See “Sizes and Capacities” on page 3.3 for acceptable paper size and capacities of each tray.

Load a stack of paper into the tray and print. for details about loading paper in the tray, see “Loading Paper” on page 2.6.

Using the Manual Feeder

If you select **Manual Feed** in the **Source** option, you can manually load paper in the manual feeder. Manually loading paper can be helpful when you want to check the print quality after each page is printed.

If you experience a paper jam from the tray, load one sheet of paper at a time into the manual feeder.

- 1 Load the print material in the manual feeder **with the print side up**.

Adjust the paper guide against the print material without bending the paper.

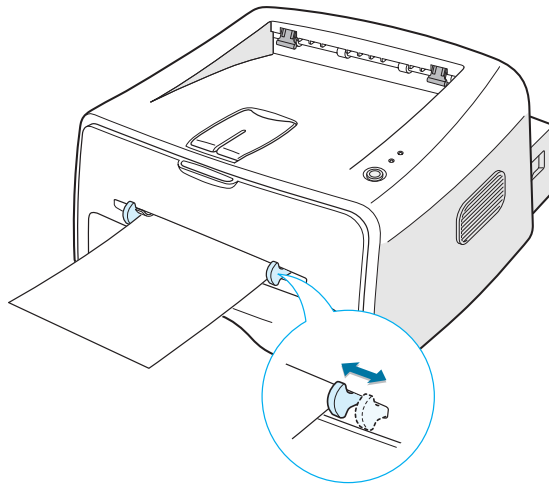

- 2 When you print a document, you must select **Manual Feed** for **Source** from the software application, and then select the correct paper size and type. For details, see page 4.6.
- 3 Press the **Cancel** button on the printer to start feeding.
- 4 Printing is started.
- 5 If you are printing multiple pages, load the next sheet after the first page prints out, and press the **Cancel** button.

Repeat this step for every page to be printed.

In Manual Feed mode, you can't cancel a print job by pressing the **Cancel** button.

To cancel a print job in Manual Feed mode:

- 1 Turn the printer off.
- 2 Double-click the  icon at right bottom of the window.

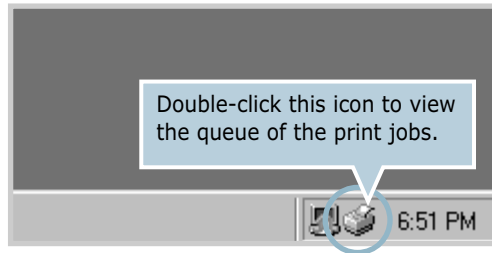

3

- 3 Select a job you want to cancel.

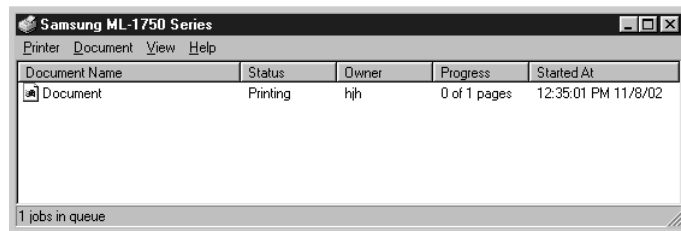

- 4 For Windows 9x/Me, select **Cancel Printing** from **Document** menu.
For Windows NT/2000/XP, select **Cancel** from **Document** menu.

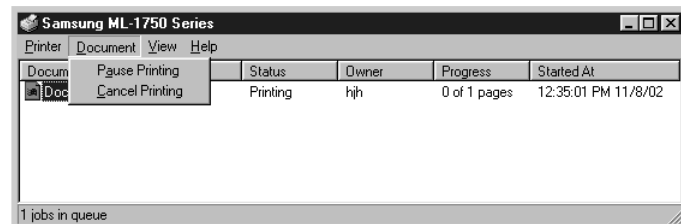

- 5 When the jobs are removed from the list. Turn the printer on.

Printing on Envelopes

Guidelines

- Only use envelopes recommended for laser printers. Before loading envelopes in the manual feeder, make sure that they are undamaged and are not stuck together.
- Do not feed stamped envelopes.
- Never use envelopes with clasps, snaps, windows, coated lining, or self-stick adhesives. These envelopes may severely damage the printer.

- 1 Open the rear output tray. Load the envelopes into the manual feeder **with the flap side down**.

The stamp area is **on the left side** and the end of the envelope **with the stamp area enters the feeder first**.

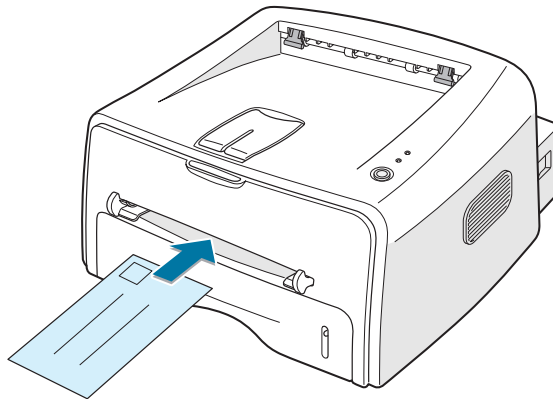

- 2 Adjust the guide to the edge of the envelope stack.

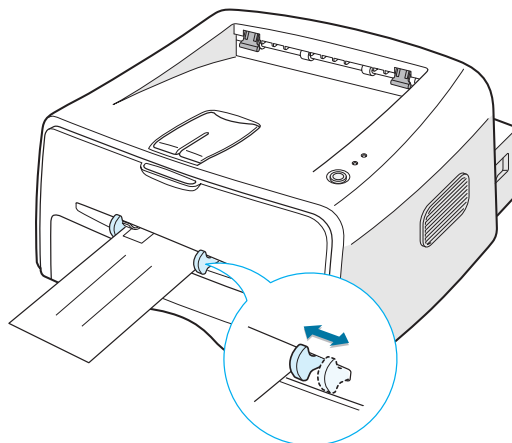

3 When you print on envelopes, you must select **Manual Feed** for **Source** from the software application, and then select the correct paper size and type. For details, see page 4.6.

4 Press the **Cancel** button to start feeding.



Note: Please be careful when you open the rear cover. The inside of the printer maybe hot.

5 Printing is started. Close the rear output tray after the printing is completed.

Printing on Labels

Guidelines

- Only use labels recommended for laser printers.
- Verify that the labels' adhesive material can tolerate fusing temperature of 200°C (392°F) for 0.1 second.
- Make sure that there is no exposed adhesive material between the labels. Exposed areas can cause labels to peel off during printing, which can cause paper jams. Exposed adhesive can also cause damage to printer components.
- Do not feed a sheet of label through the printer more than once. The adhesive backing is designed for one pass through the printer.
- Do not use labels that are separating from the backing sheet or are wrinkled, bubbled, or otherwise damaged.

- 1 Open the rear output tray. Load labels in the manual feeder **with print side up**.

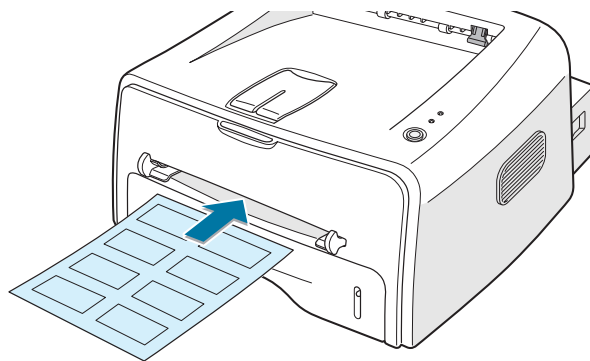

- 2 Adjust the guide to fit the width of the labels.

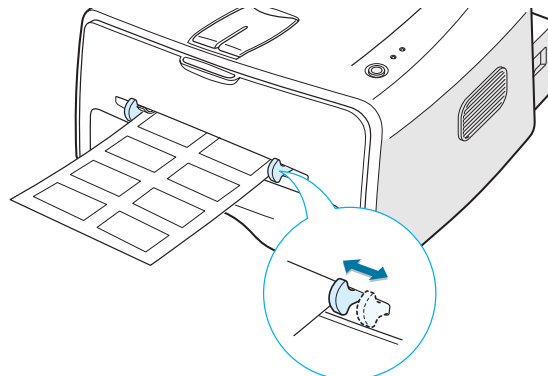

- 3 When you print on labels, you must select **Manual Feed** for **Source** from the software application, and then select the correct paper size and type. For details, see page 4.6.



Note: Please be careful when you open the rear cover. The inside of the printer maybe hot.

- 4 Press the **Cancel** button to start feeding. Printing is started. Close the rear output tray after the printing is completed.



Note: To prevent labels from sticking to each other, do not let the printed label sheets stack up as they are printed out.

Printing on Transparencies

Guidelines

- Only use transparencies recommended for use in laser printers.
- Ensure that transparencies are not wrinkled, curled, or have any torn edges.
- Hold the transparencies by the edges and avoid touching the print side. Oils deposited on the transparency can cause print quality problems.
- Be careful not to scratch or leave fingerprints on the print side.

- 1 Open the rear output tray. Load transparencies in the manual feeder **with print side up**, and the **top with the adhesive strip going first**.

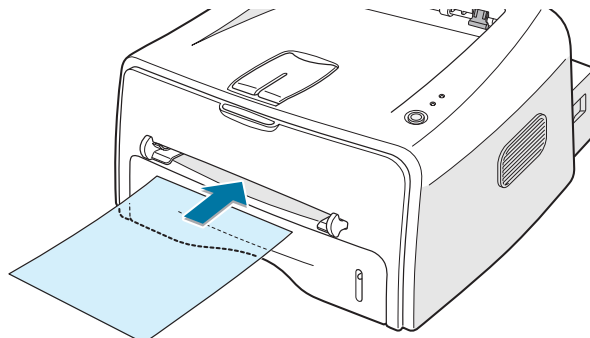

- 2 Adjust the guide to fit the width of the transparencies.

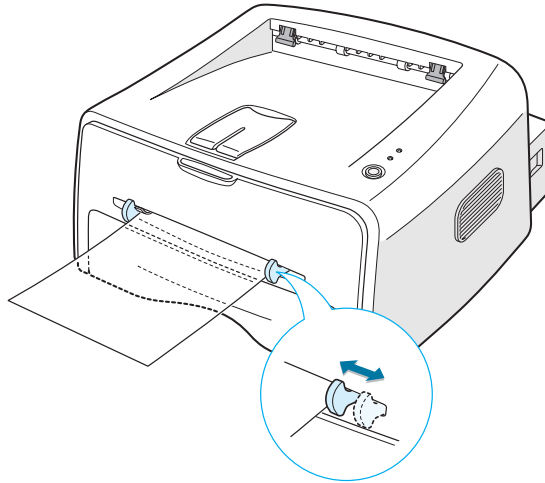

- 3 When you print on transparencies, you must select **Manual Feed** for **Source** from the software application, and then select the correct paper size and type. For details, see page 4.6.



Note: Please be careful when you open the rear cover. The inside of the printer maybe hot.

- 4 Press the **Cancel** button to start feeding. Printing is started. Close the rear output tray after the printing is complete.



Notes:

- To prevent transparencies from sticking to each other, do not let the printed sheets stack up as they are printed out.
 - Place transparencies on a flat surface after removing them from the printer.
-

Printing on Card Stock or Custom-sized Materials

Postcards, 3.5 by 5.83 in.(index) cards and other custom-sized materials can be printed with this printer. The minimum size is 76 by 127mm(3.0 by 5.0 in.) and the maximum size is 216 by 356mm(8.5 by 14 in.).

Guidelines

- Always insert the short-edge into the Manual Feeder first. If you want to print in landscape mode, make this selection through your software. Inserting paper long-edge first may cause a paper jam.
- Do not print on media smaller than 76mm (3.0 in.) wide or 127mm(5.0 in.) long.
- When you print on 76mm x 127mm sized media with loading into the tray, open the rear output tray.

3

- 1 Open the rear output tray. Load print material **with print side up**, short edge first and against the left edge of the feeder.

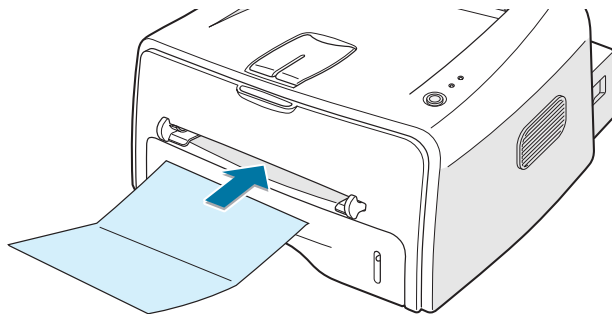

- 2 Adjust the guide to fit the width of the material.

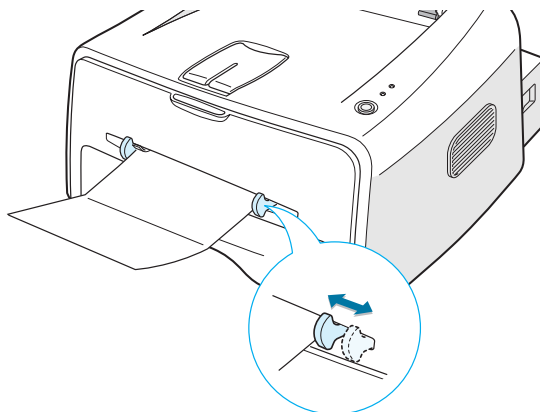

- 3 When you print on card stocks or the custom-sized paper, you must select **Manual Feed** for **Source** from the software application, and then select the correct paper size and type. For details, see page 4.6.



Note: If the size of your print material is not listed in the **Size** box in the **Paper** tab of the printer driver properties, click **Add Custom** button and set the size manually. See page 4.6.

- 4 Press the **Cancel** button to start feeding.
Printing is started. Close the rear output tray after the printing is completed.

Printing on Preprinted Paper

Preprinted paper is paper that has some type of printing placed on it before it is sent through the printer (paper that has a preprinted logo at the top of the page, for example).

Guidelines

- Letterheads must be printed with heat-resistant ink that will not melt, vaporize, or release hazardous emissions when subjected to the printer's fusing temperature of 400 °F (205 °C) for 0.1 second.
- Ink on letterheads must be non-flammable and should not adversely affect any printer rollers.
- Forms and letterheads should be sealed in a moisture-proof wrapping to prevent changes during storage.
- Before you load preprinted paper as forms and letterheads, verify that the ink on the paper is dry. During the fusing process, wet ink can come off preprinted paper.



Note: Please avoid using carbon paper because it may cause the printer a mechanical trouble.

- 1 Load letterheads into the tray you want to use, as shown in the figures below. Adjust the guides to fit the width of the paper stack.

Load with the design face down, bottom edge towards the printer.

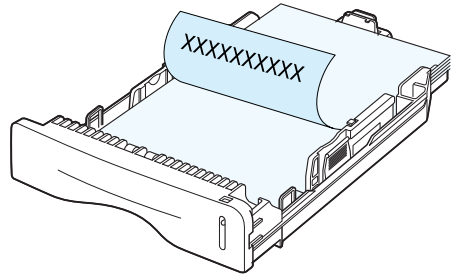

Load with the design face up, top edge towards the printer.

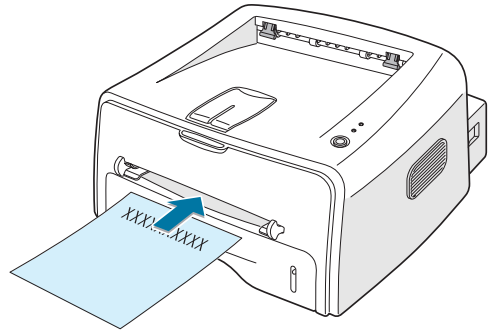

- 2 When you print, configure the paper source, type and size properly in the software application. For details, see page 4.6.

NOTE



4

Printing Tasks

This chapter explains the printing options and common printing tasks.

This chapter includes:

- **Printing a Document**
- **Setting Paper Properties**
- **Using the Toner Save Mode**
- **Printing Multiple Pages on One Sheet of Paper (N-Up Printing)**
- **Scaling Your Document**
- **Fitting Your Document to a Selected Paper Size**
- **Printing Posters**
- **Setting Graphic Properties**
- **Printing Watermarks**
- **Printing Overlays**
- **Using the Status Monitor**
- **Setting Up Locally Shared Printer**

Printing a Document

The following procedure describes the general steps required for printing from various Windows applications. The exact steps for printing a document may vary depending on the application program you are using. Refer to the User's Guide of your software application for the exact printing procedure.

- 1 Open the document you want to print.
- 2 Select **Print** from the **File** menu. The Print window is displayed (It may look slightly different depending on your application).

The basic print settings are selected within the Print window. These settings include the number of copies and print range.

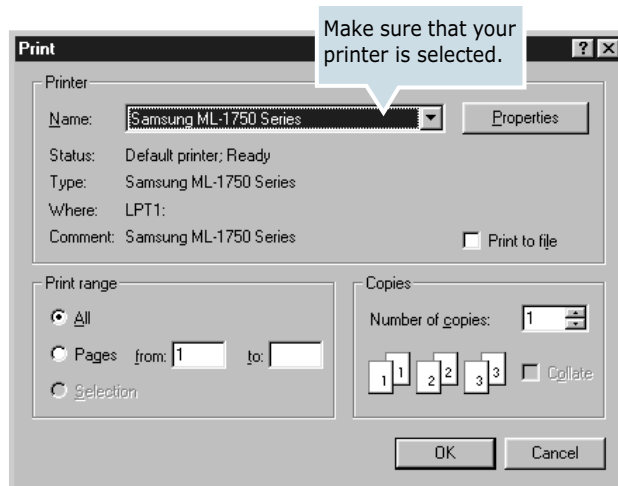

- 3 To take advantage of the printer features provided by your printer, click **Properties** in the application's print window and go to step 4.

If you see **Setup**, **Printer**, or **Options**, click that button instead. Then click **Properties** in the next screen.

- Now you see the Samsung ML-1750 Series Properties window, which allows you to access all the information you will need when using your printer.

The **Layout** tab is first displayed.

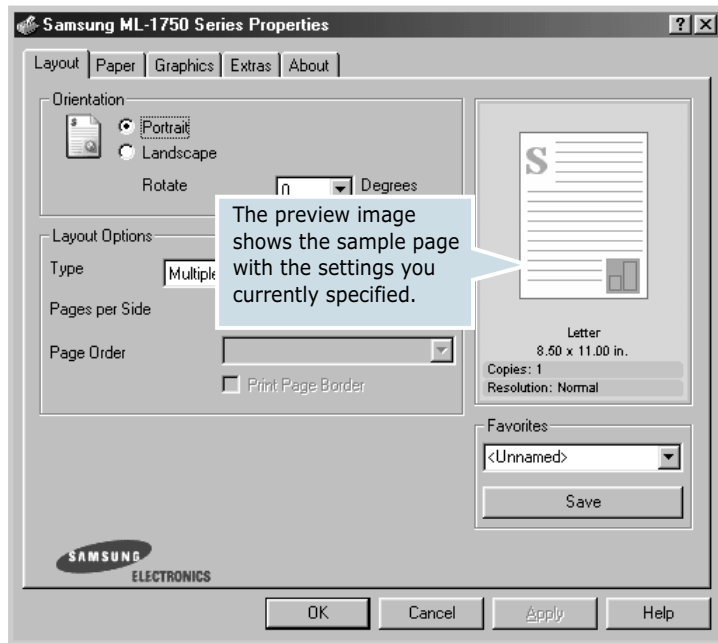

If necessary, select the **Orientation** option.

The **Orientation** option allows you to select the direction in which information is printed on a page.

- **Portrait** prints across the width of the page, letter style.
- **Landscape** prints across the length of the page, spreadsheet style.
- **Rotate** allows you to rotate the page in the selected degrees. You can select **0** or **180** degrees.

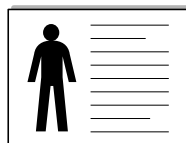

▲ Landscape

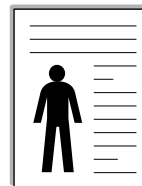

▲ Portrait

- From the **Paper** tab, select the paper source, size and type. For further details, see page 4.6.
- Click other tabs on the top of the Samsung ML-1750 Series Properties window to access other features, if needed.

- 7 When you complete setting the properties, click **OK** until the Print window is displayed.
- 8 Click **OK** to start printing.



Notes:

- Most Windows applications will override settings you specify in the printer driver. Change all print settings available in the software application first, and change any remaining settings using the printer driver.
- The settings you change remain in effect only while you are using the current program. **To make your changes permanent**, make them in the Printers folder. Follows this procedure.

- 1 Click the Windows **Start** button.
- 2 For Windows 9x/Me/2000/NT, select **Settings**, and then **Printers**.
For Windows XP, select **Printers and Faxes**.
- 3 Select the **Samsung ML-1750 Series** printer.
- 4 Click the right mouse button on the printer icon and:
 - In Windows 9x/Me, select **Properties**.
 - In Windows 2000/XP, select **Printing Preferences**.
 - In Windows NT, select **Document Defaults**.
- 5 Change the settings on each tab, and click **OK**.

Canceling a Print Job

There are two ways to cancel a print job.

To stop a print job from the Control Panel

Press the **Cancel** button on the control panel.

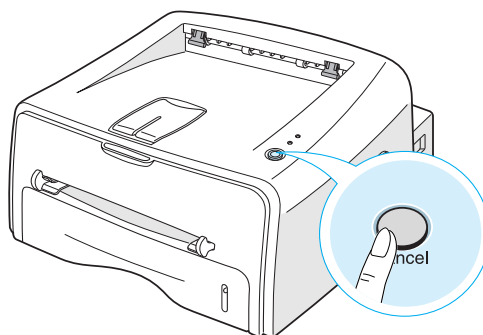

The printer will finish printing the page that is moving through the printer and delete the rest of the print job. Pressing **Cancel** cancels only the current job in the printer. If more than one print job is in the printer memory, **Cancel** must be pressed once for each job.

To stop a print job from the Printers folder

- 1 From the windows **Start** menu, select **Settings**.
- 2 Select **Printers** to open the Printers window, and double-click the **Samsung ML-1750 Series** icon.
- 3 From the **Document** menu, select **Cancel Printing** (Windows 9x/Me) or **Cancel** (Windows NT 4.0/2000/XP).

Using a Favorite Setting



The **Favorites** option, which is visible on each properties tab, allows you to save the current properties settings for future use.

To save a Favorites item:

- 1 Change the settings as needed on each tab.
- 2 Enter a name for the item in the **Favorites** input box.
- 3 Click **Save**.

To use a saved setting, just select the item from the **Favorites** drop down list.

To delete a favorite setting item, select the desired item from the list and click **Delete**.

You can also restore the printer driver's default settings by selecting **Printer Default** from the list.

Using Help

This printer has a help screen that can be activated by the **Help** button in the printer's properties window. These help screen give detailed information about the printer features provided by the printer driver.

You can also click  from the upper right hand corner, and then click on any setting.

Setting Paper Properties

Use the following options to set the basic paper handling needs when you access the printer properties. See page 4.2 for more information on accessing printer properties.

Click the **Paper** tab to access various paper properties.

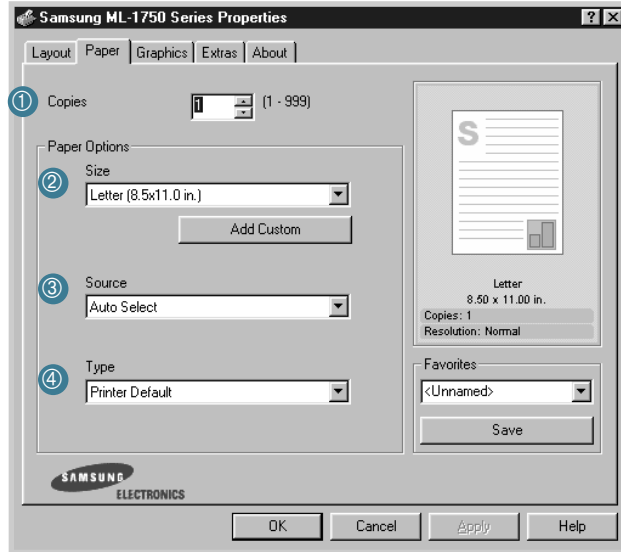

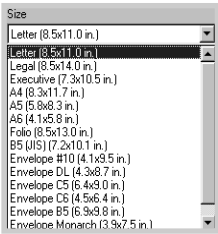
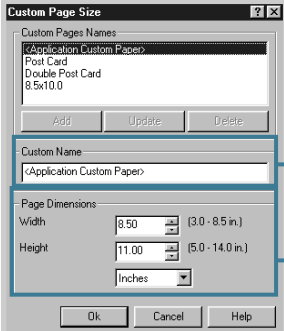
Property	Description
<p>①</p> 	<p>Copies allows you to choose the number of copies to be printed. You can enter up to 999.</p>
<p>②</p> 	<p>Size option allows you to choose the size of paper you loaded into the tray.</p> <p>If the required size is not listed in the Size box, click Add Custom. When the Custom Page Size window appears, set the paper and click OK. The size setting appears in the size list so that you can select it.</p>  <p>Enter the custom name you want to use.</p> <p>Enter the paper size.</p>

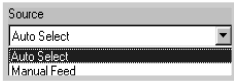
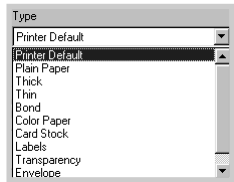
Property	Description
<p>③</p> 	<p>Make sure that Source is set to the corresponding paper tray.</p> <p>Manual Feed source is used when you use the Manual Feeder to print using special materials. You have to load one sheet at a time into the the printer. see page 3.8.</p> <p>If the paper source is set to Auto Select, the printer automatically selects paper from the Manual Feeder first and then from the Tray.</p>
<p>④</p> 	<p>Make sure the Type is set to Printer Default. If you load a different type of print materials, select the corresponding paper type. For further information on print materials, refer to chapter 3 "Using Print Materials".</p> <p>If you use cotton paper, set the paper type to Thick for the best printing.</p> <p>To use recycled paper, which weights from 20lb to 24lb, or other colored paper, select Color Paper.</p>

Using the Toner Save Mode

Toner Save mode allows the printer to use less toner on each page. Selecting this option will extend the life of your toner cartridge and reduce your cost per page, but will reduce print quality.

There are two ways to enable the Toner Save mode:

From the Control Panel

Press the **Cancel** button on the control panel. The printer must be in Ready mode (**On Line/Error** green LED is on).

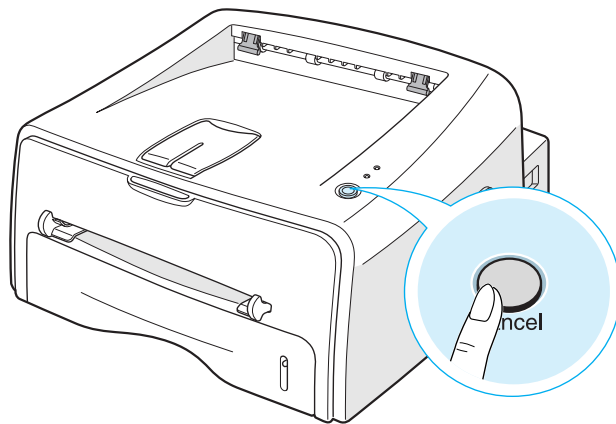

- If the **Toner Save** LED is on, the mode is enabled and the printer uses less toner to print a page.
- If the **Toner Save** LED is off, the mode is disabled and the printer prints in the normal mode.

From the software application

- 1 To change the print settings from your software application, access the printer properties. See page 4.2.
- 2 Click the **Graphics** tab, and select the **Toner Save** option. You can select from:
 - **Printer Setting**: If you select this option, this feature is determined by the setting you've made on the control panel of the printer.
 - **On**: Select this option to allow the printer to use less toner on each page.
 - **Off**: If you don't need to save toner to print a document, select this option.

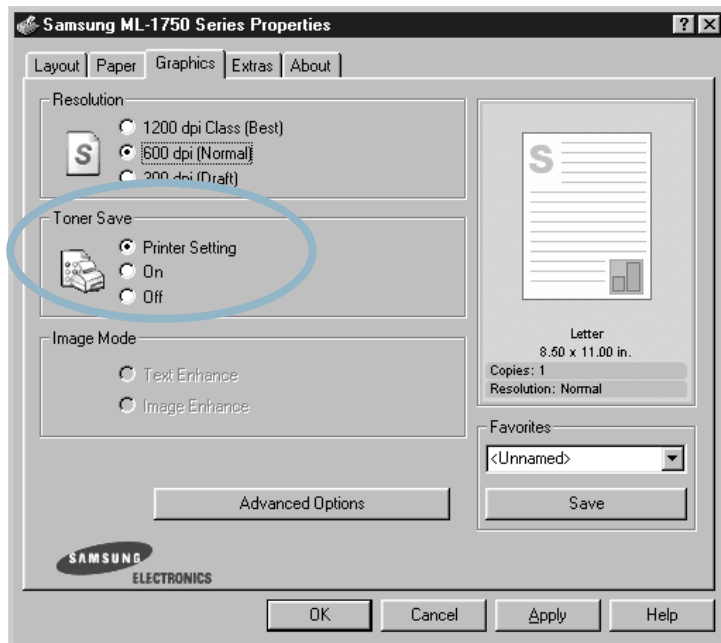

- 3 Click **OK**.

Printing Multiple Pages on One Sheet of Paper (N-Up Printing)

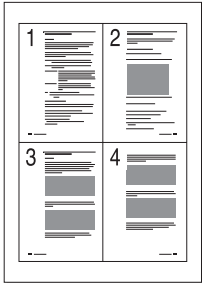

You can select the number of pages to print on a single sheet of paper. To print more than one page per sheet, the pages will appear decreased in size and arranged on the sheet. You can print up to 16 pages on one sheet.

- 1 To change the print settings from your software application, access the printer properties. See page 4.2.
- 2 From the **Layout** tab, choose **Multiple Pages per Side** in the **Type** drop-down list.
- 3 Select the number of pages you want to print per sheet (1, 2, 4, 9 or 16) in the **Pages per Side** drop-down list.

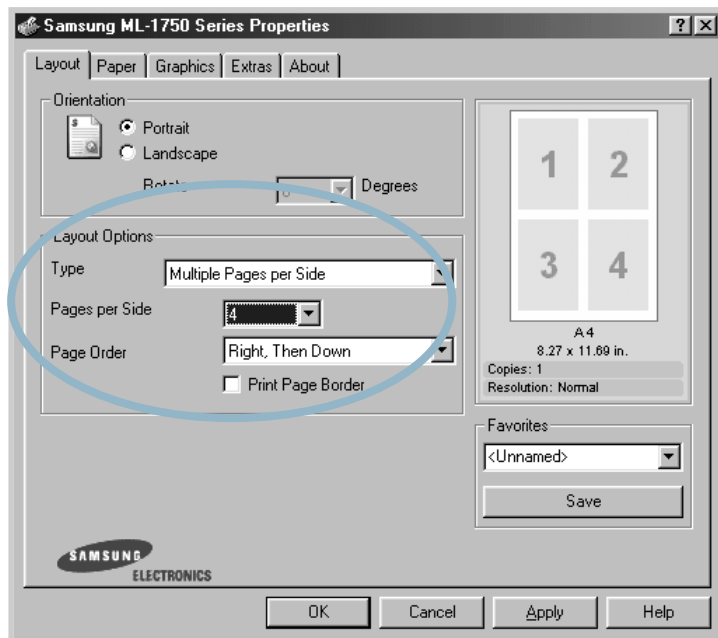

Check **Print Page Border** to print a border around each page on the sheet. **Print Page Border** is enabled only if the **Pages per Side** is 2, 4, 9, or 16.

4 Select the page order, if necessary.



Right then
Down



Down then
Right



Left then
Down



Down then
Left

5 Click the **Paper** tab, select the paper source, size and type.

6 Click **OK** and print the document.

Scaling Your Document

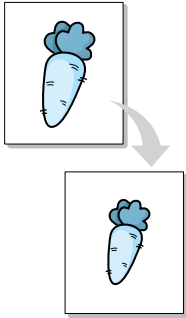

You can scale your print job on a page.

- 1 To change the print settings from your software application, access the printer properties. See page 4.2.
- 2 From the **Layout** tab, select **Reduce/Enlarge** in the **Type** drop-down list.
- 3 Enter the desired scaling rate in the **Percentage** input box.

You can also click the ▲ or ▼ button.

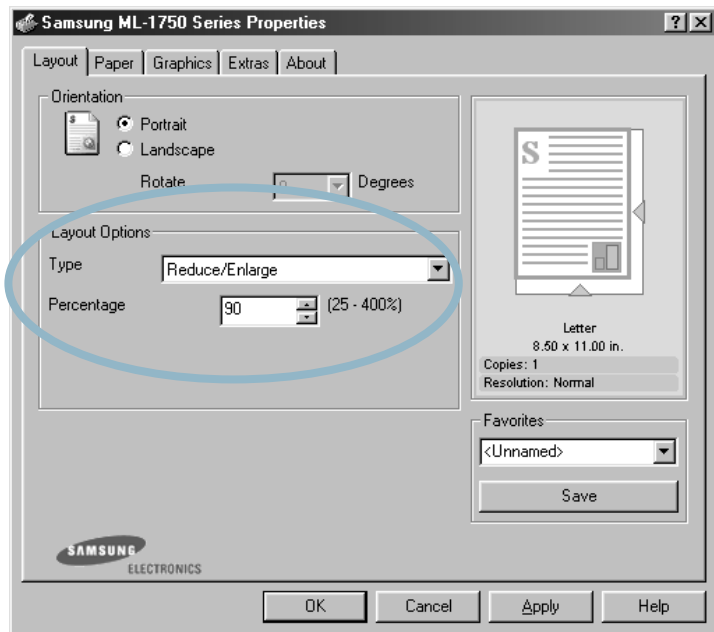

- 4 Click the **Paper** tab, select the paper source, size and type.
- 5 Click **OK** and print the document.

Fitting Your Document to a Selected Paper Size

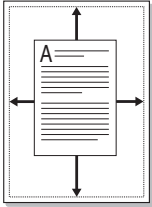

This printer feature allows you to scale your print job to any selected paper size regardless of the digital document size. This can be useful when you want to check fine details on a small document.

- 1 To change the print settings from your software application, access the printer properties. See page 4.2.
- 2 From the **Layout** tab, select **Fit to Page** in the **Type** drop-down list.
- 3 Select the correct size from the **Target Paper** drop-down list.

4

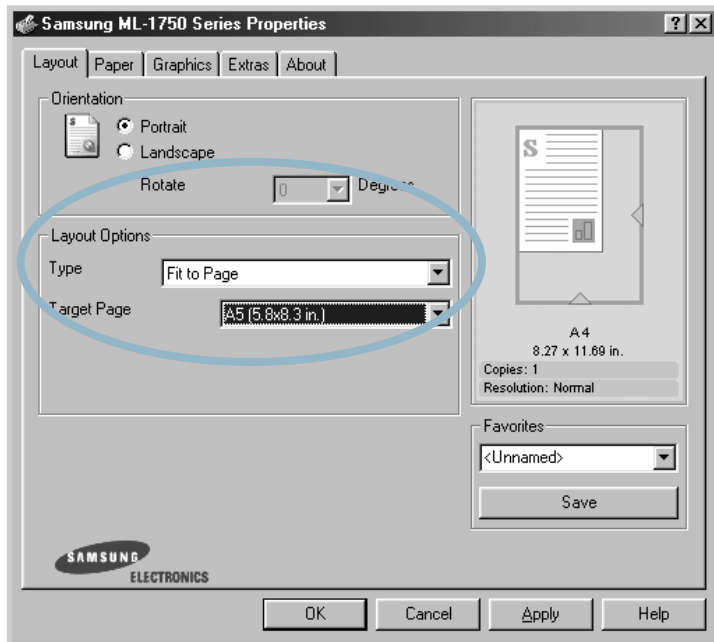

- 4 Click the **Paper** tab, select the paper source, size and type.
- 5 Click **OK** and print the document.

Printing Posters

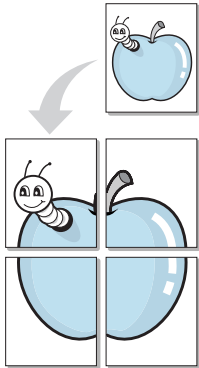

This feature allows you to print a single-page document onto 4, 9, or 16 sheets of paper, for the purpose of pasting the sheets together to form one poster-size document.

- 1 To change the print settings from your software application, access the printer properties. See page 4.2.
- 2 Click the **Layout** tab, select **Poster** in the **Type** drop-down list.

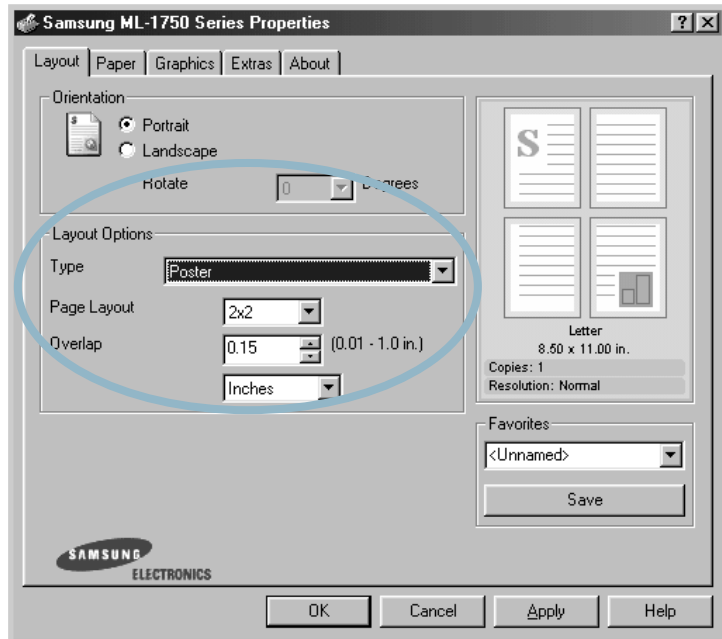

- 3 Configure the poster option:

You can select the page layout from 2x2, 3x3, or 4x4. If you select 2x2, the output will be automatically stretched to cover 4 physical pages.

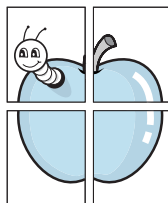

▲ 2 x 2

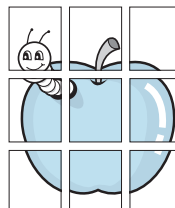

▲ 3 x 3

Specify an overlap in millimeter or inch to make it easier to reconstruct the resulting poster.

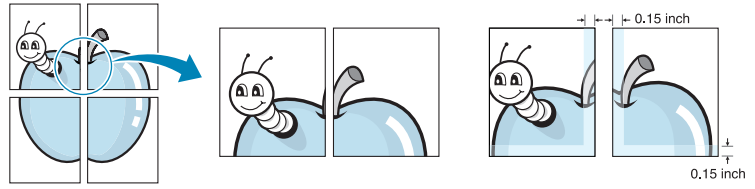

- 4 Click the **Paper** tab, select the paper source, size and type.
- 5 Click **OK** and print the document. You can complete the poster by reconstructing the results.

Setting Graphic Properties

Use the following Graphic options to adjust the print quality for your specific printing needs. See page 4.2 for more information on accessing printer properties.

Click the **Graphics** tab to display the properties shown below.

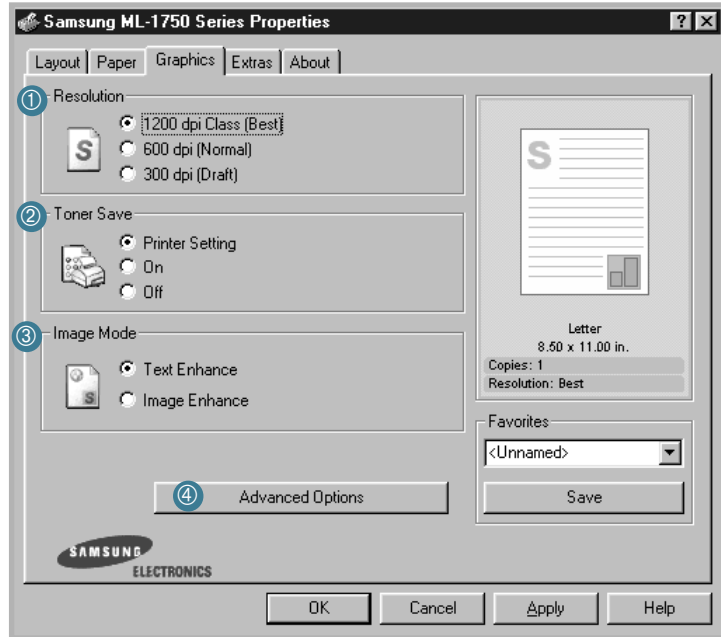

Property	Description
① Resolution	You can select the printing resolution by choosing from 1200 dpi Class (Best) , 600 dpi (Normal) or 300 dpi (Draft) . The higher the setting, the sharper the clarity of printed characters and graphics. Higher settings may increase time it takes to print a document.
② Toner Save	Selecting this option will extend the life of your toner cartridge and reduce your cost per page without a significant reduction in print quality. For detailed information about this mode, see page 4.8.

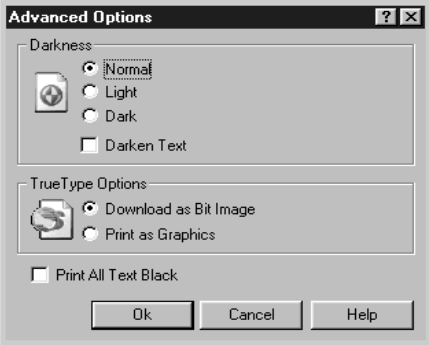
Property	Description
<p>③</p> <p>Image Mode</p>	<p>Some printed characters or images appear to have jagged or uneven edges. Set this Image Mode option to improve the print quality of your text and image, and make the characters and images appear smoother.</p> <p>The Image Mode option is only available when you select 1200 dip Class (Best) in the Resolution option.</p> <ul style="list-style-type: none"> • Text Enhance: This setting refines the print quality of characters by smoothing out jagged edges that can occur on the angles and curves of each character. • Image Enhance: This setting refines the print quality of photo images.
<p>④</p> <p>Advanced Options</p>	<p>You can set advanced settings by clicking the Advanced Options button.</p>  <p>Darkness</p> <p>Use this option to lighten or darken the image appearance in your print.</p> <ul style="list-style-type: none"> • Normal: This setting is for normal documents. • Light: This setting is for bolder line widths or darker gray-scale images. • Dark: This setting is for finer line width, higher definition in graphics, and lighter gray-scale images. <p>When the Darken Text option is checked, all text in your document is allowed to print darker than a normal document.</p>

Property	Description
<p data-bbox="440 195 471 224">④</p> <p data-bbox="430 266 563 345">Advanced Options (continued)</p>	<p data-bbox="628 185 893 214">True-Type Options</p> <p data-bbox="628 224 1200 345">This option determines what the driver tells the printer about how to image the text in your document. Select the appropriate setting according to the status of your document.</p> <ul data-bbox="628 359 1200 745" style="list-style-type: none"> <li data-bbox="628 359 1200 542">• Download as Bit Image: When this option is selected, the driver will download the font data as bitmap images. Documents with complicated fonts, such as Korean or Chinese, or various types of fonts will print faster in this setting. <li data-bbox="628 556 1200 745">• Print as Graphics: When this option is selected, the driver will download any fonts as graphics. When printing documents with high graphic content and relatively few TrueType fonts, printing performance (speed) may be enhanced in this setting. <p data-bbox="628 759 1200 909">When the Print All Text Black is checked, all text in your document is allowed to print solid black, regardless of the color it appears on the screen. When it is not checked, colored text is allowed to print in shades of gray.</p>

Printing Watermarks



The Watermark option allows you to print text over an existing document. For example, you may want to have large gray letters reading "DRAFT" or "CONFIDENTIAL" printed diagonally across the first page or all pages of a document.

There are several predefined watermarks that come with the printer, and they can be modified or you can add new ones to the list.

Using an existing Watermark

- 1 To change the print settings from your software application, access the printer properties. See page 4.2.
- 2 Click the **Extras** tab, and select the desired watermark in the **Watermark** drop-down list. You will see the selected watermark in the preview image.

4

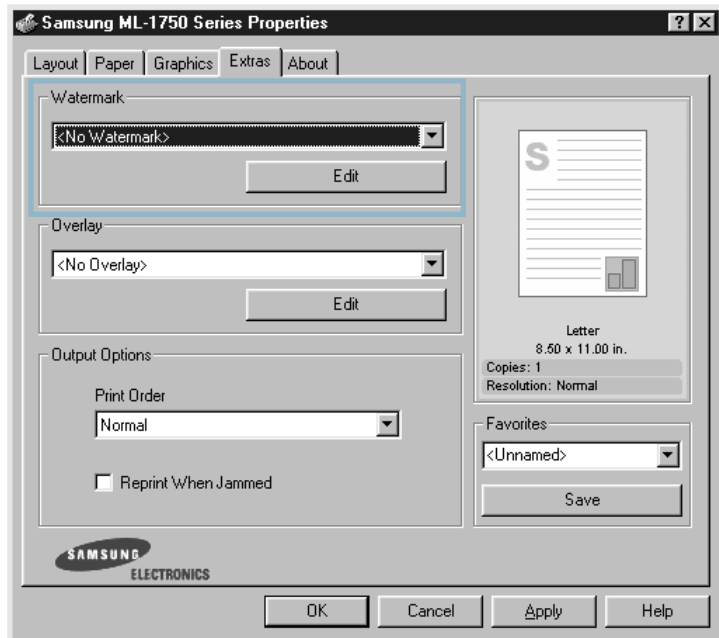

- 3 Click **OK** to start printing.

Creating a Watermark

- 1 To change the print settings from your software application, access the printer properties. See page 4.2.
- 2 Click the **Extras** tab, and click the **Edit** button in the Watermark section. The Watermarks window appears.

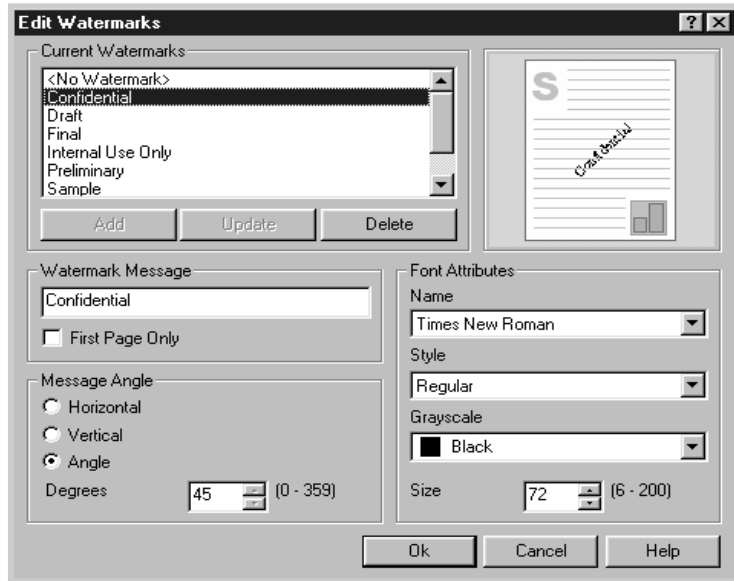

- 3 You can enter the desired text message in the **Watermark Message** box.

This will be displayed in the preview window. The preview image is provided so that you can see how the watermark will appear on the printed page.

If the **First Page Only** box is checked, the watermark will be printed on the first page only.

- 4 Select the desired watermark options.

You can select the font type and size, and color from the **Font Attributes** section, and set the angle of the watermark from the **Message Angle** section.

- 5 Click **Add** to add a new watermark to the list.
- 6 When you complete editing, click **OK** and start printing.

To stop printing the watermark, select **<No Watermark>** in the **Watermark** drop-down list.

Editing a Watermark

- 1 To change the print settings from your software application, access the printer properties. See page 4.2.
- 2 Click the **Extras** tab, and click the **Edit** button in the **Watermark** section. The Watermarks window appears.
- 3 Select the watermark you want to edit in the Current Watermarks list, and change the watermark message and the options. Refer to "Creating a Watermark" on page 4.20.
- 4 Click **Update** to save the changes.
- 5 Click **OK**.

Deleting a Watermark

- 1 To change the print settings from your software application, access the printer properties. See page 4.2.
- 2 From the **Extras** tab, click the **Edit** button in the Watermark section.
- 3 Select the watermark you want to delete in the **Current Watermarks** list, and click **Delete**.
- 4 Click **OK**.

Printing Overlays

What is an Overlay?

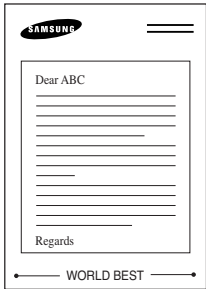

An overlay is text and/or images stored in the computer hard disk drive(HDD) as a special file format that can be printed on any document. Overlays are often used to take the place of preprinted forms and letterhead paper. Rather than using preprinted letterhead, you can create an overlay containing the exact same information that is currently on your letterhead. To print a letter with your company's letterhead, you do not need to load preprinted letterhead paper in the printer. You need only tell the printer to print the letterhead overlay on your document.

Creating a New Page Overlay

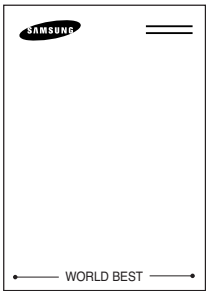

To use a page overlay, you must create a new page overlay containing your logo or image.

- 1 Create or open a document containing text or an image for use in a new page overlay. Position the items exactly as you wish them to appear when printed as an overlay. If needed, save the file for later use.
- 2 To change the print settings from your software application, access the printer properties. See page 4.2.
- 3 Click the **Extras** tab, and click **Edit** button in the **Overlay** section.

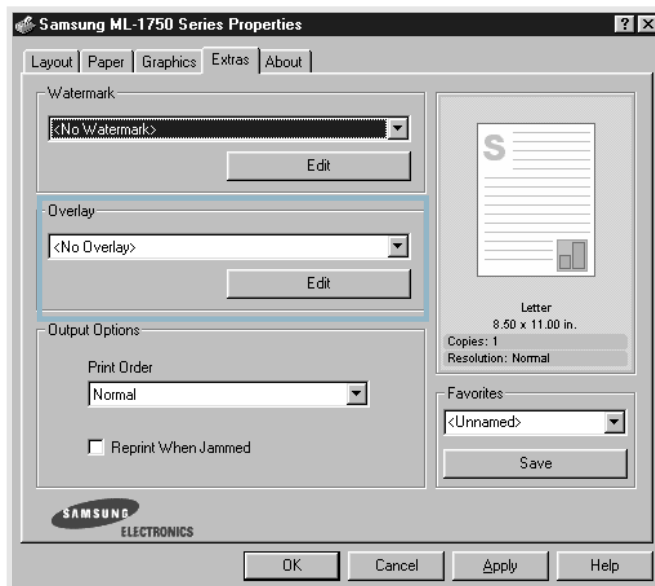

- 4 In the Overlays window, click **Create Overlay**.

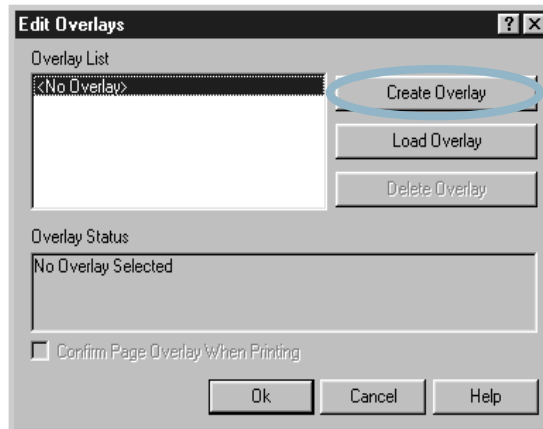

- 5 In the Create Overlay window, type a name of up to eight characters in the **File name** box. Select the destination path, if necessary. (The default is C:\Formover).

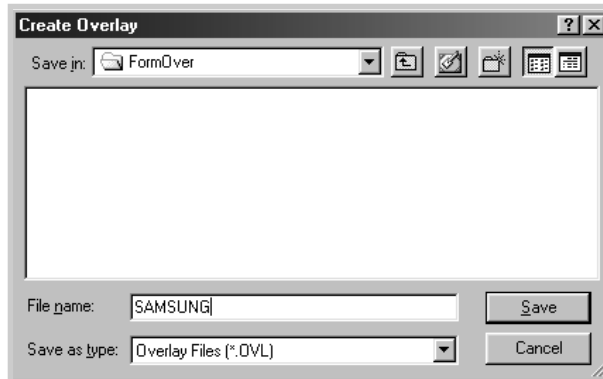

- 6 Click **Save**. You will see the name in the **Overlay List**.
- 7 Click **OK** or **Yes** until you complete creating.

The file is not printed out. Instead it will be stored on your computer HDD disk.



Note: The overlay document size must be the same as documents you will print with the overlay. Do not create an overlay with a watermark.

Using a Page Overlay

After an overlay has been created, it is ready to be printed with your document. To print an overlay with a document:

- 1 Create or open the document you want to print.
- 2 To change the print settings from your software application, access the printer properties. See page 4.2.
- 3 Click the **Extras** tab.
- 4 Select the desired overlay from the **Overlay** drop-down list box.
- 5 If the desired overlay file does not appear in the **Overlay** list, click **Edit** button and **Load Overlay**, and select the overlay file.

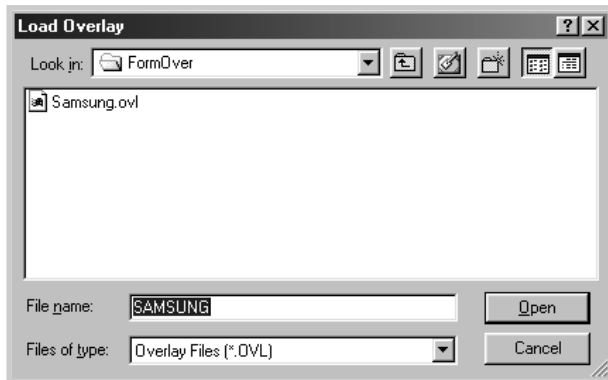

If you have stored the overlay file you want to use into an external source, you can also load the file when you access the Load Overlay window.

After you select the file, click **Open**. The file is now shown in the **Overlay List** box and is available for printing. Select the overlay from the **Overlay List** box.

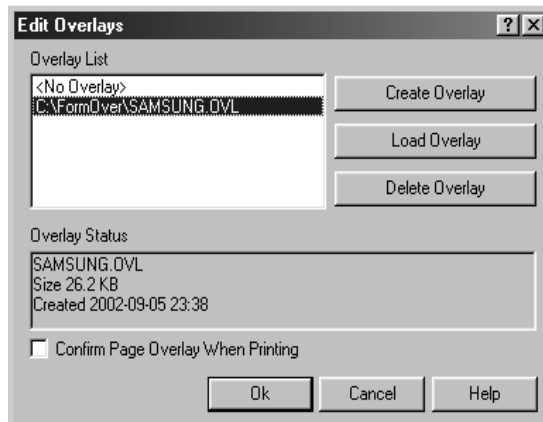

- 6 If necessary, click **Confirm page Overlay When Printing**. If this box is checked, a message window will appear each time you submit a document for printing, asking you to confirm your wish to print an overlay on your document.

Answering **Yes** to the window means that the selected overlay will be printed with your document. Answering **No** to the window cancels overlay printing.

If this box is empty and an overlay has been selected, the overlay will be automatically printed with your document.

- 7 Click **OK** or **Yes** until the printing starts.

The selected overlay will be downloaded with your print job and printed on your document.



Note: The resolution of the overlay document must be the same as that of the document you will print with the overlay.

Deleting a Page Overlay

You can delete page overlays that are no longer used.

- 1 In the printer properties window, click the **Extras** tab.
- 2 Click **Edit** in the **Overlay** section.
- 3 Select the overlay you want to delete from the **Overlay List** box.
- 4 Click **Delete Overlay**.
- 5 Click **OK** until you exit the Print window.

Using the Status Monitor

If you installed the Status Monitor software, you can check the current status of the printer whenever you want. If an error occurs in your printer, the Status Monitor window appears, showing the error.



Note: The Status Monitor program can be used only if you connect the printer to your computer with the USB cable.

Opening the Status Monitor

- 1 Double click the Status monitor icon on the Windows task bar.

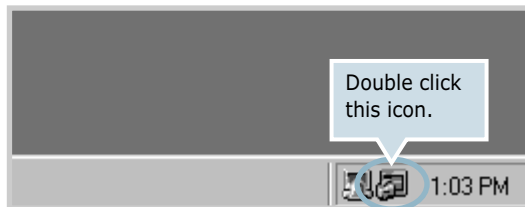

Or, select **Programs** from **Start**, **Samsung ML-1750 Series**, and **Samsung Printer Status Monitor**.

- 2 The Samsung ML-1750 Series Status monitor window appears.

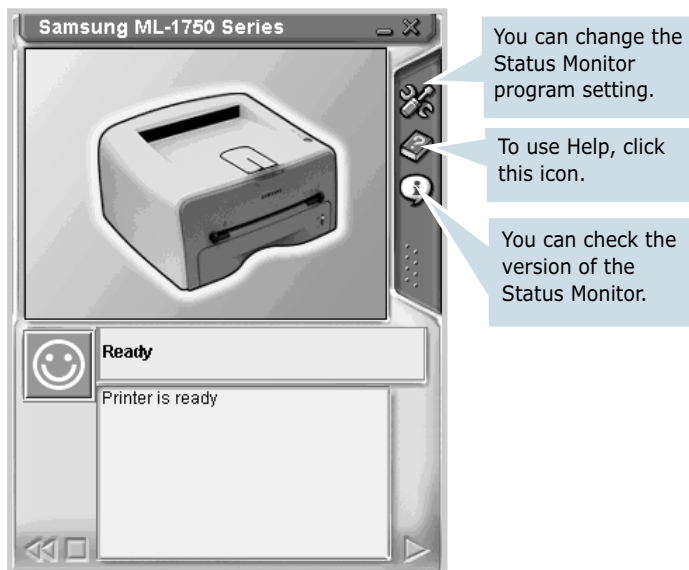

Changing the Status Monitor Program Setting

From the Status Monitor window if you click the configuration icon , you can see the following window.

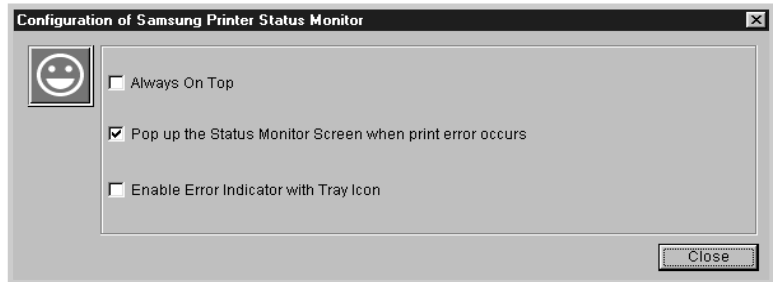

- **Always On Top** always shows the Status monitor window on the top of the window regardless of other open programs.
- **Pop up the Status Monitor Screen when print error occurs** shows the Status monitor window when an error occurs in the printer.
- **Enable Error Indicator with Tray icon** shows the blinking tray icon which indicates an error occurs in your printer.



Note: When the Status monitor window appears to indicate an error, you can see the corresponding solution.

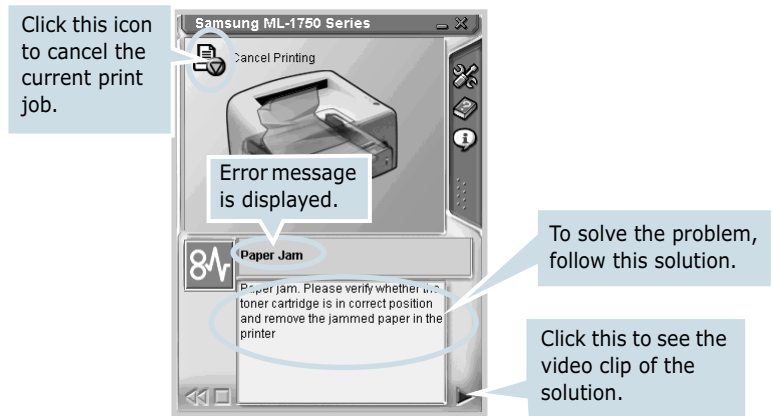

Setting Up Locally Shared Printer

You can connect the printer directly to a selected computer, which is called "host computer", on the network. The printer can be shared by other users on the network through a Windows 9x, Me, 2000, XP or NT 4.0 network printer connection.

Windows 9x/Me

Setting Up Host Computer

- 1 Start Windows.
- 2 From the **Start** menu, select **Control Panel**, and double-click on the **Network** icon.
- 3 Check the **File and Print Sharing** box, and click **OK**.
- 4 Click **Start** and select **Printers** from **Settings**, and double-click your printer name.
- 5 Select **Properties** in the **Printer** menu.
- 6 Click the **Sharing** tab, and check the **Shared As** box. Fill in the **Shared Name** field, and then click **OK**.

Setting Up Client PC

- 1 Right-click **Start**, and select **Explorer**.
- 2 Open your network folder in the left column.
- 3 Right-click the shared name, and select **Capture Printer Port**.
- 4 Select the port you want, check the **Reconnect at log on** box, and then click **OK**.
- 5 From the **Start** menu, select **Settings** and **Printers**.
- 6 Double-click your printer icon.
- 7 From the **Printer** menu, select **Properties**.
- 8 Press the **Details** tab, select the printer port, and click **OK**.

Windows NT/2000/XP

Setting Up Host Computer

- 1 Start Windows.
- 2 From the **Start** menu, select **Settings** and **Printers**.
(Windows NT/2000)
From the **Start** menu, select **Printers and Faxes**.
(Windows XP)
- 3 Double-click your printer icon.
- 4 From the **Printer** menu, select **Sharing**.
- 5 Check the **Shared** box. (Windows NT)
Check the **Shared As** box. (Windows 2000)
Check the **Share this printer** box. (Windows XP)

Fill in the **Share Name** field, and then click **OK**.
(Windows NT)
Fill in the **Shared Name** field, and then click **OK**.
(Windows 2000/XP)

4

Setting Up Client PC

- 1 Right-click **Start**, and select **Explorer**.
- 2 Open your network folder in the left column.
- 3 Click the shared name.
- 4 From the **Start** menu, select **Settings** and **Printers**.
(Windows NT/2000)
From the **Start** menu, select **Printers and Faxes**.
(Windows XP)
- 5 Double-click your printer icon.
- 6 From the **Printer** menu, select **Properties**.
- 7 Press the **Ports** tab, and click **Add Port**.

- 8 Select **Local Port**, and click **New Port**.
- 9 Fill in the **Enter a port name** field, and enter the shared name.
- 10 Click **OK**, and click **Close**.
- 11 Click **OK**. (Windows NT)
Click **Apply**, and click **OK**. (Windows 2000/XP)



5

Maintaining Your Printer

This chapter provides suggestions for maintaining the toner cartridge and the printer.

This chapter includes:

- **Maintaining the Toner Cartridge**
- **Cleaning the Printer**
- **Consumables and Replacement Parts**

Maintaining the Toner Cartridge

Toner cartridge storage

To get the maximum results from the toner cartridge, keep the following guidelines in mind.

- Do not remove the toner cartridge from its package until ready for use.
- Do not refill the toner cartridge. **The printer warranty does not cover damage caused by using a refilled cartridge.**
- Store toner cartridges in the same environment as the printer.
- To prevent damage to the toner cartridge, do not expose it to light for more than a few minute.

Toner cartridge life expectancy

The life of the toner cartridge depends on the amount of toner that print jobs require. When printing text at 5% coverage, a new toner cartridge lasts an average of 3,000 pages. (The original toner cartridge supplied with the printer lasts an average of 1,000 pages.)

Saving toner

To save toner, press the **Cancel** button on the printer control panel. The button will be lit. You can also enable the Toner Save in the printer properties. Refer to "Using the Toner Save Mode" on page 4.8. Selecting this option will extend the life of the toner cartridge and reduce your cost per page, but will reduce the print quality.

Redistributing Toner

When toner is low, faded or light areas may appear on a printed page. You may be able to temporarily improve the print quality by redistributing the toner. The following procedures may allow you to finish the current print job before replacing the toner cartridge.

- 1 Grasp the front cover and pull it toward you to open.

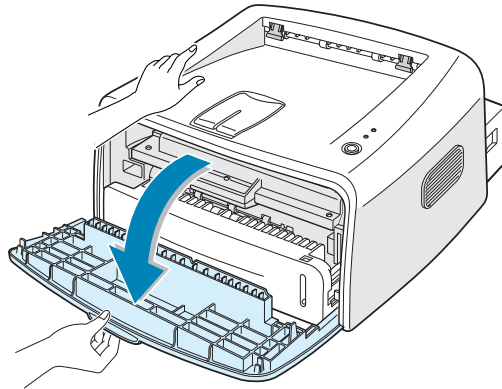

- 2 Push the toner cartridge down and remove it from the printer.

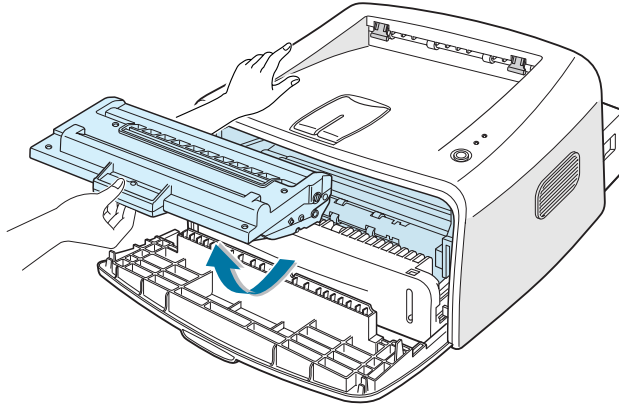

Cautions:

- Avoid reaching too far into the printer. The fusing area may be hot.
- To prevent damage to the toner cartridge, do not expose it to light for more than a few minutes.

- 3 Gently shake the toner cartridge from side to side five or six times to redistribute the toner.

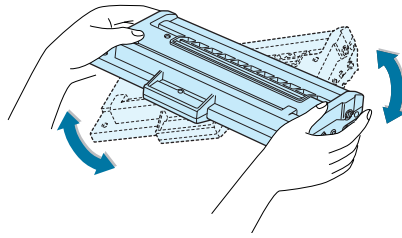

Note: If the toner gets on your clothing, wipe it off with a dry cloth and wash clothing in cold water. Hot water sets toner into fabric.

- 4 Reinsert the toner cartridge into the printer. Ensure that the toner cartridge snaps into place.

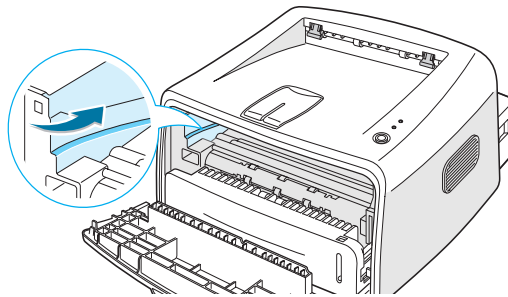

- 5 Close the front cover. Make sure that the cover is securely closed. If it is not firmly closed, printing errors may occur when you print.

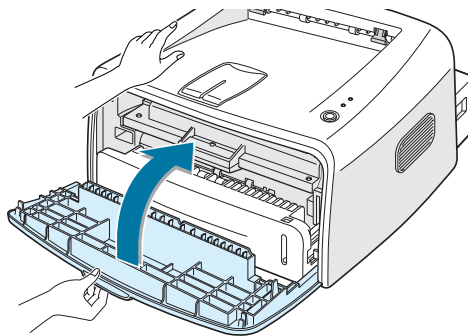

Replacing the Toner Cartridge

If the print remains light after redistributing toner (see page 5.3), replace the toner cartridge.

Remove the old cartridge and install a new toner cartridge. See "Installing the Toner Cartridge" on page 2.4.

Cleaning the Printer

To maintain the print quality, follow the cleaning procedures below each time the toner cartridge is replaced or if print quality problems occur.



Note: While cleaning the inside of the printer, be careful not to touch the transfer roller (located underneath the toner cartridge). Oil from your fingers can cause print quality problems.



Caution: Cleaning the cabinet of the printer with surfactants containing large amounts of alcohol, solvent or other strong substances can discolor or crack the cabinet.

Cleaning the Outside

Clean the cabinet of the printer with a soft, lint-free cloth. You can dampen the cloth slightly with water, but be careful not to be let any water drip onto the printer or inside of it.

5

Cleaning the Inside

During the printing process, paper, toner, and dust particles can accumulate inside the printer. This buildup can cause print quality problems, such as toner specs or smearing. Cleaning the inside of the printer will eliminate or reduce these problems.

Cleaning inside the printer

- 1 Turn the printer off and unplug the power cord, then wait for the printer to cool.
- 2 Open the front cover. Push down the toner cartridge and remove it from the printer.

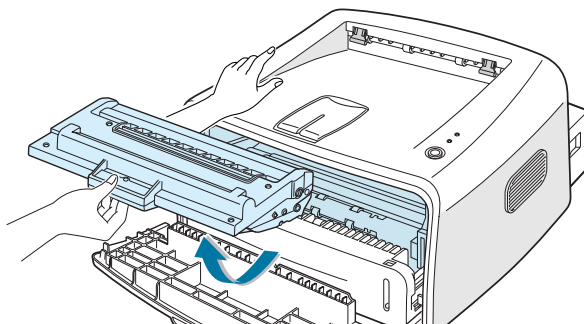

- 3 With a dry, lint-free cloth, wipe away any dust and spilled toner from the toner cartridge area and the toner cartridge cavity.

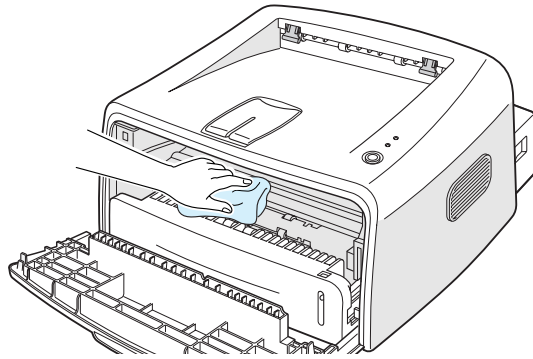

Note: To prevent damage to the toner cartridge, do not expose it to light for more than a few minutes. Cover it with a piece of paper, if necessary. Also, do not touch the black transfer roller inside the printer.

- 4 Reinsert the toner cartridge and close the cover. Make sure that the cover is securely closed. If it is not firmly closed, printing errors may occur when you print.

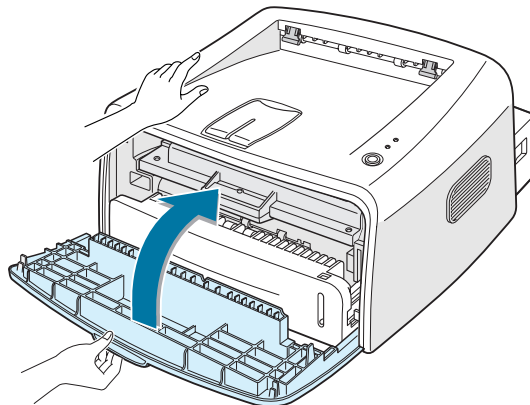

- 5 Plug in the power cord, and turn the printer on.

Printing a cleaning sheet

If you are experiencing blurred, faded or smeared printouts. Printing a cleaning sheet cleans the drum inside the toner cartridge. This process will produce a page with toner debris, which should be discarded.

- 1 Ensure that the printer is turned on and in the Ready mode with paper loaded in the tray.
- 2 Press and hold down the **Cancel** button on the control panel for about 10 seconds.

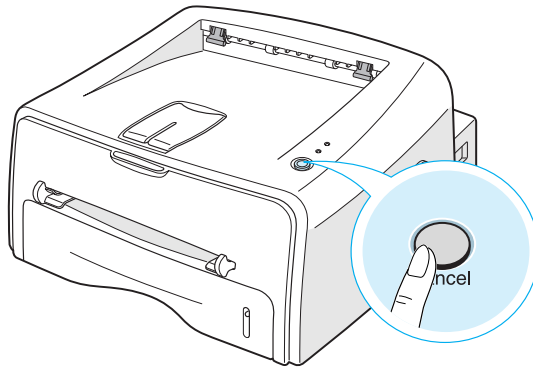

5

- 3 Your printer automatically picks up a sheet of paper from the tray and prints out a cleaning sheet with dust or toner particles on it.



Note: The cartridge cleaning process takes some time. To stop printing, turn the power off.

Consumables and Replacement Parts

From time to time, you will need to replace the roller and fuser unit to maintain top performance and avoid print quality problems and paper feed problems resulting from worn parts.

The following items should be replaced after you have printed a specified number of pages. See the table below.

Items	Yield (Average)
Paper Feeding Roller	60,000
Transfer Roller	60,000
Pick-up roller	60,000
Fuser Unit	60,000

To purchase the consumables and replacement parts, contact Samsung dealer or the place where you bought your product. We strongly recommend that items be installed by a trained service personnel.



6

Solving Problems

This chapter provides helpful information for what to do if you encounter an error while using your printer.

This chapter includes:

- **Troubleshooting Checklist**
- **Solving General Printing Problems**
- **Clearing Paper Jams**
- **Solving Print Quality Problems**
- **Troubleshooting Error Messages**
- **Common Windows Problems**
- **Common Linux Problems**
- **Common DOS problem**

Troubleshooting Checklist

If the printer is not working properly, consult the following checklist. If the printer does not pass a step, follow the corresponding troubleshooting suggestions.

Check	Solution
Check the power cord and the power switch.	Check the power source by plugging into another outlet.
Make sure that the On Line/Error LED is on.	In the Ready mode, the On Line/Error LED lights green. If the On Line/Error LED lights red or blinks, go to "Troubleshooting Error Messages" on page 6.18.
Press and hold the Cancel button to print a demo page.	<ul style="list-style-type: none">• If a demo page does not print, check the paper supply in the input tray.• If the paper jams in the printer, go to "Clearing Paper Jams" on page 6.7.
Check the demo page to see if it is printed correctly.	If there is a print quality problem, go to "Solving Print Quality Problems" on page 6.12.
Print a short document from a software application to verify that the computer and printer are connected and are communicating correctly.	<ul style="list-style-type: none">• If the page does not print, check the cable connection between the printer and the computer.• Check the print queue or print spooler to see if the printer has been paused.• Check the software application to ensure you are using the proper printer driver and communication port. If the page is interrupted during printing, go to "Solving General Printing Problems" on page 6.3.
If completing the checklist does not resolve the printer problem, check the following troubleshooting sections.	<ul style="list-style-type: none">• "Solving General Printing Problems" on page 6.3.• "Troubleshooting Error Messages" on page 6.18.• "Common Windows Problems" on page 6.19.• "Common Linux Problems" on page 6.20.• "Common DOS problem" on page 6.23.

Solving General Printing Problems

For problems with the operation of your printer, refer to the table for suggested solutions.

Problem	Possible Cause	Solution
The Printer does not print	The printer is not receiving power.	Check the power cord connections. Check the power switch and the power source.
	The printer is not selected as the default printer.	Select Samsung ML-1750 Series in the Printer folder in Windows as your default printer.
	Check the printer for the following:	<ul style="list-style-type: none"> • The printer cover is not closed. • Paper is jammed. • No paper is loaded. • The toner cartridge is not installed. If a printer system error occurs, contact your service representative.
	The printer may be in Manual Feed mode.	Add paper to the manual feeder and press the Cancel button on the printer's control panel to begin printing.
	The connection cable between the computer and the printer is not connected properly.	Disconnect the printer cable and reconnect it.
	The connection cable between the computer and the printer is defective.	If possible, attach the cable to another computer that is working properly and print a job. You can also try using a different printer cable.
	The port setting is incorrect.	Check the Windows printer setting to make sure that the print job is sent to the correct port (for example, LTP1). If the computer has more than one port, make sure that the printer is attached to the correct one.
	The printer may be configured incorrectly.	Check the printer properties to ensure that all print settings are correct.

Problem	Possible Cause	Solution
The printer does not print. (continued)	The printer driver may be incorrectly installed.	Reinstall the printer driver; see page 2.16. Try printing a demo page.
	The printer is malfunctioning.	Check the LEDs on the control panel to determine if the printer is indicating a system error.
Printer selects materials from the wrong paper source.	The paper source selection in the printer properties may be incorrect.	For many software applications, the paper source selection is found under the Paper tab within the printer properties. Select the correct paper source. See page 4.6.
Paper does not feed into the printer.	Paper has not been loaded correctly.	Remove paper from the tray and reload it correctly.
	There is too much paper in the tray.	Remove excess paper from the tray.
	The paper is too thick.	Use only paper that meets the specifications required by the printer.
Print job is extremely slow.	The job may be very complex.	Reduce the complexity of the page or try adjusting the print quality settings. The maximum print speed of the printer is 16(A4) or 17(Letter) pages per minute.
	If using Windows 9x/Me, the Spooling Setting may be set incorrectly.	From the Start menu, choose Settings and Printers . Right-click the Samsung ML-1750 Series printer icon, choose Properties , click the Details tab, and then choose the Spool Settings button. Select the desired spool setting.
Half the page is blank.	The page layout is too complex.	Simplify the page layout and remove any unnecessary graphics from the document.
	The page orientation setting may be incorrect.	Change the page orientation in your application.
	The paper size and the paper size settings do not match.	Ensure that the paper size in the print settings matches the paper in the tray.

Problem	Possible Cause	Solution
The paper keeps jamming.	There is too much paper in the paper tray.	Remove excess paper from the tray. If printing on special materials, use the manual feeder.
	An incorrect type of paper is being used.	Use only paper that meets the specifications required by the printer.
	An incorrect output method is being used.	Special print materials, such as thick paper, should not be printed using the top output tray (face-down). Use the rear output tray (face-up) instead.
	There may be debris inside the machine.	Open the front cover and remove the debris.
The printer prints, but the text is wrong, garbled, or incomplete.	The printer cable is loose or defective.	Disconnect the printer cable and reconnect. Try a print job that you have already printed successfully. If possible, attach the cable and printer to another computer and try a print job that you know works. Finally, try a new printer cable.
	The wrong printer driver was selected.	Check the application's printer selection menu to ensure that your printer is selected.
	The software application is malfunctioning.	Try printing a job from another application.
	The operating system is malfunctioning.	If printing from Windows (any version), exit to a DOS prompt and verify functionality with the following command: At a C:\ prompt, type Dir LPT1 , and press Enter . (This assumes you are connected to LPT1.) Exit Windows and reboot the computer. Turn the printer off and then back on again.

Problem	Possible Cause	Solution
Pages print, but are blank.	The toner cartridge is defective or out of toner.	Redistribute the toner, if necessary. See page 5.3. If necessary, replace the toner cartridge.
	The file may have blank pages.	Check the file to ensure it does not contain blank pages.
	Some parts, such as the controller or the board, may be defective.	Contact a service representative.
The illustrations print incorrectly in Adobe Illustrator.	The setting in the software application is wrong.	Print the document with selecting Download as Bit Image in the Advanced options of the Graphic properties.

ATTENTION:

If you have any printing problem after your printer prints about 60,000 pages, you must contact the customer service to replace the transfer roller.

Clearing Paper Jams

Occasionally, paper can be jammed during a print job. Some of causes include:

- The tray is loaded improperly or overfilled.
- The tray has been pulled out during a print job.
- The front cover has been opened during a print job.
- Paper that does not meet paper specifications has been used. See "Paper Specifications" on page 7.22.
- Paper that is outside of the supported size range has been used. See "Paper Specifications" on page 7.22.

If a paper jam occurs, the **On Line/Error** LED on the control panel lights red. Find and remove the jammed paper. If it is invisible, look inside the printer.



Note: Do not use tweezers or metals with a sharp end when you remove paper jams. If you do this, it may damage the metal parts inside of your machine and cause a short circuit.

In the Paper Exit Area



Note: Paper jams in this area may result in loose toner on the page. If you get any toner on your clothes, wash them in cold water as hot water will set the toner into the fabric.

- 1 If the paper jams as it exits to the output tray and a long portion of the paper is visible, pull the paper straight out.

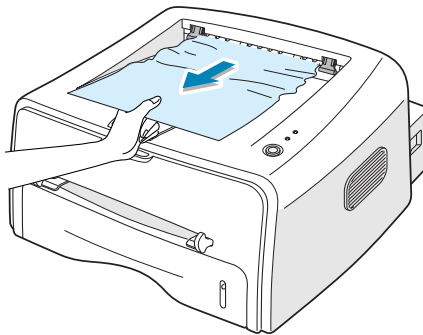

When you pull the jammed paper, if there is resistance and the paper does not move immediately, stop pulling. Continue with the next step.

- 2 Open the rear output tray.

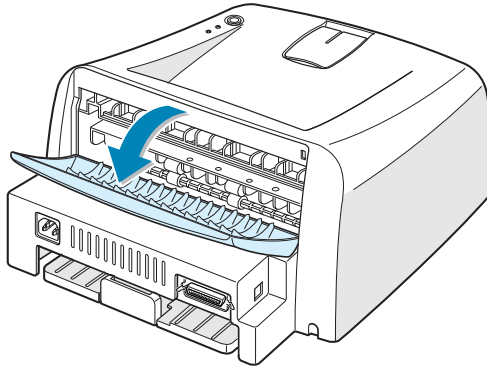

- 3 Loosen the paper if it is caught in the feed rollers. Then pull the paper gently out.

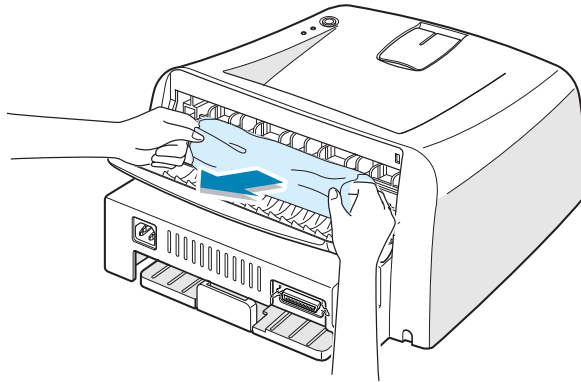

Note: Please be careful when you open the rear cover. The inside of the printer is still hot.

- 4 Close the rear output tray.

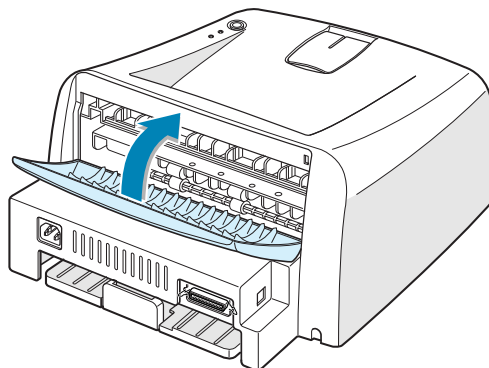

- 5 Open and close the front cover. Printing can be resumed.

In the Paper Feed Area

- 1 Slide out the tray to expose the jammed paper.

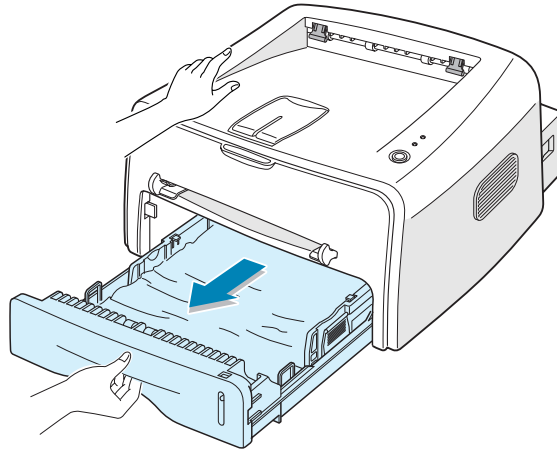

- 2 Remove any missfeed paper by pulling it out by the visible edge from the tray. Make sure that all of the paper is properly aligned in the tray.

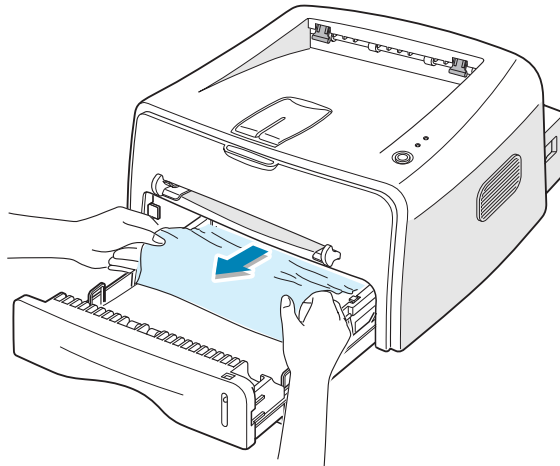

- 3 Slide the tray back into the printer.
- 4 Open and close the front cover. Printing can be resumed.

Around the Toner Cartridge

- 1 Open the front cover.

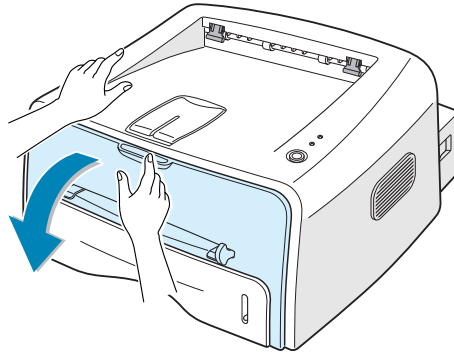

- 2 Push the toner cartridge down and remove it from the printer.

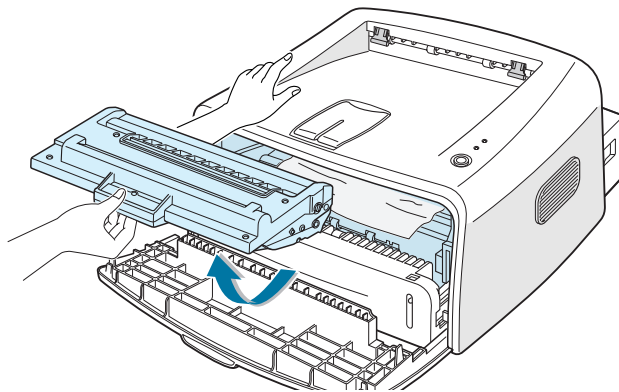

- 3 Gently pull the paper toward you.

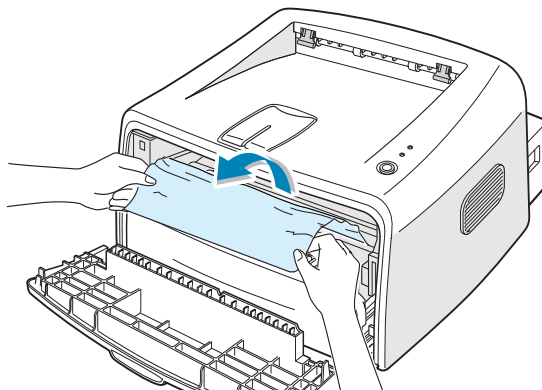

- 4 Check that there is no other paper in the printer.
- 5 Reinstall the toner cartridge, and then close the cover. Printing can be resumed.

Tips for Avoiding Paper Jams When Printing on the A5-sized Paper

If paper jams frequently occur when you print on the A5-sized paper:

- 1 Open the input tray and load paper into the tray as shown below.

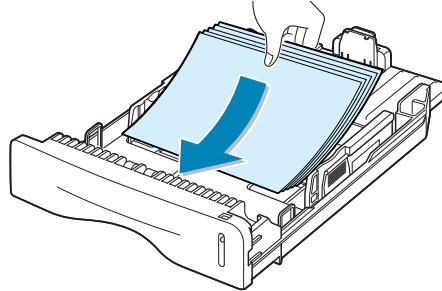

- 2 Open the Samsung ML-1750 Series Properties window, set the paper size to **A5(5.8x8.3 in.)** from the **Paper** tab.
- 3 From the **Orientation** option of the **Layout** tab, set the **Rotate** option to **90°**.

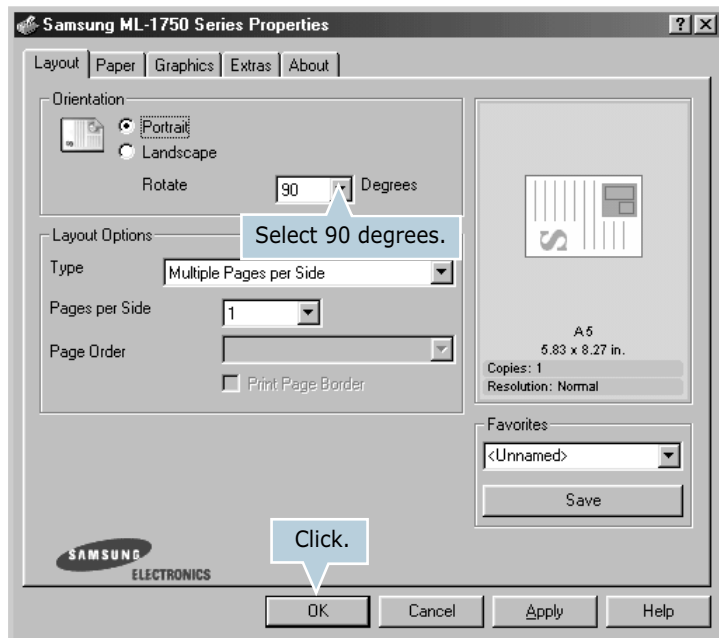

- 4 Click **OK** to start printing.

Tips for Avoiding Paper Jams

By selecting the correct paper types, most paper jams can be avoided. If a paper jam occurs, follow the steps outlined in "Clearing Paper Jams" on page 6.7.

- Follow the procedures in "Loading Paper" on page 2.6. Ensure that the adjustable guides are positioned correctly.
- Do not overload the tray. Ensure that the paper is below the paper capacity mark on the right inside of the tray.
- Do not remove the paper from the tray while printing.
- Flex, fan and straighten the paper before loading.
- Do not use creased, damp or highly curled paper.
- Do not mix paper types in the input tray.
- Use only recommended print media. See "Paper Specifications" on page 7.22.
- Ensure that the recommended print side is facing down when loading paper into the input tray.

Solving Print Quality Problems

Print Quality Checklist

Print quality problems can be resolved by following the checklist below.

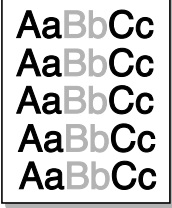
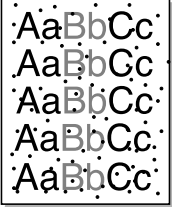
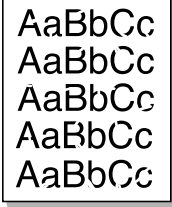

- Redistribute toner in the toner cartridge (see page 5.3).
- Clean the inside of the printer (see page 5.5).
- Adjust the print resolution from the printer properties (see page 4.16).
- Ensure that Toner Save Mode is off (see page 4.8).
- Clear general printing problems (see page 6.3).
- Install a new toner cartridge, and check the print quality (see page 2.4).

Solving Print Quality Problems

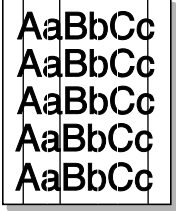
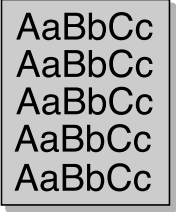
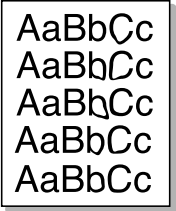
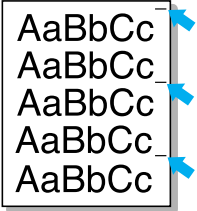
Problem	Solution
<p>Light or faded print</p> 	<p>If a vertical white streak or faded area appears on the page:</p> <ul style="list-style-type: none"> • The toner supply is low. You may be able to temporarily extend the toner cartridge life. See "Redistributing Toner" on page 5.3. If this does not improve the print quality, install a new toner cartridge. • The paper may not meet paper specifications (for example, the paper is too moist or too rough). See "Paper Specifications" on page 7.22. • If the entire page is light, the print resolution setting is too light or Toner Save Mode is on. Adjust the print resolution and Toner Save Mode in the printer properties. See page 4.16 and 4.8 respectively. • A combination of faded or smeared defects may indicate that the toner cartridge needs cleaning. See "Cleaning the Inside" on page 5.5.
<p>Toner specs</p> 	<ul style="list-style-type: none"> • The paper may not meet specifications (for example, the paper is too moist or too rough). See "Paper Specifications" on page 7.22. • The transfer roller may be dirty. See "Cleaning the Inside" on page 5.5. • The paper path may need cleaning. See "Cleaning the Inside" on page 5.5.
<p>Dropouts</p> 	<p>If faded areas, generally rounded, occur randomly on the page:</p> <ul style="list-style-type: none"> • A single sheet of paper may be defective. Try reprinting the job. • The moisture content of the paper is uneven or the paper has moist spots on its surface. Try a different brand of paper. See "Paper Specifications" on page 7.22. • The paper lot is bad. The manufacturing processes can cause some areas to reject toner. Try a different kind or brand of paper. • The toner cartridge may be defective. See "Vertical repetitive defects" on the next page. • If these steps do not correct the problems, contact a service representative.

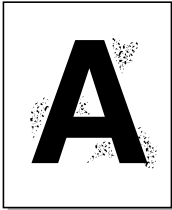
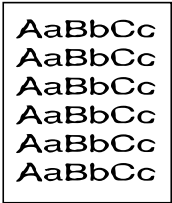
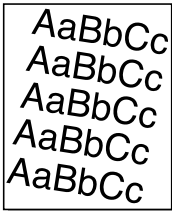
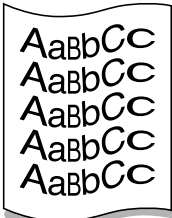
Problem	Solution
<p>Vertical lines</p> 	<p>If black vertical streaks appear on the page:</p> <ul style="list-style-type: none"> • The drum inside the toner cartridge has probably been scratched. Install a new toner cartridge.
<p>Gray background</p> 	<p>If the amount of background shading becomes unacceptable, the procedures below may fix the problem.</p> <ul style="list-style-type: none"> • Change to a lighter weight pages. See "Paper Specifications" on page 7.22. • Check the printer's environment; very dry (low humidity) or high humidity (higher than 80% RH) conditions can increase the amount of background shading. • Remove the old toner cartridge and install a new one. See "Installing the Toner Cartridge" on page 2.4.
<p>Toner smear</p> 	<ul style="list-style-type: none"> • Clean the inside of the printer. See "Cleaning the Inside" on page 5.5. • Check the paper type and quality. See "Paper Specifications" on page 7.22. • Remove the toner cartridge and install a new one. See "Installing the Toner Cartridge" on page 2.4.
<p>Vertical repetitive defects</p> 	<p>If marks repeatedly appear on the printed side of the page at even intervals:</p> <ul style="list-style-type: none"> • The toner cartridge may be damaged. If a repetitive mark occurs on the page, print a cleaning sheet several times to clean the cartridge (see page 5.5). After the printout, if you still have the same problems, install a new toner cartridge. See "Installing the Toner Cartridge" on page 2.4. • Parts of the printer may have toner on them. If the defects occur on the back of the page, the problem will likely correct itself after a few more pages. • The fusing assembly may be damaged. Contact a service representative.

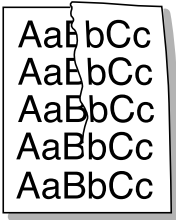
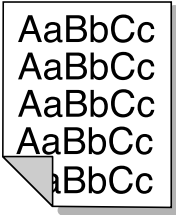
Problem	Solution
<p>Background scatter</p> 	<p>Background scatter results from bits of toner distributed on the printed page.</p> <ul style="list-style-type: none"> • The paper may be too damp. Try printing with a different batch of paper. Do not open packages of paper until necessary so that the paper does not absorb too much moisture. • If background scatter occurs on an envelope, change the printing layout to avoid printing over areas that have overlapping seams on the reverse side. Printing on seams can cause problems. • If background scatter covers the entire surface area of a printed page, adjust the print resolution through your software application or the printer properties.
<p>Misformed characters</p> 	<ul style="list-style-type: none"> • If characters are improperly formed and producing hollow images, the paper stock may be too slick. Try a different paper. See "Paper Specifications" on page 7.22. • If characters are improperly formed and producing a wavy effect, the scanner unit may need service. Verify that it also occurs on a demo page by pressing the Cancel button on the control panel when the printer is ready. For service, contact a service representative.
<p>Page skew</p> 	<ul style="list-style-type: none"> • Check the paper type and quality. See "Paper Specifications" on page 7.22. • Ensure that the paper or other material is loaded correctly and the guides are not too tight or too loose against the paper stack.
<p>Curl or wave</p> 	<ul style="list-style-type: none"> • Check the paper type and quality. Both high temperature and humidity can cause paper curl. See "Paper Specifications" on page 7.22. • Turn over the stack of paper in the input tray. Also try rotating the paper 180° in the input tray. • Push the output lever and try printing to the face up output slot.

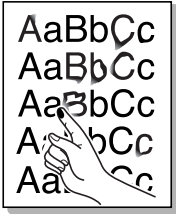

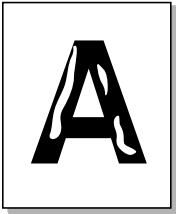
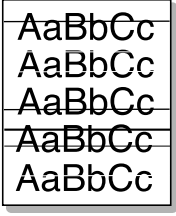
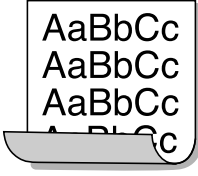
Problem	Solution
<p>Wrinkles or creases</p> 	<p>Ensure that the paper is loaded properly.</p> <ul style="list-style-type: none"> • Check the paper type and quality. See "Paper Specifications" on page 7.22. • Open the rear cover and try printing to the rear output tray (face-up). • Turn over the stack of paper in the input tray. Also try rotating the paper 180° in the feeder.
<p>Back of printouts are dirty</p> 	<ul style="list-style-type: none"> • The transfer roller may be dirty. See "Cleaning the Inside" on page 5.5. • Check for leaking toner. Clean the inside of the printer.
<p>Black pages</p> 	<ul style="list-style-type: none"> • The toner cartridge may not be installed properly. Remove the cartridge and reinsert. • The toner cartridge may be defective and need replacing. Install a new toner cartridge. • The printer may require repair. Contact a service representative.
<p>Loose toner</p> 	<p>Clean the inside of the printer.</p> <ul style="list-style-type: none"> • Check the paper type and quality. See "Paper Specifications" on page 7.22. • Install a new toner cartridge. • If the problem persists, the printer may require repair. Contact a service representative.

Problem	Solution
<p>Character Voids</p> 	<p>Character voids are white areas within the parts of characters that should be solid black:</p> <ul style="list-style-type: none"> • If you are using transparencies, try another type of transparency. Because of the composition of the transparency, some character voids are normal. • You may be printing on the wrong surface on the paper. Remove the paper and turn it around. • The paper may not meet paper specifications. See “Paper Specifications” on page 7.22.
<p>Horizontal stripes</p> 	<p>If horizontally aligned black streaks or smears appear:</p> <ul style="list-style-type: none"> • The toner cartridge may be installed improperly. Remove the cartridge and reinsert. • The toner cartridge may be defective. Install a new toner cartridge. See “Installing the Toner Cartridge” on page 2.4. • If the problem persists, the printer may require repair. Contact a service representative.
<p>Curl</p> 	<p>If the printed paper is curl or paper does not feed into the printer:</p> <ul style="list-style-type: none"> • Turn over the stack of paper in the input tray. Also try rotating the paper 180° in the input tray.



Troubleshooting Error Messages

When the printer experiences an error, the control panel will indicate an error message with the indicator lights. Find the light pattern below that matches the printer light pattern and follow the solutions to clear the error.

LED status legend

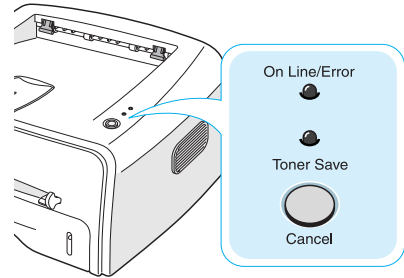
-  symbol for "light off"
-  symbol for "light on"
-  symbol for "light blinking"



LED pattern	Possible Problems and Solutions
<p>On Line/Error</p>  <p>Toner Save</p>	<p>Your system has some problems. If this problem occurs, contact your service representative.</p>
<p>On Line/Error</p>  <p>Toner Save</p> <p>On Line/Error LED lights red</p>	<ul style="list-style-type: none"> • Paper jam occurs. To solve the problem, see "Clearing Paper Jams" on page 6.7. • The front cover is open. Close the front cover. • The toner cartridge is empty. Remove the old toner cartridge and install a new one. See "Installing the Toner Cartridge" on page 2.4.
<p>On Line/Error</p>  <p>Toner Save</p>	<ul style="list-style-type: none"> • You pressed the Cancel button while the printer is receiving data. • In Manual Feed mode, there is no paper in the Manual Feeder. Load paper into the Manual Feeder. • If the printer is receiving data, the On Line/Error LED slowly blinks green. • If the printer is printing the received data, the On Line/Error LED blinks green fast.

Common Windows Problems

Problem	Possible Cause and Solution
"File in Use" message appears during installation.	Exit all software applications. Remove all software from the StartUp Group, then restart Windows. Reinstall the printer software.
"Error Writing to LPTx" message appears.	<ul style="list-style-type: none">• Ensure that the cables are connected correctly and the printer is on.• If bi-directional communication is not turned on in the driver, it will also cause this message.
"General Protection Fault", "Exception OE", "Spool32", or "Illegal Operation" messages appear.	Close all other applications, reboot Windows, and try printing again.

Note: Refer to Microsoft Windows 9x, Me, NT 4.0, 2000 or XP User's Guide that came with your PC for further information on Windows error messages.

Common Linux Problems

Problem	Possible Cause and Solution
I can't change settings in the configuration tool.	You need to have administrator privileges to be able to affect global settings.
I am using the KDE desktop but the configuration tool and LLPR won't start.	Maybe you do not have the GTK libraries installed. These usually come with most Linux distributions, but you may have to install them manually. Refer to your distribution's installation manual for more details about installing additional packages.
I just installed this package but can't find entries in the KDE/Gnome menus.	Some versions of the KDE or GNOME desktop environments may require that you restart your session for the changes to take effect.
I get a "Some options are not selected" error message while editing the printer settings.	Some printers have conflicting settings, meaning that some settings for two options can't be selected at the same time. When you change a setting and the Printer Package detects such a conflict, the conflicting option is changed to a "No Choice" value, and you have to choose an option that does not conflict before being able to submit the changes.
I can't make a printer the system default.	<ul style="list-style-type: none">• In some conditions, it may not be possible to change the default queue. This happens with some variants of LPRng, especially on recent RedHat systems that use the 'printconf' database of queues.• When using printconf, the /etc/printcap file is automatically refreshed from the database of printers managed by the system (usually through the 'printtool' command), and the queues in /etc/printcap.local are appended to the resulting file. since the default queue in LPRng is defined as the first queue in /etc/printcap, therefore it is not possible for the Samsung Printer Package to change the default when some queues have otherwise been defined using printtool.• LPD systems identify the default queue as the one named 'lp'. Thus if there is already a queue by this name, and if it doesn't have any alias, then you won't be able to change the default. To work around this, you can either delete the queue, or rename it by manually editing the /etc/printcap file.

Problem	Possible Cause and Solution
The N-up setting does not work correctly for some of my documents.	The N-up feature is achieved through post-processing of the PostScript data that is being sent to the printing system. However, such post-processing can only be adequately achieved if the PostScript data conforms to the Adobe Document Structuring Conventions. Problems may arise when using N-up and other features relying on post-processing if the document being printed isn't compliant.
I am using BSD lpr (Slackware, Debian, older distributions) and some options chosen in LLPR don't seem to take effect.	Legacy BSD lpr systems have a hard limitation on the length of the option string that can be passed to the printing system. As such, if you selected a number of different options, the length of the options may be exceeded and some of your choices won't be passed to the programs responsible for implementing them. Try to select less options that deviate from the defaults, to save on memory usage.
I am trying to print a document in Landscape mode, but it prints rotated and cropped.	Most Unix applications that offer a Landscape orientation option in their printing options will generate correct PostScript code that should be printed as is. In that case, you need to make sure that you leave the LLPR option to its default Portrait setting, to avoid unwanted rotations of the page that would result in a cropped output.
Some pages come out all white (nothing is printed), and I am using CUPS.	If the data being sent is in Encapsulated PostScript (EPS) format, some earlier versions of CUPS (1.1.10 and before) have a bug preventing them from being processed correctly. When going through LLPR to print, the Printer Package will work around this issue by converting the data to regular PostScript. However, if your application bypasses LLPR and feeds EPS data to CUPS, the document may not print correctly.
I can't print to a SMB (Windows) printer.	To be able to configure and use SMB-shared printers (such as printers shared on a Windows machine), you need to have a correct installation of the SAMBA package that enables that feature. The "smbclient" command should be available and usable on your system.
My application seems to be frozen while LLPR is running.	Most Unix applications will expect a command like the regular "lpr" command to be non-interactive and thus return immediately. Since LLPR is waiting for user input before passing the job on to the print spooler, very often the application will wait for the process to return, and thus will appear to be frozen (its windows won't refresh). This is normal and the application should resume functioning correctly after the user exits LLPR.

Problem	Possible Cause and Solution
How do I specify the IP address of my SMB server?	It can be specified in the "Add Printer" dialog of the configuration tool, if you don't use the CUPS printing system. Unfortunately, CUPS currently doesn't allow to specify the IP address of SMB printers, so you will have to be able to browse the resource with Samba in order to be able to print.
Some documents come out as white pages when printing.	Some versions of CUPS, especially those shipped with Mandrake Linux before the 8.1 release, have some known bugs when processing the PostScript output from some applications. Try upgrading to the latest version of CUPS (at least 1.1.14). Some RPM packages for most popular distributions are provided as a convenience with this Linux Printing Package.
I have CUPS and some options (such as N-up) seem to be always enabled even though I don't pick them in LLPR.	There may be some local options defined in your <code>~/lptions</code> file, which is manipulated by the <code>lptions</code> command. These options will always be used if not overridden by LLPR settings. To get rid of all options for a printer, run the following command, replacing "printer" with the name of the queue: <code>lptions -x printer</code>
I configured a printer to print to a file, but I get "Permission denied" errors.	Most printing systems will not run as the super-user but as a special user (usually "lp"). Therefore, make sure that the file you have chosen to print to is accessible to the user owning the spooler daemon.
On my PCL (or SPL) printer, I sometimes get error messages printing instead of my document.	Unfortunately, some Unix applications may generate non-compliant PostScript output that may not be supported by Ghostscript, or even the printer itself in PostScript mode. You can try to capture the output to a file and view the results with Ghostscript (<code>gv</code> or <code>ghostview</code> will allow you to do so interactively) and see if you get error messages. However, since the application is at probably fault, contact your software vendor to inform them of the issue.

Common DOS problem

Problem	Possible Cause and Solution
When using the printer in EPSON Dot Printer Environment, sometimes I can not get the output I want.	Change the emulation to EPSON in the Config tab in the Remote Control Panel. For detailed information about selecting printer settings in the Remote Control Panel, see page 7.14.



7

Appendix

This chapter includes:

- **Using Your Printer in Linux**
- **Printing from DOS Applications**
- **Printer Specifications**
- **Paper Specifications**

Using Your Printer in Linux

Installing the Printer Driver

System Requirements

Supported OS

- Redhat 6.2/7.0/7.1 and above
- Linux Mandrake 7.1/8.0 and above
- SuSE 6.4/7.0/7.1 and above
- Debian 2.2 and above
- Caldera OpenLinux 2.3/2.4 and above
- Turbo Linux 6.0 and above
- Slackware 7.0/7.1 and above

Recommended Requirements

- Pentium IV 1 GHz or higher
- RAM 256 MB or higher
- HDD 1 GB or higher

Softwares

- Glibc 2.1 or higher
- GTK+ 1.2 or higher
- GhostScript

Installing Printer Driver

- 1 Make sure that you connect the printer to your computer. Turn both the computer and the printer on.
- 2 When the Administrator Login window appears, type in **"root"** in the Login field and enter the system password.



Note: You must log in as a super user (root) to install the printer software. If you are not, ask your system administrator.

- 3 Insert the printer software CD-ROM. The CD-ROM automatically runs.



Note: If the CD-ROM does not automatically run, click the  icon at the bottom of the window. When the Terminal screen appears, type in:
[root@local /root]# **cd /mnt/cdrom** (the CD-ROM directory)
[root@local cdrom]# **./setup.sh**

- 4 Select the installation type, either **Recommended** or **Expert**, and then click **Continue**.



Recommended is fully automated and is not required any interaction. **Expert** installation allows you to select the install path or printing system.

- 5 If you selected **Recommended**, go to Step 6.

For **Expert**, select the desired option and then click **Begin Install**.

7



- The printer driver installation begins. When the installation is completed, click **Start**.

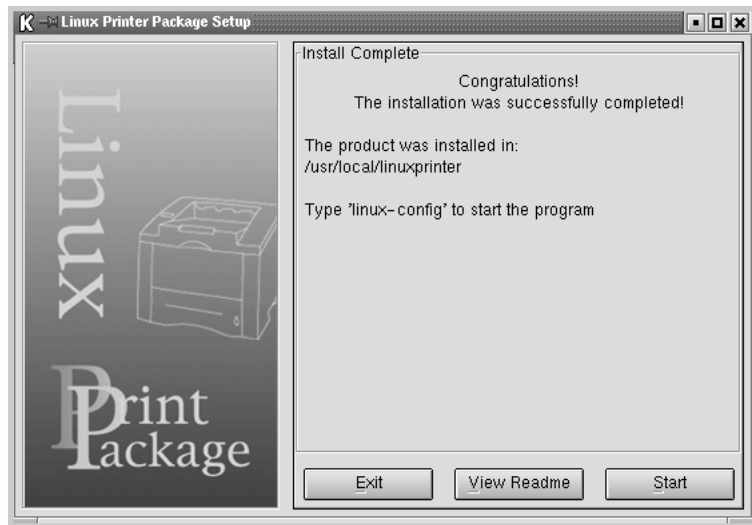

- The Linux Printer Configuration window opens. Click the **Add Printer** icon on the toolbar at the top of the window.



Note: Depending on the printing system in use, the Administrator Login window may appear. Type in **"root"** in the Login field and enter the system password.

- You see the printers currently added in your system. Select the printer you will use. The function tabs available for the selected printer appear at the top of the Add a Printer window.

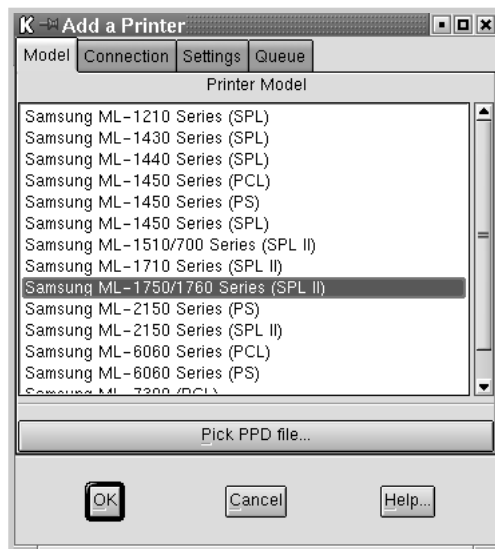

- 9 Click the **Connection** tab and ensure that the printer port is set properly. If not proper, change the device setting.



- 10 You can use the **Settings** tab and the **Queue** tab to view the printer's current setting. If necessary, you can change the settings.



Note: The options may differ depending on the printer in use. The Description and the Location field in the Queue screen may not appear depending on the printing system in use.

- 11 To exit, click **OK**.

- 12 When the window prompts that the new printer is successfully configured, click **OK**.

- 13 The Linux Printer Configuration window re-appears. From the **Info** tab, you can view the information about your printer. If necessary, you can change the printer configuration. For details about changing the printer configuration, see "Using the Configuration Tool" on page 7.8.

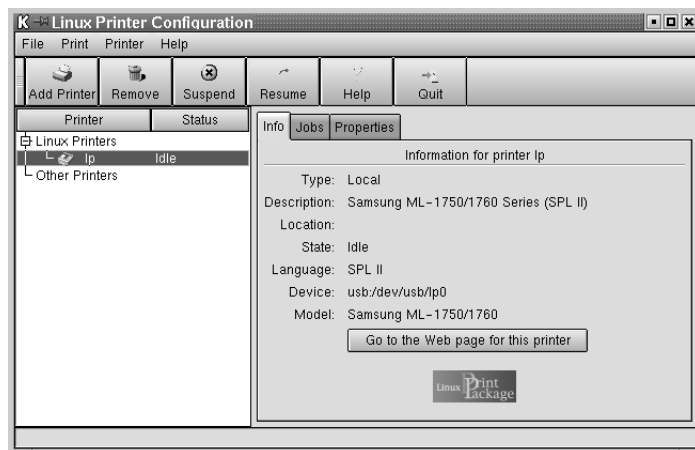

Changing the Printer Connection Method

If you change the printer connection method from USB to parallel or vice versa while in use, you must re-configure your Samsung printer by adding the printer in your system. Take the following steps:

- 1 Make sure that you connect the printer to your computer. Turn both the computer and the printer on.
- 2 When the Administrator Login window appears, type in "**root**" in the Login field and enter the system password.



Note: You must log in as a super user (root) to install a new printer to the printing system. If you are not, ask your system administrator.

- 3 From the Startup Menu icon at the bottom of the desktop, select **Linux Printer** and then **Configuration Tool**.

You can also access the **Linux Printer Configuration** window by typing in "**linux-config**" from the Terminal screen.

- 4 When the **Linux Printer Configuration** window appears, click the **Add Printer** icon on the toolbar at the top of the window.

- 5 Click the **Connection** tab at the top of the **Add a Printer** window.

Ensure that the printer port is set properly. If not proper, change the device setting.



- 6 Click **OK**.

Uninstalling the Printer Driver

- 1 From the Startup Menu icon at the bottom of the desktop, select **Linux Printer** and then **Configuration Tool**.

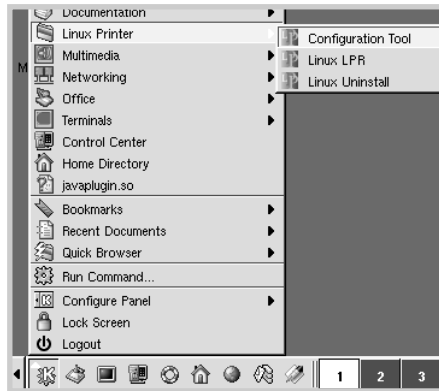

You can also access the Linux Printer Configuration window by typing in "**linux-config**" from the Terminal screen.

- 2 In the **Linux Printer Configuration** window, select the **Uninstall** command from the **File** menu.
- 3 The **Administrator Login** window appears. Type in "**root**" in the Login field and enter the system password. Click **Proceed**.



Note: You must log in as a super user (root) to uninstall the printer software. If you are not, ask your system administrator.

7

- 4 The message window which is asking your confirmation to proceed with the uninstallation appears. Click **Yes**.
- 5 Select **Complete uninstall** and then click **Uninstall**.

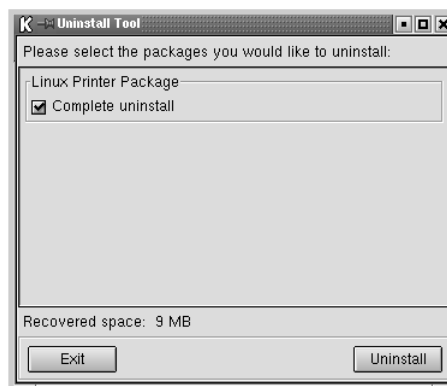

- 6 Click **OK** to begin uninstallation.
- 7 When the uninstallation is completed, click **Finished**.

Using the Configuration Tool

The configuration tool allows the administrative tasks, including adding and removing new printer, and changing their global settings. Regular users can also run it to easily inspect job queues, examine the printer properties and changing their local preference.

To access the Configuration Tool:

- 1 From the Startup Menu icon at the bottom of the screen, select **Linux Printer** and then **Configuration Tool**. The Linux Printer Configuration window appears.

You can also open this window from the Terminal screen by typing in "**linux-config.**"

- 2 The Linux Printer Configuration window shows a list of installed printers at the left pane. The right pane shows a number of tabs that display information regarding the currently selected printer.

Select your printer, if not currently selected.

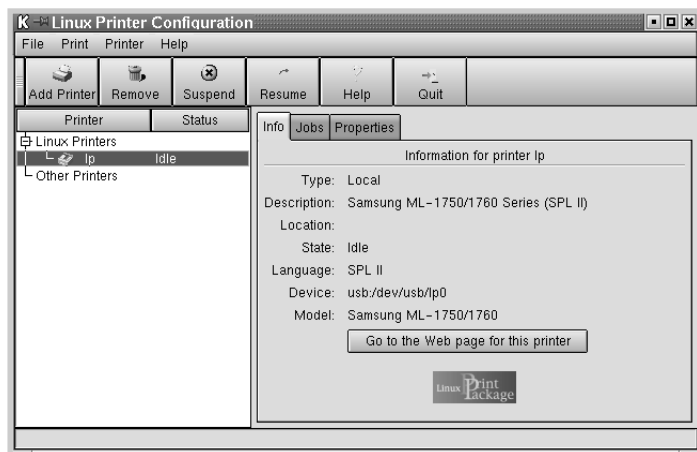

3 The **Info** tab shows general information about the printer.

If you are an Internet user, you can click **Go to the Web page for this printer** to access the Samsung web page.

Click the **Job** tab to inspect and manage the job queue for the selected printer. You can suspend, resume or delete a specific job(s) in the queue. If you drag a specific job(s), you can drop it into the print queue of another printer.

The **Properties** tab allows you to change the default printer settings.



Note: Regular users are able to override the system-wide default settings defined by the administrator. When a regular user clicks **Apply**, these custom settings will be saved in the user's profile and may be later used with LLPR. If the administrator is running the configuration tool, then the settings will be saved as the new global defaults.

Changing LLPR Properties

You can fine tune the printer's properties by opening the LLPR Properties window.

To open the **LLPR Properties** window:

- 1 From the application you are using, select the **Print** command.
- 2 When the Linux LPR window opens, click **Properties**.

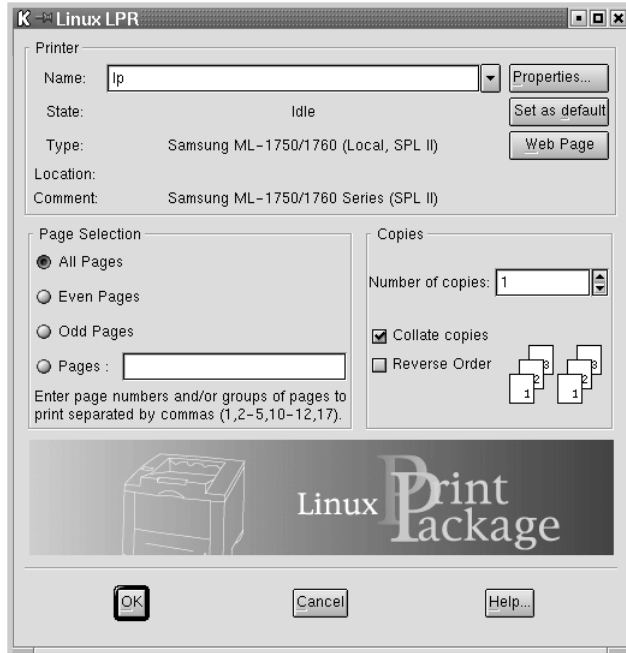

You can also open the LLPR window by using the following:

- Click the Startup Menu icon at the bottom of the screen and select **Linux Printer** and then **Linux LPR**.
- If the Linux Printer Configuration window is currently open, select **Test Print** from the **Print** menu.

3 The LLPR Properties window opens.

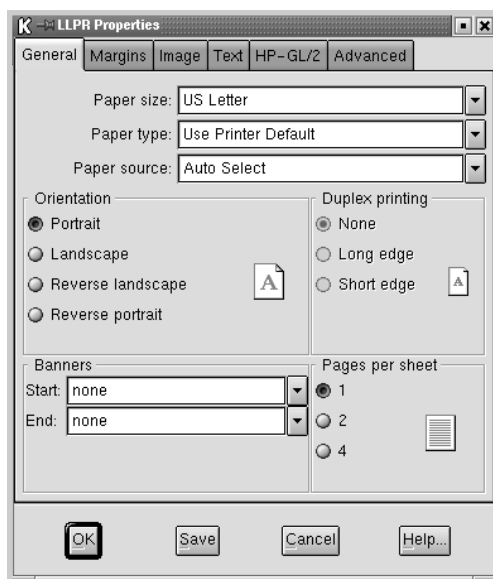

You will see the following six tabs at the top of the window:

- **General** - allows you to change the paper size, the paper type, the paper source, the orientation of the documents, enable duplex feature, add start and end banners, and change the number of pages per sheet.
- **Margins** - allows you to specify the page margins. The graphics on the right shows the current settings. These margins do not apply when printing regular PostScript data.
- **Image** - allows you to set image options that will be used when printing images files, i.e. when a non-PostScript document is passed to LLPR on the command line. But color settings will also take effect for postscript documents.
- **Text** - allows you to select the density of the text and turn the syntax coloring on or off.
- **HP-GL/2** - allows you to set default options to print documents of the HP-GL/2 format, which is used by some plotters.
- **Advanced** - allows you to override the default settings for the printer.

If you click the **Save** button at the bottom of the window, the options will be kept between LLPR session.

Use the **Help** button to view details about the options in the window.

- 4 To apply the options, click **OK** in the **LLPR Properties** window. You will return to the **Linux LPR** window. To start printing, click **OK**.

Printing from DOS Applications

While your printer is primarily a Windows printer, you can also print from a DOS software program using the Remote Control Panel utility provided in the supplied software CD-ROM.

About the Remote Control Panel

DOS users have access to many printer features through specific DOS printer drivers; however, many software manufacturers do not develop printer drivers for their software programs. The printer provides the software control panel for improved printer control when DOS printer drivers are not available or when certain print settings are not available through DOS software programs.



Note: The printer's Remote Control Panel is not a printer driver. It should be used to set print settings that are not available through DOS software programs. Printer drivers are supplied by the manufacturers of your DOS software programs. If your DOS software program does not include a printer driver for your printer, contact the manufacturer of the software program or use one of the alternate printer drivers.

Installing the Remote Control Panel

The Remote Control Panel utility is provided on the printer software CD-ROM.

- 1 Place the CD-ROM in the CD-ROM drive. Installation will start automatically.

If the CD-ROM drive does not automatically run:

Select **Run** from the **Start** menu, and type **x:\cdsetup.exe** in the Open box (where **x** is the drive letter for the CD-ROM drive), and click **OK**.

- 2 When the language selection window appears, select the appropriate language.

If you can't find the desired language from the screen, scroll through the window using the scroll button on the bottom right of the window.

- 3 Click **Install the Samsung Software-III on your PC (WinRCP)**.

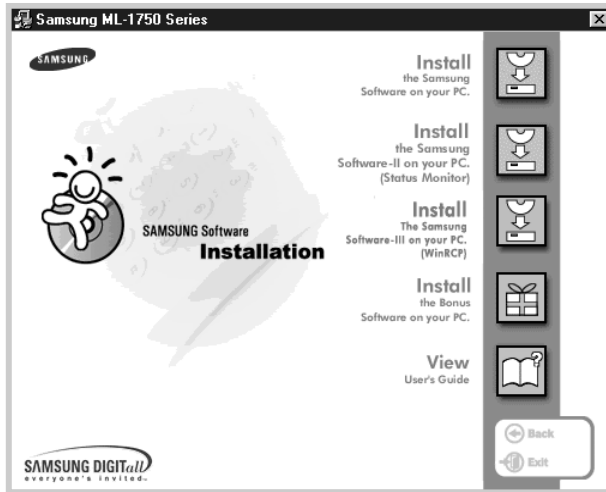

- 4 Click **Next**.

The files are copied into the appropriate directory.

- 5 After the installation is completed, click **Finish**.

Uninstalling the Remote Control Panel

The Uninstall icon in the Samsung ML-1750 series program group allows you to select and remove any or all of the Windows ML-1750 printing system components.

- 1 From the **Start** menu, select **Programs**.
- 2 Select **Samsung ML-1750 Series**, and then **Uninstall Remote Control Panel**.
- 3 Click **OK**.

The Samsung ML-1750 Series Remote Control Panel and all of its components are removed from your computer.

- 4 Click **Finish**.

Selecting Print Settings

You can use this Remote Control Panel to select print settings that may not be available on some DOS programs. Typically, duplicate print settings that are selected from a DOS software program override the ones that are selected in the Remote Control Panel.

Starting Remote Control Panel

- 1 From the **Start** menu, select **Programs**.
- 2 Select **Samsung ML-1750 Series**, and then **Remote Control Panel**.
- 3 The Remote Control Panel window allows you to access all the information you need when using your printer. If necessary, click other tabs on the top of the window to access other features.

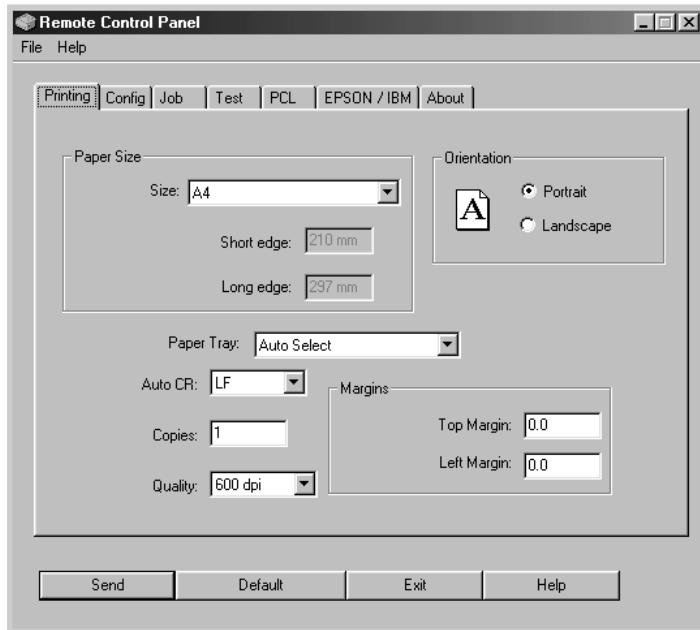

- 4 When you finish changing the settings, click **Send** until the Print window is displayed.

The Remote Control Panel allows you to access the following features:

PRINTING

In this tab, you can configure general settings for printing.

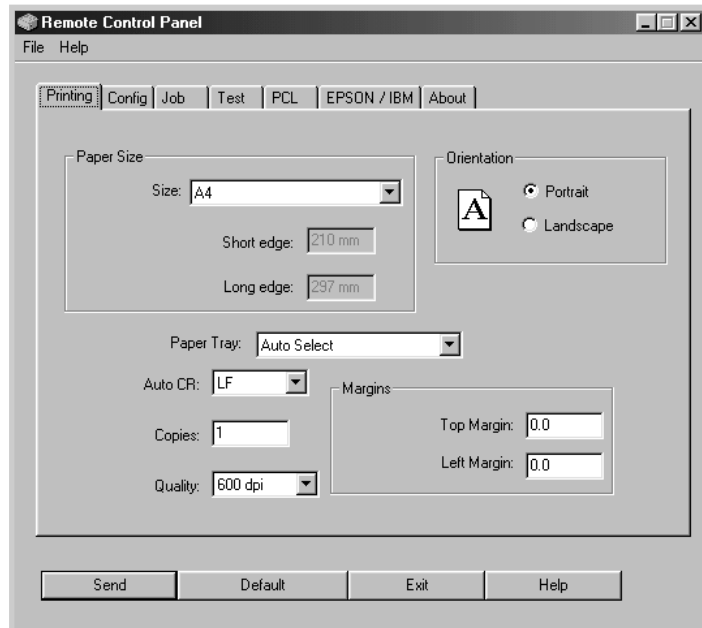

- **Paper Size** sets the paper size.
- **Orientation** determines how the output is printed on the page.
- **Paper Tray** sets the default paper source.
- **Auto CR** sets how the printer performs a carriage return.
- **Copies** sets the number of copies printed for each page.
- **Quality** specifies the print quality.
- **Margins** sets the top and left margin of the print material.

CONFIG

You can configure various printer features.

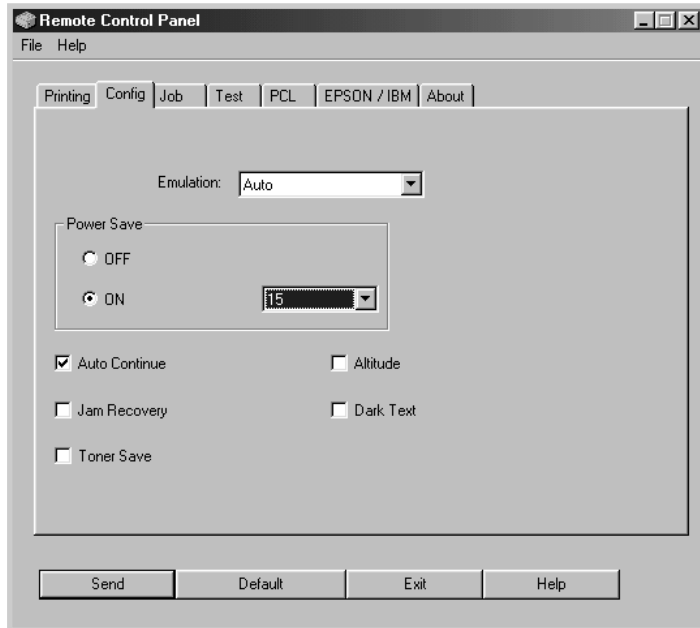

- **Emulation** selects the emulation for printing a document. The factory default is **Auto**.
- **Power Save** determines the length of time the printer waits after a job is printed before it goes to a reduced power state. If the printer is used frequently, select **OFF** which keeps the printer ready to print with the minimum warm-up time. This uses more power to keep the printer warm and ready to print.
- **Auto Continue** determines what action the printer should take when a manual feed print job is sent to the printer. If it is checked, the printer will pick up the paper from the tray after fifteen seconds. Otherwise, the printer will wait for you to load paper in the manual feeder.
- **Jam Recovery** determines what action the printer should take when a paper jam occurs. If it is unchecked, the printer does not reprint a page that has jammed. If it is checked, the printer keeps the image in memory for a printed page until the printer signals that the page has successfully printed. The printer reprints all jammed pages.
- **Toner Save** determines the toner quantity the printer should use when printing. If it is checked, the printer conserves toner when printing. The default value is unchecked, which provides 100% usage.
- **Altitude**: helps the printer optimize its output for a low pressure area, such as a high mountain area.

- **Dark Text:** allows all text in your document to be printed darker than a normal document.

JOB

You can set options for improving the quality of your print job.

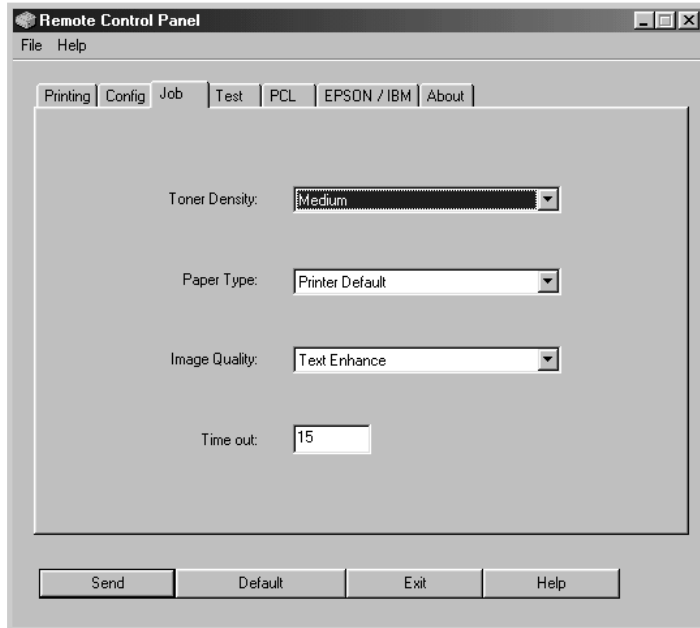

- **Toner Density** determines the toner density of page. The default value is **Medium**.
- **Paper Type** provides the printer with information about the type of paper to be used for a print job. For the best result, set this to the paper type you loaded in the tray of the printer. When using the plain paper, set this to **Printer default**.
- **Image Quality** improves the print quality of your text and image and make the characters and images appear smoother. It is preset to **Text Enhancement** at the factory.
- **Time out** determines the amount of time (in seconds) the printer will wait before printing the last pag of a print job that does not end with a command to print the page or a formfeed character. You can set from 0 to 300 seconds.

TEST

This tab allows you to print a resident page to test your printer's performance.

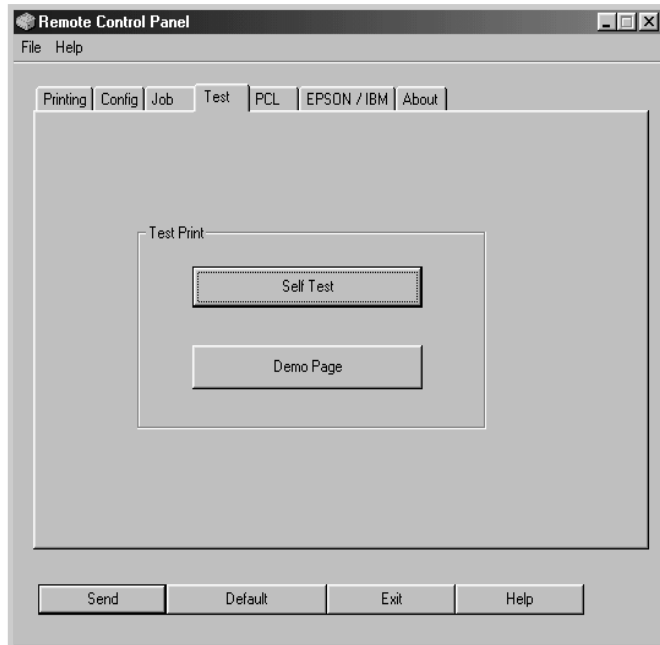

- **Self Test** prints a configuration sheet. A list of the user default settings and the amount of printer memory available prints.
- **Demo Page** prints a demonstration page. It shows the printer features and specifications.

PCL

In this tab, you can configure various settings for PCL emulation.

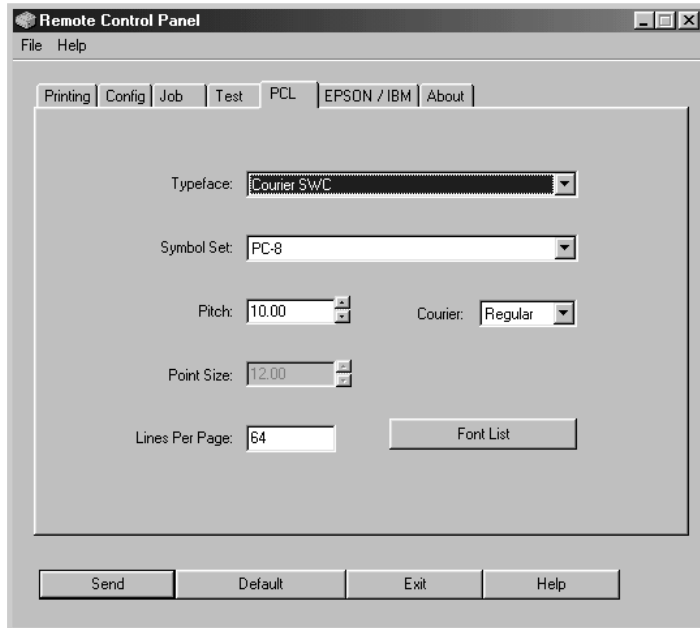

- **Typeface** allows you to select the desired typeface. This setting is ignored when the software application specifies a font.
- **Symbol Set** determines the symbol set. A symbol set is a set of alphabetic and numeric characters, punctuation, and special symbols used when printing with a selected font.
- **Pitch** sets the font pitch (only if you have selected a scalable monospaced font). Pitch refers to the number of fixed-space characters in a horizontal inch of type.
- **Point Size** sets the font point size (only if you have selected a scalable typographic font). Point size refers to the height of the characters in the font. One point equals approximately 1/72 of an inch. You can select point sizes from 4.0 to 999.75 in increments of 0.25 points.
- **Lines Per Page** sets the number of lines that print on each page. The setting can range from 5 to 128 lines per page.
- **Courier** determines the courier font type: **Regular** or **Dark**.
- **Font List** prints a font list showing all the fonts available for PCL emulation.

EPSON/IBM

You can configure various settings for EPSON emulation.

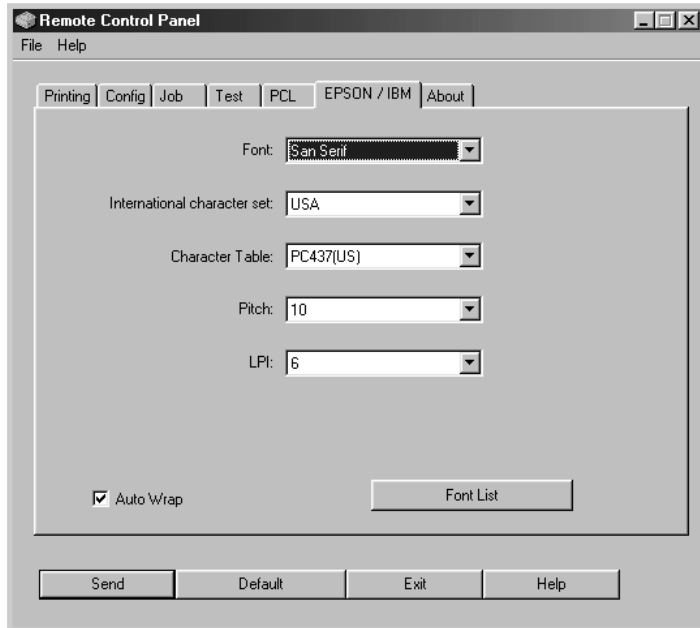

- **Font** allows you to select the desired font.
- **International character set** allows you to select a character set of the desired language.
- **Character Table** selects the character sets.
- **Pitch** sets the font pitch. Pitch refers to the number of fixed-space characters in a horizontal inch of type.
- **LPI** sets the number of lines printed a vertical inch. You can select 6 or 8 lines.
- **Auto Wrap** determines whether or not the printer automatically performs line feed when the data overflows the printable area of the print material.
- **Font List** prints a font list showing all the fonts available for EPSON emulation.

Printer Specifications

Item	Specifications and Description
Print Speed*	Up to 16 PPM in A4 (17 PPM in Letter)
Resolution	1200 x 600 dpi
First Printing Time	12 seconds
Warmup Time	30 seconds
Power Rating	AC 110 ~ 127 V (USA, Canada) / 220 ~ 240 V (Others), 50 / 60 Hz
Power Consumption	330 W average during operation / Less than 10 W in sleep mode
Acoustic Noise**	Stand by: Less than 35 dB; Printing: Less than 52 dB Sleep mode: Background noise
Toner Supply	Single cartridge
Toner Cartridge Life***	3,000 A4/Letter pages at 5% Coverage (Ships with 1,000 pages Starter toner cartridge)
Duty Cycle	Monthly: Up to 15,000 pages maximum
Weight	7 Kg
Package Weight	Paper: 1.76 Kg, Plastic: 0.2 Kg
External Dimensions (W x D x H)	352 x 372 x 196 mm / 13.8 x 14.6 x 7.7 in.
Operating Environment	Temperature: 10 ~ 32 °C / 50 ~ 90 °F; Humidity: 20 ~ 80 % RH
Emulation	PCL 6, IBM ProPrinter, EPSON
Random Access Memory (RAM)	<ul style="list-style-type: none"> • ML-1750: 8 MB (nonexpandable) • ML-1755: 32 MB (nonexpandable)
Fonts	1 bitmap, 45 scalable
Interface Switching	Automatic (Parallel, USB)
Interface	<ul style="list-style-type: none"> • IEEE 1284 Parallel • USB 1.1 (Compatible with USB 2.0)

* Print speed will be affected by Operating system used, computing performance, application software, connecting method, media type, media size and job complexity.

** Sound Pressure Level, ISO7779

*** May be affected by operating environment, printing interval, media type, media size.

Paper Specifications

Overview

Your printer accepts a variety of print materials, such as cut-sheet paper (including up to 100% recycled fiber content paper), envelopes, labels, transparencies and custom-size paper. Properties, such as weight, composition, grain and moisture content, are important factors affecting the printer's performance and the output quality. Paper that does not meet the guidelines outlined in this User's Guide can cause the following problems:

- Poor print quality
- Increased paper jams
- Premature wear on the printer.



Notes:

- Some paper may meet all of the guidelines in this guide and still not produce satisfactory results. This may be the result of improper handling, unacceptable temperature and humidity levels, or other variables over which Samsung has no control.
 - Before purchasing large quantities of paper, ensure the paper meets the requirements specified in this User's Guide.
-



CAUTION: Using paper that does not meet these specifications may cause problems, requiring repairs. These repairs are not covered by the Samsung warranty or service agreements.

Supported Sizes of Paper

Paper	Dimensions ^a	Weight	Capacity ^b
Letter	8.5 X 11 in. (216 X 279 mm)	60 to 90 g/m ² bond (16 to 24 lb)	<ul style="list-style-type: none"> • 250 sheets of 75 g/m² bond (20 lb) paper for the tray • 1 sheet of paper for the manual feeder
A4	210 X 297 mm (8.3 X 11.7 in.)		
Executive	7.25 X 10.5 in. (191 X 267 mm)		
Legal	8.5 X 14 in. (216 X 356 mm)		
B5 (JIS)	182 X 257 mm (7.2 X 10 in.)		
Folio	216 X 330 mm (8.5 X 13 in.)		
Minimum size (custom)	76 x 127 mm (3 x 5 in)	60 to 163 g/m ² bond (16 to 43 lb)	1 sheet of paper for the manual feeder
Maximum size (custom)	216 x 356mm (8.5 x 14 in)		
Transparency	Same minimum and maximum paper sizes as listed above.	Thickness: 0.10 X .14 mm (0.0039 X 0.0055 in.)	
Labels		up to 90 g/m ² bond (16 to 24 lb)	
Envelopes			

a. The printer supports a wide range of media sizes. See "Printing on Card Stock or Custom-sized Materials" on page 3.15.

b. Capacity may vary depending on media weight and thickness, and environmental conditions.



Note: You may experience jams when using print materials with a length of less than 127 mm (5 in.). For optimum performance, ensure that you are storing and handling the paper correctly. Please refer to "Printer and Paper Storage Environment" on page 7.26.

Guidelines for Using Paper

For the best result, use conventional 75 g/m² (20 lb) paper. Ensure that the paper is of good quality, and free of cuts, nicks, tears, spots, loose particles, dust, wrinkles, voids, and curled or bent edges.

If you are unsure of what type of paper you are loading (such as, bond or recycled), check the label on the package.

The following problems may cause print quality deviations, jamming or even damage to the printer.

Symptom	Problem with Paper	Solution
Poor print quality or toner adhesion, problems with feeding	Too moist, too rough, too smooth or embossed; faulty paper lot	Try another kind of paper, between 100 ~ 250 Sheffield, 4 ~ 5 % moisture content.
Dropout, jamming, curl	Stored improperly	Store paper flat in its moisture-proof wrapping.
Increased gray background shading/printer wear	Too heavy	Use lighter paper, open the rear output tray.
Excessive curl problems with feeding	Too moist, wrong grain direction or short-grain construction	<ul style="list-style-type: none">• Open the rear output tray.• Use long-grain paper.
Jamming, damage to printer	Cutouts or perforations	Do not use paper with cutouts or perforations.
Problems with feeding	Ragged edges	Use good quality paper.



Notes:

- Do not use letterhead paper printed with low-temperature inks, such as those used in some types of thermography.
- Do not use raised or embossed letterhead.
- The printer uses heat and pressure to fuse toner to the paper. Ensure that any colored paper or preprinted forms use inks that are compatible with this fusing temperature (200 °C or 392 °F for 0.1 second).

Paper Specifications

Category	Specifications
Acid Content	5.5 ~ 8.0 pH
Caliper	0.094 ~ 0.18 mm (3.0 ~ 7.0 mils)
Curl in Ream	Flat within 5 mm (0.02 in.)
Cut Edge Conditions	Cut with sharp blades with no visible fray.
Fusing Compatibility	Must not scorch, melt, offset, or release hazardous emissions when heated to 200 °C (392 °F) for 0.1 second.
Grain	Long Grain
Moisture Content	4 % ~ 6 % by weight
Smoothness	100 ~ 250 Sheffield

Paper Output Capacity

Output Tray	Capacity
Face-down output tray	50 sheets of 75 g/m ² bond (20 lb) paper
Face-up output slot	1 sheet of 75 g/m ² bond (20 lb) paper

Printer and Paper Storage Environment

Paper storage environmental conditions directly affect the feed operation.

Ideally, the printer and paper storage environment should be at or near room temperature, and not too dry or humid. Remember that paper is hygroscopic; it absorbs and loses moisture rapidly.

Heat works with humidity to damage paper. Heat causes the moisture in paper to evaporate, while cold causes it to condense on the sheets. Heating systems and air conditioners remove most of the humidity from a room. As paper is opened and used, it loses moisture, causing streaks and smudging. Humid weather or water coolers can cause the humidity to increase in a room. As paper is opened and used it absorbs any excess moisture, causing light print and dropouts. Also, as paper loses and gains moisture it can become distorted. This can cause paper jams.

Care should be taken not to purchase more paper than can be used in a short time (about 3 months). Paper stored for long periods may experience heat and moisture extremes, which can cause damage. Planning is important to prevent damage to large supplies of paper.

Unopened paper in sealed reams can remain stable for several months before use. Opened packages of paper have more potential for environment damage, especially if they are not wrapped with a moisture-proof barrier.

The paper storage environment should be properly maintained to ensure optimum printer performance. The required condition is 20° to 24°C (68° to 75°F), with a relative humidity of 45% to 55%. The following guidelines should be considered when evaluating the paper's storage environment:

- Paper should be stored at or near room temperature.
- The air should not be too dry or too humid.
- The best way to store an opened ream of paper is to rewrap it tightly in its moisture-proof wrapping. If the printer environment is subject to extremes, unwrap only the amount of paper to be used during the day's operation to prevent unwanted moisture changes.



INDEX

C

- cancel, print 4.4
- clean, printer 5.5
- cleaning sheet, print 5.7
- connect
 - parallel cable 2.9
 - power cord 2.11
 - USB cable 2.10
- control panel,use 1.6

D

- demo page, print 2.12
- document, print 4.2

E

- error, solve 6.18

I

- install
 - software 2.15
 - toner 2.4
 - USB driver 2.18

L

- language, change 2.17
- load paper 3.7

O

- output tray, select 3.5
- overlay
 - create 4.22
 - delete 4.25
 - print 4.24

P

- paper jams, clear 6.7
- paper load
 - in manual feeder 3.8
 - in tray 2.6, 3.7
- paper size 3.3
- paper, capacity 3.3
- paper, guidelines 3.4
- print
 - cleaning sheet 5.7
 - demo page 2.12
 - document 4.2
 - fit to page 4.13
 - N-up 4.10
 - overlay 4.22
 - poster 4.14
 - scale 4.12
 - watermark 4.19
- printer cable, connect 2.9
- printer, clean 5.5
- printer, sharing 4.28
- problem
 - DOS 6.23
 - Linux 6.20
 - windows 6.19

S

- setting
 - darkness 4.16
 - favorite 4.5
 - image mode 4.16
 - paper size 4.6
 - paper source 4.6
 - paper type 4.6
 - resolution 4.16
 - toner save 4.16
 - true-type option 4.16
- software

- DOS 7.12
- install 2.15
- Linux 7.2
- overview 2.13
- reinstall 2.16
- system requirements 2.15
- uninstall 2.17
- specification
 - paper 7.22
 - printer 7.21
- status monitor, use 4.26

T

- toner
 - install 2.4
 - life 5.2
 - redistribute 5.3
 - replace 5.4
- toner save 4.8

W

- watermark
 - create 4.20
 - delete 4.21
 - edit 4.21
 - print 4.19



Home

Visit us at:

www.samsungprinter.com

Rev.5.00