

SAMSUNG



SAMSUNG LASER MFP User's Guide

SCX-4720FN

For UK customers:

To reorder your consumables

Call 0800 3164060

For Technical Assistance

Call 0870 2420303

About the User's Guide

This Laser MFP User's Guide provides information you need for setting up your machine and installing the supplied software. It also provides all of the detailed instructions for using your machine as a printer, a scanner, a copier, and a facsimile, and information for maintaining and troubleshooting the machine. The User's Guide shows you how to use a USB flash drive with your machine for scanning and saving documents, and printing documents stored on the USB flash drive.

This guide also provides the basic description of the multi-function application, Samsung SmarThru. SmarThru allows you to scan and edit images and to scan for copying. SmarThru also lets you access scanned images that you can then email from your computer.

This manual is provided for information purposes only. All information included herein is subject to change without notice. Samsung Electronics is not responsible for any changes, direct or indirect, arising from or related to use of this manual.

© 2005 Samsung Electronics Co., Ltd. All rights reserved.

- SCX-4720FN is model names of Samsung Electronics Co., Ltd.
- SAMSUNG and Samsung logo are trademarks of Samsung Electronics Co., Ltd.
- Centronics is a trademark of Centronics Data Computer Corporation.
- IBM and IBM PC are trademarks of International Business Machines Corporation.
- PCL and PCL 6 are trademarks of Hewlett-Packard company.
- Microsoft, Windows, Windows 98, Windows Me, Windows 2000, Windows NT 4.0, and Windows XP are registered trademarks of Microsoft Corporation.
- All other brand or product names are trademarks of their respective companies or organizations.

Contact SAMSUNG WORLD WIDE

If you have any comments or questions regarding Samsung products, contact the SAMSUNG customer care center.

Country	Customer Care Center	Web Site
CANADA	1-800-SAMSUNG (7267864)	www.samsung.com/ca
MEXICO	01-800-SAMSUNG (7267864)	www.samsung.com/mx
U.S.A	1-800-SAMSUNG (7267864)	www.samsung.com
ARGENTINE	0800-333-3733	www.samsung.com/ar
BRAZIL	0800-124-421	www.samsung.com/br
CHILE	800-726-7864 (SAMSUNG)	www.samsung.com/cl
COSTA RICA	0-800-507-7267	www.samsung.com/latin
ECUADOR	1-800-10-7267	www.samsung.com/latin
EL SALVADOR	800-6225	www.samsung.com/latin
GUATEMALA	1-800-299-0013	www.samsung.com/latin
JAMAICA	1-800-234-7267	www.samsung.com/latin
PANAMA	800-7267	www.samsung.com/latin
PUERTO RICO	1-800-682-3180	www.samsung.com/latin
REP. DOMINICA	1-800-751-2676	www.samsung.com/latin
TRINIDAD & TOBAGO	1-800-7267-864	www.samsung.com/latin
VENEZUELA	1-800-100-5303	www.samsung.com/latin
BELGIUM	02 201 2418	www.samsung.com/be
CZECH REPUBLIC	844 000 844	www.samsung.com/cz
DENMARK	38 322 887	www.samsung.com/dk
FINLAND	09 693 79 554	www.samsung.com/fi
FRANCE	08 25 08 65 65 (€ 0,15/min)	www.samsung.com/fr
GERMANY	01805 - 121213 (€ 0,12/min)	www.samsung.de

Country	Customer Care Center	Web Site
HUNGARY	06 40 985 985	www.samsung.com/hu
ITALIA	199 153 153	www.samsung.com/it
LUXEMBURG	02 261 03 710	www.samsung.lu
NETHERLANDS	0900 20 200 88 (€ 0,10/min)	www.samsung.com/nl
NORWAY	231 627 22	www.samsung.com/no
POLAND	0 801 801 881	www.samsung.com/pl
PORTUGAL	80 8 200 128	www.samsung.com/pt
SLOVAKIA	0850 123 989	www.samsung.com/sk
SPAIN	902 10 11 30	www.samsung.com/es
SWEDEN	08 585 367 87	www.samsung.com/se
U.K	0870 242 0303	www.samsung.com/uk
RUSSIA	8-800-200-0400	www.samsung.ru
UKRAINE	8-800-502-0000	www.samsung.com/ur
AUSTRALIA	1300 362 603	www.samsung.com/au
CHINA	800-810-5858 010- 6475 1880	www.samsung.com.cn
HONG KONG	2862 6001	www.samsung.com/hk
INDIA	3030 8282 1600 1100 11	www.samsung.com/in
INDONESIA	0800-112-8888	www.samsung.com/id
JAPAN	0120-327-527	www.samsung.com/jp
MALAYSIA	1800-88-9999	www.samsung.com/my
PHILIPPINES	1800-10-SAMSUNG (7267864)	www.samsung.com/ph
SINGAPORE	1800-SAMSUNG (7267864)	www.samsung.com/sg
THAILAND	1800-29-3232 02-689-3232	www.samsung.com/th
TAIWAN	0800-329-999	www.samsung.com/tw
VIETNAM	1 800 588 889	www.samsung.com/vn
SOUTH AFRICA	0860 7267864 (SAMSUNG)	www.samsung.com/za
U.A.E	800SAMSUNG (7267864)	www.samsung.com/mea

CONTENTS

1. INTRODUCTION

Special Features	1.2
Understanding Component Locations	1.4
Front View	1.4
Rear View	1.5
Control Panel Functions	1.6

2. GETTING STARTED

Unpacking	2.2
Selecting a Location	2.4
Installing the Toner Cartridge	2.5
Loading Paper	2.7
Making Connections	2.11
Turning the Machine On	2.14
Changing the Display Language	2.15
Setting the Machine ID	2.16
Entering Characters Using the Number Keypad	2.17
Setting the Date and Time	2.19
Changing the Clock Mode	2.20
Setting the Paper Size and Type	2.20
Setting Sounds	2.21
Speaker, Ringer, Key Sound, and Alarm Sound	2.21
Speaker Volume	2.22
Using the Save Modes	2.23
Toner Save Mode	2.23
Toll Save Mode	2.23
Power Save Mode	2.24
Scan Lamp Save Mode	2.25
About Samsung Software	2.26
Printer Driver Features	2.27
Installing Samsung Software in Windows	2.28
System Requirements	2.28
Installing Software for Local Printing	2.29
Installing Software for Network Printing	2.34
Repairing Software	2.41
Removing Software	2.43
Uninstalling the MFP Driver	2.43
Uninstalling the SmarThru	2.44
Uninstalling the Network Scan Driver	2.44
Using the Printer Settings Utility	2.45

3. PAPER HANDLING

Selecting Print Materials	3.2
Paper Type, Input Sources, and Capacities	3.2
Guidelines for Paper and Special Materials	3.3
Loading Paper	3.4
In the Standard Tray	3.4
In the Multipurpose Tray	3.6
Using the Manual Feed Mode	3.8
Selecting an Output Location	3.10
Printing to the Front Output Tray (Face down)	3.10
Printing to the Rear Output Slot (Face up)	3.11

4. PRINTING TASKS

Printing a Document in Windows	4.2
Canceling a Print Job	4.3
Printer Settings	4.4
Layout tab	4.5
Paper Tab	4.6
Graphic Tab	4.8
Extras Tab	4.10
About Tab	4.11
Printer Tab	4.11
Using a Favorite Setting	4.12
Using Help	4.12
Printing Multiple Pages on One Sheet of Paper	4.13
Printing Posters	4.14
Fitting Your Document to a Selected Paper Size	4.16
Printing a Reduced or Enlarged Document	4.17
Using Watermarks	4.18
Using an Existing Watermark	4.18
Creating a Watermark	4.19
Editing a Watermark	4.20
Deleting a Watermark	4.20
Using Overlays	4.21
What is an Overlay?	4.21
Creating a New Page Overlay	4.21
Using a Page Overlay	4.22
Deleting a Page Overlay	4.24

5. COPYING

Loading Paper for Copying	5.2
Selecting the Paper Tray	5.2
Preparing a Document	5.3
Making Copies on the Document Glass	5.4
Making Copies from the Automatic Document Feeder	5.5
Setting Copy Options	5.7
Darkness	5.7
Original Type	5.7
Reduced/Enlarged Copy	5.8
Number of Copies	5.9

Using Special Copy Features	5.9
Clone Copying	5.10
Collation Copying	5.10
Auto Fit Copying	5.11
2 Sides on 1 Page Copying	5.11
2 Up or 4 Up Copying	5.12
Poster Copying	5.13
Changing the Default Settings	5.14
Setting the Time Out Option	5.15

6. SCANNING

Scanning Basics	6.2
Scanning From the Control Panel to an Application	6.3
Scanning Using Samsung SmarThru	6.4
Using Onscreen Help File	6.6
Scanning Using the WIA Driver	6.7
Scanning to USB Flash Drive	6.8
Scanning Using the Network Scan	6.9
About Network Scan	6.9
Setting the Network Scan	6.9
Scanning Using Network Scan	6.9
Setting Network Scan Timeout	6.11
Using the Network Scan driver	6.12
Adding a Scanner	6.12
Removing a Scanner	6.14
Setting the properties	6.14
Scanning using the Network Scan driver	6.17
Scanner Icons	6.17

7. FAXING

Changing the Fax Setup options	7.2
Available Fax Setup Options	7.3
Loading a Document	7.6
Selecting the Paper Tray	7.9
Adjusting the Document Resolution	7.9
Sending a Fax Automatically	7.11
Sending a Fax Manually	7.12
Redialing the Last Number	7.12
Confirming Transmission	7.13
Automatic Redialing	7.13
About Receiving Modes	7.14
Loading Paper for Receiving Faxes	7.15
Receiving Automatically in Fax Mode	7.15
Receiving Manually in Tel Mode	7.15
Receiving Automatically in Ans/Fax Mode	7.16
Receiving Manually Using an Extension Telephone	7.16
Receiving Faxes Using the DRPD Mode	7.17
Receiving Faxes in the Memory	7.18
One-touch Dialing	7.19
Storing a Number for One-touch Dialing	7.19
Sending a Fax using a One-touch Number	7.20

Speed Dialing	7.21
Storing a Number for Speed Dialing	7.21
Sending a Fax using a Speed Dial Number	7.22
Group Dialing	7.23
Setting a Group Dial Number	7.23
Editing Group Dial Numbers	7.24
Sending a Fax Using Group Dialing (Multi-address Transmission)	7.25
Searching for a Number in Memory	7.26
Searching Sequentially through the Memory	7.26
Searching with a Particular First Letter	7.26
Printing a Phonebook List	7.27
Sending Broadcast Faxes	7.28
Sending a Delayed Fax	7.29
Sending a Priority Fax	7.31
Adding Documents To a Scheduled Fax	7.32
Canceling a Scheduled Fax	7.33
Using Secure Receiving Mode	7.34
Printing Reports	7.35
Using Advanced Fax Settings	7.37
Changing Setting Options	7.37
Advanced Fax Setting Options	7.38

8. MAINTENANCE

Clearing the Memory	8.2
Cleaning Your Machine	8.3
Cleaning the Outside	8.3
Cleaning the Inside	8.3
Cleaning the Scan Unit	8.5
Maintaining the Toner Cartridge	8.6
Redistributing Toner	8.7
Replacing the Toner Cartridge	8.8
Setting the Notify Toner Option	8.10
Cleaning the Drum	8.10
Ignoring the Toner Empty Message	8.12
Consumables and Replacement Parts	8.13
Replacing the ADF Rubber Pad	8.14
Setting E-mail Notification	8.16
Setting the Machine Setup tab	8.16
Setting the Contact Information tab	8.19

9. TROUBLESHOOTING

Clearing Document Jams	9.2
Input Misfeed	9.2
Exit Misfeed	9.3
Roller Misfeed	9.4
Clearing Paper Jams	9.5
In Tray 1	9.5
In Optional Tray 2	9.6
In the Fuser Area or Around the Toner Cartridge	9.7
In the Paper Exit Area	9.9
In the Multipurpose Tray	9.10
Tips for Avoiding Paper Jams	9.11

Clearing LCD Error Messages	9.12
Solving Other Problems	9.16
Paper Feeding Problems	9.16
Printing Problems	9.17
Printing Quality Problems	9.19
Copying Problems	9.24
Scanning Problems	9.25
Fax Problems	9.26
Network Scan Problems	9.27
Common Linux Problems	9.28

10. USING USB FLASH DRIVE

About USB Flash Drives	10.2
Installing a USB Flash Drive	10.2
Scanning to USB Flash Drive	10.3
Scanning With Default Settings	10.3
Scanning With Your Own Settings	10.4
Managing the USB Flash Drive	10.6
Changing the Default Settings	10.6
Deleting an Image File	10.7
Formatting the USB Flash Drive	10.8
Viewing the USB Memory Status	10.9
Printing From the USB Flash Drive	10.10
Backing Up Data	10.11

A. USING YOUR MACHINE IN LINUX

Getting Started	A.2
Installing the MFP Driver	A.3
System Requirements	A.3
Installing the MFP Driver	A.4
Uninstalling the MFP Driver	A.6
Using the MFP Configurator	A.7
Opening the MFP Configurator	A.7
Printers Configuration	A.8
Scanners Configuration	A.9
MFP Ports Configuration	A.10
Configuring Printer Properties	A.11
Printing a Document	A.12
Printing from Applications	A.12
Printing Files	A.13
Scanning a Document	A.14
Using the Image Editor	A.17

B. USING YOUR MACHINE ON A NETWORK

About Sharing the Machine on a Network	B.2
Setting Up a Locally-Shared Machine	B.3
In Windows 98/Me	B.3
In Windows NT 4.0/2000/XP	B.4
Setting Up a Network-Connected Machine	B.5
Configuring Network Parameters on the Control Panel	B.5

C. INSTALLING MACHINE OPTIONS

Installing Memory DIMM	C.2
Removing a Memory DIMM	C.4
Installing an Optional Tray	C.5
Setting Tray 2 in the Printer Properties	C.7

D. SPECIFICATIONS

General Specifications	D.2
Scanner and Copier Specifications	D.3
Printer Specifications	D.4
Facsimile Specifications	D.5
Paper Specifications	D.6
Overview	D.6
Supported Sizes of Paper	D.7
Guidelines for Using Paper	D.8
Paper Specifications	D.9
Paper Output Capacity	D.9
Paper Storage Environment	D.9

Important Precautions and Safety Information

When using this machine, these basic safety precautions should always be followed to reduce risk of fire, electric shock and injury to people:

1. Read and understand all instructions.
2. Use common sense whenever operating electrical appliances.
3. Follow all warnings and instructions marked on the machine and in the literature accompanying the machine.
4. If an operating instruction appears to conflict with safety information, heed the safety information. You may have misunderstood the operating instruction. If you cannot resolve the conflict, contact your sales or service representative for assistance.
5. Unplug the machine from the AC wall socket and/or telephone jack before cleaning. Do not use liquid or aerosol cleaners. Use only a damp cloth for cleaning.
6. Do not place the machine on an unstable cart, stand or table. It may fall, causing serious damage.
7. Your machine should never be placed on, near or over a radiator, heater, air conditioner or ventilation duct.
8. Do not allow anything to rest on the power. Do not locate your machine where the cords will be abused by persons walking on them.
9. Do not overload wall outlets and extension cords. This can diminish performance, and may result in the risk of fire or electric shock.
10. Do not allow pets to chew on the AC power, telephone or PC interface cords.
11. Never push objects of any kind into the machine through case or cabinet openings. They may touch dangerous voltage points, creating a risk of fire or shock. Never spill liquid of any kind onto or into the machine.
12. Your machine may have a heavy cover for optimal pressure on the document for the best scanning and/or faxing (usually the flatbed-type machine). In this case, replace the cover after placing document on the scan glass, by holding and moving it down slowly until it seats on its location.
13. To reduce the risk of electric shock, do not disassemble the machine. Take it to a qualified service technician when repair work is required. Opening or removing covers may expose you to dangerous voltages or other risks. Incorrect reassembly could cause electric shock when the unit is subsequently used.
14. Unplug the machine from the telephone jack, PC and AC wall outlet and refer servicing to qualified service personnel under the following conditions:
 - When any part of the power cord, plug or connecting cable is damaged or frayed.
 - If liquid has been spilled into the machine.
 - If the machine has been exposed to rain or water.
 - If the machine does not operate properly after instructions have been followed.
 - If the machine has been dropped, or the cabinet appears damaged.
 - If the machine exhibits a sudden and distinct change in performance.

15. Adjust only those controls covered by the operating instructions. Improper adjustment of other controls may result in damage, and may require extensive work by a qualified service technician to restore the machine to normal operation.
16. Avoid using this machine during a lightning storm. There may be a remote risk of electric shock from lightning. If possible, unplug the AC power and telephone cord for the duration of the lightning storm.
17. SAVE THESE INSTRUCTIONS.
18. Use only No.26 AWG or larger telephone line cord.

Laser Safety Statement

The printer is certified in the U.S. to conform to the requirements of DHHS 21 CFR, chapter 1 Subchapter J for Class I(1) laser products, and elsewhere is certified as a Class I laser product conforming to the requirements of IEC 825.

Class I laser products are not considered to be hazardous. The laser system and printer are designed so there is never any human access to laser radiation above a Class I level during normal operation, user maintenance or prescribed service condition.

WARNING

Never operate or service the printer with the protective cover removed from Laser/Scanner assembly. The reflected beam, although invisible, can damage your eyes.

	CAUTION - CLASS 3B LASER RADIATION WHEN OPEN AVOID EXPOSURE TO THE BEAM.
	DANGER - LASER RADIATION AVOID DIRECT EXPOSURE TO BEAM.
	DANGER - RADIATIONS INVISIBLES DU LASER EN CAS D'OUVERTURE. EVITER TOUTE EXPOSITION DIRECTE AU FAISCEAU.
	VORSICHT - UNSICHTBARE LASERSTRAHLUNG, WENN ABDECKUNG GEÖFFNET. NICHT DEM STRAHL AUSSETZEN.
	ATTENZIONE - RADIAZIONE LASER INVISIBILE IN CASO DI APERTURA. EVITARE L'ESPOSIZIONE AL FASCIO.
	PRECAUCIÓN - RADIACIÓN LASER INVISIBLE CUANDO SE ABRE. EVITAR EXPONERSE AL RAYO.
	PERIGO - RADIAÇÃO LASER INVISÍVEL AO ABRIR. EVITE EXPOSIÇÃO DIRECTA AO FEIXE.
	GEVAAR - ONZICHTBARE LASERSTRALLEN BIJ GEOPENDE KLEP. DEZE KLEP NIET OPENEN.
	ADVARSEL - USYNLIG LASERSTRÁLNING VED ÁBNING. UNNGÁ UDSAETTELSE FOR STRÁLNING.
	ADVARSEL - USYNLIG LASERSTRÁLNING NÁR DEKSEL ÁPNES. UNNGÁ EKSPONERING FOR STRÁLEN.
VARNING - OSYNLIG LASERSTRÁLNING NÁR DENNA DEL ÁR ÖPPEN. STRÁLEN ÁR FARLIG.	
VAROITUS - NÄKYMÄTÖNTÄ LASERSÄTEILYÄ AVATTAESSA. VARO SUORAA ALTISTUMISTA SÄTEELLE.	
注 意 - 严禁揭开此盖, 以免激光泄露灼伤	
주 의 - 이 덮개를 열면 레이저광에 노출될 수 있으므로 주의하십시오.	

Ozone Safety



During normal operation, this machine produces ozone. The ozone produced does not present a hazard to the operator. However, it is advisable that the machine be operated in a well ventilated area.

If you need additional information about ozone, please request your nearest Samsung dealer.

Mercury Safety



LAMP(S) INSIDE THIS PRODUCT CONTAIN MERCURY AND MUST BE RECYCLED OR DISPOSED OF ACCORDING TO LOCAL, STATE OR FEDERAL LAWS. For details see lamprecycle.org, eiae.org, or call 1-800-Samsung

Power Saver

This machine contains advanced energy conservation technology that reduces power consumption when it is not in active use.

When the machine does not receive data for an extended period of time, power consumption is automatically lowered.

The energy star emblem does not represent EPA endorsement of any machine or service.

Recycling



Please recycle or dispose of the packaging material for this product in an environmentally responsible manner.

Correct Disposal of This Product (Waste Electrical & Electronic Equipment)

(Applicable in the European Union and other European countries with separate collection systems)



This marking shown on the product or its literature, indicates that it should not be disposed with other household wastes at the end of its working life. To prevent possible harm to the environment or human health from uncontrolled waste disposal, please separate this from other types of wastes and recycle it responsibly to promote the sustainable reuse of material resources.

Household users should contact either the retailer where they purchased this product, or their local government office, for details of where and how they can take this item for environmentally safe recycling.

Business users should contact their supplier and check the terms and conditions of the purchase contract. This product should not be mixed with other commercial wastes for disposal.

Radio Frequency Emissions

FCC Information to the User

This device complies with Part 15 of the FCC Rules. Operation is subject to the following two conditions:

- This device may not cause harmful interference, and
- This device must accept any interference received, including interference that may cause undesired operation.

This equipment has been tested and found to comply with the limits for a Class B digital device, pursuant to Part 15 of the FCC Rules. These limits are designed to provide reasonable protection against harmful interference in a residential installation. This equipment generates, uses and can radiate radio frequency energy and, if not installed and used in accordance with the instructions, may cause harmful interference to radio communications. However, there is no guarantee that interference will not occur in a particular installation. If this equipment does cause harmful interference to radio or television reception, which can be determined by turning the equipment off and on, the user is encouraged to try to correct the interference by one or more of the following measures:

- Reorient or relocate the receiving antenna.
- Increase the separation between the equipment and receiver.
- Connect the equipment into an outlet on a circuit different from that to which the receiver is connected.
- Consult the dealer or experienced radio TV technician for help.

CAUTION: Change or modifications not expressly approved by the manufacturer responsible for compliance could void the user's authority to operate the equipment.

Canadian Radio Interference Regulations

This digital apparatus does not exceed the Class B limits for radio noise emissions from digital apparatus as set out in the interference-causing equipment standard entitled "Digital Apparatus", ICES-003 of the Industry and Science Canada.

Cet appareil numérique respecte les limites de bruits radioélectriques applicables aux appareils numériques de Classe B prescrites dans la norme sur le matériel brouilleur: "Appareils Numériques", ICES-003 édictée par l'Industrie et Sciences Canada.

Fax Branding

The Telephone Consumer Protection Act of 1991 makes it unlawful for any person to use a computer or other electronic device to send any message via a telephone facsimile machine unless such message clearly contains in a margin at the top or bottom of each transmitted page or on the first page of the transmission the following information:

- (1) the date and time of transmission
- (2) identification of either business, business entity or individual sending the message; and
- (3) telephone number of either the sending machine, business, business entity or individual.

The Telephone Company may make changes in its communications facilities, equipment operations or procedures where such action is reasonably required in the operation of its business and is not inconsistent with the rules and regulations in FCC Part 68. If such changes can be reasonably expected to render any customer terminal equipment incompatible with telephone company communications facilities, or require modification or alteration of such terminal equipment, or otherwise materially affect its use or performance, the customer shall be given adequate notice in writing, to allow the customer an opportunity to maintain uninterrupted service.

Ringer Equivalence Number

The Ringer Equivalence Number and FCC Registration Number for this machine may be found on the label located on the bottom or rear of the machine. In some instances you may need to provide these numbers to the telephone company.

The Ringer Equivalence Number (REN) is a measure of the electrical load placed on the telephone line, and is useful for determining whether you have "overloaded" the line. Installing several types of equipment on the same telephone line may result in problems making and receiving telephone calls, especially ringing when your line is called. The sum of all Ringer Equivalence Numbers of the equipment on your telephone line should be less than five in order to assure proper service from the telephone company. In some cases, a sum of five may not be usable on your line. If any of your telephone equipment is not operating properly, you should immediately remove it from your telephone line, as it may cause harm to the telephone network.

WARNING:

FCC Regulations state that changes or modifications to this equipment not expressly approved by the manufacturer could void the user's authority to operate this equipment. In the event that terminal equipment causes harm to the telephone network, the telephone company should notify the customer that service may be stopped. However, where prior notice is impractical, the company may temporarily cease service, providing that they:

- a) promptly notify the customer.
- b) give the customer an opportunity to correct the equipment problem.
- c) inform the customer of the right to bring a complaint to the Federal Communication Commission pursuant to procedures set out in FCC Rules and Regulations Subpart E of Part 68.

You should also know that:

- Your machine is not designed to be connected to a digital PBX system.
- If you intend to use a computer modem or fax modem on the same phone line as your machine, you may experience transmission and reception problems with all the equipment. It is recommended that no other equipment, except for a regular telephone, share the line with your machine.
- If your area experiences a high incidence of lightning or power surges, we recommend that you install surge protectors for both the power and the telephone lines. Surge protectors can be purchased from your dealer or telephone and electronic specialty stores.
- When programming emergency numbers and/or making test calls to emergency numbers, use a non-emergency number to advise the emergency service dispatcher of your intentions. The dispatcher will give you further instructions on how to actually test the emergency number.
- This machine may not be used on coin service or party lines.
- This machine provides magnetic coupling to hearing aids.
- You may safely connect this equipment to the telephone network by means of a standard modular jack, USOC RJ-11C.

Declaration of Conformity (European Countries)

Approvals and Certifications



The CE marking applied to this product symbolizes Samsung Electronics Co., Ltd. Declaration of Conformity with the following applicable 93/68/EEC Directives of the European Union as of the dates indicated:

January 1, 1995: Council Directive 73/23/EEC Approximation of the laws of the member states related to low voltage equipment.

January 1, 1996: Council Directive 89/336/EEC (92/31/EEC), approximation of the laws of the Member States related to electromagnetic compatibility.

March 9, 1999: Council Directive 1999/5/EC on radio equipment and telecommunications terminal equipment and the mutual recognition of their conformity.

A full declaration, defining the relevant Directives and referenced standards can be obtained from your Samsung Electronics Co., Ltd. representative.

EC Certification

Certification to 1999/5/EC Radio Equipment & Telecommunications Terminal Equipment Directive (FAX)

This Samsung product has been self-certified by Samsung for pan-European single terminal connection to the analogue public switched telephone network (PSTN) in accordance with Directive 1999/5/EC. The product has been designed to work with the national PSTNs and compatible PBXs of the European countries:

In the event of problems, you should contact the Euro QA Lab of Samsung Electronics Co., Ltd. in the first instance.

The product has been tested against TBR21. To assist in the use and application of terminal equipment which complies with this standard, the European Telecommunication Standards Institute (ETSI) has issued an advisory document (EG 201 121) which contains notes and additional requirements to ensure network compatibility of TBR21 terminals. The product has been designed against, and is fully compliant with, all of the relevant advisory notes contained in this document.

Replacing the Fitted Plug (for UK Only)

IMPORTANT

The mains lead for this machine is fitted with a standard (BS 1363) 13 amp plug and has a 13 amp fuse. When you change or examine the fuse, you must re-fit the correct 13 amp fuse. You then need to replace the fuse cover. If you have lost the fuse cover, do not use the plug until you have another fuse cover.

Please contact the people from you purchased the machine.

The 13 amp plug is the most widely used type in the UK and should be suitable. However, some buildings (mainly old ones) do not have normal 13 amp plug sockets. You need to buy a suitable plug adaptor. Do not remove the moulded plug.

WARNING

If you cut off the moulded plug, get rid of it straight away.

You cannot rewire the plug and you may receive an electric shock if you plug it into a socket.

IMPORTANT WARNING: You must earth this machine.

The wires in the mains lead have the following color code:

- Green and Yellow: Earth
- Blue: Neutral
- Brown: Live

If the wires in the mains lead do not match the colors marked in your plug, do the following:

You must connect the green and yellow wire to the pin marked by the letter "E" or by the safety 'Earth symbol' or colored green and yellow or green.

You must connect the blue wire to the pin which is marked with the letter "N" or colored black.

You must connect the brown wire to the pin which is marked with the letter "L" or colored red.

You must have a 13 amp fuse in the plug, adaptor, or at the distribution board.



ELECTRONICS

EU Declaration of Conformity (RTTE)

We, Samsung Electronics Co, Ltd.

Shandong Samsung Telecommunications Co., Ltd. Sanxing Road,
Weihai Hi-Tech, IDZ Shandong Province, China 264209

(factory name, address)

declare under our sole responsibility that the product

Multi-function Printer
model "RK20MFF"

to which this declaration relates is in conformity with

R&TTE Directive 1999/5/EC (Annex II)
Low Voltage Directive 73/23/EEC
EMC Directive 89/336/EEC, 92/31/EEC

By application of the following standards

R&TTE : TBR 21, EG 201 121 V1.1.3

.....
LVD : EN 60950-1:2001

.....
EMC : EN55022:1998 EN55024:1998 + A1:2001, EN61000-3-2:2000,

.....
EN61000-3-3:1995 + A1:2001
.....

(Manufacturer)

Samsung Electronics co.,Ltd
#259, KongDan-Dong, GuMi-City
KyungBuk, Korea 730-030

2005-08-04

.....
(place and date of issue)

Whan-Soon Yim / General Manager

.....
(name and signature of authorized person)

(Representative in the EU)

Samsung Electronics Euro QA Lab.
Blackbushe Business Park
Saxony Way, Yateley, Hampshire
GU46 6GG, UK

2005-08-05

.....
(place and date of issue)

Yong-Sang Park / Manager

.....
(name and signature of authorized person)

Differences Between British and American English

British English	American English
(Re)dialling	(Re)dialing
Colour	Color
Emphasise	Emphasize
Recognise	Recognize
Organise	Organize
Authorise	Authorize
Cancelling	Canceling
Customise	Customize
Grey	Gray

1

INTRODUCTION

Thank you for purchasing this Samsung multifunctional product. Your machine provides printing, copying, scanning, and faxing functions!

This chapter includes:

- **Special Features**
- **Understanding Component Locations**

Special Features

Your new machine is equipped with special features that improve the print quality. You can:

Print with excellent quality and speed

1200  DPI

- You can print up to **1200 dpi [Best]**. See page 4.8.
- Your machine prints A4-sized paper at up to 20 ppm and letter-sized paper at up to 20 ppm (pages per minute).

Handle paper flexibly

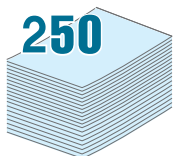

- **Multipurpose Tray** supports letterhead, envelopes, labels, transparencies, custom-sized materials, postcards, and heavy paper. A 50-sheet **Multipurpose Tray** supports plain paper.
- The **Standard 250-sheet input tray** (Tray1) and **optional 250-sheet input tray** (Tray2) supports A4/letter-sized paper.

Create professional documents

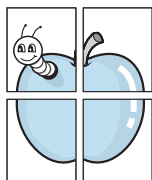

- Print **Watermarks**. You can customize your documents with words, such as "Confidential." See page 4.18.
- Print **Posters**. The text and pictures of each page of your document are magnified and printed across the sheet of paper and taped together to form a poster. See page 4.14.

Save time and money

- You can print multiple pages on one single sheet of paper to save paper.
- You can use preprinted forms and letterhead on plain paper. See "Using Overlays" on page 4.21
- This machine automatically **conserves electricity** by substantially reducing power consumption when not printing.
- This machine meets **Energy Star** guidelines for energy efficiency.

Expand the machine capacity

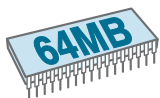

- This machine has 64 MB of memory which can be expanded to 192 MB.
- You can install an optional 250-sheet tray in your machine. This tray reduces how often you have to add paper to the machine.
- A Network interface enables network printing.

Print in various environments



- You can print in **Windows 98/Me/NT 4.0/2000/XP**.
- Your machine is compatible with various **Linux**.
- Your machine comes with both the **USB** and **Parallel** interface.
- You can also use a **Network interface**.

Use a USB flash drive



If you have a USB flash drive, you can use it in various ways with your machine.

- You can scan documents and save them on the USB flash drive.
- You can directly print data stored on the USB flash drive.
- You can manage the USB flash drive.
- You can back up data and restore backup files to the machine's memory.

Understanding Component Locations

These are the main components of your machine:

Front View

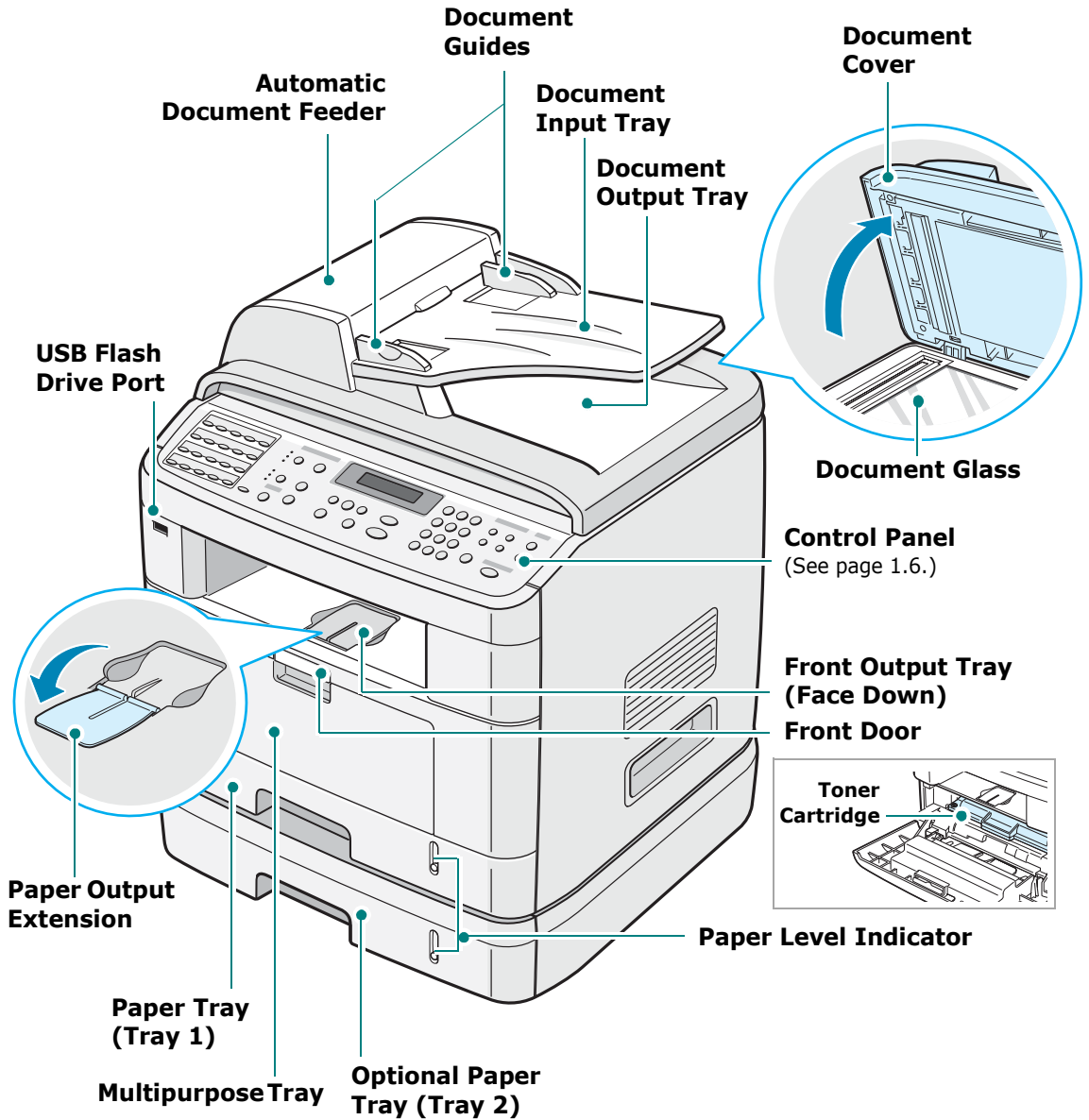

Rear View

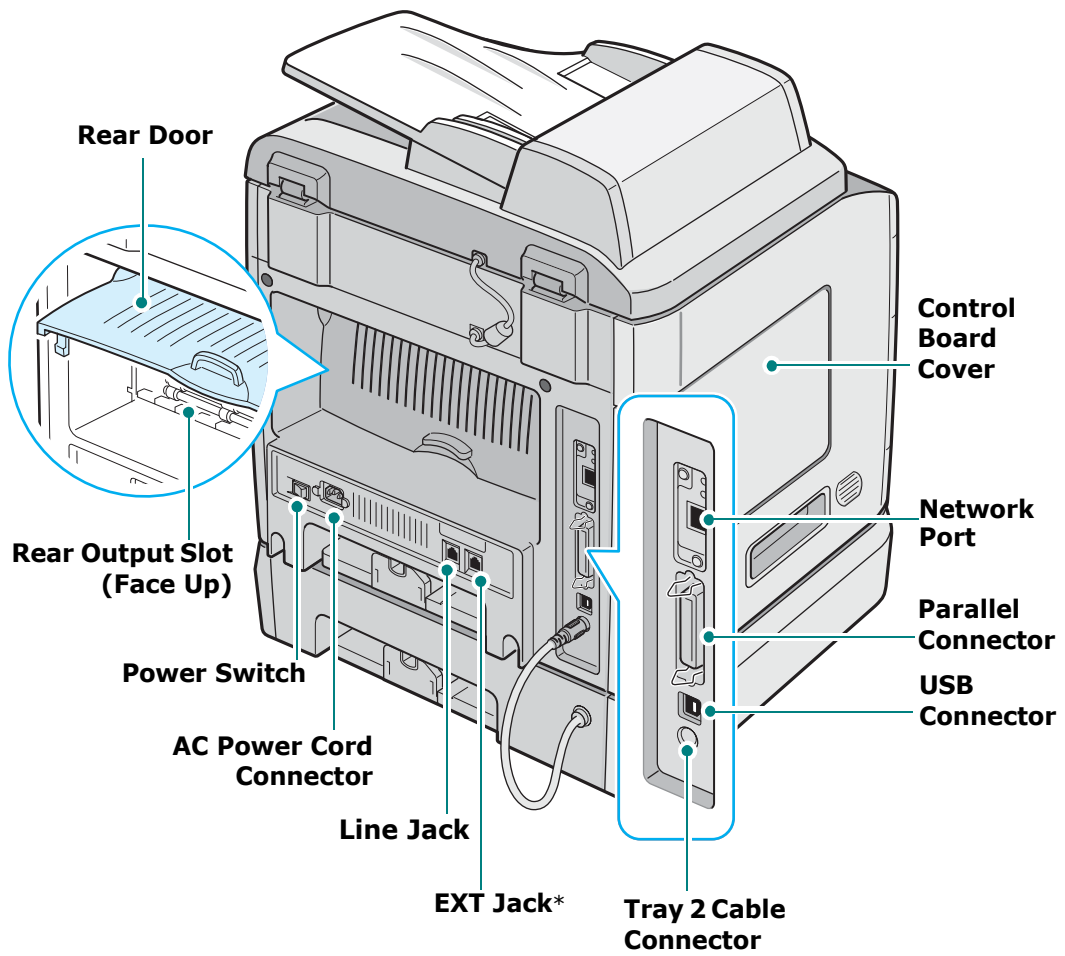





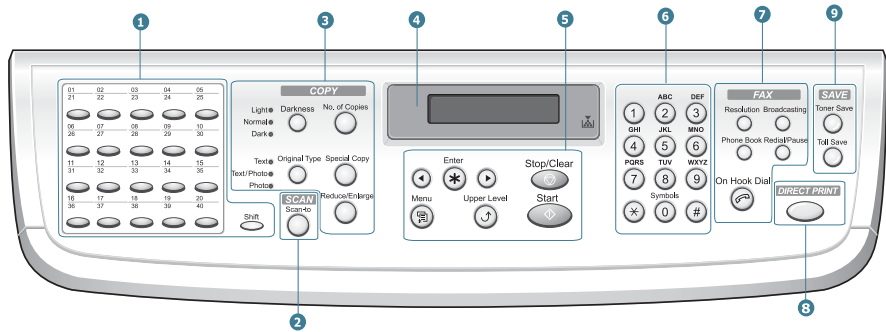









* If your country has a different telephone connection system, this socket may be blocked.

Control Panel Functions



1		Allows you to store frequently-dialed fax numbers and dial them with the touch of a few buttons.
		Allows you to shift the one-touch buttons to the numbers 21 through 40.
2 S C A N		Allows you to access a list of your PC software programs that an image can be scanned to. You must create the scan list using the Samsung software (Printer Settings Utility) provided with this machine. Also allows you to scan and save documents in a USB flash drive, and manage it when it is inserted into the USB port of your machine. See Chapter 10, Installing a USB Flash Drive.
		Adjusts the brightness of the documents for the current copy job.
3 C O P Y		Selects the document type for the current copy job.
		Selects the number of copies.
		Allows you to use special copy features, such as Clone, Collation, Auto Fit, 2 Sides on 1 page, 2/4 Up (multiple pages on a sheet), and Poster copying.
		Makes a copy smaller or larger than the original.
4		Displays the current status and prompts during an operation.
		Turns on when the toner cartridge is empty.
5		Uses to scroll through the available options for the selected menu item.

5		Confirms the selection on the display.
		Enters Menu mode and scrolls through the menus available.
		Sends you back to the upper menu level.
		Stops an operation at any time. In Standby mode, clears/cancels the copy options, such as the darkness, the document type setting, the copy size, and the number of copies.
		Starts a job.
6		Dials a number or enters alphanumeric characters.
7 F A X		Adjusts the resolution of the documents for the current fax job.
		Allows you to send a fax to multiple destinations.
		Allows you to store frequently-dialed fax numbers as one or two-digit speed dial or group dial numbers for automatic dialing and edit the stored numbers. Also allows you to print a Phonebook list.
		In Standby mode, redials the last number or in Edit mode, inserts a pause into a fax number.
		Engages the telephone line.
8		Allows you to directly print files stored on a USB flash drive when it is inserted into the USB port in the front of your machine.
9 S A V E		Allows you to save on toner by using less toner to print a document.
		Allows you to save on call costs by sending a fax at a preset toll-saving time. Using this feature, you can take advantage of lower long distance rates at night, for example.

MEMO



2

GETTING STARTED

This chapter gives you step-by-step instructions for setting up your machine.

This chapter includes:

- **Setting Up Your Machine**

- Unpacking
- Installing the Toner Cartridge
- Loading Paper
- Making Connections
- Turning the Machine On

- **Setting Up the Machine System**

- Changing the Display Language
- Setting the Machine ID
- Setting the Date and Time
- Setting the Paper Size and Type
- Setting Sounds
- Using the Save Modes

- **Installing Software**

- About Samsung Software
- Installing Samsung Software in Windows
- Repairing Software
- Removing Software
- Using the Printer Settings Utility

Setting Up Your Machine

Unpacking

- 1 Remove the machine and all accessories from the packing carton. Make sure that the machine has been packed with the following items:



Starter Toner Cartridge

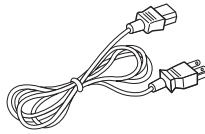

AC Power Cord*

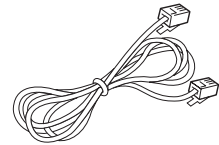

Telephone Line Cord*

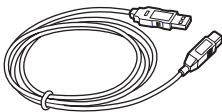

USB Cable



Quick Install Guide

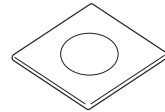

Printer CD-ROM**

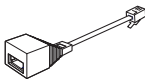

TAM Lead (for UK only)

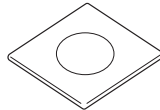

**Network Utilities
CD-ROM**



**Network Printer Quick
Guide**

*The appearance of the power cord and the telephone line cord may differ depending on your country's specifications.

**The CD-ROM contains the Samsung printer drivers, Scan drivers, Printer Settings Utility, SmarThru software, the Network Scan drivers, the Set IP, the user's guide, and the Adobe Acrobat Reader program.



NOTES:

- Components may differ from country to country.
 - You should use the telephone line cord which is supplied with your machine. If you are replacing it with another vendor's, it should be AWG #26 or larger telephone line cord.
 - Power cord must be plugged into a grounded power socket.
-

2 Remove the packing tape from the front, back, and sides of the machine.

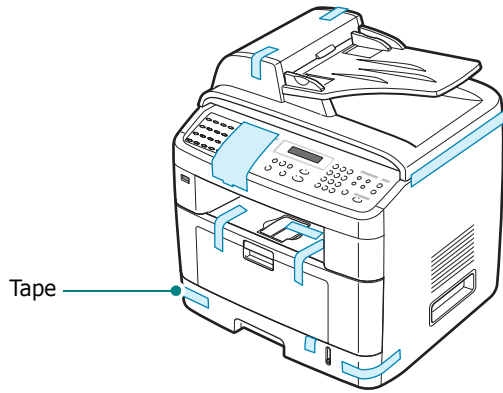

3 Gently pull the scan lock label until it comes away from the machine. This will pull the scanner locking switch into the FORWARD (Unlocked) position automatically.

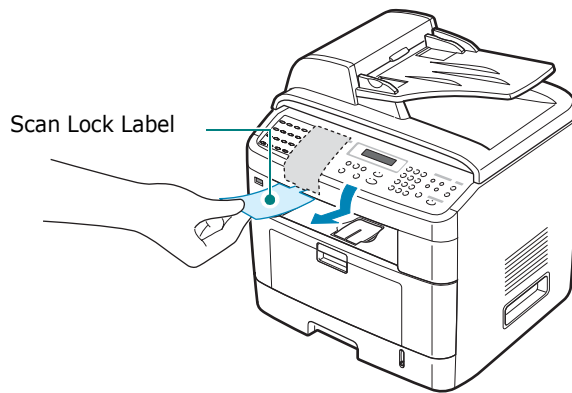

NOTE: When you are moving the machine or do not intend to use it for a long period of time, move the scanner locking switch BACKWARD to the lock position, as shown. To scan or copy a document, the switch must be unlocked.

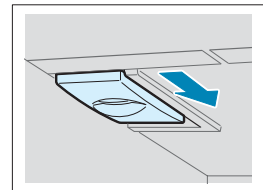

Selecting a Location

Select a level, stable place with adequate space for air circulation. Allow extra space for opening doors and trays.

The area should be well-ventilated and away from direct sunlight or sources of heat, cold, and humidity. Do not set the machine close to the edge of your desk or table.

Clearance Space

- **Front:** 482.6 mm (enough space so that the paper tray can be removed)
- **Back:** 100 mm (enough space for ventilation)
- **Right:** 100 mm
- **Left:** 100 mm (enough space for ventilation)

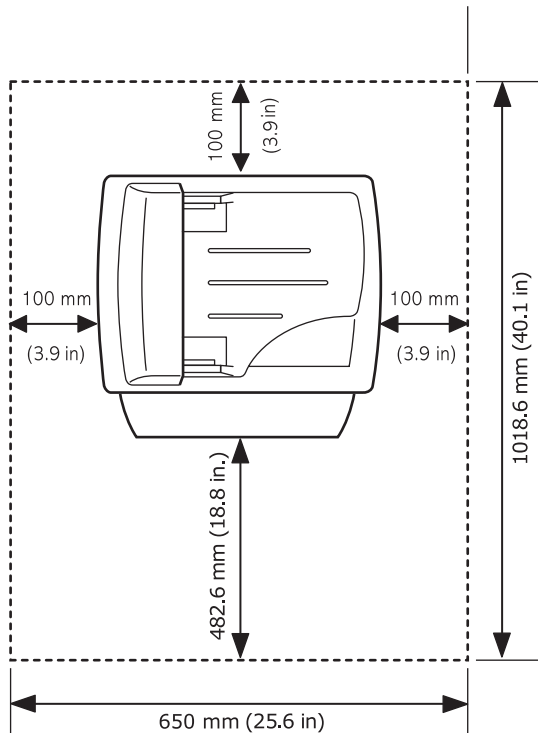

Installing the Toner Cartridge

- 1 Open the front door.

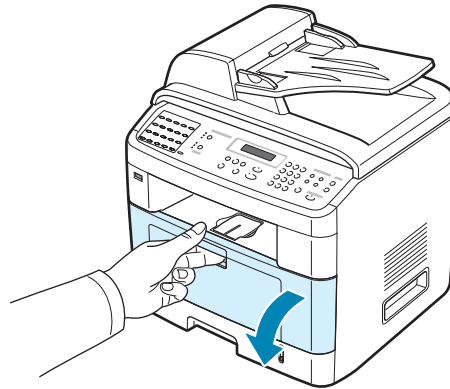

- 2 Remove the starter toner cartridge from its bag. Gently roll the cartridge 5 or 6 times to distribute the toner.

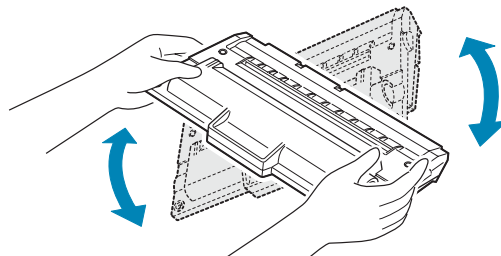

Thoroughly rolling the cartridge will assure maximum copies per cartridge.



NOTE: If toner gets on your clothing, wipe it off with a dry cloth and wash clothing in cold water. Hot water sets toner into fabric.



CAUTIONS:

- To prevent damage, do not expose the toner cartridge to light for more than a few minutes. Cover it with a piece of paper, if left exposed for more than a few minutes.
 - Do not touch the green underside of the toner cartridge. Use the handle on the cartridge to avoid touching this area.
-

- 3 Hold the toner cartridge by the handle. Slowly insert the cartridge into the opening in the machine. Tabs on the sides of the cartridge and corresponding grooves within the machine will guide the cartridge into the correct position until it locks into place completely.

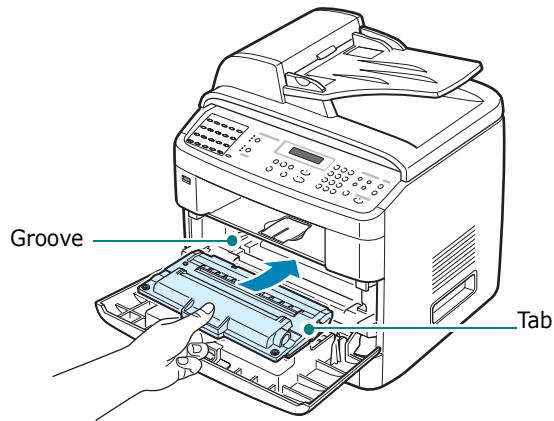

- 4 Close the front door. Make sure that the door is securely closed.

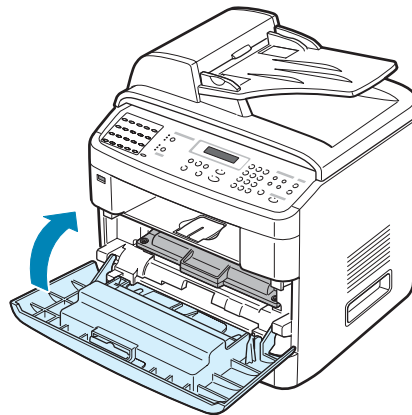

NOTE: When printing text at 5% coverage, you can expect a toner cartridge life of approximately 5,000 or 3,000 pages. (3,000 pages for the toner cartridge that is shipped with the machine.)

Loading Paper

The paper tray can hold a maximum of 250 sheets of 20 lb plain paper.

- 1 Pull open the paper tray and remove it from the machine.

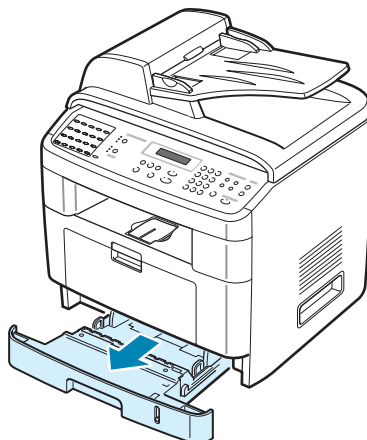

- 2 Fan the edges of the paper stack to separate the pages. Then tap the stack on a flat surface to even it up.

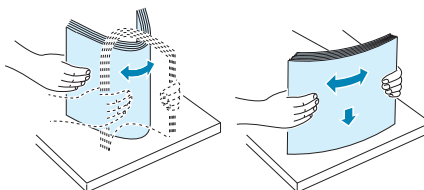

- 3 Insert the paper stack into the paper tray **with the side to be printed on facing down**.

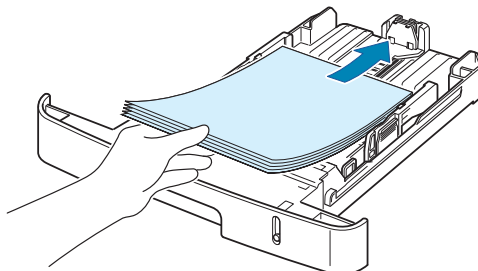

NOTE: If you want to load a different sized paper, you need to adjust the paper guides. For details, see page 2.9.

- 4 Pay attention to the paper limit mark on both inside walls of the tray. Paper overloading may cause paper jams.

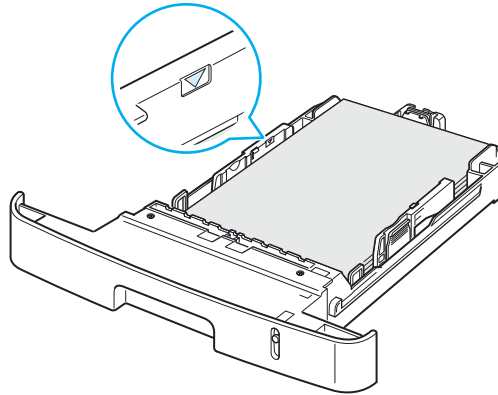

- 5 Insert and slide the paper tray back into the machine.

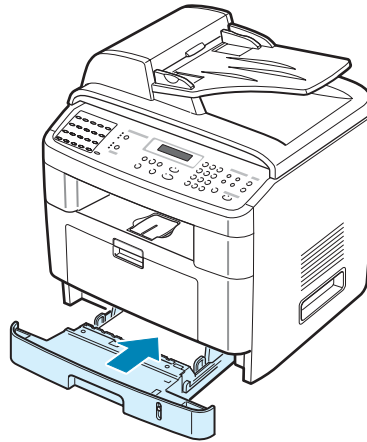

NOTE: After you load paper, you need to set up your machine for the paper type and size you loaded. See page 2.20 for copying and faxing, or page 4.6 for PC-printing. The settings made from the printer driver override the settings on the control panel.

Changing the Size of the Paper in the Paper Tray

To load longer sizes of paper, such as Legal-sized paper, you need to adjust the paper guides to extend the paper tray.

- 1 After pressing and unlatching the guide lock, slide the paper length guide out completely to extend the paper tray to its full length.

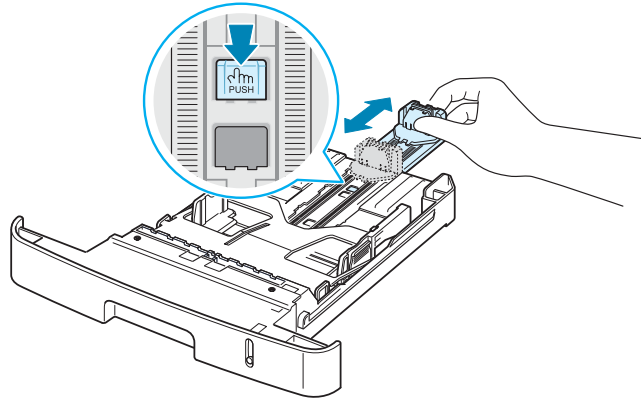

- 2 After inserting paper into the tray, squeeze the length guide and slide it until it lightly touches the end of the paper stack.

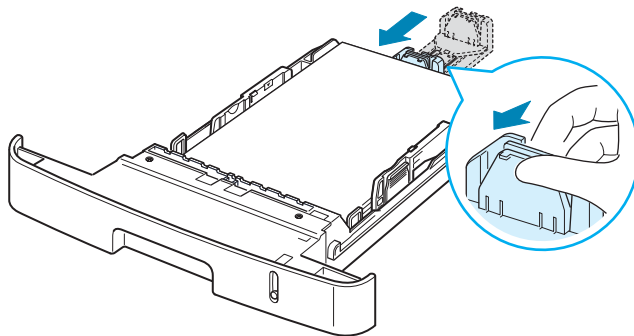

For paper smaller than Letter size, adjust the front paper length guide so that it lightly touches the paper stack.

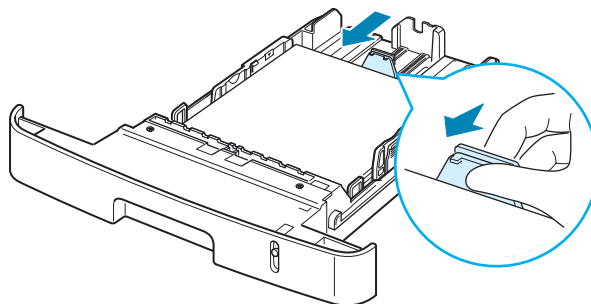

- 3 Squeeze the width guide, as shown and slide it to the stack of paper until it lightly touches the side of the stack.

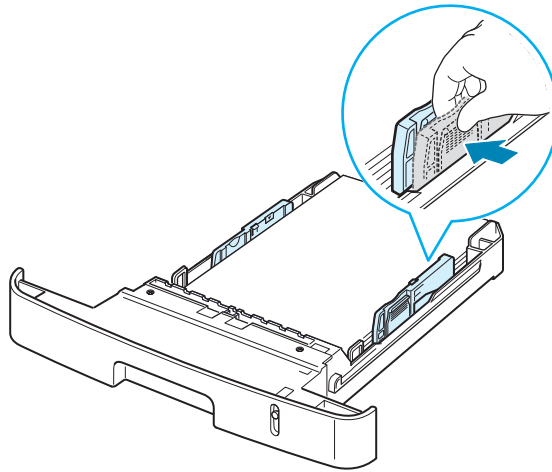

NOTES:

- Do not push the paper width guide far enough to cause the materials to warp.
- If you do not adjust the paper width guide, it may cause paper jams.

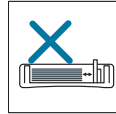
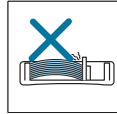
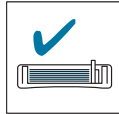

Making Connections

- 1 Plug one end of the supplied telephone line cord into the **LINE** jack on the machine and the other end into the wall jack.

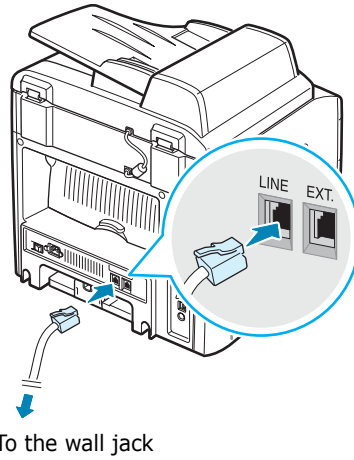

If you want to use your machine to receive both faxes and voice calls, you will need to connect a telephone and/or answering machine to your machine.

Plug your extension phone or answering machine card into the **EXT** jack, as shown below.

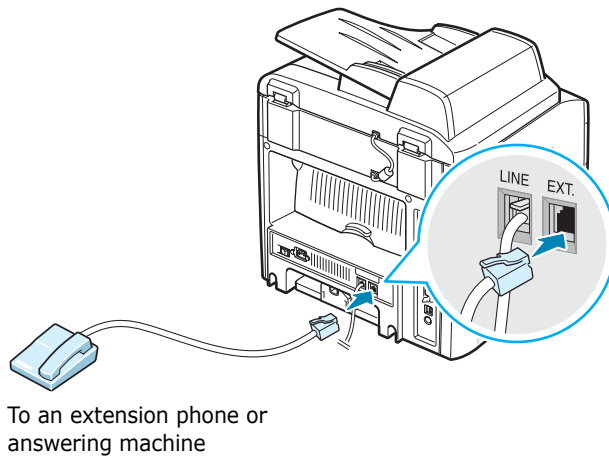

UK users should plug the cord of the extension phone into the supplied TAM lead and plug the cord of the TAM lead into the **EXT** jack on the back of your machine.

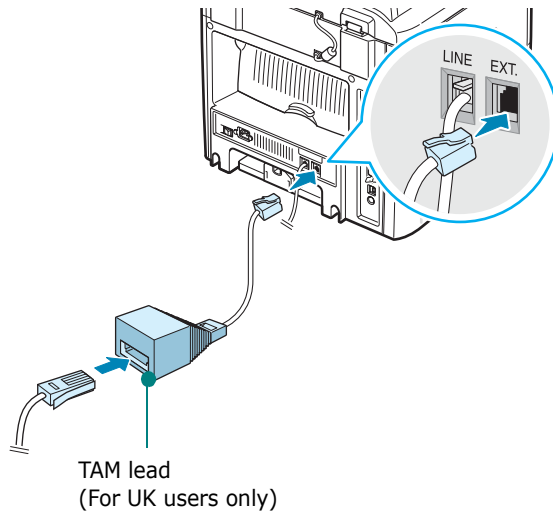

NOTES:

- Use the TAM lead and the telephone line cord supplied with your machine.
- In the United Kingdom, if a three-wire type (SHUNT-wire, older equipment) telephone or answering machine is connected to the EXT jack on the machine, the external equipment will fail to ring when receiving an incoming call as the machine is designed to operate with the latest technology. To prevent this incompatibility, use two-wire (newer equipment) telephones or answering machines.

- 2 Connect a USB cable to the USB connector on your machine. You need to buy a USB 2.0 compliant cable that is within 3 m in length

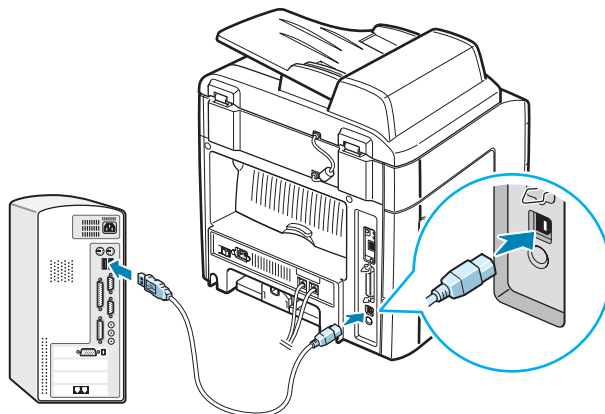

If you want to use a parallel printer cable, purchase only an IEEE-1284 compliant parallel cable and connect it to the parallel connector on your machine.

Push the metal clips down to fit inside the notches on the cable plug.

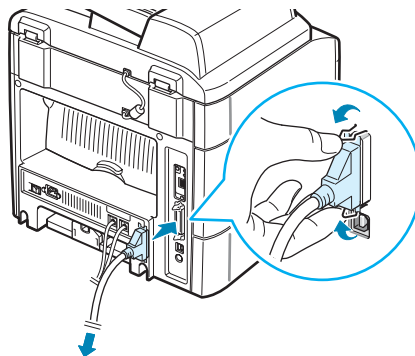

To the parallel port on your computer



NOTES:

- You only need to connect one of the cables mentioned above. Do not use the parallel and the USB cables at the same time.
 - If you are using a USB cable, you must be running Windows 98/Me/2000/XP, or Linux.
 - The parallel port may not be available depending on your country.
-

If you want to use a network cable, plug one end of the Ethernet cable (UTP cable with RJ.45 connector) into the Ethernet network port on the machine and the other end of the cable into a network LAN connection.

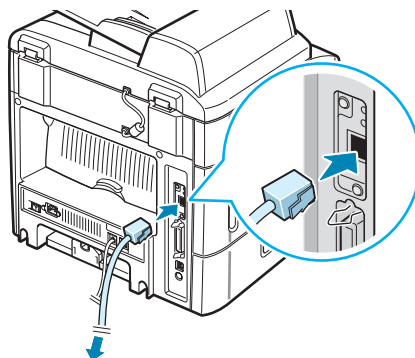

To the network LAN connection



NOTE: You can configure the network parameters using the control panel; see page B.5.

Turning the Machine On

- 1 Plug one end of the supplied three-pronged electrical cord into the AC socket on the machine and the other end into a properly grounded AC outlet.
- 2 Press the power switch to turn the machine on. "Warming Up Please Wait" appears on the display indicating that the machine is now on.

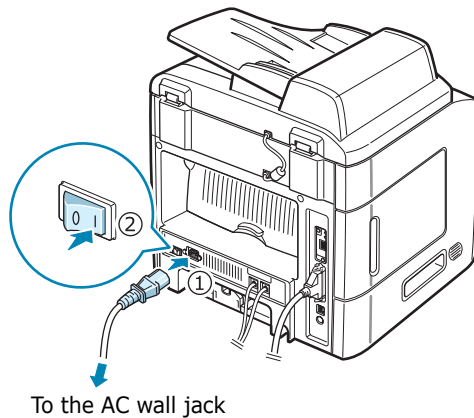

To view your display text in another language, see page 2.15.



CAUTIONS:

- The fuser area inside of the rear door of your machine becomes very hot when in use. Take care not to burn your fingers when you access this area.
 - Do not disassemble the machine with power on. If you do, you may receive an electric shock.
-

Setting Up the Machine System

Changing the Display Language

To change the language that displays on the control panel, follow these steps:

- 1** Press **Menu** until "Machine Setup" appears on the top line of the display.
- 2** Press the scroll button (◀ or ▶) until "Language" appears on the bottom line of the display.
- 3** Press **Enter**. The current setting appears on the bottom line of the display.
- 4** Press the scroll button (◀ or ▶) until the language you want appears on the display.
- 5** Press **Enter** to save the selection.
- 6** To return to Standby mode, press **Stop/Clear**.

Setting the Machine ID

In some countries, you are required by law to indicate your fax number on any fax you send. The Machine ID, containing your telephone number and name (or company name), will be printed at the top of each page sent from your machine.

- 1 Press **Menu** until "Machine Setup" appears on the top line of the display. The first available menu item, "Machine ID," displays on the bottom line.
- 2 Press **Enter**. The display asks you to enter the fax number. If there is a number already set, the number appears.
- 3 Enter your fax number using the number keypad.



NOTE: If you make a mistake while entering numbers, press the ◀ button to delete the last digit.

- 4 Press **Enter** when the number on the display is correct. The display asks you to enter an ID.
- 5 Enter your name or the company name using the number keypad.

You can enter alphanumeric characters using the number keypad, and include special symbols by pressing the **0** button.

For details on how to use the number keypad to enter alphanumeric characters, see "Entering Characters Using the Number Keypad" on page 2.17.

If you want to enter the same letter or number in succession (e.g. SS, AA, 777), enter one digit, move the cursor by pressing the ▶ button and enter the next digit.

If you want to insert a space in the name, you can also use the ▶ button to move the cursor to skip the position.

- 6 Press **Enter** when the name on the display is correct.
- 7 To return to Standby mode, press **Stop/Clear**.

Entering Characters Using the Number Keypad

As you perform various tasks, you need to enter names and numbers. For example, when you set up your machine, you enter your name (or your company's name) and telephone number. When you store one-, two-, or three-digit speed dial or group dial numbers, you may also enter the corresponding names.

To enter alphanumeric characters:

- 1 When you are prompted to enter a letter, locate the button labeled with the character you want. Press the button until the correct letter appears on the display.

For example, to enter the letter **O**, press **6**, labeled with "MNO."

Each time you press **6**, the display shows a different letter, **M**, **N**, **O**, and finally **6**.



You can enter special characters, such as space, plus sign, and etc.. For details, see "Keypad Letters and Numbers" on page 2.18.

- 2 To enter additional letters, repeat step 1.

If the next letter is printed on the same button, move the cursor by pressing the ► button and then press the button labeled with the letter you want. The cursor will move to the right and the next letter will appear on the display.

You can enter a space by pressing **1** twice.

- 3 When you finish entering letters, press **Enter**.

Keypad Letters and Numbers

Key	Assigned numbers, letters, or characters
1	1 Space
2	A B C 2
3	D E F 3
4	G H I 4
5	J K L 5
6	M N O 6
7	P Q R S 7
8	T U V 8
9	W X Y Z 9
0	+ - , . ' / * # & 0

Changing Numbers or Names

If you make a mistake while entering a number or name, press the **◀** button to delete the last digit or character. Then enter the correct number or character.

Inserting a Pause

With some telephone systems, you must dial an access code (9, for example) and listen for a second dial tone. In such cases, you must insert a pause in the telephone number. You can insert a pause while you are setting up one-touch or speed dial numbers.

To insert a pause, press **Redial/Pause** at the appropriate place while entering the telephone number. A “-” appears on the display at the corresponding location.

Setting the Date and Time

The current date and time are shown on the display when your machine is on and ready to work. This machine, all of your faxes will have the date and time printed on them.



NOTE: When turning on the machine after turning it off for a long time, you need to reset date and time.

- 1 Press **Menu** until "Machine Setup" appears on the top line of the display.
- 2 Press the scroll button (◀ or ▶) to display "Date & Time" on the bottom line and press **Enter**.
- 3 Enter the correct time and date using the number keypad.

Month	= 01 ~ 12
Day	= 01 ~ 31
Year	= requires four digits
Hour	= 01 ~ 12 (12-hour mode) 00 ~ 23 (24-hour mode)
Minute	= 00 ~ 59



NOTE: The date format may differ from country to country.

You can also use the scroll button (◀ or ▶) to move the cursor under the digit you want to correct and enter a new number.

- 4 To select "AM" or "PM" for 12-hour format, press the * or # button or any number button.

When the cursor is not under the AM or PM indicator, pressing the * or # button immediately moves the cursor to the indicator.

You can change the clock mode to 24-hour format (e.g. 01:00 PM as 13:00). For details, see page 2.20.

- 5 Press **Enter** when the time and date on the display is correct.

When you enter a wrong number, the machine beeps and does not proceed to the next step. If this happens, just reenter the correct number.

Changing the Clock Mode

You can set your machine to display the current time using either a 12-hour or 24-hour format.

- 1 Press **Menu** until "Machine Setup" appears on the top line of the display.
- 2 Press the scroll button (◀ or ▶) until you see "Clock Mode" on the bottom line and press **Enter**.
The clock mode currently set for the machine displays.
- 3 Press the scroll button (◀ or ▶) to select the other mode and then press **Enter** to save the selection.
- 4 To return to Standby mode, press **Stop/Clear**.

Setting the Paper Size and Type

After loading paper in the paper tray, the standard Tray1, Multipurpose tray, or optional Tray2, you need to set the paper size and type using the control panel buttons. These settings will apply to copy and fax modes. For PC-printing, you need to select the paper size and type in the application program you use on your PC.

- 1 Press **Menu**.
The display shows "Paper Setting" on the top line of the display.
- 2 Press the scroll button (◀ or ▶) to display "Paper Size" on the bottom line and press **Enter** to access the menu item.
The first item, "Tray Paper," displays on the bottom line.
If the optional Tray 2 is installed, "Tray1 Size" displays on the bottom line.
- 3 Use the scroll button (◀ or ▶) to select the paper tray you want to use and press **Enter**.
- 4 Use the scroll button (◀ or ▶) to find the paper size you are using and press **Enter** to save it.
- 5 Press **Upper Level**.

- 6 Press the ► button to scroll to "Paper Type" and press **Enter** to access the menu item.
- 7 Use the scroll button (◀ or ►) to find the paper type you are using and press **Enter** to save it.
- 8 To return to Standby mode, press **Stop/Clear**.

Setting Sounds

You can control the following sounds:

- **Speaker:** You can turn on or off the sounds from the telephone line through the speaker, such as the dial tone or a fax tone. With this option set to "Comm." the speaker is on until the remote machine answers.
- **Ringer:** You can adjust the ringer volume.
- **Key Sound:** With this option set to "On" a key tone sounds each time a key is pressed.
- **Alarm Sound:** You can turn the alarm sound on or off. With this option set to "On" an alarm tone sounds when an error occurs or fax communication ends.
- You can adjust the volume level using the **On Hook Dial** button.

Speaker, Ringer, Key Sound, and Alarm Sound

- 1 Press **Menu** until "Sound/Volume" appears on the top line of the display.
- 2 Press the scroll button (◀ or ►) to scroll through the options. Press **Enter** when you see the desired sound option.
- 3 Press the scroll button (◀ or ►) to display the desired status or volume for the option you have selected.

You will see the selection on the bottom line of the display.

For the ringer volume, you can select "Off," "Low," "Med," and "High." Setting "Off" means that the ringer does not sound. The machine works normally even if the ringer is turned off.

- 4 Press **Enter** to save the selection. The next sound option appears.
- 5 If necessary, repeat steps 2 through 4.
- 6 To return to Standby mode, press **Stop/Clear**.

Speaker Volume

- 1 Press **On Hook Dial**. A dial tone sounds from the speaker.
- 2 Press the scroll button (◀ or ▶) until you hear the volume you want. The display shows the current volume level.
- 3 Press **On Hook Dial** to save the change and return to Standby mode.



NOTE: You can adjust the speaker volume only when the telephone line is connected.

Using the Save Modes

Toner Save Mode

Toner Save mode allows your machine to use less toner on each page. Activating this mode extends the life of the toner cartridge beyond what one would experience in the normal mode, but it reduces print quality.

To turn the toner save mode on or off, press **Toner Save**.

- If the button backlight is on, the mode is active and the machine uses less toner when printing a document.
- If the button backlight is off, the mode is deactivated and the machine prints with the normal quantity of toner.



NOTE: When PC-printing, you can also turn on or off the toner save mode in the printer properties. See page 4.8.

Toll Save Mode

Using the **Toll Save** button on the control panel, you can quickly set your machine to send the document(s) stored in memory during a preset time slot, when the call charge is lower. This Toll Save mode helps you to take advantage of lower long distance rates at night, for example.



NOTE: The toll-saving time slot may vary depending on your contract with your long distance phone company.

To turn the toll save mode on:

- 1** Press **Toll Save**. The button backlight turns on.
- 2** Press **Enter** when "Start Time" displays on the bottom line.
- 3** Enter the time and date when your machine starts sending toll save faxes, using the number keypad.

To select "AM" or "PM" for 12-hour format, press the * or # button or any number button.

- 4** Press **Enter** when the start time and date on the display is correct.

- 5 Press the scroll button (◀ or ▶) to display "End Time" and press **Enter**.
- 6 Enter the time and date when the toll save transmission ends, using the number keypad.
- 7 Press **Enter** to save the setting.
- 8 To return to Standby mode, press **Stop/Clear**.

Once Toll Save mode is activated, your machine stores into memory all of the documents to be faxed and sends them at the programmed time.

To turn Toll Save mode off, press **Toll Save** again. The button backlight turns off and the mode is deactivated.



NOTE: Once the toll-saving time is set, the **Toll Save** button allows you only to enable or disable the toll save mode. To change the time setting, use the **Toll Save** item in the **Advanced Fax** menu. See page 7.37.

Power Save Mode

Power Save mode allows your machine to reduce power consumption when it is not in actual use. You can turn this mode on and select a length of time for which the machine waits after a job is printed before it switches to a reduced power state.

- 1 Press **Menu** until "Machine Setup" appears on top line of the display.
- 2 Press the scroll button (◀ or ▶) until "Power Save" appears on the bottom line. Press **Enter**.
- 3 Press the scroll button (◀ or ▶) to display "On" on the bottom line and press **Enter**.

Selecting "Off" means that the power save mode is deactivated.

- 4 Press the scroll button (◀ or ▶) until the time setting you want appears.
The available options are 5, 10, 15, 30, and 45 (minutes).
- 5 Press **Enter** to save the selection.
- 6 To return to Standby mode, press **Stop/Clear**.

Scan Lamp Save Mode

Scan Lamp Save mode allows you to save the scan lamp. The scan lamp under the document glass automatically turns off when it is not in actual use to reduce power consumption and extend the life of the lamp. The lamp automatically wakes up after some warm-up time when you start scanning.

You can set the length of time for which the scan lamp waits after a scan job is completed before it switches to the power save mode.

- 1** Press **Menu** until "Machine Setup" appears on top line of the display.
- 2** Press the scroll button (◀ or ▶) until "Scan PWR Save" appears on the bottom line. Press **Enter**.
- 3** Press the scroll button (◀ or ▶) until the time setting you want appears on the bottom line.
The available time options are 0.5, 1, 4, 8, and 12 (hours).
- 4** Press **Enter** to save the selection.
- 5** To return to Standby mode, press **Stop/Clear**.

Installing Software

About Samsung Software

You must install the printer software using the supplied CD-ROM after you have set up your machine and connected it to your computer. The CD-ROM provides you with the following software:

Programs for Windows

To use your machine as a printer and scanner in Windows, you must install the MFP driver. You can install selectively or all the following components:

- **Printer driver-** Use this driver to take full advantage of your printer's features.
- **Scanner driver-** TWAIN and Windows Image Acquisition (WIA) driver are available for scanning documents on your machine.
- **Printer Settings Utility-** This program is automatically installed when you install the MFP driver. For information about using the program, see page 2.45.
- **SmarThru-** It is the accompanying Windows-based software for your multifunctional machine. Allows you to edit a scanned image in many ways using a powerful image editor and to send the image by e-mail. You can also open another image editor program installed in your Windows, like Adobe PhotoShop, from SmarThru.

For details, please refer to the onscreen help supplied on the SmarThru program.

- **Set IP-** The Set IP can detect printers in the same network and display the network information.
- **Network Scan driver-** Your machine use the Network Scan program for scanning images. For information about using the program, see page 6.12.

Linux Driver

You can print and scan in Linux using your machine. For information about installing the MFP driver in Linux, see page A.3.

Printer Driver Features

Your printer drivers support the following standard features:

- Paper source selection
- Paper size, orientation and media type
- number of copies

The following table lists a general overview of features supported by your printer drivers.

Feature	PCL 6 Printer Driver	
	Win 98/Me/NT 4.0/2000/XP	Linux
Toner Save	Y	Y
Print quality option	Y	Y
Poster printing	Y	N
Multiple pages per sheet (N-up)	Y	Y(2,4)
Fit to page printing	Y	Y
Scale printing	Y	Y
Different source for first page	Y	Y
Watermark	Y	N
Overlay	Y	N
TrueType fonts option	Y	N

Installing Samsung Software in Windows

System Requirements

Before you begin, ensure that your system meets the minimum requirements.

Item	Requirements		Recommended
Operating system	Windows 98/Me/NT 4.0/2000/XP		
CPU	Windows 98/Me/NT 4.0/2000	Pentium II 400 MHz or higher	Pentium III 933 MHz
	Windows XP	Pentium III 933 MHz or higher	Pentium IV 1 GHz
RAM	Windows 98/Me/NT 4.0/2000	64 MB or higher	128 MB
	Windows XP	128 MB or higher	256 MB
Free disk space	Windows 98/Me/NT 4.0/2000	300 MB or higher	1 GB
	Windows XP	1 GB or higher	5 GB
Internet Explorer	5.0 or higher		5.5



NOTE: For Windows NT 4.0/2000/XP, the system administrator should install the software.

Installing Software for Local Printing

A local printer is a printer directly attached to your computer using the printer cable supplied with your printer, such as a USB or parallel cable. If your printer is attached to a network, skip this step and see “Installing Software for Network Printing” on page 2.34.

You can install the printer software using the typical or custom method.



NOTE: If the “New Hardware Wizard” window appears during the installation procedure, click  in the upper right corner of the box to close the window, or click **Cancel**.

Typical Installation for local printing

This is recommended for most users. All components (Printer Driver, Scanner Driver, Printer Settings Utility and SmarThru) necessary for printer operations will be installed.

- 1 Make sure that the printer is connected to your computer and powered on.
- 2 Insert the supplied CD-ROM into your CD-ROM drive. The CD-ROM should automatically run, and an installation window appears.

If the installation window does not appear, click **Start** and then **Run**. Type **X:\setup.exe**, replacing “X” with the letter which represents your drive and click **OK**.



- 3 Click **Next**.
 - If necessary, select a language from the drop-down list.
 - **View User’s Guide:** Allows you to view the User’s Guide. If your computer doesn’t have Adobe Acrobat, click on this option and it will automatically install Adobe Acrobat Reader for you.

- 4 Select **Typical installation for a local printer**. Click **Next**.

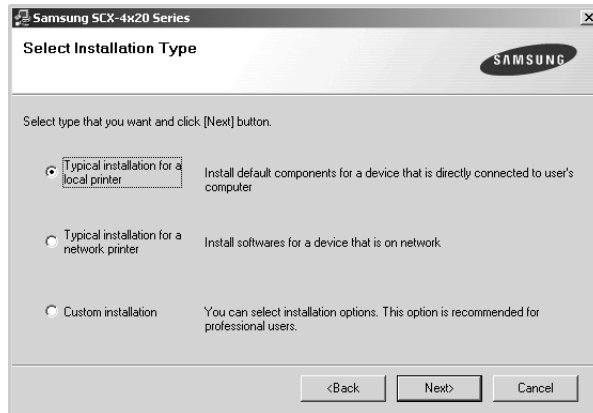

NOTES: If your printer is not already connected to the computer, the following window will appear.

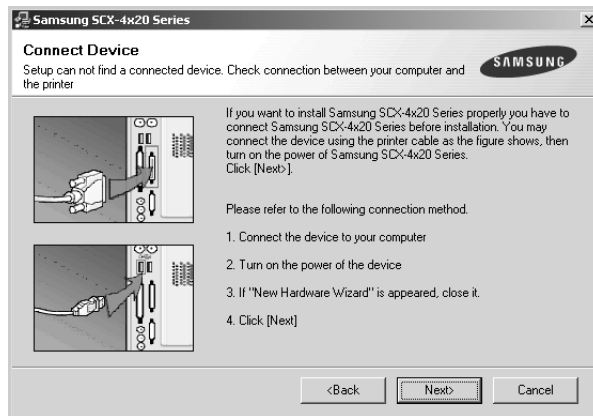

- After connecting the printer, click **Next**.
- If you don't want to connect the printer at this time, click **Next**, and **No** on the following screen. Then the installation will start and a test page will not be printed at the end of the installation.

- 5 After the installation is finished, a window asking you to print a test page appears. If you choose to print a test page, select the checkbox and click **Next**.

Otherwise, just click **Next** and skip to step 7.

- 6 If the test page prints out correctly, click **Yes**. If not, click **No** to reprint it.

- 7 To register yourself as a user of Samsung Printers in order to receive information from Samsung, select the checkbox and click **Finish**. You are now sent to the Samsung web site.

Otherwise, just click **Finish**.

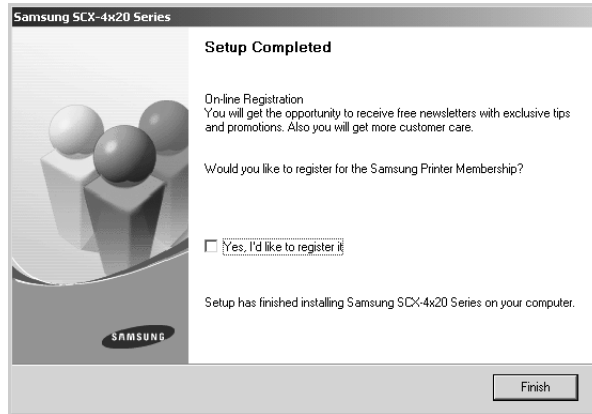

NOTE: After setup is complete, if your printer driver doesn't work properly, reinstall the printer driver. See "Repairing Software" on page 2.41.

Custom Installation for local printing

You can choose individual components to install.

- 1 Make sure that the printer is connected to your computer and powered on.
- 2 Insert the supplied CD-ROM into your CD-ROM drive.

The CD-ROM should automatically run, and an installation window appears.

If the installation window does not appear, click **Start** and then **Run**. Type **X:\setup.exe**, replacing "X" with the letter which represents your drive and click **OK**.

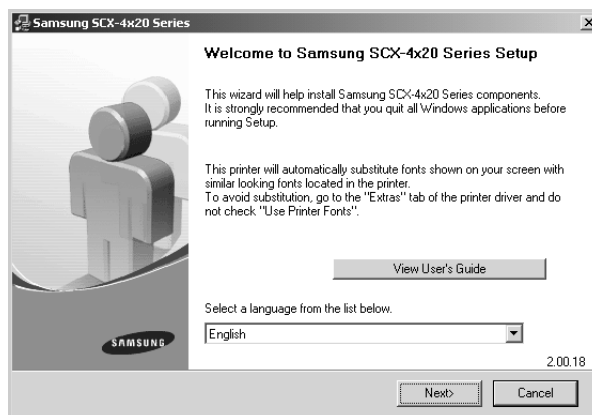

- 3 Click **Next**.
 - If necessary, select a language from the drop-down list.

- **View User's Guide:** Allows you to view the User's Guide. If your computer doesn't have Adobe Acrobat, click on this option and it will automatically install Adobe Acrobat Reader for you.

4 Select **Custom installation**. Click **Next**.

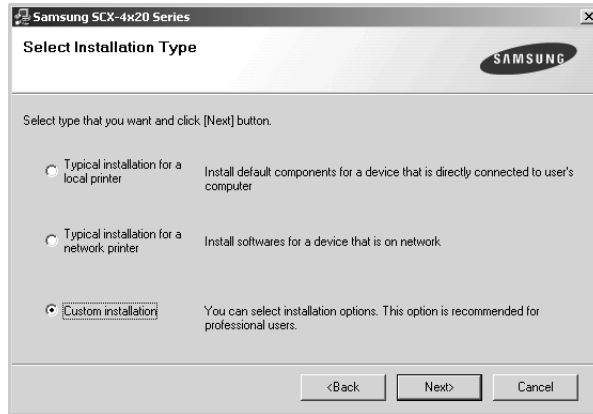

5 Select your local printer and click **Next**.

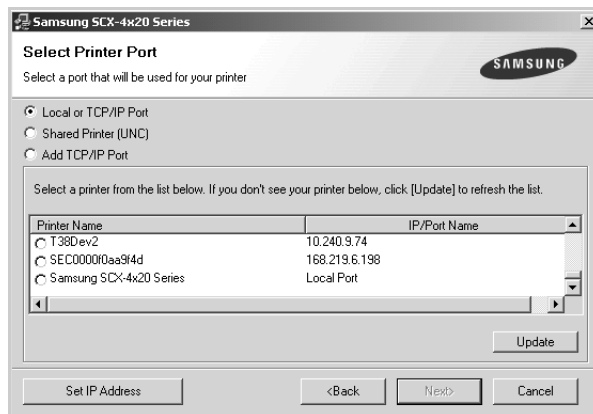



NOTES: If your printer is not already connected to the computer, the following window will appear.

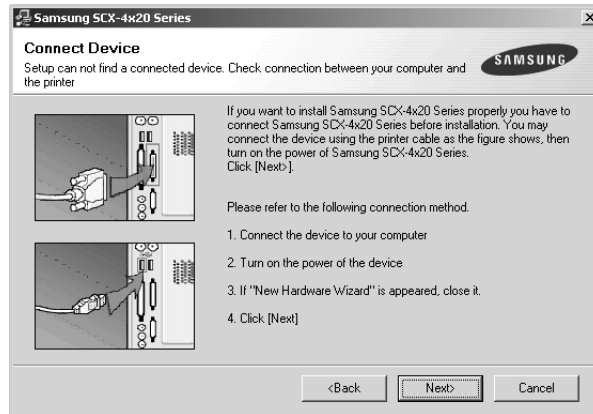

2

- After connecting the printer, click **Next**.
- If you don't want to connect the printer at this time, click **Next**, and **No** on the following screen. Then the installation will start and a test page will not be printed at the end of the installation.

6 Select the components to be installed and click **Next**.

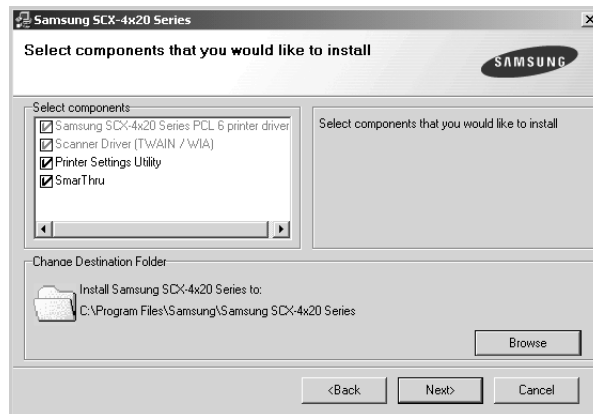

7 After the installation is finished, a window asking you to print a test page appears. If you choose to print a test page, select the checkbox and click **Next**.

Otherwise, just click **Next** and skip to step 9.

8 If the test page prints out correctly, click **Yes**.

If not, click **No** to reprint it.

- 9 To register yourself as a user of Samsung Printers in order to receive information from Samsung, select the checkbox and click **Finish**. You are now sent to the Samsung web site.

Otherwise, just click **Finish**.

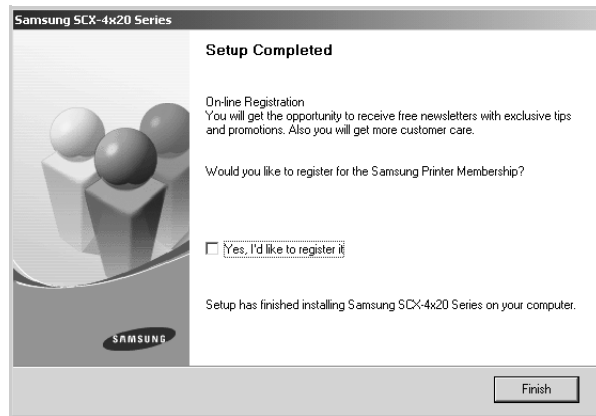

Installing Software for Network Printing

When you connect your printer to a network, you must first configure the TCP/IP settings for the printer. After you have assigned and verified the TCP/IP settings, you are ready to install the software on each computer on the network.

You can install the printer software using the typical or custom method.

Typical Installation for Network Printing

This is recommended for most users. All components (Printer Driver, Scanner Driver, SmarThru, Network Scan and Set IP) necessary for printer operations will be installed.

This is recommended for most users. All components necessary for printer operations will be installed.

- 1 Make sure that the printer is connected to your network and powered on. For details about connecting to the network, see page 2.13
- 2 Insert the supplied CD-ROM into your CD-ROM drive.
The CD-ROM should automatically run, and an installation window appears.

If the installation window does not appear, click **Start** and then **Run**. Type **X:\setup.exe**, replacing “X” with the letter which represents your drive and click **OK**.



3 Click **Next**.

- If necessary, select a language from the drop-down list.
- **View User's Guide:** Allows you to view the User's Guide. If your computer doesn't have Adobe Acrobat, click on this option and it will automatically install Adobe Acrobat Reader for you.

4 Select **Typical installation for a network printer**. Click **Next**.

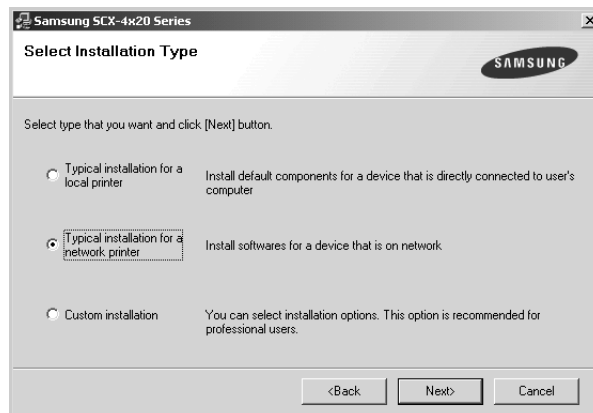

- 5 The list of printers available on the network appears. Select the printer you want to install from the list and then click **Next**.

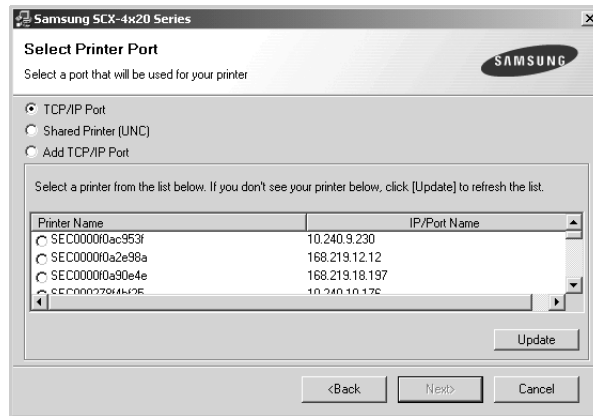

- If you do not see your printer on the list, click **Update** to refresh the list, or select **Add TCP/IP Port** to add your printer to the network. To add the printer to the network, enter the port name and the IP address for the printer.
- To find a shared network printer (UNC Path), select **Shared Printer [UNC]** and enter the shared name manually or find a shared printer by clicking the **Browse** button.

- 6 After the installation is finished, a window appears asking you to print a test page and to register yourself as a user of Samsung Printers in order to receive information from Samsung. If you so desire, select the corresponding checkbox(es) and click **Finish**.

Otherwise, just click **Finish**.

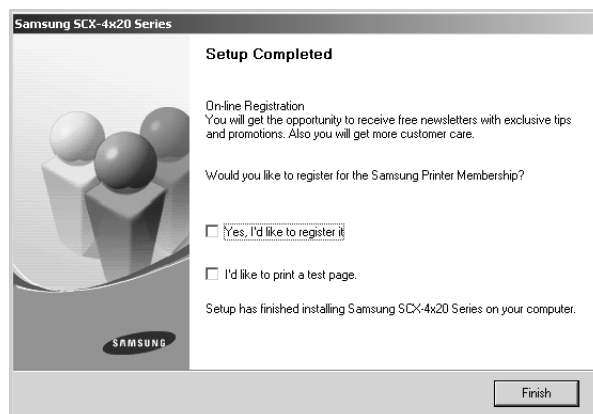

NOTE: After setup is complete, if your printer driver doesn't work properly, reinstall the printer driver. See "Repairing Software" on page 2.41.

Custom Installation for Network Printing

You can choose individual components to install and set a specific IP address.

- 1 Make sure that the printer is connected to your network and powered on. For details about connecting to the network, see page 2.13.

- 2 Insert the supplied CD-ROM into your CD-ROM drive.

The CD-ROM should automatically run, and an installation window appears.

If the installation window does not appear, click **Start** and then **Run**. Type **X:\setup.exe**, replacing "X" with the letter which represents your drive and click **OK**.



- 3 Click **Next**.

- If necessary, select a language from the drop-down list.
- **View User's Guide:** Allows you to view the User's Guide. If your computer doesn't have Adobe Acrobat, click on this option and it will automatically install Adobe Acrobat Reader for you.

4 Select **Custom installation**. Click **Next**.

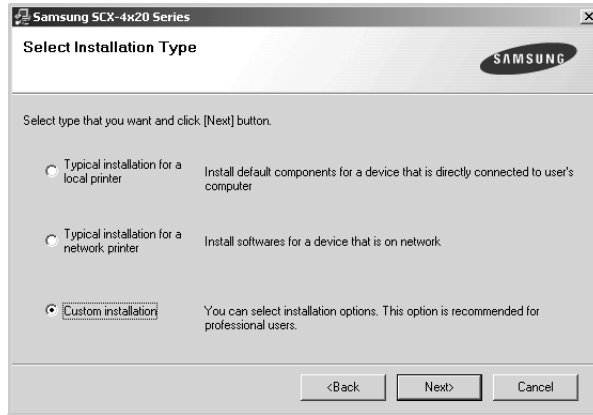

5 The list of printers available on the network appears. Select the printer you want to install from the list and then click **Next**.

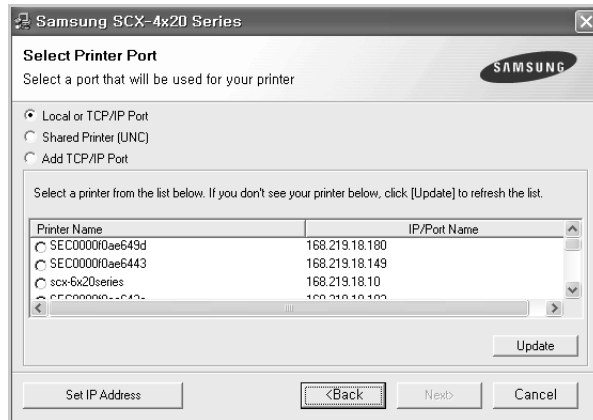

- If you do not see your printer on the list, click **Update** to refresh the list, or select **Add TCP/IP Port** to add your printer to the network. To add the printer to the network, enter the port name and the IP address for the printer.
- To find a shared network printer (UNC Path), select **Shared Printer [UNC]** and enter the shared name manually or find a shared printer by clicking the **Browse** button.



NOTES: If you want to set a specific IP address on a specific network printer, click the **Set IP Address** button. The Set IP Address window appears. Do as follows:

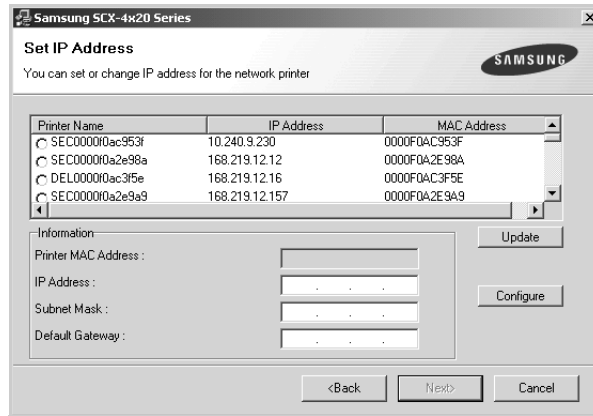

- Select a printer to be set with a specific IP address from the list.
- Configure an IP address, subnet mask, and gateway for the printer manually and click **Configure** to set the specific IP address for the network printer.
- When your computer asks you to confirm your selection, click **Yes**.

6 Select the components to be installed and click **Next**.

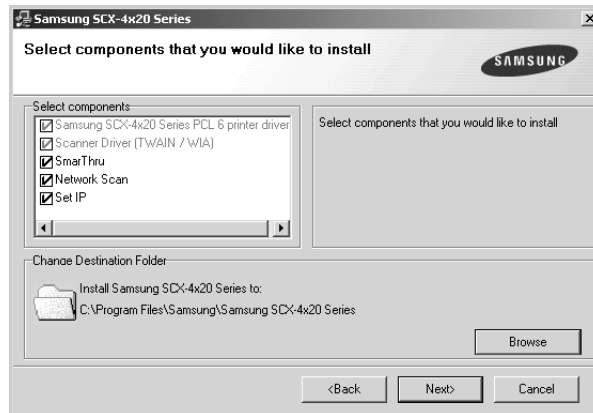

- 7 After selecting the components, the following window appears. You can also change the printer name, set the printer to be shared on the network, set the printer as the default printer, and change the port name of each printer. Click **Next**.

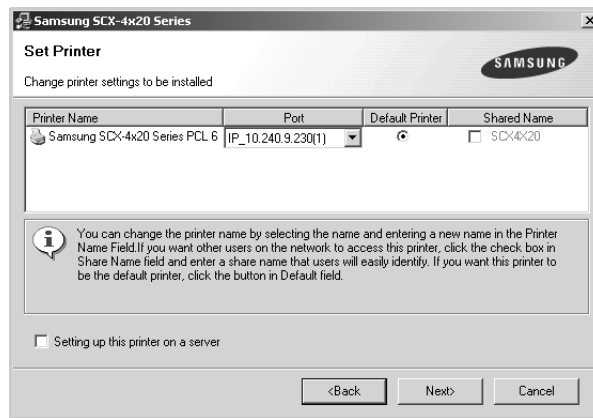

To install this software on a server, select the **Setting up this printer on a server** checkbox.

- 8 After the installation is finished, a window appears asking you to print a test page and to register yourself as a user of Samsung Printers in order to receive information from Samsung. If you so desire, select the corresponding checkbox(es) and click **Finish**.

Otherwise, just click **Finish**.

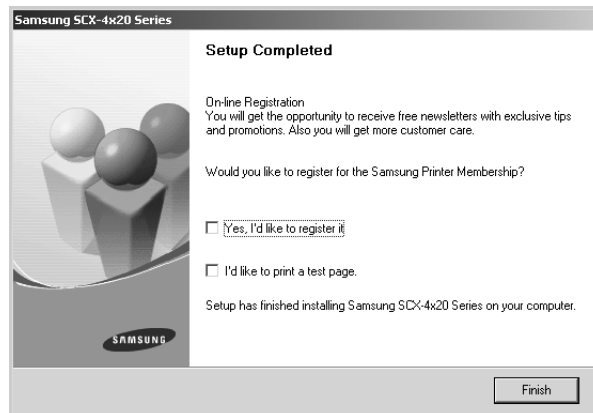

NOTE: After setup is complete, if your printer driver doesn't work properly, reinstall the printer driver. See "Repairing Software" on page 2.41.

Repairing Software

Repair is required if your installation fails or the software does not work properly. This Repair procedure does not physically repair SmarThru and Network Scan software.

2

- 1 Start Windows.
- 2 From the **Start** menu select **Programs** or **All Programs** → **Samsung SCX-4x20 Series** → **Maintenance**.
- 3 Select **Repair** and click **Next**.
- 4 The list of printers available on the network appears. Select the printer you want to reinstall from the list and then click **Next**.

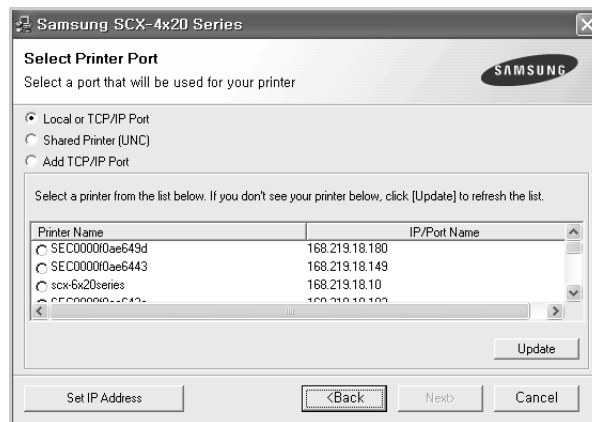

- If you do not see your printer on the list, click **Update** to refresh the list, or select **Add TCP/IP Port** to add your printer to the network. To add the printer to the network, enter the port name and the IP address for the printer.
- To find a shared network printer (UNC Path), select **Shared Printer [UNC]** and enter the shared name manually or find a shared printer by clicking the **Browse** button.

You will see a component list so that you can reinstall any item individually.



NOTES: If your printer is not already connected to the computer, the following window will appear.

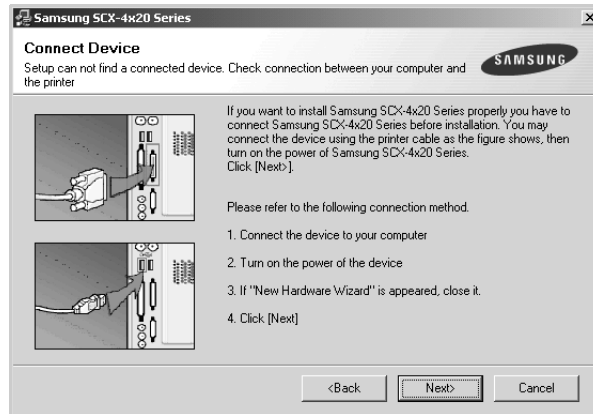

- After connecting the printer, click **Next**.
- If you don't want to connect the printer at this time, click **Next**, and **No** on the following screen. Then the installation will start and a test page will not be printed at the end of the installation.

5 Select the components you want to reinstall and click **Next**.

If you select **Samsung SCX-4x20 Series PCL 6 printer driver**, the window asking you to print a test page appears. Do as follows:

- a. To print a test page, select the check box and click **Next**.
- b. If the test page prints out correctly, click **Yes**.
If it doesn't, click **No** to reprint it.

6 When the reinstallation is done, click **Finish**.

Removing Software

Uninstall is required if you are upgrading the software or if your installation fails.

Uninstalling the MFP Driver

- 1 Start Windows.
- 2 From the **Start** menu select **Programs** or **All Programs** → **Samsung SCX-4x20 Series** → **Maintenance**.
- 3 Select **Remove** and then click **Next**.
Then you will see a component list so that you can remove any of them individually.

If you want to uninstall the printer driver, check **Samsung SCX-4x20 Series PCL 6 printer driver**.

If you want to uninstall the Scanner driver, select **Scanner Driver (TWAIN/WIA)**.

If you want to uninstall the Printer Settings Utility, check **Printer Settings Utility**.

If you want to uninstall the Set IP, check **Set IP**.
- 4 Select the components you want to remove and then click **Next**.
- 5 When your computer asks you to confirm your selection, click **Yes**.

The selected driver and all of its components are removed from your computer.
- 6 After the software is removed, click **Finish**.

Uninstalling the SmarThru



NOTE: Before beginning uninstallation, ensure that all applications are closed on your computer. A system reboot is required after the software is uninstalled.

- 1 From the **Start** menu, select **Programs**.
- 2 Select **SmarThru 4**, and then select **Uninstall SmarThru 4**.
- 3 When your computer asks you to confirm, click **OK**.
- 4 Click **Finish**.

You may be prompted to restart your computer. In this case you must shut the computer down and then restart it before the changes will be saved.

Uninstalling the Network Scan Driver

- 1 Start Windows.
- 2 From the **Start** menu select **Programs** or **All Programs** → **Samsung Network Printer Utilities** → **Network Scan** → **Uninstall Network Scan**.
- 3 When your computer asks you to confirm, click **OK**.
- 4 Click **Finish**.

Using the Printer Settings Utility

Using Printer Settings Utility, you can create and edit Phonebook entries from your computer and set up print and scan system data options. You can also configure the destination launches when you use the **Scan-to** button on the control panel, and update the firmware of the machine.

When you install the Samsung software, the Printer Settings Utility program is automatically installed.

For information about installing the Samsung software, see page 2.29.

To open the Printer Settings Utility:

- 1 Start your Windows.
- 2 Click the **Start** button on your desktop computer.
- 3 From **Programs**, select **Samsung SCX-4x20 Series** and then **Printer Settings Utility**.

The Printer Settings Utility window opens.

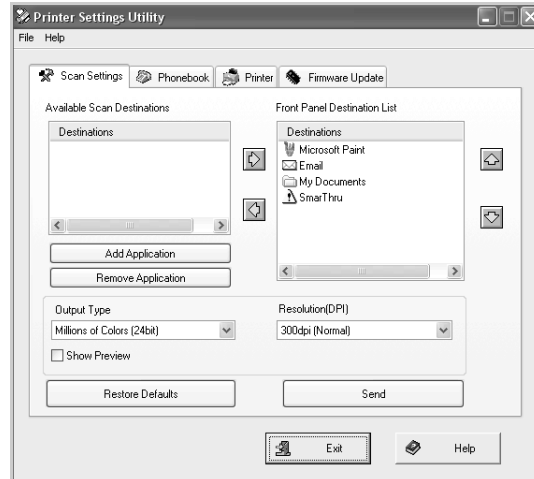

- 4 The Printer Settings Utility window provides the following tabs: **Scan Settings**, **Phonebook**, **Printer**, and **Firmware Update**.

To exit, click the **Exit** button at the bottom of each tab.

For further details, click the **Help** button at the bottom of each tab.

The Scan Settings Tab

Click the **Scan Settings** tab to configure the scan destination list that appears on the control panel display when you press **Scan-to** on the control panel. Using the destination list, you can select a software program that an image can be scanned to.

You can also configure the scan settings, such as the output type and resolution.

Select the program you want from the Available Scan Destinations and click to add it to the Front Panel Destination List. To delete the selected program, click .

Click to restore the default settings.

Downloads the settings made in the Printer Settings Utility to your machine.

The Phonebook Tab

Click the **Phonebook** tab to create and edit Phonebook entries.

Reads the Phonebook entries from the machine to the Printer Settings Utility.

Downloads the Phonebook entries from the Printer Settings Utility to the machine.

Phonebook entries

Allows you to edit a selected Phonebook entry in a separate Edit window.

Deletes a selected Phonebook entry.

Deletes all Phonebook entries.

Allows you to set up group dial numbers. See page 2.47.

When you click **Group dial**, the following window opens.

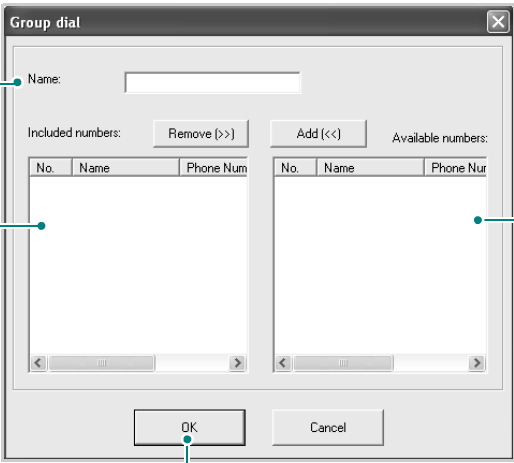

Enter a name for the group.

Shows the numbers included in the group. To remove a number, select it and click **Remove**.

Shows the Phonebook entries you can include in the group. After selecting a number, click **Add** to move it to the Included numbers list.

Click to save the group dial number after adding or removing numbers for the group.

The **Group dial** dialog box features a "Name:" text field at the top. Below it are two lists: "Included numbers:" and "Available numbers:". Each list has columns for "No.", "Name", and "Phone Num". Between the lists are "Remove (>>)" and "Add (<<)" buttons. At the bottom are "OK" and "Cancel" buttons.

The Printer Tab

Click the **Printer** tab to configure print system settings.

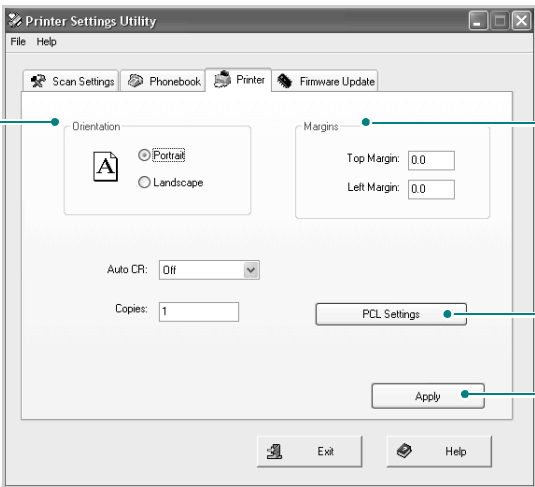

Allows you to select the default orientation of print image on the page.

Allows you to set the margin of print materials.

Allows you to set the PCL emulation configuration.

Downloads the settings made in the Printer Settings Utility to your machine.

The **Printer Settings Utility** window has a menu bar with "File" and "Help". Below is a tabbed interface with "Scan Settings", "Phonebook", "Printer", and "Firmware Update". The "Printer" tab is active, showing "Orientation" (Portrait/Landscape), "Margins" (Top/Left), "Auto CR:" (Off), "Copies:" (1), "PCL Settings:" (a button), and an "Apply" button. At the bottom are "Exit" and "Help" buttons.

The Firmware Update Tab

Click the **Firmware Update** tab to update the firmware of your machine. This feature should be used by an authorized technician. Please consult with the purchase point.

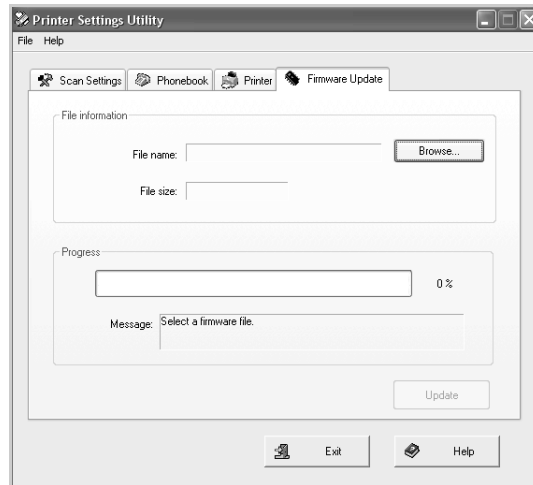

3

PAPER HANDLING

This chapter introduces you to the basics of selecting print materials and loading them into your machine.

This chapter includes:

- **Selecting Print Materials**
- **Loading Paper**
- **Selecting an Output Location**

Selecting Print Materials

You can print on a variety of print materials, such as plain paper, envelopes, labels, transparencies, and etc.. Always use print materials that meet the guidelines for use with this machine. See "Paper Specifications" on page D.6. To get the best possible print quality, use only high-quality copier-grade paper.

When you choose print materials, consider the following:

- **Desired outcome:** The paper you choose should be appropriate for your project.
- **Size:** You can use any size paper that fits easily within the paper adjusters of the paper tray.
- **Weight:** Your machine supports paper weights as follows:
 - 16 ~ 24 lb (60 ~ 90 g/m²) bond for the standard paper tray (Tray 1) and optional paper tray (Tray 2)
 - 16 ~ 43 lb (60 ~ 163 g/m²) bond for the Multipurpose tray
- **Brightness:** Some papers are whiter than others and produce sharper, more vibrant images.
- **Surface smoothness:** The smoothness of the paper affects how crisp the printing looks on the paper.



CAUTION: Using print materials that does not conform to the specifications listed on page D.9 may cause problems that may require service. This service is not covered by the warranty or service agreements.

Paper Type, Input Sources, and Capacities

Paper Type	Input Source/Capacity*		
	Tray 1	Optional Tray 2	Multipurpose tray
Plain paper	250	250	50
Envelopes	-	-	5
Labels**	-	-	5
Transparencies**	-	-	5
Card stock**	-	-	5

* Maximum capacity may differ depending on media weight, thickness, and environmental conditions.

**If you experience excessive jamming, load one sheet at a time through the Multipurpose tray.

Guidelines for Paper and Special Materials

When selecting or loading paper, envelopes, or other special material, keep these guidelines in mind:

- Always use paper and other materials that conform with the specifications listed under “Paper Specifications” on page D.6.
- Attempting to print on damp, curled, wrinkled, or torn paper can cause paper jams and poor print quality.
- Use only high quality copier grade paper for the best print quality.
- Avoid paper with embossed lettering, perforations, or a texture that is too smooth or too rough. Paper jams may occur.
- Store paper in its ream wrapper until you are ready to use. Place cartons on pallets or shelves, not on the floor. Do not place heavy objects on top of the paper, whether it is packaged or unpackaged. Keep it away from moisture, or other conditions that can cause it to wrinkle or curl.
- Store unused materials at temperatures between 15 °C and 30 °C (59 °F to 86 °F). The relative humidity should be between 10 % and 70 %.
- During storage, you should use a moisture-proof wrap, such as a plastic container or bag, to prevent dust and moisture from contaminating your paper.
- Load special paper types one sheet at a time through the Multipurpose tray to avoid paper jams.
- Only use materials specifically recommended for use in laser printers.
- To prevent special materials, such as transparencies and label sheets from sticking together, remove them as they print out.
- For envelopes:
 - Use only well-constructed envelopes with sharp and well creased folds.
 - Do not use envelopes with clasps and snaps.
 - Do not use envelopes with windows, coated lining, self-adhesive seals, or other synthetic materials.
 - Do not use damaged or poorly made envelopes.
- For transparencies:
 - Place them on a flat surface after removing them from the machine.

- Do not leave them in the paper tray for long periods of time. Dust and dirt may accumulate on them, resulting in spotty printing.
- To avoid smudging caused by fingerprints, handle them carefully.
- To avoid fading, do not expose printed transparencies to prolonged sunlight.
- For labels:
 - Verify that their adhesive material can tolerate a fusing temperature of 200 °C (392 °F) for 0.1 second.
 - Make sure that there is no exposed adhesive material between them. Exposed areas can cause labels to peel off during printing, which can cause paper jams. Exposed adhesive can also cause damage to machine components.
 - Do not load a sheet of them through the machine more than once. The adhesive backing is designed for one pass through the machine.
 - Do not use labels that are separating from the backing sheet or are wrinkled, bubbled or otherwise damaged.
- Do not use **Carbonless** paper and **Tracing** paper. Use of these types of paper could result in chemical smells and could damage your machine.

Loading Paper

In the Standard Tray

Load the print material you use for the majority of your print jobs in the standard tray.

The standard tray can hold a maximum of 250 sheets of 20 lb plain paper.

You can purchase an optional paper tray (Tray 2) and attach it below the standard tray to load an additional 250 sheets of paper. See page C.5 for more information about installing the optional Tray 2.

The paper level indicator on the front of the paper tray shows the amount of paper currently left in the tray. When the tray is empty, the indicator of the bar is completely lowered.

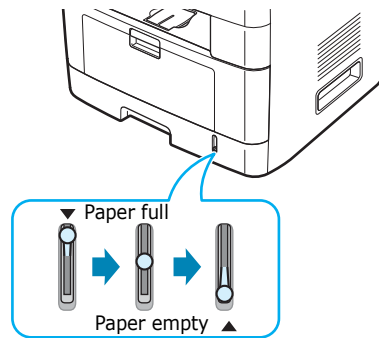

To load paper, pull open the paper tray and load paper with the side to be printed on face down.

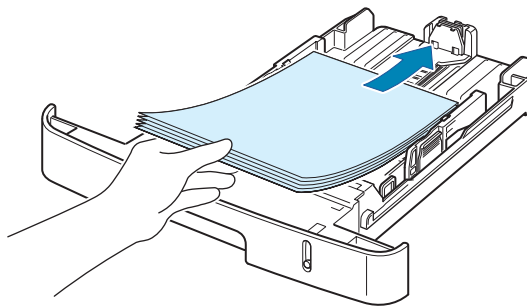

You can load letterhead paper with the design side face down. The top edge of the sheet with the logo should be placed at the front of the tray.

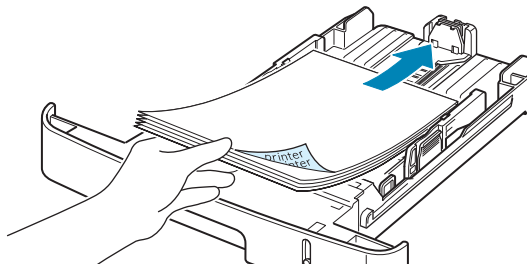

For details about loading paper in the paper tray, see “Loading Paper” on page 2.7.



NOTES:

- If you experience problems with paper feed, place one sheet at a time in the Multipurpose tray.
- You can load up to 150 sheets of previously printed paper. The printed side should be facing up with an uncurled edge at the front. If you experience problems with paper feed, turn the paper around. Note that the print quality is not guaranteed.

In the Multipurpose Tray

The Multipurpose tray can hold several sizes and types of print material, such as transparencies, postcards, note cards, and envelopes. It is useful for single page printing on letterhead or colored paper. You can load approximately 50 sheets of plain paper, 5 envelopes, 5 transparencies, 5 sheets of card stock, or 5 labels at a time.

To load print material in the Multipurpose tray:

- 1 Lower the Multipurpose tray and unfold the paper support extension, as shown.



- 2 If you are using paper, flex or fan the edge of the paper stack to separate the pages before loading.

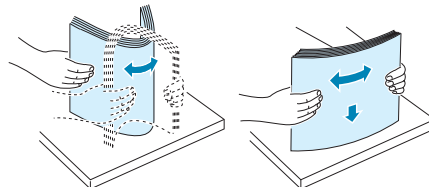

For transparencies, hold them by the edges and avoid touching the print side. Oils from your fingers can cause print quality problems.

- 3 Load the print material **with the side to be printed on facing up.**

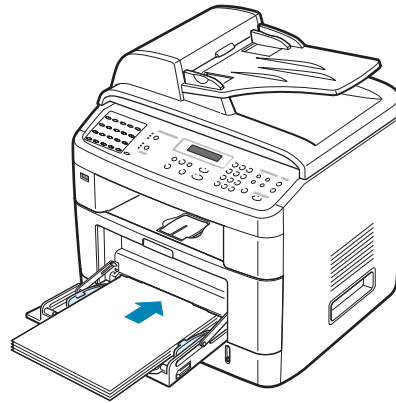

For envelopes, load them with the flap side down and with the stamp area on the top left side.



NOTES:

- If envelopes jam while printing, try reducing the number of envelopes in the Multipurpose tray.
 - If you want to print on previously printed paper from the Multipurpose tray, the printed side should be facing down with an uncurled edge toward the machine. If you experience problems with the paper feeding, turn the paper around.
-

- 4 Squeeze the width guide and adjust it to the width of the print material without bending it.

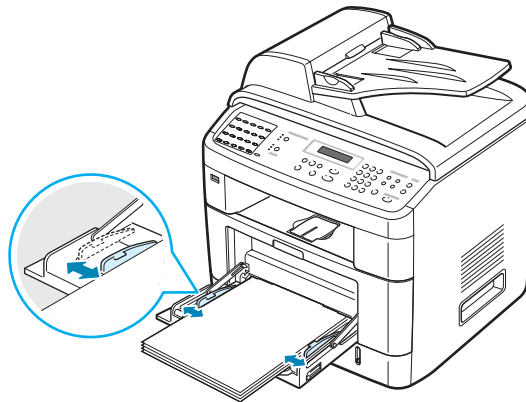

- 5 After loading paper, you need to set the paper type and size for the Multipurpose tray. See page 2.20 for copying and faxing or page 4.6 for PC-printing.



NOTE: The settings made from the printer driver override the settings on the control panel.

- 6 If you want the machine to stack the printed pages on the rear output slot, open the rear door to use the rear output slot.



CAUTION: Make sure to open the rear output slot when you print on transparencies. If not, they may tear while exiting the machine.

- 7 After printing, fold away the paper support extension and close the Multipurpose tray.

Using the Manual Feed Mode

You can manually load a sheet of print material in the Multipurpose tray if you select **Manual Feed** in the **Source** option from the **Paper** tab when you change print settings to print a document. For details about changing print settings, see page 4.6. Manually loading paper can be helpful when you want to check the print quality after each page is printed.

This loading procedure is almost the same as the procedure for loading in the Multipurpose tray.

- 1 Lower the Multipurpose tray and unfold the paper support extension.
- 2 Load a sheet of print material **with the side to be printed on facing up**.



- 3 Squeeze the width guide and adjust it to the width of the print material without bending it.

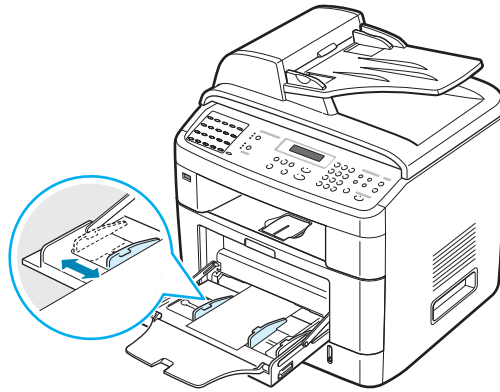

3

- 4 If you want the machine to stack the printed pages on the rear output slot, open the rear door to use the rear output slot.



CAUTION: Make sure to open the rear output slot when you print on transparencies. If not, they may tear while exiting the machine.

- 5 After printing, fold away the paper support extension and close the Multipurpose tray.

Tips on Using the Multipurpose Tray

- Load only one size of print material at a time in the Multipurpose tray.
- To prevent paper jams, do not add paper when there is still paper in the Multipurpose tray. This also applies to other types of print materials.
- Print materials should be loaded face up with the top edge going into the Multipurpose tray first and be placed in the center of the tray.
- Always load only the print materials specified in the Specifications on page D.6 to avoid paper jams and print quality problems.
- Flatten any curl on postcards, envelopes, and labels before loading them into the Multipurpose tray.
- When you print on 76 mm x 127 mm (3 x 5 in.) sized media on the Multipurpose tray, open the rear door to use the rear output slot.
- Make sure to open the rear door when you print on transparencies. If not, they may tear while exiting the machine.
- If you experience jams with card stock feeding, turn the paper around the tray again.

Selecting an Output Location

The machine has two output locations: the rear output slot (face up) and the front output tray (face down).

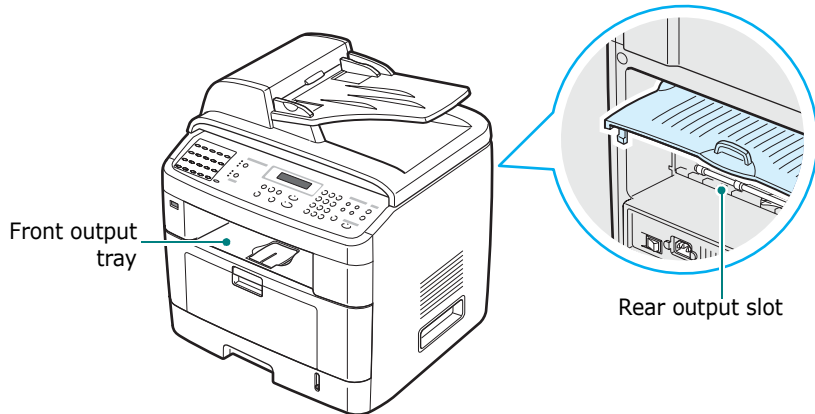

To use the front output tray, make sure that the rear door is closed. To use the rear output slot, open the rear door.



NOTES:

- If paper coming out of the front output tray has problems, such as excessive curl, try printing to the rear output slot.
 - To avoid paper jams, do not open or close the rear door while the machine is printing.
-

Printing to the Front Output Tray *(Face down)*

The front output tray collects printed paper face down, in the order in which the sheets were printed. The tray should be used for most print jobs.



Printing to the Rear Output Slot *(Face up)*

Using the rear output slot, paper comes out of the machine face up.

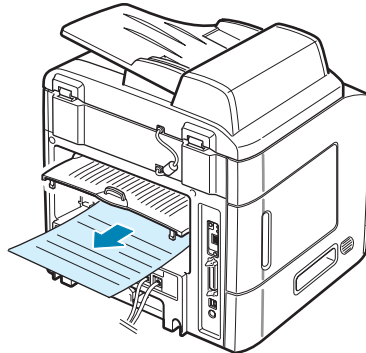

3

Printing from the Multipurpose tray to the rear output slot provides a **straight paper path**. Using the rear output slot might improve the output quality with the following:

- envelopes
- labels
- small custom-sized paper
- postcards
- transparencies

To use the rear output slot:

- 1 Open the rear door by pulling it upward.

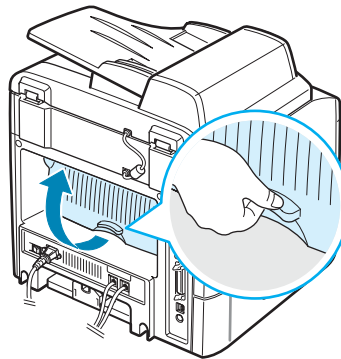

CAUTION: The fuser area inside the rear door of your machine becomes very hot when in use. Take care not to burn your fingers when you access this area.

- 2 If you do not want to stack the printed pages on the rear output slot, close the rear door. The pages stack on the front output tray.

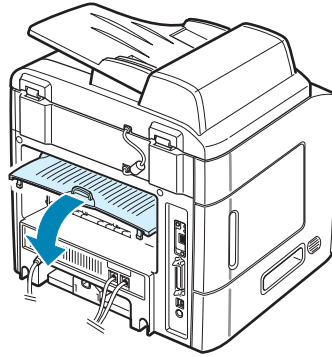

4

PRINTING TASKS

This chapter explains how to print your documents in Windows and how to use the print settings.

This chapter includes:

- **Printing a Document in Windows**
- **Printer Settings**
- **Printing Multiple Pages on One Sheet of Paper**
- **Printing Posters**
- **Fitting Your Document to a Selected Paper Size**
- **Printing a Reduced or Enlarged Document**
- **Using Watermarks**
- **Using Overlays**

Printing a Document in Windows

The following procedure describes the general steps required for printing from various Windows applications. The exact steps for printing a document may vary depending on the application program you are using. Refer to the User's Guide of your software application for the exact printing procedure.



NOTE: For detailed information about printing from a Linux system, see Appendix A.

- 1 Open the document you want to print.
- 2 Select **Print** from the **File** menu. The Print window opens. It may look slightly different depending on your application.

You can select the basic print settings within the Print window. These settings include the number of copies and the print range.

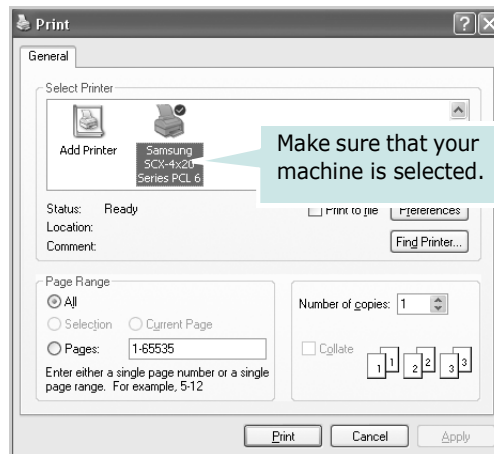

▲ Windows XP

- 3 To take advantage of the printer features provided by your machine, click **Properties** or **Preferences** in the application's Print window. Go to step 4.

If you see a **Setup, Printer,** or **Options** button in your Print window, click it instead. Then click **Properties** on the next screen.

- 4 Click **OK** to close the printer properties window.
- 5 To start the print job, click **OK** or **Print** in the Print window.

Canceling a Print Job

There are two ways to cancel a print job:

To stop a print job from the control panel:

Press the **Stop/Clear** button.

Your machine finishes printing the page that is moving through the machine and deletes the rest of the print job. Pressing the button cancels only the current job. If more than one print job is in the machine's memory, you need to press the button once for each job.



To stop a print job from the Printers folder:

If the print job is waiting in a print queue or print spooler, such as the Printer group in Windows, delete the job as follows:

- 1 Click the Windows **Start** menu.
- 2 For Windows 98/NT4.0/2000/Me, select **Settings** and then **Printers**.
For Windows XP, select **Printers and Faxes**.
- 3 Double-click the **Samsung SCX-4x20 Series PCL 6** icon.
- 4 From the **Document** menu:
For Windows 98/Me, select **Cancel Printing**.
For Windows NT4.0/2000/XP, select **Cancel**.



NOTE: You can access this window simply by double-clicking the machine icon at the bottom right corner of the Windows desktop.

Printer Settings

You can use the Samsung SCX-4x20 Series printer properties window, which allows you to access all of the printer options you need when using your machine. When the printer properties are displayed, you can review and change whatever settings are needed for your print job.

The printer's properties window may differ, depending on your operating system. This User's Guide shows the Printing Preferences window for Windows XP.

Your printer's Printing Preferences window consists of 5 tabs: **Layout, Paper, Graphics, Extras, and About.**

If you access printer properties through the **Printers** folder, you can view additional Windows-based tabs (refer to your Windows User's Guide) and the **Printer** tab (see page 4.11).



NOTES:

- Most Windows applications will override the settings you specify in the printer driver. Change all of the print settings available in the software application first, and change any remaining settings using the printer driver.
 - The settings you change remain in effect only while you are using the current program. To make your changes permanent, make them in the **Printers** folder. Follow this procedure:
 1. Click the Windows **Start** menu.
 2. For Windows 98/Me/NT 4.0/2000, select **Settings** and then **Printers**.
For Windows XP, select **Printers and Faxes**.
 3. Select the **Samsung SCX-4x20 Series PCL 6** machine icon.
 4. Click the right mouse button on the printer icon and:
 - In Windows 98/Me, select **Properties**.
 - In Windows 2000/XP, select **Printing Preferences**.
 - In Windows NT 4.0, select **Document Default**.
 5. Change the settings on each tab, and click **OK**.
-

Layout tab

The **Layout** tab provides options to adjust how the document appears on the printed page. The **Layout Options** includes **Multiple Pages per Side** and **Poster**. See page 4.2 for more information on accessing printer properties.

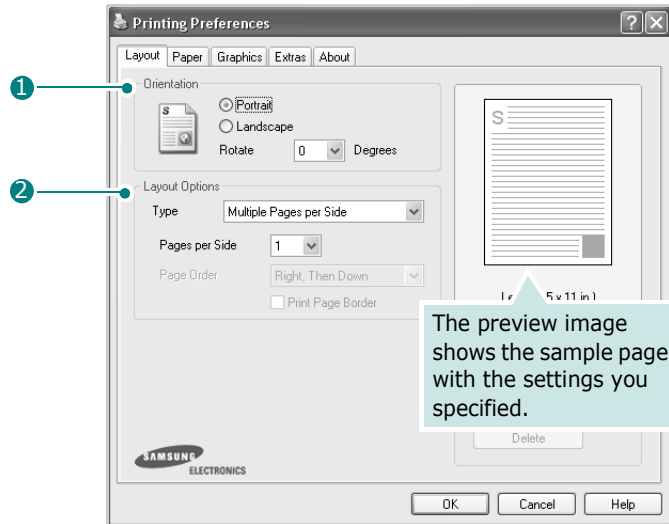

4

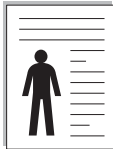
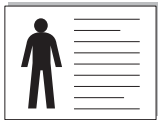
Property	Description
<p>1 Orientation</p>	<p>Orientation allows you to select the direction in which information is printed on a page.</p> <ul style="list-style-type: none"> • Portrait prints across the width of the page, letter style. • Landscape prints across the length of the page, spreadsheet style. <p>If you want to turn the page upside down, select Rotate 180 Degrees.</p> <div style="display: flex; justify-content: space-around; align-items: center;"> <div style="text-align: center;">  <p>▲ portrait</p> </div> <div style="text-align: center;">  <p>▲ Landscape</p> </div> </div>
<p>2 Layout Options</p>	<p>Layout Options allows you to select advanced printing options. For details, see page 4.13~4.14.</p>

Paper Tab

Use the following options for paper handling. See page 4.2 for more information about accessing printer properties.

Click the **Paper** tab to access many paper properties.

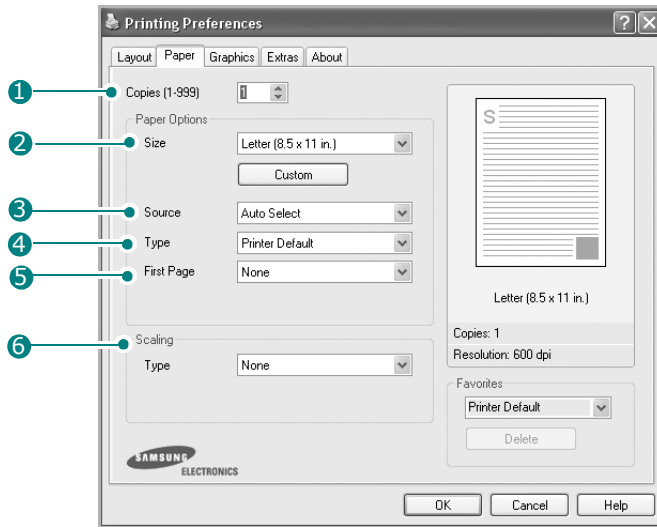

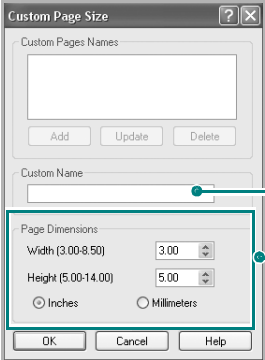
Property	Description
<p>1 Copies</p>	<p>Copies allows you to choose the number of copies to be printed. You can enter up to 999.</p>
<p>2 Size</p>	<p>Size allows you to choose the size of the paper loaded in the tray. If the required size is not listed in the Size box, click Custom. When the Custom Page Size window appears, set the size and click OK. The setting appears on the list so that you can select it.</p>  <p>Enter the custom name you want to use.</p> <p>Enter the paper size.</p>

Property	Description
<p>3 Source</p>	<p>Make sure that Source is set to the appropriate paper tray.</p> <p>Use the Manual Feed source when printing to special material. You need to load one sheet at a time into the Multipurpose tray. See page 3.8.</p> <p>If you install an optional Tray 2 and set the Tray 2 in printer properties (see page C.7), you can select Tray2.</p> <p>If the paper source is set to Auto Select, the machine automatically picks up print material in the following order: the Multipurpose tray, Tray 1, and optional Tray 2.</p>
<p>4 Type</p>	<p>Make sure that Type is set to Printer Default. If you load a different type of print material, select the corresponding paper type. For more information about print materials, see Chapter 3, Paper Handling.</p> <p>If you use cotton paper, set the paper type to Thick for the best printing.</p> <p>To use recycled paper, which weighs from 75g/m² to 90g/m² (20lb to 24lb), or colored paper, select Color Paper.</p>
<p>5 First Page</p>	<p>This property allows you to print the first page using a different paper type from the rest of the document. You can select the paper source for the first page.</p> <p>For example, load thick stock for the first page into the Multipurpose tray, and plain paper into Tray1. Then, select Tray1 in the Source option and Multi-Purpose Tray in the First Page option.</p>
<p>6 Scaling</p>	<p>Scaling allows you to automatically or manually scale your print job on a page. You can choose from None, Fit to Page, and Reduce/Enlarge. For details, see page 4.16~4.17.</p>

Graphic Tab

Use the following options to adjust the print quality for your specific printing needs. See page 4.2 for more information about accessing printer properties.

Click the **Graphics** tab to display the properties shown below.

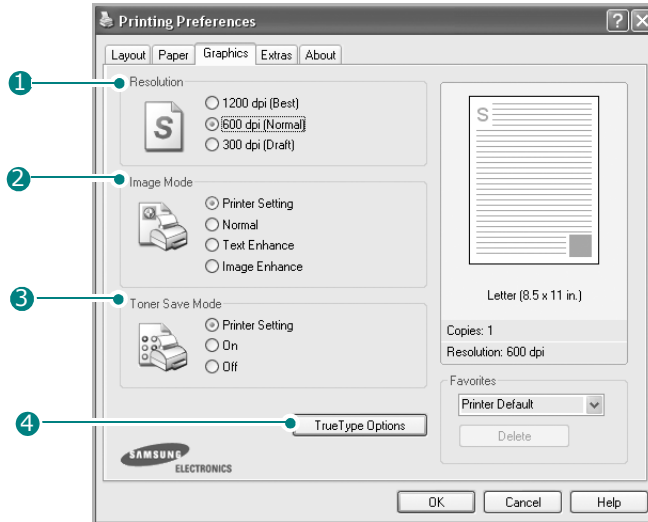

Property	Description
<p>1 Resolution</p>	<p>You can select the printing resolution by choosing from 1200 dpi [Best], 600 dpi [Normal], or 300 dpi [Draft]. The higher the setting, the sharper the printed characters and graphics. Higher settings may increase the time it takes to print a document.</p>
<p>2 Image Mode</p>	<p>Some printed characters or images appear to have jagged or uneven edges. Set this Image Mode option to improve the print quality of your text and image, and make the characters and images appear smoother.</p> <ul style="list-style-type: none"> • Printer Setting: When you select this option, this feature is determined by the setting you've made on the control panel of the machine, affecting print quality accordingly. • Normal: This setting prints images in the normal mode. • Text Enhance: This setting refines the print quality of characters by smoothing out jagged edges that can occur on the angles and curves of each character. • Image Enhance: This setting refines the print quality of photo images.

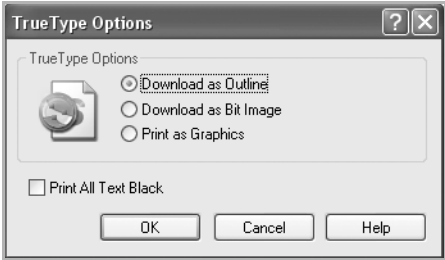
Property	Description
<p>3 Toner Save Mode</p>	<p>Selecting this option extends the life of your toner cartridge and reduces your cost per page without a significant reduction in the print quality.</p> <ul style="list-style-type: none"> • Printer Setting: When you select this option, the Toner Save feature is determined by the setting you've made on the control panel of the machine affecting print quality accordingly. • On: Select this option to allow the machine to use less toner on each page. • Off: When you do not need to save toner to print a document, select this option.
<p>4 TrueType Options</p>	<p>You can use advanced settings by clicking the TrueType Options button.</p>  <p>TrueType Options</p> <p>This option determines how the driver tells the machine to image the text in your document. Select the appropriate setting according to the status of your document.</p> <ul style="list-style-type: none"> • Download as Outline: When this option is selected, the driver will download any TrueType fonts that are used in your document that are not already stored (resident) in your machine. If, after printing a document, you find that the fonts did not print correctly, choose Download as Bit Image and resubmit your print job. The Download as Bit Image setting is often useful when printing Adobe. • Download as Bit Image: When this option is selected, the driver downloads the font data as bitmap images. Documents with complicated fonts, such as Korean or Chinese, or various other types of fonts, print faster in this setting.

Property	Description
<p>4 TrueType Options (continued)</p>	<ul style="list-style-type: none"> • Print as Graphics: When this option is selected, the driver downloads any fonts as graphics. When printing documents with high graphic content and relatively few TrueType fonts, printing performance (speed) may be enhanced in this setting. <p>Print All Text Black</p> <p>When the Print All Text Black option is checked, all text in your document prints in solid black, regardless of the color it appears on the screen. When this option is not checked, colored text prints in shades of gray.</p>

Extras Tab

See page 4.2 for more information about accessing printer properties. Click the **Extras** tab to access the following features:

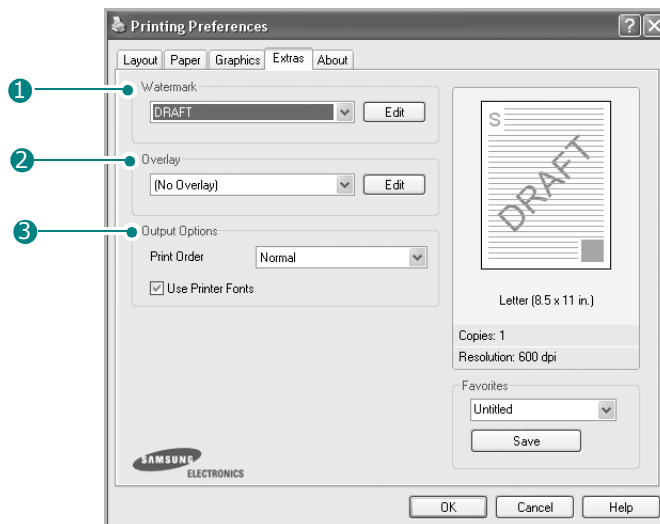

Option	Description
<p>1 Watermark</p>	<p>You can create a background image of text to print on each page of your document. See "Using Watermarks" on page 4.18.</p>

Option	Description
<p>2 Overlay</p>	<p>Overlays are often used to take the place of preprinted forms and letterhead paper. See "Using Overlays" on page 4.21.</p>
<p>3 Output Options</p>	<p>Print Order: You can set the sequence for the pages to print. Select the print order from the drop-down list.</p> <ul style="list-style-type: none"> • Normal: Your machine prints all pages from the first page to the last page. • Reverse All Pages: Your machine prints all pages from the last page to the first page. • Print Odd Pages: Your machine prints only the odd numbered pages of the document. • Print Even Pages: Your machine prints only the even numbered pages of the document. <p>Use Printer Fonts: When this option is selected, the machine uses the fonts that are stored in its memory (resident fonts) to print your document, rather than downloading the fonts used in your document. Because downloading fonts takes time, selecting this option can speed up your printing time.</p>

About Tab

Use the **About** tab to display the copyright notice and the version number of the driver. If you have an Internet browser, you can connect to the Internet by clicking on the web site icon. See page 4.2 for more information about accessing printer properties.

Printer Tab

If you access printer properties through the **Printers** folder, you can view the **Printer** tab. Click the **Printer** tab to access the following properties:

- **Optional Tray:** If you install an optional Tray 2, in the printer properties window, you can tell the machine to recognize and use it for PC-printing by selecting **Tray 2** in the **Optional Tray** drop down list.
- **High Altitude Correction:** If your machine is going to be used at an altitude above 1,500 m, checking this option will optimize the print quality for those circumstances.

Using a Favorite Setting

The **Favorites** option, available on each tab, except for the **About** tab, allows you to save the current properties settings for future use.

To save a Favorites item:

- 1 Change the settings on each tab, as needed.
- 2 Enter a name for the item in the **Favorites** input box.

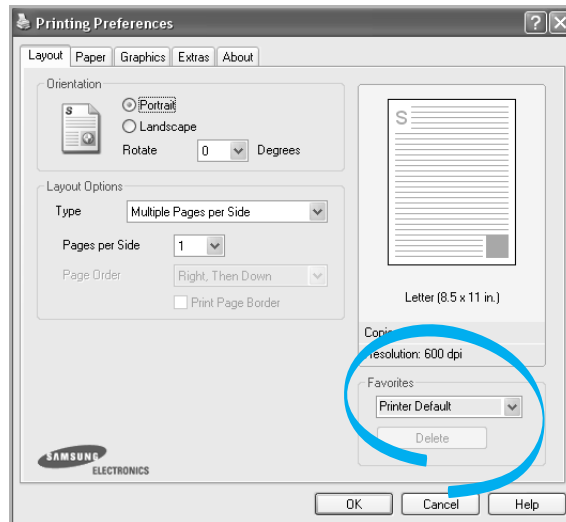

- 3 Click **Save**.

To use a saved setting, select it from the **Favorites** drop-down list.

To delete a favorite setting item, select it from the list and click **Delete**.

You can also restore the printer driver's default settings by selecting **Printer Default** from the list.

Using Help

Your machine has a help screen that can be activated using the **Help** button in the printer properties window. The help screen gives detailed information about the printer features provided by the printer driver.

You can also click **?** in the upper right hand corner, and then click on any setting.

Printing Multiple Pages on One Sheet of Paper

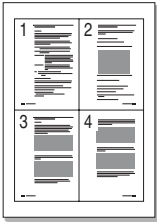

You can select the number of pages to print on a single sheet of paper. To print more than one page per sheet, the pages are reduced in size and arranged in the order you specify. You can print up to 16 pages on one sheet.

- 1 To change the print settings from your software application, access printer properties. See page 4.2.
- 2 From the **Layout** tab, choose **Multiple Pages per Side** from the **Type** drop-down list.



NOTE: This feature is not available when you select **Fit to Page** or **Reduce/Enlarge** from the **Paper** tab.

- 3 Select the number of pages you want to print per sheet (1, 2, 4, 6, 9, or 16) on the **Pages per Side** drop-down list.

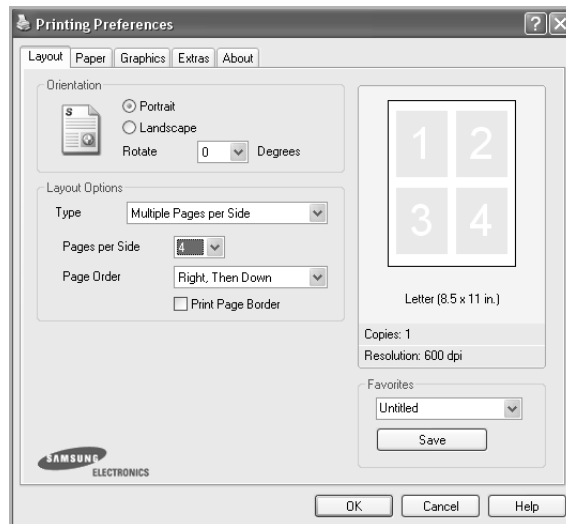

- 4 Select the page order on the **Page Order** drop-down list, if necessary.



Right, Then
Down



Down, Then
Right



Left, Then
Down



Down, Then
Left

Check **Print Page Border** to print a border around each page on the sheet.



NOTE: Page Order and **Print Page Border** are enabled only when the number of pages per side is 2, 4, 6, 9, or 16.

- 5 Click the **Paper** tab and select the paper source, size, and type.
- 6 Click **OK** and print the document.

Printing Posters

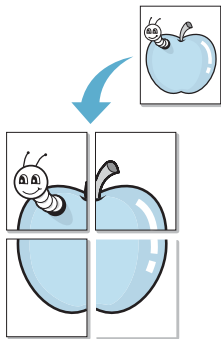

You can print a single-page document onto 4, 9, or 16 sheets of paper, for the purpose of pasting the sheets together to form one poster-sized document.

- 1 To change the print settings from your software application, access printer properties. See page 4.2.
- 2 From the **Layout** tab, select **Poster** on the **Type** drop-down list.

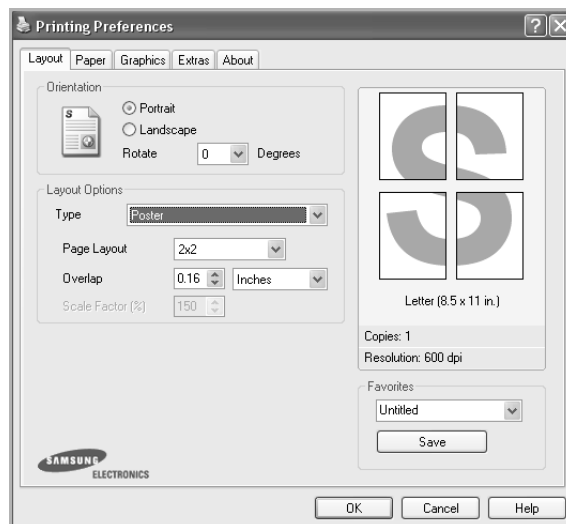

NOTE: This feature is not available when you select **Fit to Page** or **Reduce/Enlarge** from the **Paper** tab.

3 Configure the poster option:

You can select the page layout from **2x2**, **3x3**, **4x4**, or **Custom**. If you select **2x2**, the image is automatically stretched to cover 4 physical pages.

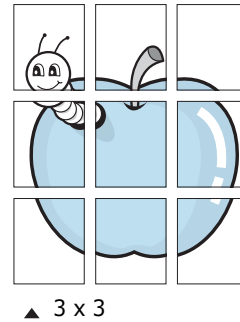
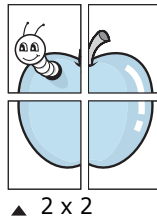

If you select **Custom**, you can manually set the scale rate of the image in the **Scale Factor** input box.

Specify an overlap in millimeters or inches to make it easier to reconstruct the resulting poster.

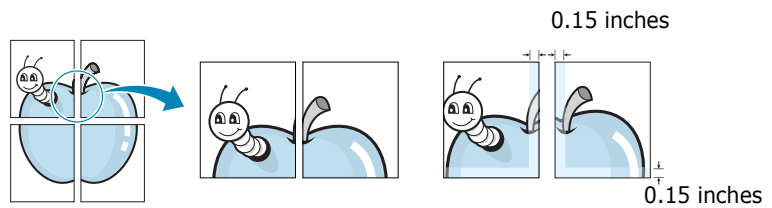

- 4** Click the **Paper** tab and select the paper source, size, and type.
- 5** Click **OK** and print the document. You can complete the poster by pasting the sheets together.

Fitting Your Document to a Selected Paper Size

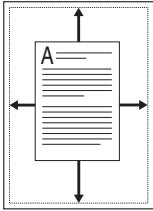

You can scale your print job to any paper size regardless of the original document size. This can be useful when you want to check the fine details on a small document.

- 1 To change the print settings from your software application, access printer properties. See page 4.2.
- 2 From the **Paper** tab, select **Fit to Page** on the **Type** drop-down list.



NOTE: This feature is not available when you select **Poster** or **Multiple Pages per Side** from the **Layout** tab.

- 3 Select the correct size from the **Target Page** drop-down list.

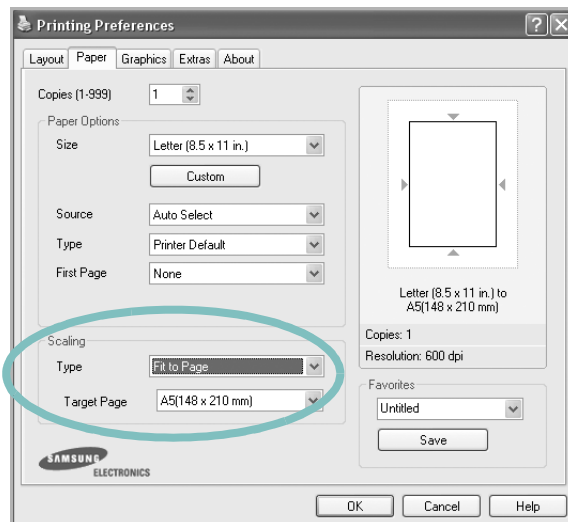

- 4 Click the **Paper** tab and select the paper source and type.
- 5 Click **OK** and print the document.

Printing a Reduced or Enlarged Document

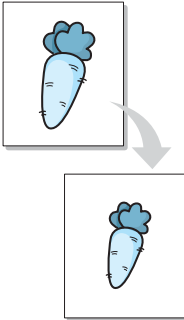

You can change the size of a page's content to appear larger or smaller on the printed page.

- 1 To change the print settings from your software application, access printer properties. See page 4.2.
- 2 From the **Paper** tab, select **Reduce/Enlarge** on the **Type** drop-down list.
- 3 Enter the scaling rate in the **Percentage** input box.

You can also click the ▲ or ▼ button.

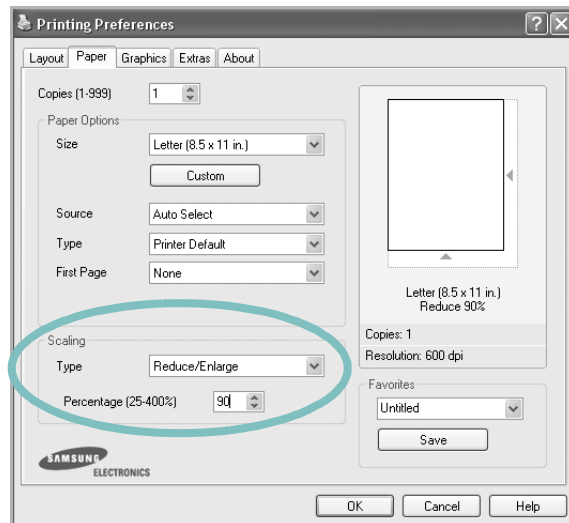

NOTE: This feature is not available when you select **Poster** or **Multiple Pages per Side** from the **Layout** tab.

- 4 Click the **Paper** tab and select the paper source, size, and type.
- 5 Click **OK** and print the document.

Using Watermarks



The Watermark option allows you to print text over an existing document. For example, you may want to have large gray letters reading "DRAFT" or "CONFIDENTIAL" printed diagonally across the first page or all of the pages of a document.

There are several predefined watermarks that come with your machine, and they can be modified or you can add new ones to the list.

Using an Existing Watermark

- 1 To change the print settings from your software application, access printer properties. See page 4.2.
- 2 Click the **Extras** tab and select a watermark on the **Watermark** drop-down list. It appears in the preview image window.

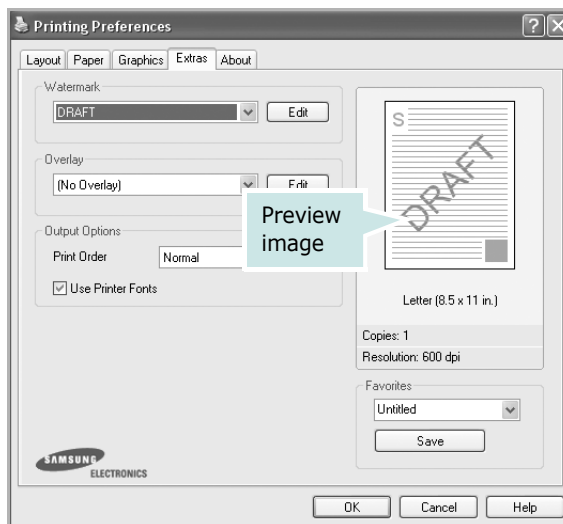

- 3 Click **OK** and start printing.

Creating a Watermark

- 1 To change the print settings from your software application, access printer properties. See page 4.2.
- 2 Click the **Extras** tab and click **Edit** in the **Watermark** section. The Edit Watermark window appears.

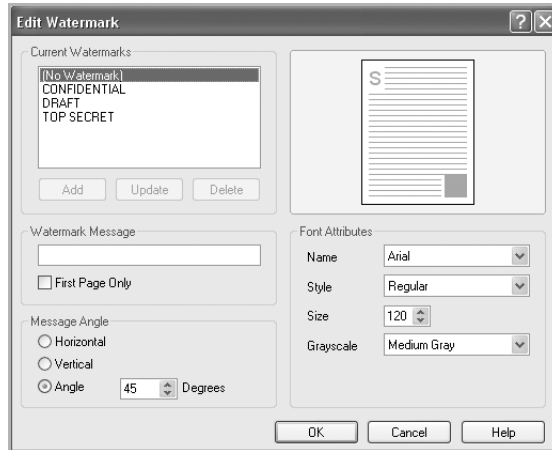

- 3 Enter the text message you want to print in the **Watermark Message** box.

The message displays in the preview image window.

When the **First Page Only** box is checked, the watermark prints on the first page only.

- 4 Select the watermark options.

You can select the font name, style, size, and gray scale level from the **Font Attributes** section and set the angle of the watermark from the **Message Angle** section.

- 5 Click **Add** to add the new watermark to the list.

- 6 When you finish creating, click **OK** and start printing.

To stop printing the watermark, select **[No Watermark]** on the **Watermark** drop-down list.

Editing a Watermark

- 1 To change the print settings from your software application, access printer properties. See page 4.2.
- 2 Click the **Extras** tab and click **Edit** in the **Watermark** section. The Edit Watermark window appears.
- 3 Select the watermark you want to edit on the **Current Watermarks** list. You can change the watermark message and the options. Refer to page 4.19.
- 4 Click **Update** to save the changes.
- 5 Click **OK**.

Deleting a Watermark

- 1 To change the print settings from your software application, access printer properties. See page 4.2.
- 2 From the **Extras** tab, click **Edit** in the **Watermark** section. The Edit Watermark window appears.
- 3 Select the watermark you want to delete on the **Current Watermarks** list and click **Delete**.
- 4 Click **OK**.

Using Overlays

What is an Overlay?



An overlay is text and/or images stored on the computer hard disk drive (HDD) as a special file format that can be printed on any document. Overlays are often used to take the place of preprinted forms and letterhead paper. Rather than using preprinted letterhead, you can create an overlay containing the exact same information that is currently on your letterhead. To print a letter with your company's letterhead, you need only tell the machine to print the letterhead overlay on your document.

Creating a New Page Overlay

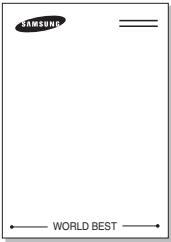

To use a page overlay, you must create a page overlay containing a logo or image.

- 1 Create or open a document containing text or an image for use in a new page overlay. Position the items exactly as you wish them to appear when printed as an overlay.
- 2 To save the document as an overlay, access printer properties. See page 4.2.
- 3 Click the **Extras** tab and click **Edit** in the **Overlay** section.

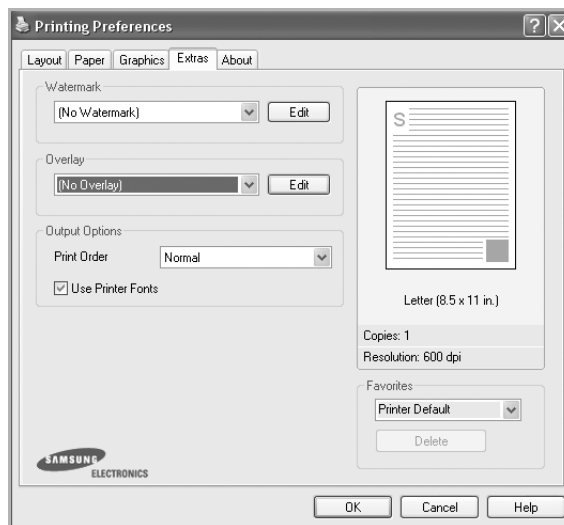

- In the Edit Overlay window, click **Create Overlay**.

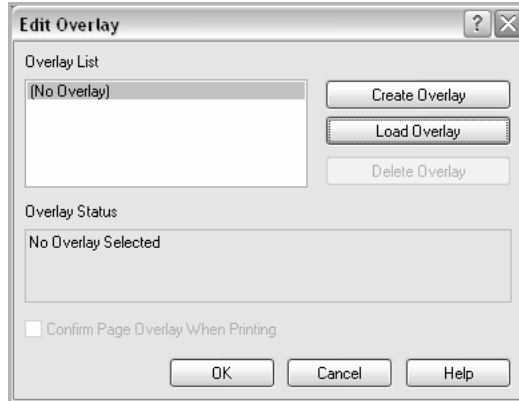

- In the Create Overlay window, type a name of up to eight characters in the **File name** box. Select the destination path, if necessary. (The default is C:\Formover).

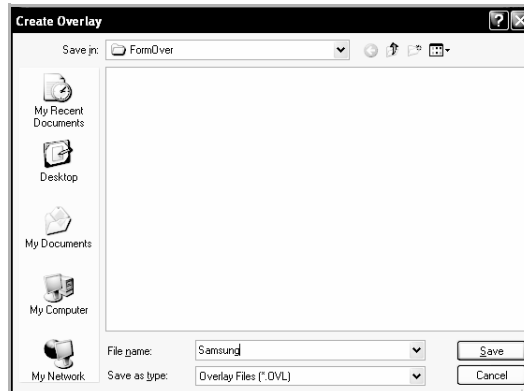

- Click **Save**. The name appears on the Overlay List.
- Click **OK** or **Yes** to finish creating.

The file is not printed out. Instead it is stored in your computer HDD disk.



NOTE: The overlay document size must be the same as the documents you print with the overlay.

Using a Page Overlay

After an overlay has been created, it is ready to be printed with your document. To print an overlay with a document:

- Create or open the document you want to print.

- 2 To change the print settings from your software application, access printer properties. See page 4.2.
- 3 Click the **Extras** tab.
- 4 Select the overlay you want to print from the **Overlay** drop-down list box.
- 5 If the overlay file you want doesn't appear on the Overlay List, click **Edit** and **Load Overlay**, and select the overlay file.



If you have stored the overlay file you want to use in an external source, you can also load the file when you access this Load Overlay window.

After you select the file, click **Open**. The file appears on the Overlay List and is available for printing. Select the overlay from the **Overlay List** box.

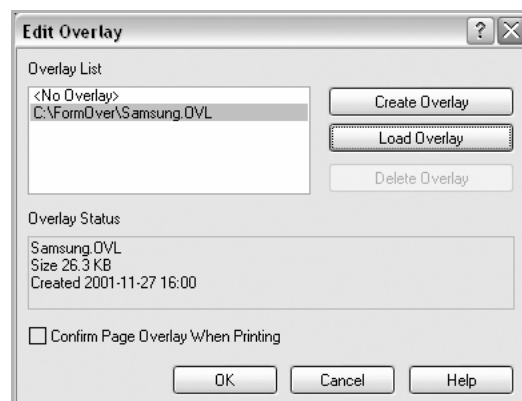

- 6 If necessary, click **Confirm Page Overlay When Printing**. When this box is checked, a message window appears each time you submit a document for printing, asking you to confirm your wish to print an overlay on the document.

Answering **Yes** in the window means that the selected overlay prints with your document. Answering **No** to the window cancels overlay printing.

If this box is empty and an overlay has been selected, the overlay will be automatically printed with your document.

- 7 Click **OK** or **Yes** until the printing starts.

The overlay downloads with your print job and prints on your document.



NOTE: The resolution of the overlay document must be the same as that of the document you will print with the overlay.

Deleting a Page Overlay

You can delete page overlays that you no longer use.

- 1 In the printer properties window, click the **Extras** tab.
- 2 Click **Edit** in the Overlay section.
- 3 Select the overlay you want to delete from the Overlay List box.
- 4 Click **Delete Overlay**.
- 5 When a confirmation message window appears, click **Yes**.
- 6 Click **OK** until you exit the Print window.



5

COPYING

This chapter gives you step-by-step instructions for copying documents.

This chapter includes:

- **Loading Paper for Copying**
- **Selecting the Paper Tray**
- **Preparing a Document**
- **Making Copies on the Document Glass**
- **Making Copies from the Automatic Document Feeder**
- **Setting Copy Options**
- **Using Special Copy Features**
- **Changing the Default Settings**
- **Setting the Time Out Option**

Loading Paper for Copying

The instructions for loading print materials are the same whether you are printing, faxing, or copying. For further details, see page 2.7 for loading in the paper tray and page 3.6 for loading in the Multipurpose tray.



NOTE: For copying, you can only use Letter-, A4-, Legal-, Folio-, Executive-, B5-, A5-, or A6-sized print materials.

Selecting the Paper Tray

After loading the print media for copy output, you have to select the paper tray you will use for the copy job.

1 Press **Menu** on the control panel.

The first available menu item, "Paper Setting," appears on the top line of the display and "Copy Tray" appears on the bottom line of the display.

2 Press **Enter**.

3 Press the scroll button (◀ or ▶) until the paper tray you want appears on the display.

You can select Tray1, Tray2, MP Tray, Tray1/2, or Auto. If you do not install the optional Tray 2, the Tray2 and Tray1/2 menu item will not appear on the display.

4 Press **Enter** to save the selection.

5 To return to Standby mode, press **Stop/Clear**.

Preparing a Document

You can use the document glass or the Automatic Document Feeder (ADF) to load an original document for copying, scanning, and sending a fax. Using the ADF, you can load up to 50 documents (47 ~ 105 g/m², 12.5 ~ 28 lb) for one job. You can, of course, place only one sheet at a time on the document glass.

When you use the ADF:

- Do not load documents smaller than 142 x 127 mm or larger than 216 x 356 mm.
- Do not attempt to feed the following types of documents:
 - carbon-paper or carbon-backed paper
 - coated paper
 - onion skin or thin paper
 - wrinkled or creased paper
 - curled or rolled paper
 - torn paper
- Remove all staples and paper clips before loading documents.
- Make sure any glue, ink, or correction fluid on the paper is completely dry before loading documents.
- Do not load documents that include different sizes or weights of paper.
- Do not load booklet, pamphlet, transparencies, or documents having other unusual characteristics.

Making Copies on the Document Glass

- 1 Lift and open the document cover.

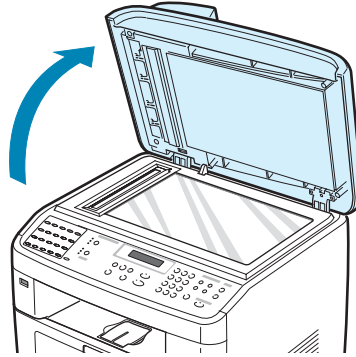

- 2 Place the document **face down** on the document glass and align it with the registration guide at the top left corner of the glass.

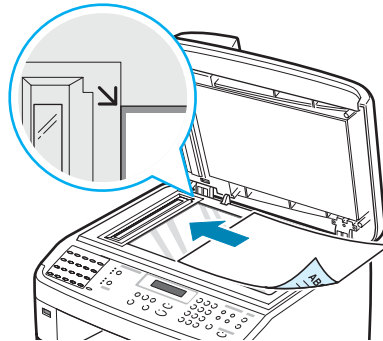

NOTE: Make sure that no documents are in the ADF (Automatic Document Feeder). If a document is detected in the ADF, the machine gives it priority over the document on the document glass.

- 3 Close the document cover.



NOTES:

- Leaving the cover open while copying may affect copy quality and toner consumption.
 - If you are copying a page from a book or magazine, lift the cover until its hinges are caught by the stopper and then close the cover. If the book or magazine is thicker than 30 mm, start copying with the cover open.
-

- 4 Customize the copy settings including number of copies, copy size, darkness, and original type, by using the control panel buttons. See "Setting Copy Options" on page 5.7.

To clear the settings, use the **Stop/Clear** button.

- 5 If necessary, you can use special copy features, such as Poster, Auto Fit, Clone, and 2Sides on 1pg copying.

- 6 Press **Start** to begin copying.

The display shows the copy processing.



NOTES:

- You can cancel the copy job during an operation. Press **Stop/Clear**, and the copying will stop.
 - Dust on the document glass may cause black spots on the printout. Always keep it clean.
 - To get the best scan quality, especially for colored or gray-scaled images, use the document glass.
-

Making Copies from the Automatic Document Feeder

- 1 Load the document **face up** into the ADF (Automatic Document Feeder). You can insert up to 50 sheets at a time. Make sure that the bottom of the document stack matches the paper size marked on the document tray.

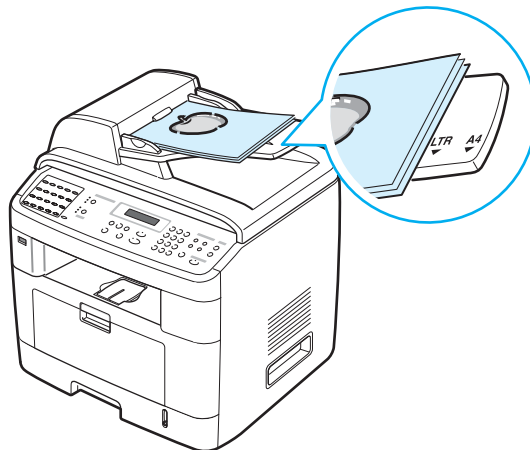

- 2 Adjust the document guides to the document size.

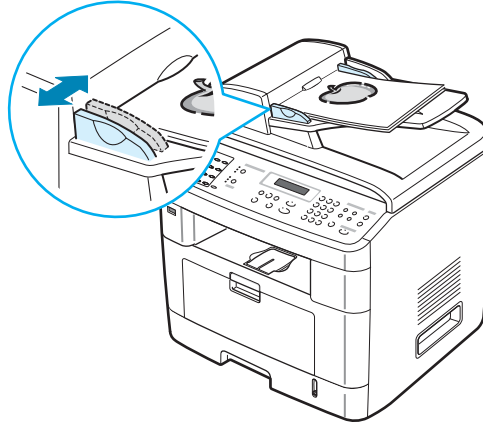

- 3 Customize the copy settings including number of copies, copy size, darkness, and original type, by using the control panel buttons. See "Setting Copy Options" on page 5.7.

To clear the settings, use the **Stop/Clear** button.

- 4 If necessary, you can use special copy features, such as Collation and 2 or 4 Up-copying.

- 5 Press **Start** to begin copying.

The display shows the copy processing.



NOTE: Dust on the ADF glass may cause black lines on the printout. Always keep it clean.

Setting Copy Options

The buttons on the control panel let you select all basic copy options: darkness, document type, copy size, and number of copies. Set the following options for the current copy job before pressing **Start** to make copies.



NOTE: If you press **Stop/Clear** while setting the copy options, all of the options you have set for the current copy job will be canceled and returned to their default status. Or, they will automatically return to their default status after the machine completes the copy in progress.

Darkness

If you have an original document containing faint markings and dark images, you can adjust the brightness to make a copy that is easier to read.

To adjust the contrast, press **Darkness**.

Each time you press the button, the LED labeled with the selected mode lights.

You can choose from the following contrast modes:

- **Light:** works well with dark print.
- **Normal:** works well with standard typed or printed documents.
- **Dark:** works well with light print or faint pencil markings.

Original Type

The Original Type setting is used to improve the copy quality by selecting the document type for the current copy job.

To select the document type, press **Original Type**.

Each time you press the button, the LED labeled with the selected mode lights.

You can choose from the following image modes:

- **Text:** Use for documents containing mostly text.
- **Text/Photo:** Use for documents with mixed text and photographs.
- **Photo:** Use when the originals are photographs.



NOTE: When you copy a document containing color on the background, such as a newspaper or a catalog, the background will appear on your copy. If you want to reduce the background, change the **Darkness** setting to **Light** and/or the **Original Type** setting to **Text**.

Reduced/Enlarged Copy

Using the **Reduce/Enlarge** button, you can reduce or enlarge the size of a copied image from 25% to 400% when you copy original documents from the document glass or from 25% to 100% from the ADF. Note that the zoom rate available is different depending on the document loading method.

To select from the predefined copy sizes:

1 Press **Reduce/Enlarge**.

The default setting appears on the bottom line of the display.

2 Press **Reduce/Enlarge** or the scroll button (◀ or ▶) to find the size setting you want.

3 Press **Enter** to save the selection.

To fine-tune the size of copies:

1 Press **Reduce/Enlarge**.

2 Press **Reduce/Enlarge** or the scroll button (◀ or ▶) until "Custom:25-100%" or "Custom:25-400%" displays on the bottom line. Press **Enter**.

3 Press the scroll button (◀ or ▶) until the copy size you want appears on the display.

Pressing and holding the button allows you to quickly scroll to the number you want.

You can enter the value using the number keypad.

4 Press **Enter** to save the selection.



NOTE: When you make a reduced copy, black lines may appear at the bottom of your copy.

Number of Copies

Using the **No. of Copies** button, you can select the number of copies from 1 to 99.

- 1 Press **No. of Copies**.
- 2 Press the scroll button (◀ or ▶) until the number you want appears on the display.

Pressing and holding the button allows you to quickly scroll to the number you want.

You can enter the value using the number keypad.

- 3 Press **Enter** to save the selection.

Using Special Copy Features

5

You can use the following copy features using the **Special Copy** button on the control panel:

- **Off:** Prints in normal mode.
- **Clone:** Prints multiple image copies from the original document on a single page. The number of images is automatically determined by the original image and paper size. See page 5.10.
- **Copy Collate:** Sorts the copy job. For example, if you make 2 copies of a 3 page document, one complete 3 page document will print followed by the second complete document. See page 5.10.
- **Auto Fit:** Automatically reduces or enlarges the original image to fit on the paper currently loaded in the machine. See page 5.11.
- **2 sides in 1pg:** Prints 2-sided original document on one sheet of paper. See page 5.11.
- **2/4 Up:** Prints 2/4 original images reduced to fit onto one sheet of paper. See page 5.12.
- **Poster:** Prints an image onto 9 sheets of paper (3x3). You can paste the printed pages together to make one poster-sized document. See page 5.13.



NOTE: Some features may not be available depending on where you loaded the document, on the document glass or in the Automatic Document Feeder.

Clone Copying

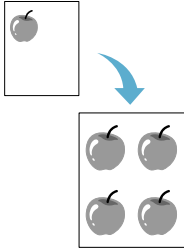

This special copy feature can be applied only when you place a document on the document glass. If a document is detected in the ADF, Clone copying feature does not work.

- 1 Place the document to be copied on the document glass, and close the cover.
- 2 Press **Special Copy**.
- 3 Press **Special Copy** or the scroll button (◀ or ▶) until "Clone" displays on the bottom line.
- 4 Press **Enter** to make your selection.
- 5 If necessary, customize the copy settings, including number of copies, darkness, and original type, by using the control panel buttons. See "Setting Copy Options" on page 5.7.



NOTE: You cannot adjust the copy size using the **Reduce/Enlarge** button while making a clone copy.

- 6 Press **Start** begin copying.

Collation Copying

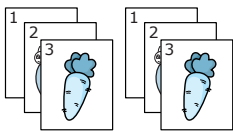

This special copy feature is available only when you load documents in the ADF.

- 1 Load the documents to be copied in the ADF.
- 2 Press **Special Copy**.
- 3 Press **Special Copy** or the scroll button (◀ or ▶) until "Copy Collate" displays on the bottom line.
- 4 Press **Enter** to make your selection.
- 5 If necessary, customize the copy settings, including number of copies, darkness, and original type, by using the control panel buttons. See "Setting Copy Options" on page 5.7.
- 6 Press **Start** to begin copying.

Auto Fit Copying

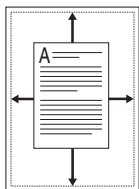

This special copy feature can be applied only when you place a document on the document glass. If a document is detected in the ADF, Auto Fit copying does not work.

- 1 Place the document to be copied on the document glass, and close the cover.
- 2 Press **Special Copy**.
- 3 Press **Special Copy** or the scroll button (◀ or ▶) until "Auto Fit" appears on the bottom line.
- 4 Press **Enter** to make your selection.
- 5 If necessary, customize the copy settings, including number of copies, darkness, and original type, by using the control panel buttons. See "Setting Copy Options" on page 5.7.



NOTE: You cannot adjust the copy size using the **Reduce/Enlarge** button while Auto Fit copying is enabled.

- 6 Press **Start** to begin copying.

2 Sides on 1 Page Copying

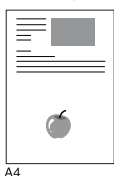
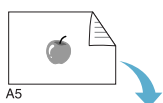

You can copy a 2-sided document on one side of one page of A4-, Letter-, Legal-, Folio-, Executive-, B5-, A5-, or A6-sized paper.

When you copy using this feature, the machine prints one side of the document on the upper half of the paper and the other side on the lower half without reducing the size of the original. This feature is helpful for copying a small-sized document, such as a name card.

If the original document is larger than the printable area, some portions may not be printed.

This special copy feature can be applied only when you place a document on the document glass. If a document is detected in the ADF, 2 Sides on 1 Page copying feature does not work.

- 1 Place the document to be copied on the document glass and close the cover.
- 2 Press **Special Copy**.

- 3 Press **Special Copy** or the scroll button (◀ or ▶) until "2 sides in 1pg" displays on the bottom line.
- 4 Press **Enter** to make your selection.
- 5 If necessary, customize the copy settings, including number of copies, darkness, and original type, by using the control panel buttons. See "Setting Copy Options" on page 5.7.
- 6 Press **Start** to begin copying.
Your machine begins scanning the front side.
- 7 When "Set Backside" displays on the bottom line, open the document cover and flip the document over. Close the cover.



NOTE: If you press the **Stop/Clear** button or if no buttons are pressed for approximately 30 seconds, the machine cancels the copy job and returns to Standby mode.

- 8 Press **Start** again.

2 Up or 4 Up Copying

This copy feature is available only when you load documents in the ADF.



▲ 2-up copying



▲ 4-up copying

- 1 Load the documents to be copied in the ADF.
- 2 Press **Special Copy**.
- 3 Press **Special Copy** or the scroll button (◀ or ▶) until "2 UP" or "4 UP" displays on the bottom line.
- 4 Press **Enter** to make your selection.
- 5 If necessary, customize the copy settings, including number of copies, darkness, and original type, by using the control panel buttons. See "Setting Copy Options" on page 5.7.



NOTE: You cannot adjust the copy size using the **Reduce/Enlarge** button for making a 2 or 4 Up copy.

- 6 Press **Start** to begin copying.

Poster Copying

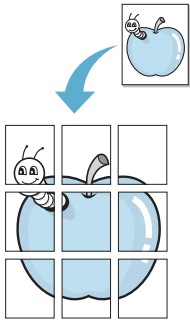

This special copy feature can be applied only when you place a document on the document glass. If a document is detected in the ADF, the Poster copying feature does not work.

- 1 Place the document to be copied on the document glass and close the cover.
- 2 Press **Special Copy**.
- 3 Press **Special Copy** or the scroll button (◀ or ▶) until "Poster" displays on the bottom line.
- 4 Press **Enter** to make your selection.
- 5 If necessary, customize the copy settings, including number of copies, darkness, and original type, by using the control panel buttons. See "Setting Copy Options" on page 5.7.



NOTE: You cannot adjust the copy size using the **Reduce/Enlarge** button when making a poster.

- 6 Press **Start** to begin copying.

Your original document is divided into 9 portions. Each portion is scanned and printed one by one in the following order:

1	2	3
4	5	6
7	8	9

Changing the Default Settings

The copy options, including darkness, original type, copy size and number of copies, can be set to the most frequently used modes. When you copy a document, the default settings are used unless they are changed by using the corresponding buttons on the control panel.

To create your own default settings:

- 1** Press **Menu** on the control panel until "Copy Setup" appears on the top line of the display.
The first menu item, "Default-Change," appears on the bottom line.
- 2** Press **Enter** to access the menu item. The first setup option, "Darkness," appears on the bottom line.
- 3** Press the scroll button (◀ or ▶) to scroll through the setup options.
- 4** When the option you want to set appears, press **Enter** to access the option.
- 5** Change the setting using the scroll button (◀ or ▶).
You can enter the value using the number keypad.
- 6** Press **Enter** to save the selection.
- 7** Repeat steps 3 through 6, as needed.
- 8** To return to Standby mode, press **Stop/Clear**.



NOTE: While you are setting copy options, pressing **Stop/Clear** cancels the changed settings and restores their default status.

Setting the Time Out Option

You can set the time the machine waits before it restores the default copy settings, if you do not start copying after changing them on the control panel.

- 1 Press **Menu** on the control panel until "Copy Setup" appears on the top line of the display.
- 2 Press the scroll button (◀ or ▶) to display "Timeout" on the bottom line.
- 3 Press **Enter** to access the menu item.
- 4 Press the scroll button (◀ or ▶) until the status you want appears on the display.

You can select from 15, 30, 60, 120, and 180 (seconds). Selecting "Off" means that the machine does not restore the default settings until you press **Start** to begin copying, or **Stop/Clear** to cancel.

- 5 Press **Enter** to make your selection.
- 6 To return to Standby mode, press **Stop/Clear**.

MEMO



6

SCANNING

Scanning with your machine lets you turn pictures and text into digital files on your computer. Then you can fax or e-mail the files, display them on your web site or use them to create projects that you can print using Samsung SmarThru software or the WIA driver. You can also use the Network Scan program to scan.

This chapter includes:

- **Scanning Basics**
- **Scanning From the Control Panel to an Application**
- **Scanning Using Samsung SmarThru**
- **Scanning Using the WIA Driver**
- **Scanning to USB Flash Drive**
- **Scanning Using the Network Scan**
- **Using the Network Scan driver**

Scanning Basics

Your SCX-4x20 Series offers four ways to scan. These are:

- From the control panel on your machine to an application: Use the **Scan-to** button on the control panel to initiate scanning. Assign the TWAIN-compliant software, such as Adobe Photo Deluxe or Adobe Photoshop, to the machine by selecting it from the list of available applications via the **Scan-to** button. Before assigning the software program, you must configure the scan list using the Printer Settings Utility. For details, see page 2.45.
- From the Samsung SmarThru software: Launch Samsung SmarThru and open Scan To to begin scanning. See page 6.4.
- From the Windows Images Acquisition (WIA) driver: Your machine also supports the WIA driver for scanning images. See page 6.7.
- From a USB flash drive: When you insert a USB flash drive into the USB port in the front of your machine, you can scan and save documents in the USB flash drive by pressing **Scan-to**. For details, see page 6.8.
- From the Network Scan Program: Your machine use the Network Scan program for scanning images. See page 6.9.



NOTES:

- To scan with your machine, you must install the MFP driver.
 - Scanning is done through the same LPT or USB port currently assigned for your printer port.
 - The maximum resolution that can be achieved depends upon various factors, including computer speed, available disk space, memory, the size of the image being scanned, and bit depth settings. Thus, depending on your system and what you are scanning, you may not be able to scan at certain resolutions, especially using enhanced dpi.
-

Scanning From the Control Panel to an Application

- 1** Make sure that your machine and computer are turned on and properly connected to each other.
- 2** Load the document(s) face up into the ADF.
OR
Place a single document face down on the document glass.
For details about loading a document, see page 7.6.
- 3** Press **Scan-to**. The first available menu item, "Application," appears on the bottom line.
- 4** Press **Enter** and press the scroll button (◀ or ▶) to select an application to which you want to send the scanned image.
- 5** Press **Enter**. The selected application window opens. Adjust the scan settings and start scan. For details, please refer to the User's Guide of the application.

Scanning Using Samsung SmarThru

Samsung SmarThru is the accompanying software for your machine. With SmarThru, scanning is the proverbial piece of cake.

Follow these steps to start scanning using the SmarThru:

1 Make sure that your machine and computer are turned on and properly connected to each other.

2 Load the document(s) face up into the ADF.

OR

Place a single document face down on the document glass.

For details about loading a document, see page 7.6.

3 Once you have installed Samsung SmarThru, you will see the **SmarThru 4** icon on your desktop. Double-click the **SmarThru 4** icon.

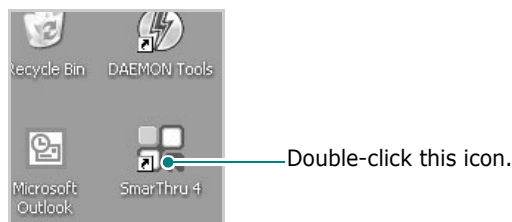

The SmarThru 4 window opens.



● Scan To

Allows you to scan an image and save it to an application or folder, email it, or publish it on a web site.

● Image

Allows you to edit an image you have saved as a graphic file and send it to a selected application or folder, email it, or publish it on a web site.

- **Copy**

Allows you to produce professional quality copies. You can make black and white or color copies of an image if your machine supports it, and customize the copy settings.

- **Print**

Allows you to print images you have saved. You can print images in black and white or color mode if your machine supports it.

- 4 Click **Scan To**. The **Scan To** menu bar appears on the SmarThru 4 window.

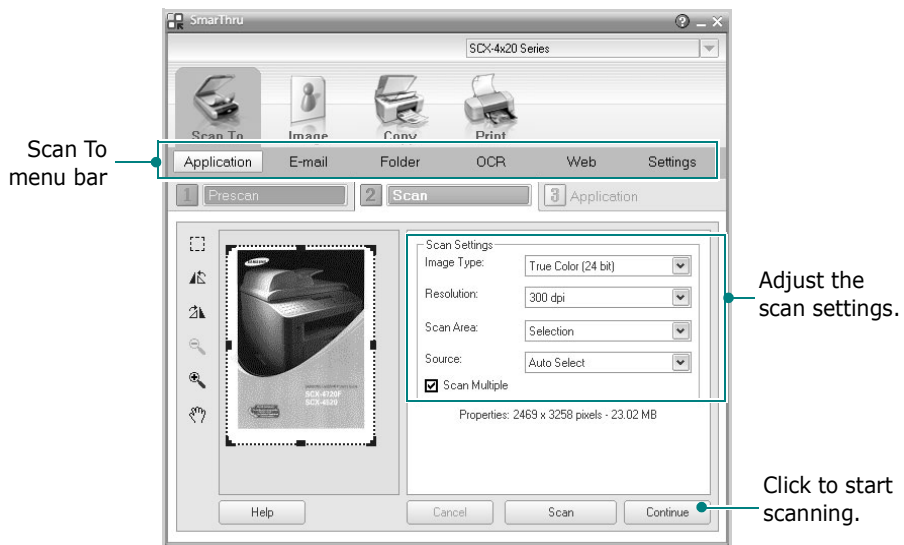

Scan To lets you use the following services:

- **Application**

Scanning an image and placing it in an image editor application, such as Paint or Adobe PhotoShop.

- **E-mail**

Scanning an image and emailing it. Allows you to scan an image, preview it, and email it.



NOTE: To send an image by e-mail, you must have a mail client program, like Outlook Express, which has been set up with your e-mail account.

- **Folder**

Scanning an image and saving it to a folder. Allows you to scan an image, preview it, and save it to the folder of your choice.

- **OCR**

Scanning an image and performing text recognition.

Allows you to scan an image, preview it, and send it to the OCR program for text recognition.

- Recommended Scan Option for OCR
- Resolution: 200 or 300 dpi
- Image Type: Grayscale or Black & White

- **Web**

Scanning an image, previewing it, and publishing it on a web site, using the specified file format for the image you want to publish.

- **Settings**

Customizing settings of **Scan To** basic functions. Allows you to customize settings for **Application**, **E-mail**, **OCR**, and **Web** functions.

- 5 Click the service icon according to your job.
- 6 SmarThru 4 opens for the selected service. Adjust the scan settings.
- 7 To start scanning, click **Scan**.



NOTE: If you want to cancel the scan job, click **Cancel**.

Using Onscreen Help File

For more information about SmarThru, click  at the top right corner of the window. The SmarThru Help window opens and allows you to view onscreen help supplied on the SmarThru program.

Scanning Using the WIA Driver

Your machine also supports the Windows Image Acquisition (WIA) driver for scanning images. WIA is one of the standard components provided by Microsoft® Windows® XP and works with digital cameras and scanners. Unlike the TWAIN driver, the WIA driver allows you to scan and easily manipulate images without using additional software.



NOTE: The WIA driver works only on Windows XP and USB port.

- 1 Load the document(s) face up into the ADF.
OR
Place a single document face down on the document glass.
For details about loading a document, see page 7.6.
- 2 From the **Start** menu on your desktop window, select **Settings, Control Panel**, and then **Scanners and Cameras**.
- 3 Double click your machine icon. The Scanner and Camera Wizard launches.
- 4 Choose your scanning preferences and click **Preview** to see how your preferences affect the picture.

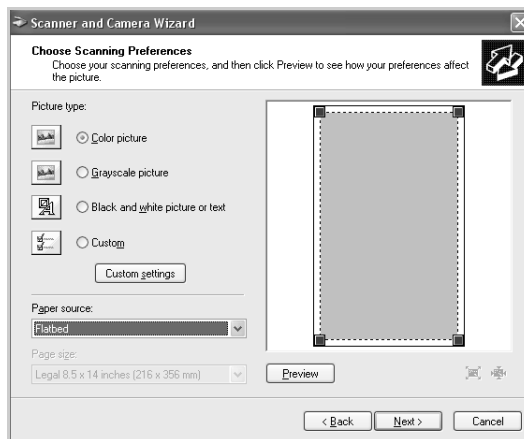

- 5 Click **Next**.
- 6 Enter a picture name, and select a file format and destination to save the picture.

- 7 Follow the on-screen instructions to edit the picture after it is copied to your computer.



NOTE: If you want to cancel the scan job, press the **Stop/Clear** button on the control panel.

Scanning to USB Flash Drive

Using a USB flash drive, you can scan and save documents in the USB flash drive by pressing **Scan-to** on the control panel. For details about scanning, see “Scanning to USB Flash Drive” on page 10.3.

Scanning Using the Network Scan

About Network Scan



NOTE: To use this function, you need to configure the network settings. For details, see “Setting Up a Network-Connected Machine” on page B.5.

Network Scan allows you to scan a document on your machine as a JPEG, TIFF or PDF and save it to a network-connected computer.

To use this feature, you must install the Network Scan program on the computer. For details about installing the program, see page 2.34.

Setting the Network Scan

From this menu, you can enable or disable scanning on your machine via a network-connected computer.

- 1** Press **Menu** on the control panel until “Maintenance” appears on the top line of the display.
- 2** Press the scroll button (◀ or ▶) until you see “Network Scan” on the bottom line and press **Enter**.
- 3** Press the scroll button (◀ or ▶), to select “Enable” or “Disable”.

Select “Enable” to use the Network Scan option. This is the default setting.

Select “Disable” if you do not want to use the Network Scan option.

- 4** Press **Enter** to complete your selection.

Scanning Using Network Scan

Using Network Scan you can scan a document from your machine to your computer through the network.

If you use SmarThru, you must initiate the scan procedure from the computer. Scanned data will go only to the computer which is directly connected to the machine.

Scanned documents can be saved as JPEG, TIFF or PDF files. You can also secure the scanned files by entering a user name and authentication code (PIN) via the number keypad on the front of your machine.

- 1 Load the document(s) face up into the ADF.

OR

Place a single document face down on the document glass.

For details about loading a document, see page 7.6.

- 2 Press **Scan-to** and select Network Scan. "Select User ID:" appears on the display.

- 3 Enter your ID and password using the number keypad, and then press **Enter**.

There are several different ways to provide a user ID:

- Enter full user ID through the keypad, or
- In **Smart Search**, enter characters in the top line of the LCD display and the bottom line will display the User IDs that begin with the entered character(s). "No Matches" displays in the lower line if no entries starting with the entered character are found. You can press **Enter** key and browse through the entries in the lower line starting with the entered character in the upper line by using the scroll button (◀ or ▶). You can press **Upper Level** button while browsing and enter the User ID through the keypad.

- 4 Enter your PIN to prevent other users from sending scanned documents to your computer. Press **Enter**. You can select the default password option to avoid this menu.

- 5 Press the scroll buttons (◀ or ▶) until "Scan Data" appears on the bottom line and press **Enter**.

- 6 Choose the file type and resolution and then press **Enter**.

- **Black & White**: If you select this option, select file type **PDF** or **TIFF**.
- **Color JPEG-200**: If you select this option, **200 dpi** resolution and **JPEG** file type will be automatically selected.
- **Resolution**: Select resolutions of 100 dpi, 200 dpi or 300 dpi.



NOTE: When you edit an image which has been scanned in 100 dpi resolution, the image may differ from the original image, depending on the program you use.

- 7 Press the scroll buttons (◀ or ▶) until "Start Scanning" displays and press **Enter**.

If you press **Enter** when the display shows "Logout", your machine returns to the Standby mode.

- 8 The document will be scanned to the computer where the Network Scan program is running.

If you have chosen **TIFF** or **PDF** as the file type, the display asks if you want to scan another document. If you need to scan more than one document, select "Yes" using the scroll button (◀ or ▶) and press **Enter**. The next document is scanned and stored. Repeat this until all documents have been scanned then select "No".

Setting Network Scan Timeout

If Network Scan on your computer does not send a refresh request and does not scan a job within the timeout period configured in Network Scan, the entry your machine returns to the Standby mode.

To set the Network Scan timeout option:

- 1 Press **Menu** until "Machine Setup" appears on the top line of the display.
- 2 Press the scroll buttons until "Scan Timeout" appears on the bottom line and then press **Enter**.
- 3 Enter the desired timeout value and press **Enter**.
The default value is 30 minutes. Users can enter any value from 1 minute to 1,440 minutes.
- 4 The change will be broadcast over the network and effective to all clients connected to the network.

Using the Network Scan driver

Adding a Scanner

To register your scanner as an authorized network scanner, use the Samsung Network Scan Manager window.

- 1 You can select **Start** → **Programs** → **Samsung Network Printer Utilities** → **Network Scan** → **Network Scan**.
- 2 In the Samsung Network Scan Manager window, click the **Add Device** button, or double-click the **Add Device** icon.

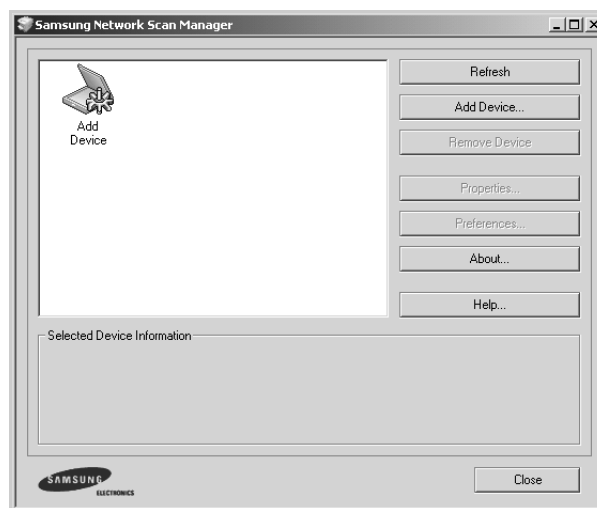

- 3 Click **Next**.

- 4 Select **Browse for a scanner. (recommended)**, or **Connect to this scanner.** and enter an IP address for the scanner, and click **Next**.

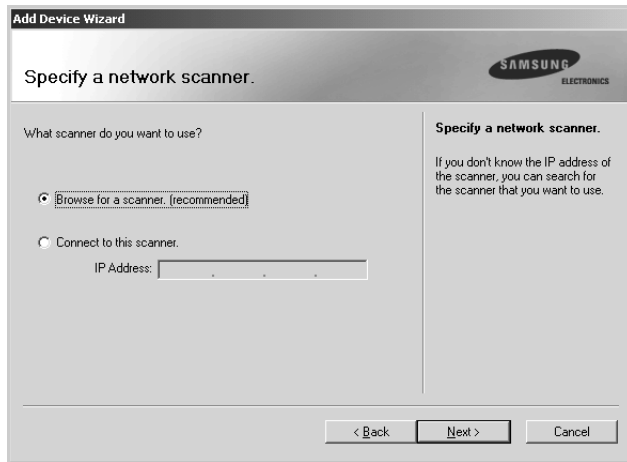

- 5 A list of scanners on your network appears. Select your machine from the list and enter the ID and PIN (Personal Identification Number) you will use. Click **Next**.
- For scanner's name, the model name of scanner you chose will be entered and changeable by users.
 - You can enter an ID of up to 8 characters. The first character must be a letter.
 - The PIN must be 4 digits.

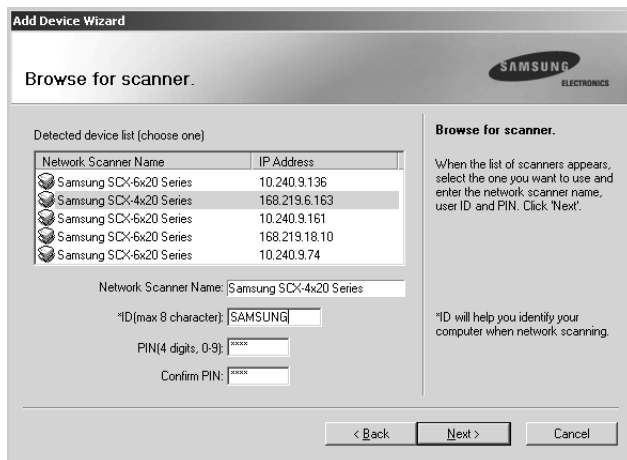

- 6 You have added your machine to the network. Click **Finish**. Your machine appears on the Samsung Network Scan Manager window and you can now scan through the network.

Removing a Scanner

To remove the authorized scanner, click the **Remove Device** button and follow the on-screen instruction to complete removing.

Use the **Help** button to see on-line help about the Network Scan program.

Setting the properties

- 1 In the Samsung Network Scan Manager window, double-click the scanner icon, or click the **Properties** button.

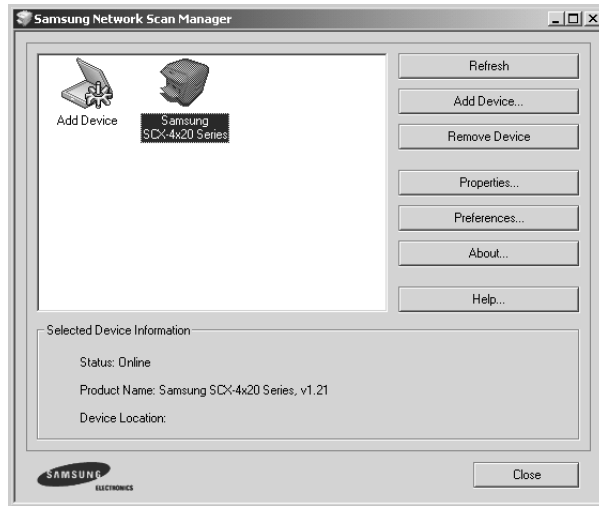

- 2 After setting the properties, click **OK**.

General Page

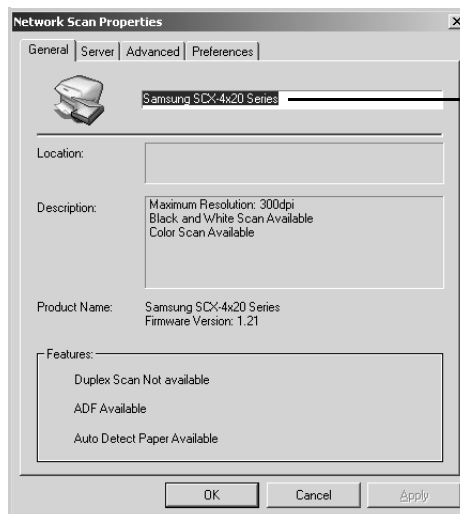

You can change the name of the scanner.

Server Page

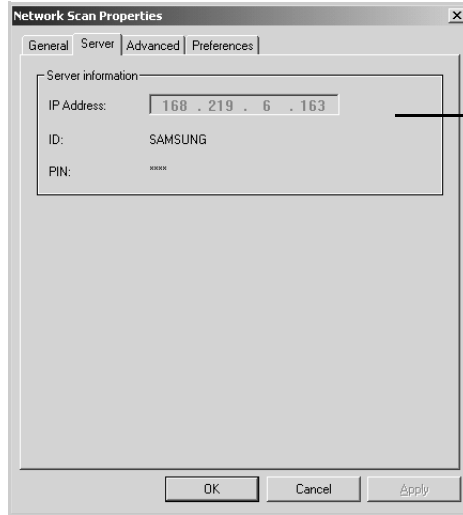

You can check the scanner's information.

Advanced Page

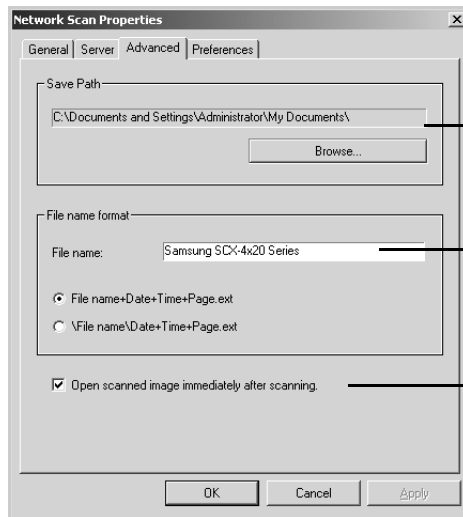

You can set the destination where scanned files are to be stored.

You can select the file name format.

You can open the scanned document immediately after scanning.

Preferences Page

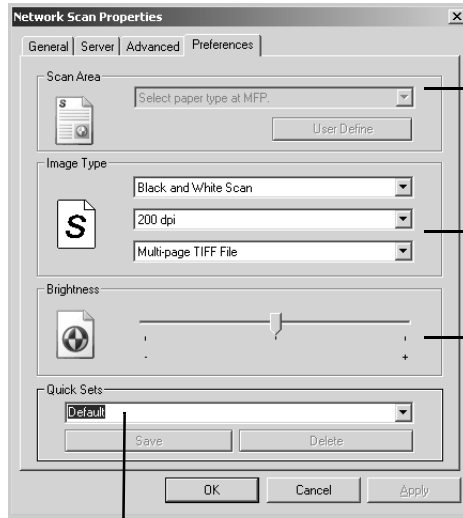

You can select the scan area you want. Click User Define to manually enter a scan area. For some scanners, the Scan Area option is not available.

You can select scan color, scan resolution, and file type.

You can adjust the brightness.

You can save and delete your settings and apply the saved settings.

Saving Quick Sets

- 1 Enter the settings you want to save.
- 2 Enter a Quick Sets name.
- 3 Click **Save** to save the settings.

Using Quick Sets

- 1 Select the setting you want to use from the Quick Sets drop-down list.
- 2 Click **OK** or **Apply**.

Deleting Quick Sets

- 1 Select the setting you want to delete from the Quick Sets drop-down list.
- 2 Click **Delete**.

Scanning using the Network Scan driver

- 1 Check the scanner's status by checking the scanner icon. See the next page.
- 2 Configure the network scanner settings. See "Setting the properties" on page 6.14.
- 3 Load the document you want to scan to the scanner you want to use.
- 4 Start scanning according to the recommendations of the User's Guide supplied with your scanner.
- 5 Scanning is started and the scanned document is sent to the location you specified.

The location can be changed in the Advanced Page in the Network Scan program's Properties screen. See page 6.15.

Scanner Icons

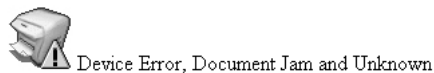
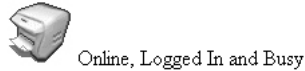

MEMO



7

FAXING

This chapter gives you information about using your machine as a fax machine.

This chapter includes:

- **Setting Up the Fax System**
- **Sending a Fax**
- **Receiving a Fax**
- **Automatic Dialing**
- **Other Ways to Fax**
- **Additional Features**

Setting Up the Fax System

Changing the Fax Setup options

- 1** Press **Menu** until "Fax Setup" appears on the top line of the display.
The first available menu item, "Receive Mode," displays on the bottom line.
- 2** Press the scroll button (◀ or ▶) until you see the desired menu item on the bottom line and press **Enter**.
- 3** Use the scroll button (◀ or ▶) to find the desired status or use the number keypad to enter the value for the option you have selected.
- 4** Press **Enter** to make your selection. The next Fax Setup option appears.
- 5** If necessary, repeat steps 2 through 4.
- 6** To return to Standby mode, press **Stop/Clear**.

Available Fax Setup Options

Option	Description
Receive Mode	<p>You can select the default fax receiving mode.</p> <ul style="list-style-type: none"> • In Tel mode, you can receive a fax by picking up the handset of the extension phone and then pressing the remote receive code (see page 7.4). Alternatively, you can press On Hook Dial (you can hear a fax tone from the remote machine) and then press Start on the control panel of your machine. • In the Fax mode, the machine answers an incoming call and immediately goes into fax reception mode. • In Ans/Fax mode, the answering machine answers an incoming call, and the caller can leave a message on the answering machine. If the fax machine senses a fax tone on the line, the call automatically switches to Fax mode. • In DRPD mode, you can receive a call using the Distinctive Ring Pattern Detection (DRPD) feature. This option is available only when you set up the DRPD Mode. For further details, see page 7.17.
Ring To Answer	<p>You can specify the number of times the machine rings, from 1 to 7, before answering an incoming call.</p>
Darkness	<p>You can select the default contrast mode to fax your documents lighter or darker.</p> <ul style="list-style-type: none"> • Light works well with dark print. • Normal works well with standard typed or printed documents. • Dark works well with light print or faint pencil markings.
Redial Term	<p>Your machine can automatically redial a remote fax machine if it was busy. Intervals from 1 to 15 minutes can be entered.</p>
Redials	<p>You can specify the number of redial attempts, from 0 to 13. If you enter 0, the machine will not redial.</p>

Option	Description
MSG Confirm	You can set your machine to print a report showing whether a transmission was successful, how many pages were sent, and more. The available options are On , Off , and On-Err , which prints only when a transmission is not successful.
Auto Report	This produces a report with detailed information about the previous 50 communications operations, including time and dates. The available options are On or Off .
Auto Reduction	<p>When receiving a document containing pages as long as or longer than the paper loaded in the paper tray, the machine can reduce the size of the document to fit the size of the paper loaded in the machine. Select On if you want to automatically reduce an incoming page.</p> <p>With this feature set to Off, the machine cannot reduce the document to fit onto one page. The document will be divided and printed in actual size on two or more pages.</p>
Discard Size	<p>When receiving a document containing pages as long as or longer than the paper installed in your machine, you can set the machine to discard any excess at the bottom of the page. If the received page is outside the margin you set, it will print in actual size on two or more sheets of paper.</p> <p>When the document is outside the margin and the Auto Reduction feature is turned on, the machine reduces the document to fit it onto the appropriately-sized paper and discard does not occur. If the Auto Reduction feature is turned off or fails, data outside the margin will be discarded. Settings range from 0 to 30 mm.</p>
RCV Start Code	The Receive Start Code allows you to initiate fax reception from an extension phone plugged into the EXT jack on the back of the machine. If you pick up the extension phone and hear fax tones, enter the Receive Start Code. The Receive Start Code is preset to *9* at the factory. Settings range from 0 to 9. See page 7.16 for more information about using the code.

Option	Description
DRPD Mode	You can receive a call using the Distinctive Ring Pattern Detection (DRPD) feature, which enables a user to use a single telephone line to answer several different telephone numbers. In this menu, you can set the machine to recognize which ring patterns to answer. For details about this feature, see page 7.17.

Sending a Fax

Loading a Document

You can use the Automatic Document Feeder (ADF) or the document glass to load an original document for faxing. Using the ADF, you can load up to 50 sheets of 75 g/m² (20 lb) paper at a time. You can, of course, place only one sheet at a time on the document glass. For details about preparing a document, see page 5.3.

To fax a document using the Automatic Document Feeder (ADF):

- 1 Load the document **face up** into the ADF. You can insert up to 50 sheets at a time. Make sure that the bottom of the document stack matches the paper size marked on the document tray.

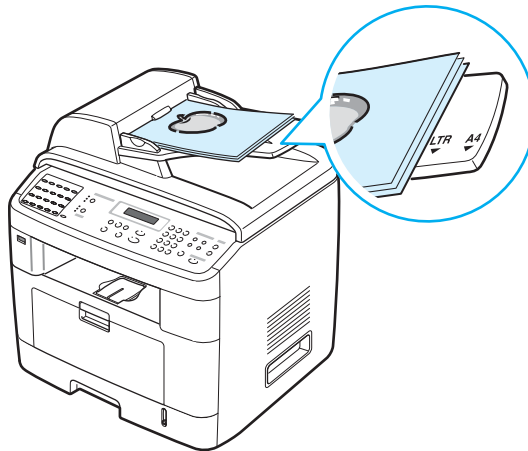

- 2 Adjust the document guide on the ADF to match the width of the document.

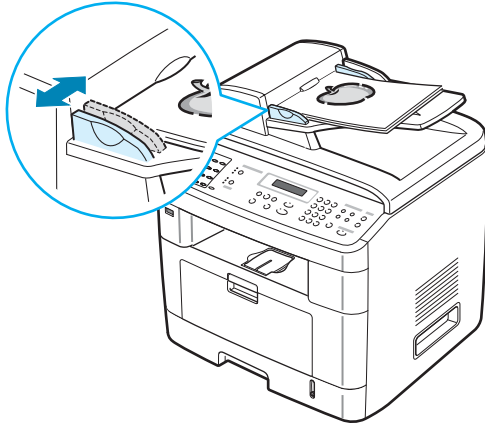

NOTE: Dust on the ADF glass may cause black lines on the printout. Keep it always clean.

To fax a document from the document glass:

- 1 Lift and open the document cover.

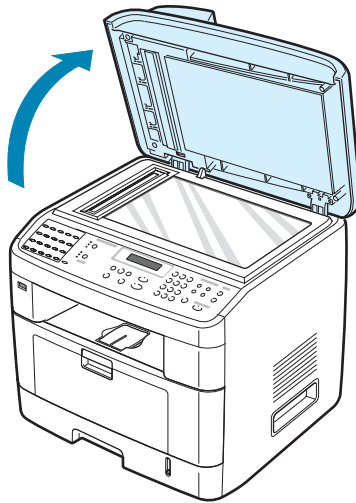

- 2 Place the document **face down** on the document glass and align it with the registration guide at the top left corner of the glass.

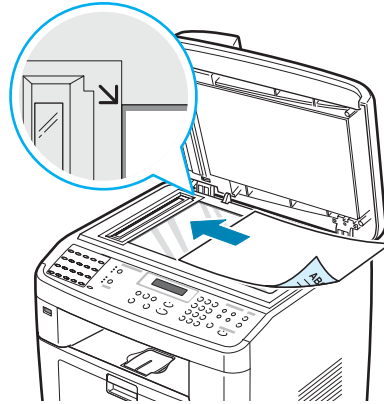

NOTE: Make sure that no other documents are in the ADF (Automatic Document Feeder). If a document is detected in the ADF, the machine gives it priority over the document on the document glass.

- 3 Close the document cover.



NOTES:

- If you are copying a page from a book or magazine, lift the cover until its hinges are caught by the stopper and then close the cover. If the book or magazine is thicker than 30 mm, start copying with the cover open.
 - To get the best scan quality, especially for colored or gray-scaled images, use the document glass.
-

Selecting the Paper Tray

After loading the print material for fax output, you have to select the paper tray you will use for the fax job.

- 1 Press **Menu** on the control panel.
The first available menu, item "Paper Setting," appears on the top line of the display.
- 2 Press the scroll button (◀ or ▶) until "Fax Tray" appears on the bottom line of the display.
- 3 Press **Enter**.
- 4 Press the scroll button (◀ or ▶) until the paper tray you want appears on the display.
You can select Tray1, Tray2, Tray1/2, or Auto. If you do not install the optional Tray 2, the Tray2 and Tray1/2 menu item will not appear on the display.
- 5 Press **Enter** to save the selection.
- 6 To return to Standby mode, press **Stop/Clear**.

Adjusting the Document Resolution

The default document settings produce good results when using typical text-based documents.

However, if you send documents that are of a poor quality, or contain photographs, you can adjust the resolution to produce a higher quality fax.

- 1 Press **Resolution** on the control panel.
- 2 By pressing **Resolution** or the scroll button (◀ or ▶), you can choose from Standard, Fine, Super Fine, Photo Fax, and Color Fax.
- 3 When the mode you want to use displays, press **Enter** to make your selection.

The document types recommended for the resolution settings are described in the table below:

Mode	Recommended for:
Standard	Documents with normal sized characters.
Fine	Documents containing small characters or thin lines or documents printed using a dot-matrix printer.
Super Fine	Documents containing extremely fine detail. Super Fine mode is enabled only if the machine with which you are communicating also supports the Super Fine resolution. See the notes below.
Photo Fax	Documents containing shades of gray or photographs.
Color Fax	Documents with colors. Sending a color fax is enabled only if the machine with which you are communicating supports color fax reception and you send the fax manually. In this mode, memory transmission is not available.



NOTES:

- For memory transmission, Super Fine mode is not available. The resolution setting is automatically changed to Fine.
- When your machine is set to Super Fine resolution and the fax machine with which you are communicating does not support Super Fine resolution, the machine transmits using the highest resolution mode supported by the other fax machine.

Sending a Fax Automatically

- 1** Load the document(s) face up into the ADF.
OR
Place a single document face down on the document glass.
For details about loading a document, see page 7.6.
- 2** Adjust the document resolution to suit your fax needs (see page 7.9).
If you need to change the darkness, see page 7.3.
- 3** Enter the remote fax phone number using the number keypad.
You can use one-touch keypad, speed dial, or group dial numbers. For details about storing a number, see "Automatic Dialing" on page 7.19.
- 4** Press **Start**.
- 5** When a document is placed on the document glass, the display shows "Another Page?" on the top line after the document is scanned into the memory. If you have the next page, remove the scanned page and place the next page on the glass and select "1.Yes." Repeat as necessary.
After all of the pages are scanned, select "2.No" when the display shows "Another Page?"
- 6** The number is dialed and then the machine begins sending the fax when the receiving fax machine is ready.



NOTE: When you want to cancel a fax job, press **Stop/Clear** at any time while sending.

Sending a Fax Manually

- 1 Load the document(s) face up into the ADF.
OR
Place a single document face down on the document glass.
For details about loading a document, see page 7.6.
- 2 Adjust the document resolution to suit your fax needs (see page 7.9).
If you need to change the darkness, see page 7.3.
- 3 Press **On Hook Dial**. You hear a dial tone.
- 4 Enter the receiving fax machine's number using the number keypad.
You can use one-touch keypad. For details about storing a number, see page 7.19.
- 5 When you hear a high-pitched fax signal from the remote fax machine, press **Start**.



NOTE: When you want to cancel a fax job, press **Stop/Clear** at any time while sending.

Redialing the Last Number

To redial the number you last called:

Press **Redial/Pause**.

When a document is loaded in the ADF (Automatic Document Feeder; see page 7.6), the machine automatically begins to send.

For a document placed on the document glass, the display asks if you want to load another page. Select "1.Yes" to add. Otherwise, select "2.No."

Confirming Transmission

When the last page of your document has been sent successfully, the machine beeps and returns to Standby mode.

When something goes wrong while sending your fax, an error message appears on the display. For a list of error messages and their meanings, see page 9.12.

If you receive an error message, press **Stop/Clear** to clear the message and try to send the document again.

You can set your machine to print a confirmation report automatically each time sending a fax is completed. For further details, see the MSG Confirm item on page 7.4.

Automatic Redialing

When the number you have dialed is busy or there is no answer when you send a fax, the machine automatically redials the number every three minutes, up to several times according to the factory default settings.

When the display shows "Retry Redial ?," press **Enter** to redial the number without waiting. To cancel the automatic redialing, press **Stop/Clear**.

To change the time interval between redials and the number of redial attempts. See page 7.3.

Receiving a Fax

About Receiving Modes

- In **Fax** mode, the machine answers an incoming fax call and immediately goes into the fax reception mode.
- In **Tel** mode, you can receive a fax by pressing **On Hook Dial** (you can hear a fax tone from the sending machine) and then pressing **Start** on the control panel of your machine. You can also pick up the handset of the extension phone and then press the remote receive code (see page 7.4).
- In **Ans/Fax** mode, the answering machine answers an incoming call, and the caller can leave a message on the answering machine. If the fax machine senses a fax tone on the line, the call automatically switches to Fax mode.
- In **DRPD** mode, you can receive a call using the Distinctive Ring Pattern Detection (DRPD) feature. "Distinctive Ring" is a telephone company service which enables a user to use a single telephone line to answer several different telephone numbers. For further details, see page 7.17.

When your machine's memory is full, the receiving mode automatically switches to Tel.

For details about changing the receiving mode, see page 7.3.



NOTES:

- To use the Ans/Fax mode, attach an answering machine to the EXT jack on the back of your machine.
 - If you do not want other people to view your received documents, you can use Secure Receiving mode. In this mode, all of the received faxes are stored in memory. For further details, see page 7.34.
-

Loading Paper for Receiving Faxes

The instructions for loading paper in the paper tray are the same whether you are printing, faxing, or copying, except that faxes can only be printed on Letter-, A4-, or Legal-sized paper. For details about loading paper and setting the paper size in the tray, see page 2.7 and page 2.20.

Receiving Automatically in Fax Mode

Your machine is preset to Fax mode at the factory.

When you receive a fax, the machine answers the call on a specified number of rings and automatically receives the fax.

To change the number of rings, see page 7.3.

If you want to adjust the ringer volume, see "Setting Sounds" on page 2.21.

Receiving Manually in Tel Mode

You can receive a fax call by picking up the handset of the extension phone and then pressing the remote receive code (see page 7.4), or press **On Hook Dial** (you can hear a fax tone from the sending machine) and then pressing **Start** on the control panel of your machine.

The machine begins receiving a fax and returns to Standby mode when the reception is completed.

Receiving Automatically in Ans/Fax Mode

To use this mode, you must attach an answering machine to the EXT jack on the back of your machine. See page 2.11.

If the caller leaves a message, the answering machine stores the message as it would normally. If your machine detects a fax tone on the line, it automatically starts to receive the fax.



NOTES:

- If you have set your machine to Ans/Fax mode and your answering machine is switched off, or no answering machine is connected to EXT jack, your machine automatically goes into Fax mode after a predefined number of rings.
 - If your answering machine has a 'user-selectable ring counter', set the machine to answer incoming calls within 1 ring.
 - If you are in Tel mode (manual reception) when the answering machine is connected to your machine, you must switch off the answering machine, or the outgoing message from the answering machine will interrupt your phone conversation.
-

Receiving Manually Using an Extension Telephone

This feature works best when you are using an extension telephone connected to the EXT jack on the back of your machine. You can receive a fax from someone you are talking to on the extension telephone without going to the fax machine.

When you receive a call on the extension phone and hear fax tones, press the keys ***9*** on the extension telephone. The machine receives the document.

Press the buttons slowly in sequence. If you still hear the fax tone from the remote machine, try pressing ***9*** once again.

9 is the remote receive code preset at the factory. The first and the last asterisks are fixed, but you can change the middle number to whatever you wish. For details about changing the code, see page 7.4

Receiving Faxes Using the DRPD Mode

“Distinctive Ring” is a telephone company service which enables a user to use a single telephone line to answer several different telephone numbers. The particular number someone uses to call you is identified by different ringing patterns, which consist of various combinations of long and short ringing sounds. This feature is often used by answering services who answer telephones for many different clients and need to know which number someone is calling in on to properly answer the phone.

Using the Distinctive Ring Pattern Detection feature, your fax machine can “learn” the ring pattern you designate to be answered by the fax machine. Unless you change it, this ringing pattern will continue to be recognized and answered as a fax call, and all other ringing patterns will be forwarded to the extension telephone or answering machine plugged into the EXT jack. You can easily suspend or change Distinctive Ring Pattern Detection at any time.

Before using the Distinctive Ring Pattern Detection option, Distinctive Ring service must be installed on your telephone line by the telephone company. To set up Distinctive Ring Pattern Detection, you will need another telephone line at your location, or someone available to dial your fax number from outside.

To set up the DRPD mode:

- 1** Press **Menu** until “Fax Setup” appears on the top line of the display.

The first available menu item, “Receive Mode,” displays on the bottom line.

- 2** Press the scroll button (◀ or ▶) until you see “DRPD Mode” on the bottom line and press **Enter**.

- 3** When “Set” displays on the bottom line, press **Enter**.

“Waiting Ring” appears on the display.

- 4** Call your fax number from another telephone. It is not necessary to place the call from a fax machine.

- 5** When your machine begins to ring, do not answer the call. The machine requires several rings to learn the pattern.

When the machine completes learning, the LCD displays “End DRPD Setup”.

If the DRPD setup fails, "DRPD Ring Error" appears. Press **Enter** when "DRPD Mode" displays and retry from step 3.

6 To return to Standby mode, press **Stop/Clear**.

When the DRPD feature is set up, the DRPD option is available in the Receive Mode menu. To receive faxes in the DRPD mode, you need to set the menu to **DRPD**; see page 7.5.



NOTES:

- DRPD must be set up again if you re-assign your fax number, or connect the machine to another telephone line.
 - After DRPD has been set up, call your fax number again to verify that the machine answers with a fax tone. Then have a call placed to a different number assigned to that same line to be sure the call is forwarded to the extension telephone or answering machine plugged into the EXT jack.
-

Receiving Faxes in the Memory

Since your machine is a multi-tasking device, it can receive faxes while you are making copies or printing. If you receive a fax while you are copying or printing, your machine stores incoming faxes in memory. Then, as soon as you finish copying or printing, the machine automatically prints the fax.

Automatic Dialing

One-touch Dialing

The 20 one-touch buttons on the control panel lets you store frequently-used fax numbers and dial a number automatically with the touch of a button.

Using the **Shift** button, you can store up to 40 fax numbers on the one-touch buttons.

Storing a Number for One-touch Dialing

- 1 Press and hold one of the one-touch dial buttons for about 2 seconds.

If you want to use one-touch dial buttons from 21 to 40, press **Shift** and hold down the one-touch dial button for about 2 seconds.

The display asks you to enter the fax number. "T" signifies that you are assigning a one-touch dial button.

If a number is already stored in the location you chose, the display shows the number to allow you to change it. To start over with another one-touch button, press **Stop/Clear**.

- 2 Enter the number you want to store using the number keypad and press **Enter**.

To insert a pause between numbers, press **Redial/Pause**. The symbol "-" appears on the display.

If you make a mistake while entering a number, press the ◀ button and re-enter the correct number.

- 3 To assign a name to the number, enter the name you want. For details about entering characters, see page 2.17.

If you do not want to assign a name, skip this step.

- 4 Press **Enter** when the name appears correctly or without entering a name.

- 5 To store more numbers, press a one-touch button and repeat steps 2 through 4.

OR

To return to Standby mode, press **Stop/Clear**.

Sending a Fax using a One-touch Number

- 1 Load the document(s) face up into the ADF.

OR

Place a single document face down on the document glass.

For details about loading a document, see page 7.6.

- 2 Adjust the document resolution to suit your fax needs (see page 7.9).

If you need to change the darkness, see page 7.3.

- 3 Press the one-touch button where you stored a number.

The document scans into memory.

- 4 The machine dials the fax number stored in the one-touch dial location and the document is sent when the receiving fax machine answers.

Speed Dialing

You can store up to 200 frequently dialed numbers in one, two, or three-digit speed dial locations (0-199).

Storing a Number for Speed Dialing

- 1 Press **Phone Book** on the control panel.
- 2 Press **Phone Book** or the scroll button (◀ or ▶) to display "Store&Edit" on the bottom line of the display. Press **Enter**.
- 3 Press **Enter** when "Speed Dials" appears on the display.

The display prompts you to enter a location number, showing the first available number.

- 4 Enter a speed dial number between 0 and 199, using the number keypad or the scroll button (◀ or ▶) and press **Enter**.

If a number is already stored in the location you chose, the display shows the number to allow you to change it. To start over with another speed-dial number, press **Upper Level**.

- 5 Enter the number you want to store using the number keypad and press **Enter**.

To insert a pause between numbers, press **Redial/Pause**. The symbol "-" appears on the display.

- 6 To assign a name to the number, enter the name you want. For details about entering characters, see page 2.17.

OR

If you do not want to assign a name, skip this step.

- 7 Press **Enter** when the name appears correctly or without entering a name.

- 8 To store more fax numbers, repeat steps 4 through 7.

OR

To return to Standby mode, press **Stop/Clear**.

Sending a Fax using a Speed Dial Number

1 Feed the document(s) face up into the ADF.

Or

Place a single document face down on the document glass.

For details about loading a document, see page 7.6.

2 Adjust the document resolution to suit your fax needs (see page 7.9).

If you need to change the darkness, see page 7.3.

3 Enter the speed dial number.

- For a one-digit speed dial number, press and hold the appropriate digit button.
- For a two or three-digit speed dial number, press the first digit button(s) and press and hold the last digit button.

4 The corresponding entry's name briefly displays.

5 The document scans into memory.

When a document is placed on the document glass, the LCD display asks if you want to send another page. Select "1.Yes" to add more documents or "2.No" to begin sending the fax immediately.

6 The fax number stored in the speed dial location is automatically dialed. The document is sent when the receiving fax machine answers.

Group Dialing

If you frequently send the same document to several destinations, you can create a group of these destinations and set them under a group dial location. This enables you to use a group dial number setting to send the same document to all the destinations in the group.

Setting a Group Dial Number

- 1 Press **Phone Book** on the control panel.
- 2 Press **Phone Book** or the scroll button (◀ or ▶) to display "Store&Edit" on the bottom line of the display. Press **Enter**.
- 3 Press the scroll button (◀ or ▶) to display "Group Dials" on the bottom line and press **Enter**.
- 4 Press **Enter** when "New" displays on the bottom line.
The display prompts you to enter a location number, showing the first available number.
- 5 Enter a group number between 0 and 199 using the number keypad or the scroll button (◀ or ▶) and press **Enter**.
- 6 Press a one-touch dial button or enter a speed dial number you want to include in the group and press **Enter**.
You can also select the one-touch dial button or speed dial number stored in the machine by pressing the scroll button (◀ or ▶) and then press **Enter**.
- 7 When the display confirms the number to be added to the group, press **Enter**.
- 8 Repeat steps 6 and 7 to enter other one-touch dial or speed dial numbers into the group.
- 9 Press the **Upper Level** button when you have entered all of the desired numbers. The display prompts you to enter a group ID.
- 10 To assign a name to the group, enter the name you want. For details about entering characters, see page 2.17.

OR

If you do not want to assign a name, skip this step.

11 Press **Enter** when the name appears correctly or without entering a name.

12 If you want to assign another group, press **Enter** and repeat from step 5.

OR

To return to Standby mode, press **Stop/Clear**.



NOTE: You cannot include one group dial number in another group dial number.

Editing Group Dial Numbers

You can delete a specific speed dial number from a selected group or add a new number to the selected group.

- 1** Press **Phone Book** on the control panel.
- 2** Press **Phone Book** or the scroll button (◀ or ▶) to display "Store&Edit" on the bottom line of the display. Press **Enter**.
- 3** Press the scroll button (◀ or ▶) to display "Group Dials" on the bottom line and press **Enter**.
- 4** Press the scroll button (◀ or ▶) to display "Edit" on the bottom line and press **Enter**.
- 5** Enter the group number you want to edit or select the group number by pressing the scroll button (◀ or ▶) and press **Enter**.
- 6** Press a one-touch dial button or enter the speed dial number you want to add or delete.

You can also select the one-touch dial number or speed dial number you want to delete by pressing the scroll button (◀ or ▶).

- 7** Press **Enter**.
- 8** When you enter the specific number in the group, the display shows "Delete?."

When you enter a new number, the display shows "Add?."

9 Press **Enter** to add or delete the number.

10 To change the group name, press **Upper Level**.

11 Enter a new group name and press **Enter**.

12 If you want to edit another group, press **Enter** and repeat from step 5.

Or

To return to Standby mode, press **Stop/Clear**.

Sending a Fax Using Group Dialing (Multi-address Transmission)

You can use group dialing for Broadcast or Delayed transmissions.

Follow the procedure of the operation (Broadcast fax: see page 7.28, Delayed fax: see page 7.29, Priority fax: see page 7.31). When you come to a step in which the display asks you to enter the receiving fax number:

- For a one-digit group number, press and hold the appropriate digit button.
- For a two or three-digit group number, press the first digit button(s) and press and hold the last digit button.

You can use only one group number for one operation. Then continue the procedure to complete the desired operation.

Your machine automatically scans a document loaded in the Automatic Document Feeder or on the document glass into memory. The machine dials each of the numbers included in the group.

Searching for a Number in Memory

There are two ways to search for a number in the machine's memory. You can either scan from A to Z sequentially, or you can search using the first letter of the name associated with the number.

Searching Sequentially through the Memory

- 1 Press **Phone Book**.
- 2 Press **Enter** when "Search&Dial" appears on the display.
- 3 Press the scroll button (◀ or ▶) to scroll through the machine's memory until the name and number you want to dial display. You can search upwards or downwards through the entire memory in alphabetical order, from A to Z.

While searching through the machine's memory, you can see that each entry is preceded by one of three letters; "T" for one-touch dial, "S" for speed dial or "G" for group dial numbers. These letters tell you how the number is stored.

- 4 When the name and/or the number you want displays, press **Start** or **Enter** to dial.

Searching with a Particular First Letter

- 1 Press **Phone Book**.
- 2 Press **Enter** when "Search&Dial" appears on the display.
- 3 Press the button labeled with the letter you want to search for. A name beginning with the letter displays.

For example, if you want to find the name "MOBILE" press the **6** button, which is labeled with "MNO."

- 4 Press the scroll button (◀ or ▶) to display the next name.
- 5 When the name and/or the number you want displays, press **Start** or **Enter** to dial.

Printing a Phonebook List

You can check your automatic dial setting by printing a Phonebook list.

- 1 Press **Phone Book**.
- 2 Press **Phone Book** or the scroll button (◀ or ▶) until "Print" appears on the bottom line and press **Enter**.

A list showing your one-touch dial, speed dial, and group dial entries prints out.

Other Ways to Fax

Sending Broadcast Faxes

Using the **Broadcasting** button on the control panel, you can use the broadcast fax feature, which allows you to send a document to multiple locations. Documents are automatically stored in memory and sent to a remote station. After transmission, the documents are automatically erased from memory.

- 1** Load the document(s) face up into the ADF.
OR
Place a single document face down on the document glass.
For details about loading a document, see page 7.6.
- 2** Adjust the document resolution to suit your fax needs (see page 7.9).
If you need to change the darkness, see page 7.3.
- 3** Press **Broadcasting** on the control panel.
- 4** Enter the number of the first receiving machine using the number keypad.
You can use one-touch keypad, speed dial, or group dial numbers. For details, see "Automatic Dialing" on page 7.19.
- 5** Press **Enter** to confirm the number. The display asks you to enter another fax number to send the document.



NOTE: The Another No. prompt does not appear if you have added numbers for another broadcast or delay fax job. You must wait until the job is completed.

- 6** To enter more fax numbers, press **1** to select "Yes" and repeat steps 4 and 5. You can add up to 10 destinations.
Note that you can input group dial numbers only once at first.

- 7 When you finish entering fax numbers, press **2** to select "No" at the Another No. prompt.

The document is scanned into memory before transmission. The display shows memory capacity and the number of pages being stored in memory.

For a document placed on the document glass, the display asks if you want to load another page. Select "1.Yes" to add. Otherwise, select "2.No."

- 8 The machine begins sending the document to the numbers you entered in the order in which you entered them.

Sending a Delayed Fax

You can set your machine to send a fax at a later time when you will not be present.

- 1 Load the document(s) face up into the ADF.

OR

Place a single document face down on the document glass.

For details about loading a document, see page 7.6.

- 2 Adjust the document resolution to suit your fax needs (see page 7.9).

If you need to change the darkness, see page 7.3.

- 3 Press **Menu** until "Fax Feature" appears on the top line of the display. The first available menu item, "DelayFax" displays on the bottom line.

- 4 Press **Enter**.

- 5 Enter the number of the receiving machine using the number keypad.

You can use one-touch keypad, speed dial, or group dial numbers. For details, see "Automatic Dialing" on page 7.19.

- 6 Press **Enter** to confirm the number on the display. The display asks you to enter another fax number to which to send the document.



NOTE: The Another No. prompt does not appear if you have added numbers for another broadcast or delay fax job. You must wait until the job is completed.

- 7** To enter more fax numbers, press **1** to select "Yes" and repeat steps 5 and 6. You can add up to 10 destinations.

Note that you can input group dial numbers only once at first.
- 8** When you finish entering fax numbers, press **2** to select "No" at the Another No. prompt.

The display asks you to enter a name.
- 9** To assign a name to the transmission, enter the name you want. For details about entering characters, see page 2.17.

If you do not want to assign a name, skip this step.
- 10** Press **Enter**. The display shows the current time and asks you to enter the starting time when the fax is to be sent.
- 11** Enter the time using the number keypad.

To select "AM" or "PM" for 12-hour format, press the * or # button or any number button.

If you set a time earlier than the current time, the document will be sent at that time on the following day.
- 12** Press **Enter** when the starting time displays correctly.
- 13** The document is scanned into memory before transmission. The display shows memory capacity and the number of pages being stored in memory.

For a document placed on the document glass, the display asks if you want to load another page. Select "1.Yes" to add. Otherwise, select "2.No."
- 14** The machine returns to Standby mode. The display reminds you that you are in Standby mode and that a delayed fax is set.



NOTE: If you want to cancel the delayed transmission, see "Canceling a Scheduled Fax" on page 7.33.

Sending a Priority Fax

Using the Priority Fax feature, a high priority document can be sent ahead of reserved operations. The document is scanned into memory and transmitted when the current operation is finished. In addition, priority transmission will interrupt a broadcast operation between stations (i.e., when the transmission to station A ends, before transmission to station B begins) or between redial attempts.

- 1** Load the document(s) face up into the ADF.
OR
Place a single document face down on the document glass.
For details about loading a document, see page 7.6.
- 2** Adjust the document resolution to suit your fax needs (see page 7.9).
If you need to change the darkness, see page 7.3.
- 3** Press **Menu** until "Fax Feature" appears on the top line of the display.
- 4** Press the scroll button (◀ or ▶) to display "Priority Fax" on the bottom line and press **Enter**.
- 5** Enter the number of the receiving machine using the number keypad.
To enter the number, you can use one-touch keypad, speed dial, or group dial numbers. For details, see "Automatic Dialing" on page 7.19.
- 6** Press **Enter** to confirm the number. The display asks you to enter a name.
- 7** To assign a name to the transmission, enter the name you want. For details about entering characters, see page 2.17.
If you do not want to assign a name, skip this step.
- 8** Press **Enter**.
The document is scanned into memory before transmission. The display shows memory capacity and the number of pages being stored in memory.

For a document placed on the document glass, the display asks if you want to load another page. Select "1.Yes" to add. Otherwise, select "2.No."

- 9 The machine shows the number being dialed and begins sending the document.

Adding Documents To a Scheduled Fax

You can add documents to a delayed transmission previously reserved in your machine's memory.

- 1 Load the document(s) face up into the ADF.

OR

Place a single document face down on the document glass.

For details about loading a document, see page 7.6.

- 2 Adjust the document resolution to suit your fax needs (see page 7.9).

If you need to change the darkness, see page 7.3.

- 3 Press **Menu** until "Fax Feature" appears on the top line of the display.

- 4 Press the scroll button (◀ or ▶) to display "Add Page" on the bottom line and press **Enter**.

The display shows the last job reserved in memory.

- 5 Press the scroll button (◀ or ▶) until you see the fax job to which you want to add documents and press **Enter**.

The machine automatically stores the documents in memory, and the display shows memory capacity and the number of pages.

For a document placed on the document glass, the display asks if you want to load another page. Select "1.Yes" to add. Otherwise, select "2.No."

- 6 After storing, the machine displays the numbers of total pages and added pages and then returns to Standby mode.

Canceling a Scheduled Fax

- 1** Press **Menu** until "Fax Feature" appears on the top line of the display.
- 2** Press the scroll button (◀ or ▶) to display "Cancel Job" on the bottom line and press **Enter**.
The display shows the last job reserved in memory.
- 3** Press the scroll button (◀ or ▶) until you see the fax job you want to cancel, and press **Enter**.
- 4** When the display confirms your selection, press **1** to select "Yes." The selected job is canceled and the machine returns to Standby mode.

To cancel your selection, press **2** to select "No."

Additional Features

Using Secure Receiving Mode

You may need to prevent your received faxes from being accessed by unauthorized people. You can turn on Secure Receiving mode to restrict printing of received faxes when the machine is unattended. In Secure Receiving mode, all incoming faxes go into memory. When the mode is deactivated, any stored faxes are printed.

To turn Secure Receiving mode on:

- 1** Press **Menu** until "Advanced Fax" appears on the top line of the display.
- 2** Press the scroll button (◀ or ▶) until "Secure Receive" appears on the bottom line and press **Enter**.
- 3** Press the scroll button (◀ or ▶) to display "On" on the bottom line and press **Enter**.
- 4** Enter a four-digit passcode you want to use, using the number keypad and press **Enter**.



NOTE: You can activate Secure Receiving mode without setting a passcode, but cannot protect your faxes.

- 5** Re-enter the passcode to confirm it and press **Enter**.
- 6** To return to Standby mode, press **Stop/Clear**.

When a fax is received in Secure Receiving mode, your machine stores it in memory and displays "Secure Receive" to let you know that there is a fax stored.

To print received documents:

- 1** Access the Secure Receive menu by following steps 1 and 2 on page 7.34.

2 Press the scroll button (◀ or ▶) to display "Print" on the bottom line and press **Enter**.

3 Enter the four-digit passcode and press **Enter**.

The machine prints all of the faxes stored in memory.

To turn Secure Receiving mode off:

1 Access the Secure Receive menu by following steps 1 and 2 on page 7.34.

2 Press the scroll button (◀ or ▶) to display "Off" on the bottom line and press **Enter**.

3 Enter the four-digit passcode and press **Enter**.

The mode is deactivated and the machine prints all faxes stored in memory.

4 To return to Standby mode, press **Stop/Clear**.

Printing Reports

Your machine can print reports containing useful information. The following reports are available:

Phonebook List

This list shows all of the numbers currently stored in the machine's memory as speed dial and group dial numbers.

You can print this Phonebook list using the **Phone Book** button: see page 7.27.

Sent Fax Report

This report shows information on the faxes you have recently sent.

Received Fax Report

This report shows information on the faxes you have recently received.

System Data List

This list shows the status of the user-selectable options. You may print this list to confirm your changes after changing any settings.

Scheduled Job Information

This list shows the document(s) currently stored for Delayed faxes or Toll Save faxes. The list shows the starting time(s) and type(s) of operation(s).

Message Confirmation

This report shows the fax number, the number of pages, the elapsed time of the job, the communication mode, and the communication results for a particular fax job.

You can set up your machine to automatically print a message confirmation report after each fax job. See page 7.4.

Junk Fax Number List

This list shows up to 10 fax numbers specified as junk fax numbers. To add or delete numbers to or from this list, access the Junk Fax Setup menu: see page 7.39. When the Junk Fax Barrier feature is turned on, incoming faxes from those numbers are blocked.

This feature recognize the last 6 digits of the fax number set as a remote fax machine's ID.

Multi-communication Report

This report is printed automatically after sending documents from more than one location.

Power Failure Report

This report is printed out automatically when power is restored after a power failure, if any data loss occurs due to the power failure.



NOTE: The lists you have set to print out automatically don't print out when there is no paper loaded or a paper jam has occurred.

Scan Journal

This list shows information for the Network Scan records including IP address, time & date, the number of pages scanned, and result. This report is automatically printed when the report contains the 50 jobs and the records that are printed will be deleted.

Printing a Report

- 1 Press **Menu** until "Report" appears on the top line of the display. The first available menu item, "Phone Book," displays on the bottom line.
- 2 Press the scroll button (◀ or ▶) to display the report or list you want to print on the bottom line.
 - Phone Book: Phonebook list
 - Sent Report: Sent fax report
 - RCV Report: Received fax report
 - System Data: System data list
 - Scheduled Jobs: Scheduled job information
 - MSG Confirm: Message confirmation
 - Junk Fax List: Junk fax number list
 - Scan Journal: Network Scan sessions list
- 3 Press **Enter**.

The selected information prints out.

Using Advanced Fax Settings

Your machine has various user-selectable setting options for sending or receiving faxes. These options are preset at the factory, but you may need to change them. To find out how the options are currently set, print the System Data list. For details about printing the list, see above.

Changing Setting Options

- 1 Press **Menu** until "Advanced Fax" appears on the top line of the display. The first available menu item, "Send Forward," displays on the bottom line.
- 2 Press the scroll button (◀ or ▶) until you see the menu item you want on the bottom line and press **Enter**.
- 3 When the option you want appears on the display, choose a status by pressing the scroll button (◀ or ▶) or enter a value using the number keypad.
- 4 Press **Enter** to save the selection.

- 5 You can exit from Setup mode at any time by pressing **Stop/Clear**.

Advanced Fax Setting Options

Option	Description
Send Forward	<p>You can set the machine to send a copy of all outgoing faxes to a specified destination, in addition to the fax numbers you entered.</p> <p>Select Off to turn this feature off. Select On to turn this feature on. You can set the number of the fax machine to which faxes are to be sent.</p>
RCV Forward	<p>You can set your machine to forward incoming faxes to another fax number during a specified time period. When a fax arrives at your machine, it is stored in memory. Then, the machine dials the fax number that you have specified and sends the fax.</p> <p>Select Off to turn this feature off. Select On to turn this feature on. You can set the fax number to which faxes are forwarded. Then, you can enter the starting time and date, and/or the ending time and date. The Local Copy option allows you to set the machine to print the fax on your machine, if fax forwarding is completed without any error.</p>
Toll Save	<p>You can set your machine to store your faxes in memory and send them at a specified toll-saving time. For details about Toll Save mode, see page 2.23.</p> <p>Select Off to turn this feature off. Select On to turn this feature on. You can set the starting time and date, and/or the ending time and date for Toll Save mode.</p>

Option	Description
Junk Fax Setup	<p>Using the Junk Fax Barrier feature, the system will not accept faxes sent from remote stations whose numbers are stored in the memory as junk fax numbers. This feature is useful for blocking any unwanted faxes.</p> <p>Select Off to turn the feature off. Your machine accepts all faxes.</p> <p>Select On to turn the feature on. You can set up to 10 fax numbers as junk fax numbers using the Set option. After storing numbers, your machine will not accept faxes from the registered stations. To delete all junk fax numbers, use the All Delete option.</p>
Secure Receive	<p>You can keep your received faxes from being accessed by unauthorized people.</p> <p>For further details about setting this mode, see page 7.34.</p>
Prefix Dial	<p>You can set a prefix dial number of up to five digits. This number dials before any automatic dial number is started. It is useful for accessing a PABX exchange.</p>
Stamp RCV Name	<p>This option allows the machine to automatically print the page number, and the date and time of reception at the bottom of each page of a received document.</p> <p>Select Off to turn this feature off.</p> <p>Select On to turn this feature on.</p>
ECM Mode (Error Correction Mode)	<p>Error Correction Mode helps with poor line quality and makes sure any faxes you send are sent smoothly to any other ECM-equipped fax machine. If the line quality is poor, it takes more time to send a fax when you are using ECM.</p> <p>Select Off to turn this feature off.</p> <p>Select On to turn this feature on.</p>

MEMO



8

MAINTENANCE

This chapter provides information for maintaining your machine and the toner cartridge.

This chapter includes:

- **Clearing the Memory**
- **Cleaning Your Machine**
- **Maintaining the Toner Cartridge**
- **Consumables and Replacement Parts**
- **Replacing the ADF Rubber Pad**
- **Setting E-mail Notification**

Clearing the Memory

You can selectively clear information stored in your machine's memory.



CAUTION: Before clearing the memory, make sure that all fax jobs have been completed.

1 Press **Menu** on the control panel until "Maintenance" appears on the top line of the display.

2 Press the scroll button (◀ or ▶) until you see "Clear Settings" on the bottom line and press **Enter**.

The first available menu item, "All Settings," displays on the bottom line.

3 Press the scroll button (◀ or ▶) until you see the item you want to clear.

- All Settings: Clears all of the data stored in the memory and resets all of your settings to the factory default.
- Paper Setting: Restores all of the Paper Setting options to the factory default.
- Copy Setup: Restores all of the Copy Setup options to the factory default.
- Fax Setup: Restores all of the Fax Setup options to the factory default.
- Fax Feature: Cancels all of the scheduled fax jobs in the machine's memory.
- Advanced Fax: Restores all of the Advanced Fax setting options to the factory default.
- Sent Report: Clears all records of sent faxes.
- RCV Report: Clears all records of received faxes.
- Phone Book: Clears the one-touch, speed dial, and group dial numbers stored in the memory.
- Scan Journal: Clears the information on Network Scan sessions in the memory.

4 Press **Enter**. The selected memory is cleared and the display asks you to continue clearing the next item.

5 To clear another item, repeat steps 3 and 4.

OR

To return to Standby mode, press **Stop/Clear**.

Cleaning Your Machine

To maintain print quality, follow the cleaning procedures below each time the toner cartridge is replaced or if print quality problems occur.



CAUTIONS:

- Cleaning the cabinet of the machine with cleaning materials containing large amounts of alcohol, solvent, or other strong substances can discolor or crack the cabinet.
 - While cleaning the inside of the machine, be careful not to touch the transfer roller, located underneath the toner cartridge. Oil from your fingers can cause print quality problems.
-

Cleaning the Outside

Clean the cabinet of the machine with a soft lint-free cloth. You can dampen the cloth slightly with water, but be careful not to let any water drip onto or into the machine.

Cleaning the Inside

During the printing process, paper, toner, and dust particles can accumulate inside the machine. This buildup can cause print quality problems, such as toner specks or smearing. Cleaning the inside of the machine clears or reduces these problems.

- 1 Turn the machine off and unplug the power cord. Wait for the machine to cool down.
- 2 Open the front door and pull the toner cartridge out, lightly pushing it down. Set it on a clean flat surface.

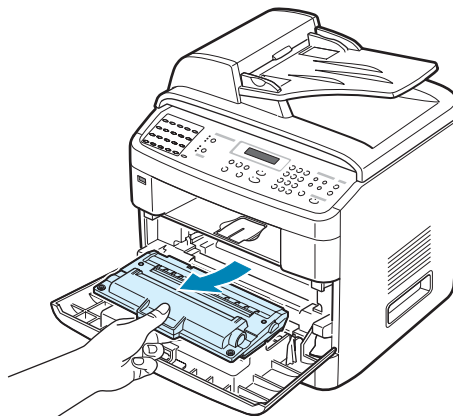



CAUTIONS:

- To prevent damage to the toner cartridge, do not expose it to light for more than a few minutes. Cover it with a piece of paper, if necessary.
 - Do not touch the green underside of the toner cartridge. Use the handle on the cartridge to avoid touching this area.
-

- 3** With a dry lint-free cloth, wipe away any dust and spilled toner from the toner cartridge area and the toner cartridge cavity.

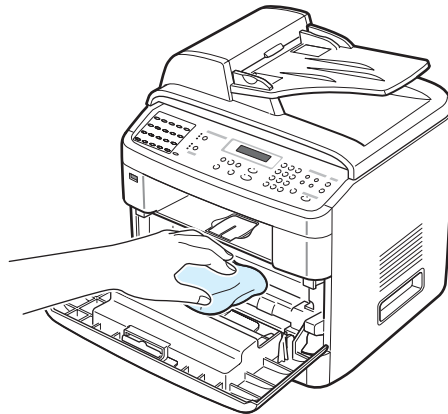

CAUTION: Do not touch the black transfer roller inside the machine.

- 4** Locate the long strip of glass (LSU) inside the top of the cartridge compartment, and gently swab the glass to see if dirt turns the white cotton black.

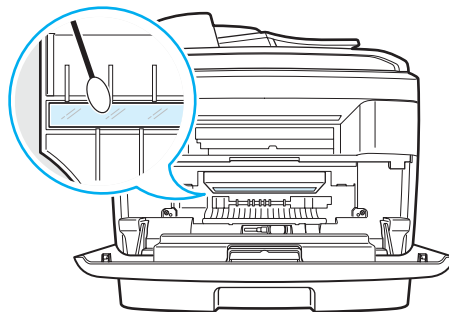

- 5** Reinsert the toner cartridge and close the door.
- 6** Plug in the power cord and turn the machine on.

Cleaning the Scan Unit

Keeping the scan unit clean helps ensure the best possible copies. We suggest that you clean the scan unit at the start of each day and during the day, as needed.

- 1** Slightly dampen a soft lint-free cloth or paper towel with water.
- 2** Open the document cover.
- 3** Wipe the surface of the document glass and ADF glass until it is clean and dry.

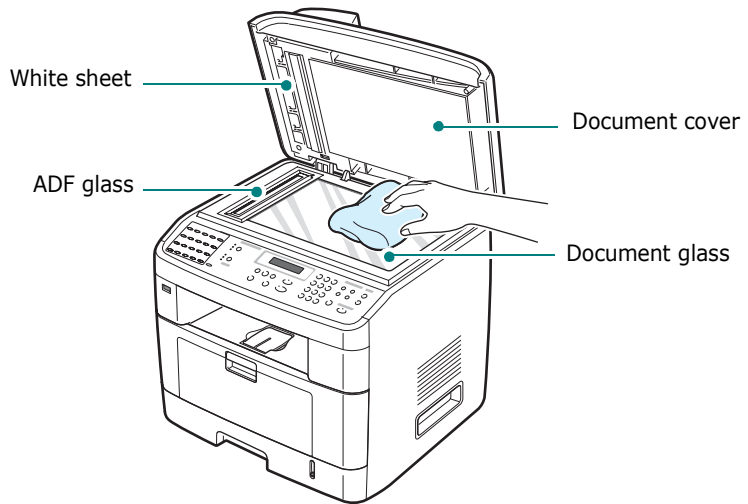

- 4** Wipe the underside of the white document cover and white sheet until it is clean and dry.
- 5** Close the document cover.

Maintaining the Toner Cartridge

Toner cartridge storage

To get the most from the toner cartridge, keep the following guidelines in mind:

- Do not remove the toner cartridge from its package until ready for use.
- Do not refill the toner cartridge. **The machine warranty does not cover damage caused by using a refilled cartridge.**
- Store toner cartridges in the same environment as your machine.
- To prevent damage to the toner cartridge, do not expose it to light for more than a few minutes.

Saving toner

To save toner, press the **Toner Save** button on the control panel; see page 2.23. The button backlight turns on. Using this feature extends the life of the toner cartridge and reduces your cost per page, but it also reduces print quality.

Expected Cartridge Life

The life of the toner cartridge depends on the amount of toner that print jobs require. When printing text at ISO 19752 5% coverage, a new toner cartridge lasts an average of 5,000 or 3,000 pages. (The original toner cartridge supplied with the machine lasts an average of 3,000 pages.) The actual number may be different depending on the print density of the page you print. If you print a lot of graphics, you may need to change the cartridge more often.

Redistributing Toner

When the toner cartridge is near the end of its life, white streaks or light printing occurs. The LCD displays the warning message, "Toner Low." You can temporarily reestablish print quality by redistributing the remaining toner in the cartridge. In some case, white streaks or light printing still occurs even after you have redistributed the toner.

- 1 Open the front door.

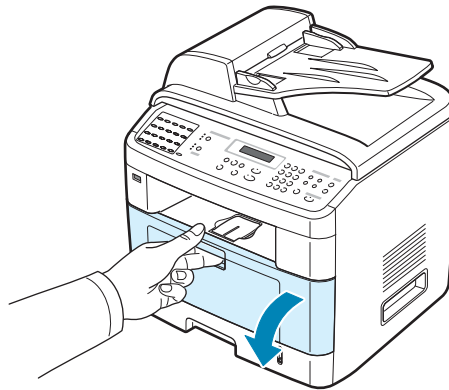

- 2 Pull the toner cartridge out and gently roll the cartridge 5 or 6 times to distribute the toner evenly inside the cartridge.

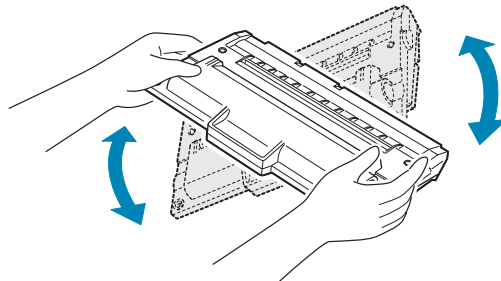

NOTE: If toner gets on your clothing, wipe it off with a dry cloth and wash clothing in cold water. Hot water sets toner into fabric.



CAUTION: Do not touch the green underside of the toner cartridge. Use the handle on the cartridge to avoid touching this area.

- 3 Reinstall the cartridge and close the front door.

Replacing the Toner Cartridge

When the display on the control panel shows the warning message, "Toner Empty" or "[Toner Empty] Replace Toner," the machine stops printing. The incoming faxes are saved in memory. At this stage, the toner cartridges need to be replaced.



NOTE: You can set the machine to ignore the "Toner Empty" message and to continue printing.

- 1 Open the front door.

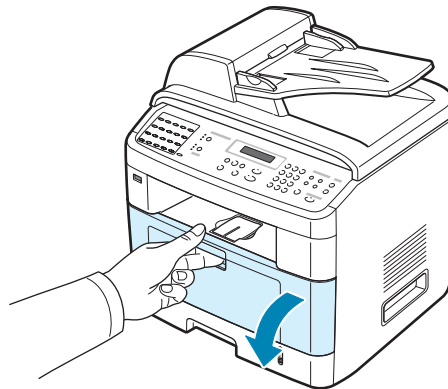

- 2 Lightly pushing the used cartridge down, pull it out.

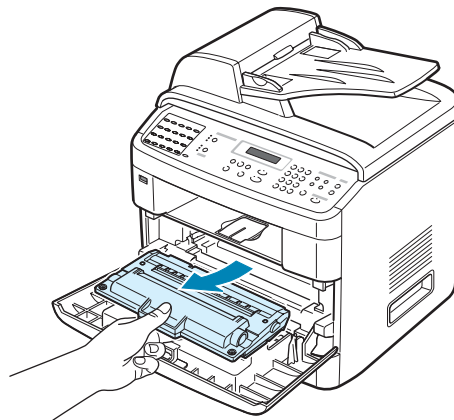

- 3 Unpack the new toner cartridge and gently roll it horizontally 5 or 6 times to distribute the toner evenly inside the cartridge.

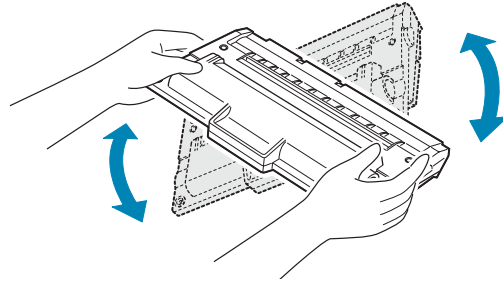

Save the box and the plastic bag for shipping.



NOTE: If toner gets on your clothing, wipe it off with a dry cloth and wash clothing in cold water. Hot water sets toner into fabric.



CAUTION: Do not touch the green underside of the toner cartridge. Use the handle on the cartridge to avoid touching this area.

- 4 Hold the toner cartridge by the handle. Slowly insert the cartridge into the opening in the machine. Tabs on the sides of the cartridge and corresponding grooves within the machine will guide the cartridge into the correct position until it locks into place completely.

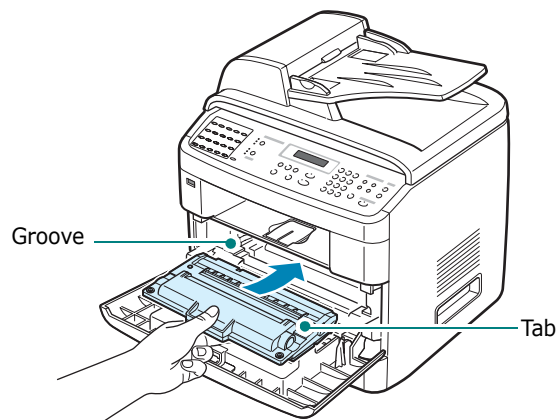

- 5 Close the front door.

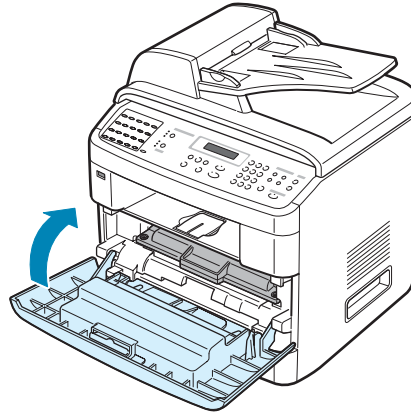

Setting the Notify Toner Option

If you set the Notify Toner menu option to "On," your machine automatically sends a fax to your service company or the dealer to notify them that your machine requires a new toner cartridge when the toner cartridge needs to be replaced. The fax number is preset by your dealer when you bought your machine.

- 1 Press **Menu** on the control panel until "Maintenance" appears on the top line of the display.
The first available menu item, "Clean Drum," displays on the bottom line.
- 2 Press the scroll button (◀ or ▶) to display "Notify Toner " on the bottom line and press **Enter**.
- 3 Press the scroll button (◀ or ▶) to change the setting.
Select "On" to enable this feature. Selecting "Off" disables this feature.
- 4 Press **Enter** to save the selection.

Cleaning the Drum

If there are streaks or spots on your print, the OPC drum of the toner cartridge may require cleaning.

- 1 Before starting the cleaning procedure, make sure that paper is loaded in the machine.

- 2 Press **Menu** on the control panel until "Maintenance" appears on the top line of the display.

The first available menu item, "Clean Drum," displays on the bottom line.

- 3 Press **Enter**.

The first available menu item, "Yes" displays on the bottom line.

- 4 Press **Enter**.

The machine prints out a cleaning page. Toner particles on the drum surface are affixed to the paper.

- 5 If the problem remains, repeat steps 1 through 4.

You can set your machine to clean the OPC drum automatically every 500 print pages. You should use this feature if you use inferior quality paper, because such paper may lower print quality.

- 1 Press **Menu** on the control panel until "Maintenance" appears on the top line of the display.

- 2 Press the scroll button (◀ or ▶) until "Auto Cleaning" appears on the bottom line and press **Enter**.

- 3 Press the scroll button (◀ or ▶) until "On" appears on the display.



NOTE: For users in Asian countries, this feature is preset to "On."

- 4 Press **Enter**.

The machine will print out an OPC cleaning page every 500 print pages.

Ignoring the Toner Empty Message

When the toner cartridge is nearly empty, the machine shows the "Toner Empty" or "[Toner Empty] Replace Toner" message and stops printing. In this case, this machine saves incoming faxes in memory.

You can set the machine to ignore the "Toner Empty" message when it displays and to continue printing, even though print quality is not optimal.



NOTE: This feature does not work for the "[Toner Empty] Replace Toner" message.

- 1** Press **Menu** until "Machine Setup" appears on the display.
- 2** Press the scroll button (◀ or ▶) until "Ignore Toner" appears on the bottom line and press **Enter**.
- 3** Press the Scroll button (◀ or ▶) to select "On" or "Off".
Select "On" to ignore the Toner Empty message.
Select "Off" to stop printing when the message appears.
This is the default setting.
- 4** Press **Enter** to save the selection.

Consumables and Replacement Parts

From time to time, you need to replace the toner cartridge, roller, and fuser unit to maintain top performance and to avoid print quality problems and paper feed problems resulting from worn parts.

The following items should be replaced after you have printed the specified number of pages:

Items	Yield (Average)
ADF rubber pad	Approx. 20,000 pages
Transfer roller	Approx. 60,000 pages
Fuser unit	Approx. 80,000 pages

To purchase consumables and replacement parts, contact your Samsung dealer or the retailer where you bought your machine. We strongly recommend that these items be installed by a trained service professional, except for the toner cartridge (see page 8.8) and the ADF rubber pad (see page 8.14).

Replacing the ADF Rubber Pad

You can purchase an ADF rubber pad from your Samsung dealer or the retailer where you bought your machine.

- 1 Open the ADF cover.

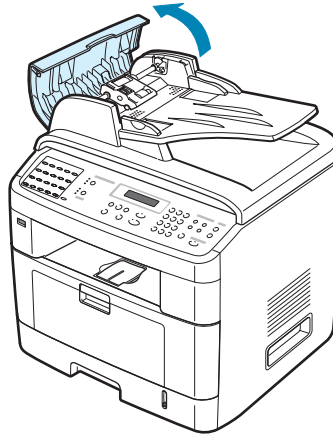

- 2 Rotate the bushing on the right end of the ADF roller toward the ADF(①) and remove the roller from the slot(②).

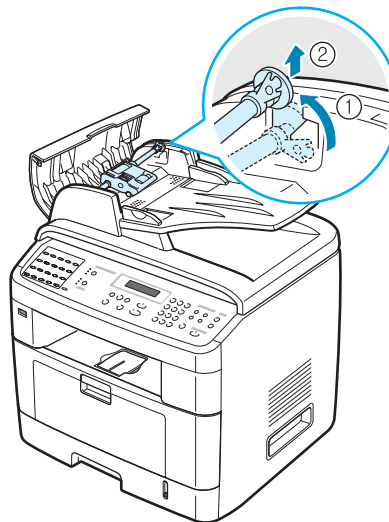

- 3 Remove the ADF rubber pad from the ADF, as shown.

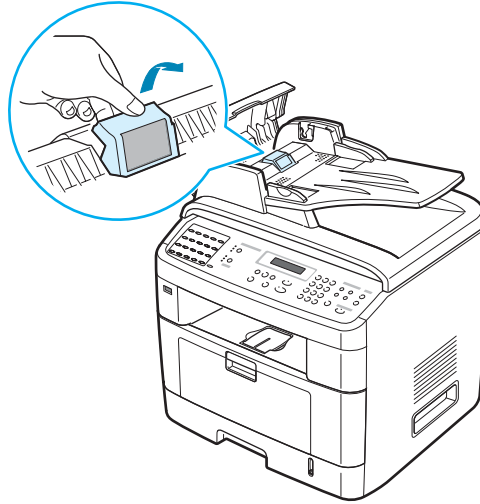

- 4 Insert a new ADF rubber pad into place.
- 5 Align the left end of the ADF roller with the slot and push the right end of the ADF roller into the right slot (①). Rotate the bushing on the right end of the roller toward the document input tray (②).

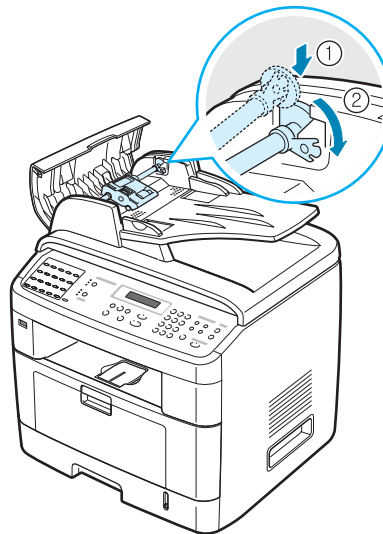

- 6 Close the ADF cover.

Setting E-mail Notification

This feature allows you to know your machine's status through your e-mail. To set E-mail Notification, you need to enter some information in the SyncThru Web Service.

In the Web Browser address bar, enter your machine's IP address you assigned. Then the SyncThru Web Service opens. It is consist of the Information, Machine Setup, Network Settings, Maintenance and support tabs.

Setting the Machine Setup tab

Select the **Machine Setup** tab and then configure the E-mail Notification option.

You may see the following window.

The screenshot shows the 'E-mail Notification Setup' page in the SyncThru Web Service. The page has a navigation bar with tabs: Home, Information, Machine Settings (selected), Network Settings, Maintenance, and Support. On the left, there is a sidebar with 'Machine Settings' expanded to show 'E-mail Notification Setup' selected. Below this are options for 'General Setup', 'Tray Setup', 'Printer Setup', 'Copy Setup', 'Fax Setup', 'Reset', and 'Select Language' (set to English). The main content area is titled '> E-mail Notification Setup >>' and contains the following fields:

- Server Information:** Radio buttons for 'IP Address' and 'Host Name'.
- IP Address or Host Name:** A text input field.
- SMTP Server and Port:** A text input field with a dropdown menu showing '25' and a range '(1-65535)'. The '25' is highlighted.
- SMTP Requires Authentication:** A checkbox.
- SMTP Server Login Name:** A text input field.
- SMTP Server Password:** A text input field.
- SMTP Server Connection Timeout:** A text input field with a dropdown menu showing '30' and a range '(30-120) second(s)'. The '30' is highlighted.
- Reply Address:** A text input field.
- Note:** 'If you want to receive the reply to other mail account, please type it. If blank, this will not be used.'
- Recipient list & Conditions:** A section with two text input fields: 'SysAdmin E-mail Address' and 'Key User E-mail Address'.

In the Server Information section

In this section, you can enter your machine's network information.

- **IP Address or Host Name:** select IP Address or Host Name. If you select host name, you need to enter your DNS setting in the TCP/IP of Network Settings tab.
- **SMTP Server and Port:** enter your SMTP Server Host name or SMTP Server IP address and port that will be used to connect to the SMTP Server. Port is from 1 to 65535. The Default Value is 25.



NOTES:

- You can not select a web mail server with no SMTP support as a SMTP server.
 - Do not change port number unless you have no problem relating to firewall.
-
- **SMTP Requires Authentication:** check if the SMTP server need to be authenticated.
 - **SMTP Server Login:** enter your login name.
 - **SMTP Server Password:** enter your login password.
 - **SMTP Server Connection Timeout:** enter the timeout value. Within the timeout value, you have to access the SMTP server. You can enter from 30 to 120 seconds. The default value is 30 seconds and if there is no problem to access the SMTP server within 30 seconds, do not change the default value.
 - **Reply Address:** enter the e-mail address you want to receive a reply mail.



NOTE: If you want to receive the reply to other mail account, please type it. If blank, this will not be used.

In the Recipient list & Conditions section

In this section, you can enter the receivers' e-mail addresses who will get the E-mail Notification information and decide which information will be sent.

- **SysAdmin E-mail Address:** enter the system administrator's e-mail address.
- **Key Users E-mail Address:** enter the most important manager's e-mail address.
- **Service E-mail Address:** enter the service administrator's e-mail address.
- **Consumable Shortage Warning:** select who will receive the consumable shortage warning mail.
- **Consumable Status Report:** select who will receive the consumable status report mail.
- **Alert System Error:** select who will receive the alert system error mail.

In the Select Notification section

In this section, you can select various settings.

- **Consumable Shortage Warning:** select **Off** not to send the consumable shortage warning mail or **After the remaining level is approximately 20%** to send e-mail when the remaining items are almost at the end of their life.



NOTE: Remaining level will follow in system and there is a possibility this percentage being different.

- **Consumable Status Report:** select **Off** not to send the consumable status report mail or **Every 1000 pages** to send e-mail after printing 1000 pages. The mail contains information about firmware version, toner count and currently installed option.
- **Alert System Error:** check the option you want to know when error occurs.

Setting the Contact Information tab

Select the **Support** tab to know and enter some information in the **Contact Information** section.

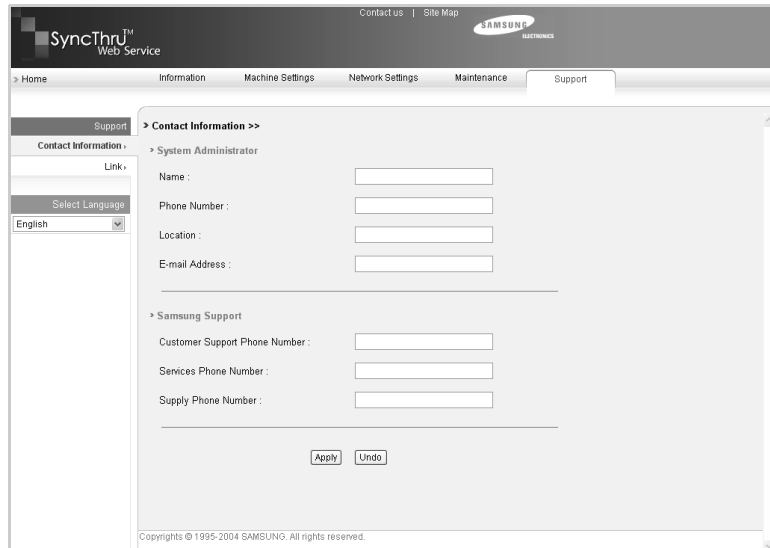

The screenshot shows the Samsung SyncThru Web Service interface. The top navigation bar includes 'Home', 'Information', 'Machine Settings', 'Network Settings', 'Maintenance', and 'Support'. The 'Support' tab is selected. On the left sidebar, there are links for 'Support', 'Contact Information', 'Link', and 'Select Language' (set to English). The main content area is titled 'Contact Information >>' and contains two sections: 'System Administrator' and 'Samsung Support'. The 'System Administrator' section has four input fields: 'Name', 'Phone Number', 'Location', and 'E-mail Address'. The 'Samsung Support' section has three input fields: 'Customer Support Phone Number', 'Services Phone Number', and 'Supply Phone Number'. At the bottom of the form are 'Apply' and 'Undo' buttons. A copyright notice at the bottom reads 'Copyrights © 1995-2004 SAMSUNG. All rights reserved.'

- **Name:** enter the e-mail sender's name like your office name.
- **Phone Number:** enter a phone number recorded in the E-mail Notification mail.
- **Location:** enter a position information recorded in the E-mail Notification mail.
- **Address:** enter the sender's e-mail address.



NOTE: It is possible that Firewall in the network will prevent e-mail transmission.

MEMO



9

TROUBLESHOOTING

This chapter gives helpful information for what to do if you encounter an error.

This chapter includes:

- **Clearing Document Jams**
- **Clearing Paper Jams**
- **Clearing LCD Error Messages**
- **Solving Other Problems**

Clearing Document Jams

When a document jams while passing through the ADF (Automatic Document Feeder), "Document Jam" appears on the display.

Input Misfeed

- 1 Remove any remaining page(s) from the ADF.
- 2 Open the ADF cover.



- 3 Rotate the bushing on the right end of the ADF roller toward the ADF (①) and remove the roller from the slot (②). Pull the document gently to the left and out of the ADF.

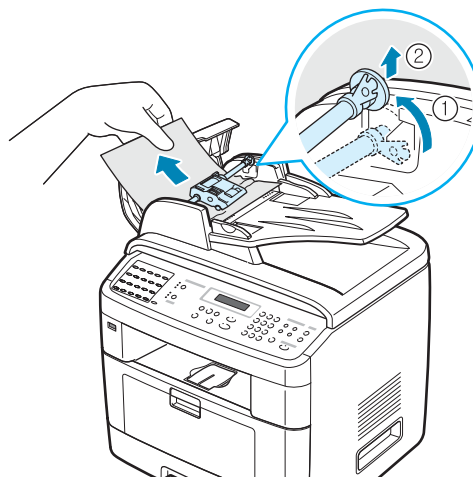

- 4 Align the left end of the ADF roller with the slot and push the right end of the ADF roller into the right slot (①). Rotate the bushing on the right end of the roller toward the document input tray (②).

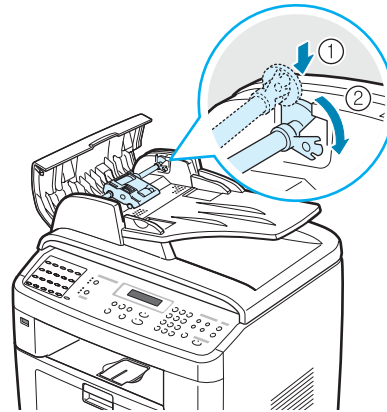

- 5 Close the ADF cover. Then load the removed page(s), if any, back into the ADF.



NOTE: To prevent document jams, use the document glass for thick, thin, or mixed paper-type documents.

Exit Misfeed

- 1 Remove any remaining page(s) from the ADF.
- 2 Open the document cover and turn the release knob to remove the misfed documents from the document output tray.

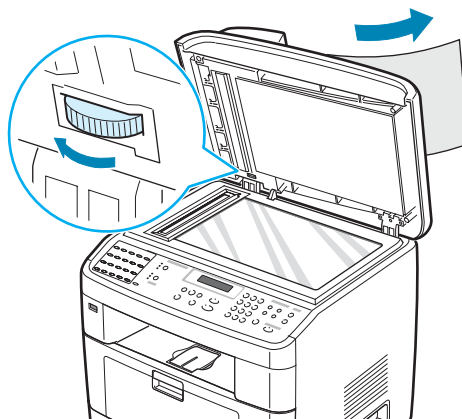

- 3 Close the document cover. Then load the removed page(s), if any, back into the ADF.

Roller Misfeed

- 1 Remove any remaining page(s) from the ADF.
- 2 Open the document cover.
- 3 Turn the release knob so that you can easily seize the misfed page, and remove the page from the roller or the feed area by carefully pulling it to the right using both hands.

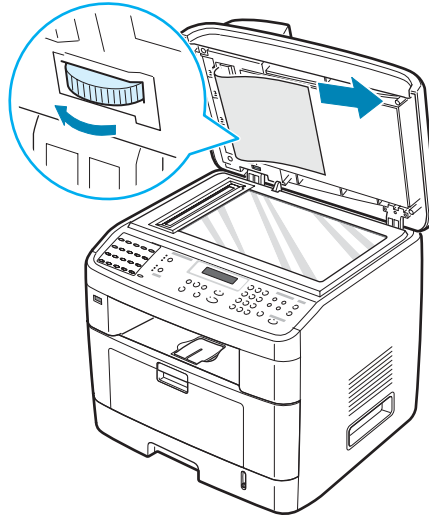

- 4 Close the document cover. Then load the removed page(s), if any, back into the ADF.

Clearing Paper Jams

When a paper jam occurs, "Paper Jam" appears on the display. Refer to the table below to locate and clear the paper jam.

Message	Location of Jam	Go to
Paper Jam 0 Open/Close Door	In the paper tray (Tray 1 or Tray 2)	below and page 9.6
Paper Jam 1 Open/Close Door	In the paper exit area	page 9.9
Paper Jam 2 Check Inside	In the fuser area or around the toner cartridge.	page 9.7
MP Tray Jam	In the Multipurpose tray	page 9.10

To avoid tearing the paper, pull out the jammed paper gently and slowly. Follow the instructions in the following sections to clear the jam.

In Tray 1

- 1 Open and close the front door. The jammed paper automatically exits the machine.

If the paper does not exit, continue to step 2.

- 2 Pull Tray 1 open.

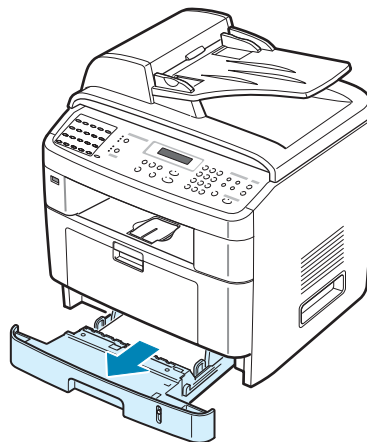

- 3 Remove the jammed paper by gently pulling it straight out.

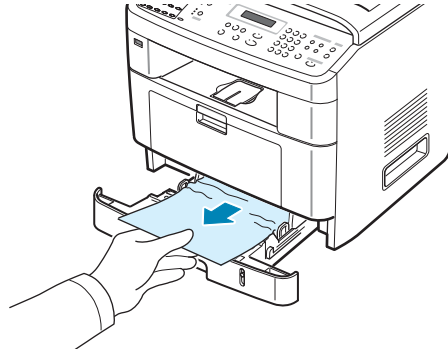

If there is any resistance and the paper does not move when you pull, or if you cannot see the paper in this area, check the fuser area around the toner cartridge. See page 9.7.

- 4 Insert the paper tray into the machine until it snaps into place.
- 5 Open and close the front door to resume printing.

In Optional Tray 2

- 1 Pull the optional Tray 2 open.
- 2 Remove the jammed paper from the machine.

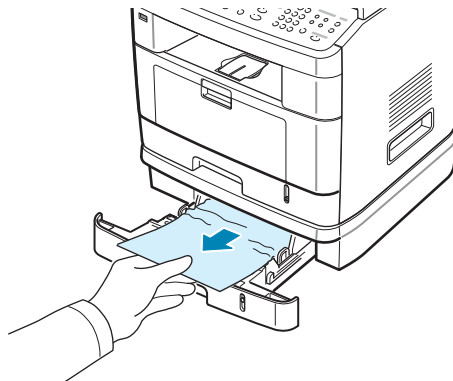

If there is any resistance and the paper does not move when you pull, or if you cannot see the paper in this area, go to step 3.

- 3 Pull the standard Tray 1 open.

- 4 Pull the paper straight up and out.

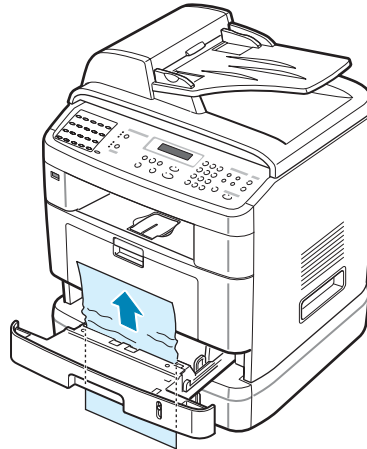

- 5 Insert Tray 1 into the machine until it snaps into place.
- 6 Open and close the front door to resume printing.

In the Fuser Area or Around the Toner Cartridge



NOTE: The fuser area is hot. Take care when removing paper from the machine.

- 1 Open the front door and pull the toner cartridge out, lightly pushing it down.

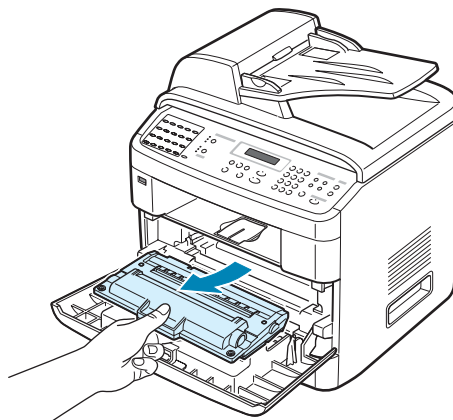

- 2 Remove the jammed paper by gently pulling it straight out.

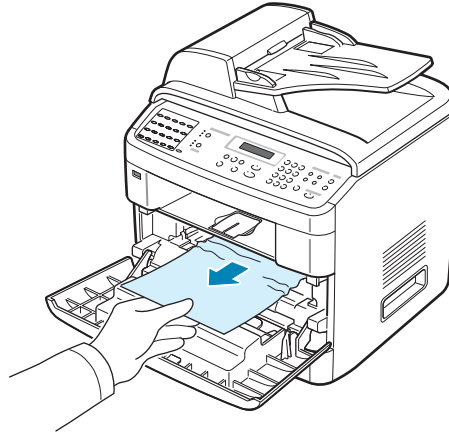

- 3 Replace the toner cartridge and close the front door. Printing automatically resumes.

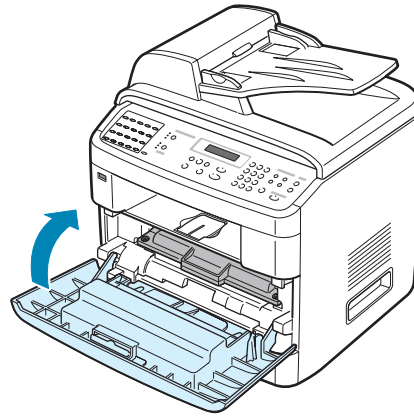

In the Paper Exit Area

- 1 Open and close the front door. The jammed paper automatically exits the machine.

If the paper does not exit, continue to step 2.

- 2 Gently pull the paper out of the front output tray. Skip to step 6.



- 3 If there is any resistance and the paper does not move when you pull, or if you cannot see the paper in the front output tray, open the rear door.

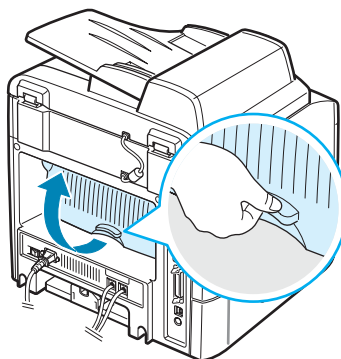

- 4 Remove the jammed paper by gently pulling it straight out.

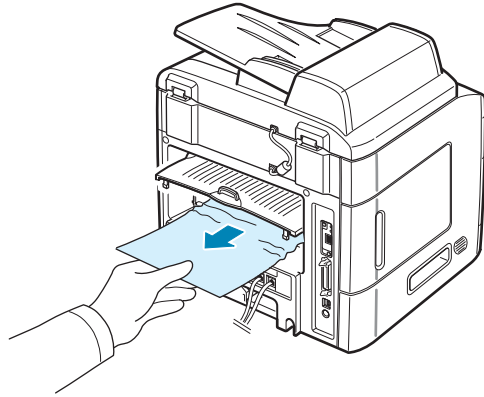

- 5 Close the rear door.

- 6 Open and close the front door to resume printing.

In the Multipurpose Tray

“MP Tray Jam” appears on the display when you try to print using the Multipurpose tray and the machine does not detect paper. This may be a lack of paper or improper paper loading.

If the paper is not feeding properly, pull the paper out of the machine.

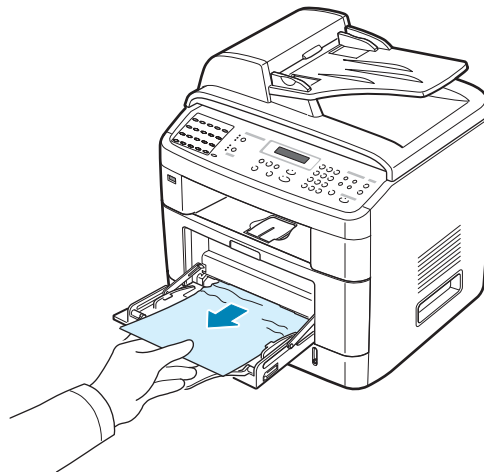

To resume printing, open and close the front door.

Tips for Avoiding Paper Jams

By selecting the correct paper types, most paper jams can be avoided. When a paper jam occurs, follow the steps outlined in "Clearing Paper Jams" on page 9.5.

- Follow the procedures in "Loading Paper" on page 2.7. Ensure that the adjustable guides are positioned correctly.
- Do not overload the paper tray. Ensure that the paper is below the paper capacity mark on the inside wall of the paper tray.
- Do not remove paper from the tray while your machine is printing.
- Flex, fan, and straighten the paper before loading.
- Do not use creased, damp, or highly curled paper.
- Do not mix paper types in the paper tray.
- Use only recommended print materials. See "Paper Specifications" on page D.6.
- Ensure that the recommended print side of print materials is facing down in the paper tray and facing up in the Multipurpose tray.
- If paper jams occur frequently when you print on A5-sized paper:
 - Load the paper into the tray, as shown below.

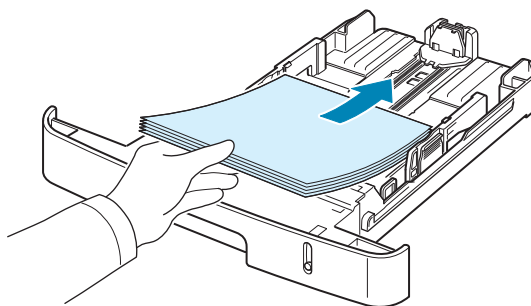

- Set the page orientation to **Landscape** in the printer properties window. See page 4.5.

Clearing LCD Error Messages

Display	Meaning	Suggested solutions
Cancel ? 1:Yes 2:No	Your machine's memory has become full while trying to store a document into memory.	To cancel the fax job, press the 1 button to accept "Yes." If you want to send these pages that have been successfully stored, press the 2 button to accept "No." You should send the remaining pages later, when memory is available.
[Comm. Error]	The machine has a communication problem.	Ask the sender to try again.
Delayed Function Full	The delayed fax jobs queue is full.	Cancel unnecessary delayed fax job.
Document Jam	The loaded document has jammed in the ADF (Automatic Document Feeder).	Clear the document jam. See page 9.2.
[Door Open]	The front door is not securely latched.	Close the door until it locks into place.
Enter Again	You entered an unavailable item.	Enter the correct item again.
Low Heat Error	There is a problem in the fuser unit.	Unplug the power cord and plug it back in. If the problem persists, please call for service.
Open Heat Error		
[Over Heat]		
Function Impossible	You have tried to use a combination of machine functions that can not be used at the same time.	Reduce the number of selected functions or use only one function at a time.
Group Not Available	You have tried to select a group location number where only a single location number can be used, such as when adding locations for a broadcast operation.	Use a speed dial number or dial a number manually using the number keypad.

Display	Meaning	Suggested solutions
[Incompatible]	The remote machine did not have the requested feature, such as a delayed transmission. This message also occurs if the remote machine does not have enough memory space to complete the operation you are attempting.	Reconfirm the remote machine's features.
[Jam 1] or [No Cartridge]	Paper has jammed in the fuser area. Or, the toner cartridge is not installed.	Clear the jam. See page 9.7. Or, install the toner cartridge. See page 2.5.
[Line Busy]	The receiving party did not answer or the line is already engaged.	Try again after a few minutes.
[Line Error]	Your machine cannot connect with the remote machine or has lost contact because of a problem with the phone line.	Try again. If the problem persists, wait an hour or so for the line to clear and try again. Or, turn the ECM mode on. See page 7.39.
Load Document	You have attempted to set up a copy or fax operation with no document loaded into the ADF.	Load a document into the ADF and try again.
[LSU Error]	A problem has occurred in the LSU (Laser Scanning Unit).	Unplug the power cord and plug it back in. If the problem persists, please call for service.
Memory Full	The memory is full.	Delete unnecessary documents and retransmit after more memory becomes available. Alternatively, split the transmission into more than one operation.
MP Tray Jam	A paper jam has occurred in the Multipurpose tray. Or, the machine detects improper feeding from the Multipurpose tray.	Clear the jam. See page 9.10. Or, load paper in the Multipurpose tray correctly. See page 3.6.

Display	Meaning	Suggested solutions
[No Answer]	The receiving fax machine has not answered after several redial attempts.	Try again. Make sure that the receiving machine is operational.
No. Not Assigned	The one-touch or speed dial location you tried to use has no number assigned to it.	Dial the number manually using the number keypad or assign the number. For storing a number, see "Automatic Dialing" on page 7.19.
Invalid Cartridge Or No Cartridge	You have used an unauthorized cartridge.	You must use a Samsung approved cartridge.
No. Not Available	You have tried to delete the number for a delayed fax job.	Verify the number to be deleted and try again. Or, delete the number after the delayed fax job has been sent.
[No Paper] Add Paper	The paper in the paper tray has run out.	Load paper in the paper tray. See page 2.7.
Operation Not Assigned	You are doing the Add/Cancel operation, but there are no jobs waiting.	Check the display to see if there are any scheduled jobs. The display should indicate them in Standby mode; for example, Delay Fax.
Paper Jam 0 Open/Close Door	Paper has jammed in the feeding area of the paper tray.	Clear the jam. See page 9.5 and page 9.6.
Paper Jam 1 Open/Close Door	Paper has jammed in the fuser area.	Clear the jam. See page 9.7.
Paper Jam 2 Check Inside	Paper has jammed in the paper exit area.	Clear the jam. See page 9.9.
[Power Failure]	Power has turned off then on and the machine's memory has not been saved.	The job which you were trying to do before the power failure must be completely re-done.
Priority Fax Function Full	The priority fax jobs queue is full.	Cancel unnecessary priority fax jobs.
[Retry Redial?]	The machine is waiting for a specified time interval to redial a previously busy station.	You can press Enter to immediately redial, or Stop/ Clear to cancel the redial operation.

Display	Meaning	Suggested solutions
Scanner Locked	The scanner module is locked	Unlock the scanner (see page 2.3) and press Stop/Clear .
[Stop Pressed]	The Stop/Clear button has been pressed during a copy or fax operation.	Try again.
Toner Empty Or [Toner Empty] Replace Toner	The toner cartridge has run out. The machine stops printing.	Replace the toner cartridge with a new one. See page 8.8.
[Toner Low]	The toner is almost empty.	Take out the toner cartridge and gently shake it. By doing this, you can temporarily reestablish printing operations.

Solving Other Problems

The following chart lists some conditions that may occur and the recommended solutions. Follow the suggested solutions until the problem is corrected. If the problem persists, please call for service.

Paper Feeding Problems

Condition	Suggested solutions
Paper is jammed during printing.	Clear the paper jam. See page 9.5.
Paper sticks together.	<ul style="list-style-type: none">• Ensure that there is not too much paper in the paper tray. The paper tray can hold up to 250 sheets of paper, depending on the thickness of your paper.• Make sure that you are using the correct type of paper. See "Paper Specifications" on page D.6.• Remove paper from the paper tray and flex or fan the paper.• Humid conditions may cause some paper to stick together.
Multiple sheets of paper do not feed.	<ul style="list-style-type: none">• Different types of paper may be stacked in the paper tray. Load paper of only one type, size, and weight.• If multiple sheets have caused a paper jam, clear the paper jam. See page 9.5.
Paper does not feed into the machine.	<ul style="list-style-type: none">• Remove any obstructions inside the machine.• Paper has not been loaded correctly. Remove paper from the tray and reload it correctly.• There is too much paper in the paper tray. Remove excess paper from the tray.• The paper is too thick. Use only paper that meets the specifications required by the machine. See "Paper Specifications" on page D.6.
The paper keeps jamming.	<ul style="list-style-type: none">• There is too much paper in the paper tray. Remove excess paper from the tray. If you are printing on special materials, use the Multipurpose tray.• An incorrect type of paper is being used. Use only paper that meets the specifications required by the machine. See "Paper Specifications" on page D.6.• There may be debris inside the machine. Open the front door and remove the debris.
Transparencies stick together in the paper exit.	Use only transparencies specifically designed for laser printers. Remove each transparency as it exits from the machine.
Envelopes skew or fail to feed correctly.	Ensure that the paper guides are against both sides of the envelopes.

Printing Problems

Condition	Possible cause	Suggested solutions
The machine does not print.	The machine is not receiving power.	Check the power cord connections. Check the power switch and the power source.
	The machine is not selected as the default printer.	Select Samsung SCX-4x20 Series PCL 6 as your default printer in your Windows.
	Check the machine for the following: <ul style="list-style-type: none"> • The front door is not closed. • Paper is jammed. • No paper is loaded. • The toner cartridge is not installed. 	After locating the problem, clear it. <ul style="list-style-type: none"> • Close the door. • Clear the paper jam. See page 9.5. • Load paper. See page 2.7. • Install the toner cartridge. See page 2.5. If a printer system error occurs, contact your service representative.
	The connection cable between the computer and the machine is not connected properly.	Disconnect the printer cable and reconnect it.
	The connection cable between the computer and the machine is defective.	If possible, attach the cable to another computer that is working properly and print a job. You can also try using a different printer cable.
	The port setting is incorrect.	Check the Windows printer setting to make sure that the print job is sent to the correct port, for example, LPT1. If the computer has more than one port, make sure that the machine is attached to the correct one.
	The machine may be configured incorrectly.	Check the printer properties to ensure that all of the print settings are correct.
	The printer driver may be incorrectly installed.	Repair the printer software. See page 2.41.
	The machine is malfunctioning.	Check the display message on the control panel to see if the machine is indicating a system error.
The machine selects print materials from the wrong paper source.	The paper source selection in the printer properties may be incorrect.	For many software applications, the paper source selection is found under the Paper tab within the printer properties. Select the correct paper source. See page 4.6.

Condition	Possible cause	Suggested solutions
A print job is extremely slow.	The job may be very complex.	Reduce the complexity of the page or try adjusting the print quality settings. The maximum print speed of your machine is 20 PPM for Letter-sized paper and 20 PPM for A4-sized paper.
	If you are using Windows 98/Me, the Spooling Setting may be set incorrectly.	From the Start menu, choose Settings and Printers . Right-click the Samsung SCX-4x20 Series PCL 6 machine icon, choose Properties , click the Details tab, and then choose the Spool Settings button. Select the desired spool setting.
Half the page is blank.	The page orientation setting may be incorrect.	Change the page orientation in your application. See page 4.5.
	The paper size and the paper size settings do not match.	Ensure that the paper size in the printer driver settings matches the paper in the tray. Or, ensure that the paper size in the printer driver settings matches the paper selection in the software application settings you use.
The machine prints, but the text is wrong, garbled, or incomplete.	The printer cable is loose or defective.	Disconnect the printer cable and reconnect. Try a print job that you have already printed successfully. If possible, attach the cable and the machine to another computer and try a print job that you know works. Finally, try a new printer cable.
	The wrong printer driver was selected.	Check the application's printer selection menu to ensure that your machine is selected.
	The software application is malfunctioning.	Try printing a job from another application.
	The operating system is malfunctioning.	Exit Windows and reboot the computer. Turn the machine off and then back on again.

Condition	Possible cause	Suggested solutions
Pages print, but are blank.	The toner cartridge is defective or out of toner.	Redistribute the toner, if necessary. See page 8.7. If necessary, replace the toner cartridge.
	The file may have blank pages.	Check the file to ensure that it does not contain blank pages.
	Some parts, such as the controller or the board, may be defective.	Contact a service representative.
The illustrations print incorrectly in Adobe Illustrator.	The setting in the software application is wrong.	Select Download as Bit Image in the TrueType Options window of the Graphic properties and print the document again.

Printing Quality Problems

If the inside of the machine is dirty or paper has been loaded improperly, you may notice a reduction in print quality. See the table below to clear the problem.

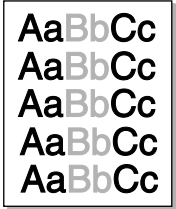
Condition	Suggested solutions
Light or faded print 	<p>If a vertical white streak or faded area appears on the page:</p> <ul style="list-style-type: none"> • The toner supply is low. You may be able to temporarily extend the toner cartridge life. See "Redistributing Toner" on page 8.7. If this does not improve the print quality, install a new toner cartridge. • The paper may not meet paper specifications; for example, the paper is too moist or too rough. See "Paper Specifications" on page D.6. • If the entire page is light, the print resolution setting is too low or the toner save mode is on. Adjust the print resolution and turn the toner save mode off. See page 4.8 and page 2.23, respectively. • A combination of faded or smeared defects may indicate that the toner cartridge needs cleaning. See "Cleaning the Drum" on page 8.10. • The surface of the LSU part inside the machine may be dirty. Clean the LSU (see page 8.4).

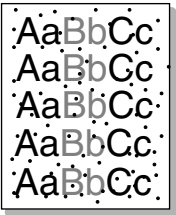
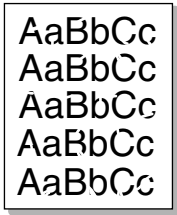
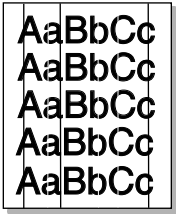
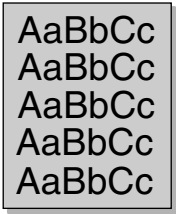
Condition	Suggested solutions
<p>Toner specs</p> 	<ul style="list-style-type: none"> • The paper may not meet specifications; for example, the paper is too moist or too rough. See "Paper Specifications" on page D.6. • The transfer roller may be dirty. Clean the inside of your machine. See "Cleaning the Inside" on page 8.3. • The paper path may need cleaning. See "Cleaning the Drum" on page 8.10.
<p>Dropouts</p> 	<p>If faded areas, generally rounded, occur randomly on the page:</p> <ul style="list-style-type: none"> • A single sheet of paper may be defective. Try reprinting the job. • The moisture content of the paper is uneven or the paper has moist spots on its surface. Try a different brand of paper. See "Paper Specifications" on page D.6. • The paper lot is bad. The manufacturing processes can cause some areas to reject toner. Try a different kind or brand of paper. • The toner cartridge may be defective. See "Vertical repetitive defects" on page 9.21. • If these steps do not correct the problem, contact a service representative.
<p>Vertical lines</p> 	<p>If black vertical streaks appear on the page:</p> <ul style="list-style-type: none"> • The drum inside the toner cartridge has probably been scratched. Remove the toner cartridge and install a new one. See "Replacing the Toner Cartridge" on page 8.8. <p>If white vertical streaks appear on the page:</p> <ul style="list-style-type: none"> • The surface of the LSU part inside the machine may be dirty. Clean the LSU (see page 8.4).
<p>Gray background</p> 	<p>If the amount of background shading becomes unacceptable:</p> <ul style="list-style-type: none"> • Change to a lighter weight paper. See "Paper Specifications" on page D.6. • Check the machine's environment: very dry (low humidity) or high humidity (higher than 80% RH) conditions can increase the amount of background shading. • Remove the old toner cartridge and install a new one. See "Replacing the Toner Cartridge" on page 8.8.

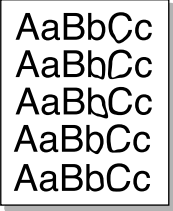
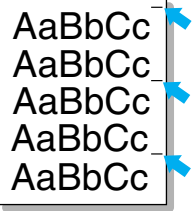
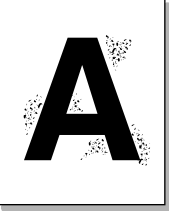
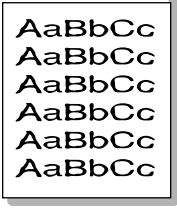
Condition	Suggested solutions
<p>Toner smear</p> 	<ul style="list-style-type: none"> • Clean the inside of the machine. See "Cleaning the Inside" on page 8.3. • Check the paper type and quality. See "Paper Specifications" on page D.6. • Remove the toner cartridge and install a new one. See "Replacing the Toner Cartridge" on page 8.8.
<p>Vertical repetitive defects</p> 	<p>If marks repeatedly appear on the printed side of the page at even intervals:</p> <ul style="list-style-type: none"> • The toner cartridge may be damaged. If a repetitive mark occurs on the page, print a cleaning sheet several times to clean the cartridge; see "Cleaning the Drum" on page 8.10. After the printout, if you still have the same problems, remove the toner cartridge and install a new one. See "Replacing the Toner Cartridge" on page 8.8. • Parts of the machine may have toner on them. If the defects occur on the back of the page, the problem will likely correct itself after a few more pages. • The fusing assembly may be damaged. Contact a service representative. • If you use inferior quality paper; see "Cleaning the Drum" on page 8.10.
<p>Background scatter</p> 	<p>Background scatter results from bits of toner randomly distributed on the printed page.</p> <ul style="list-style-type: none"> • The paper may be too damp. Try printing with a different batch of paper. Do not open packages of paper until necessary so that the paper does not absorb too much moisture. • If background scatter occurs on an envelope, change the printing layout to avoid printing over areas that have overlapping seams on the reverse side. Printing on seams can cause problems. • If background scatter covers the entire surface area of a printed page, adjust the print resolution through your software application or the printer properties.
<p>Misformed characters</p> 	<ul style="list-style-type: none"> • If characters are improperly formed and producing hollow images, the paper stock may be too slick. Try a different paper. See "Paper Specifications" on page D.6. • If characters are improperly formed and producing a wavy effect, the scanner unit may need service. For service, contact a service representative.

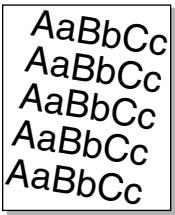
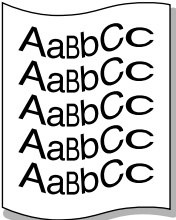
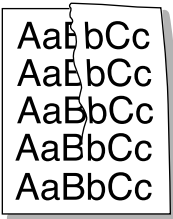
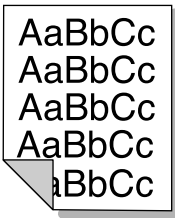
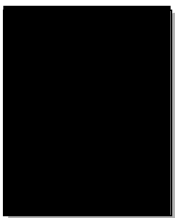
Condition	Suggested solutions
<p>Page skew</p> 	<ul style="list-style-type: none"> • Ensure that the paper is loaded properly. • Check the paper type and quality. See "Paper Specifications" on page D.6. • Ensure that the paper or other material is loaded correctly and the guides are not too tight or too loose against the paper stack.
<p>Curl or wave</p> 	<ul style="list-style-type: none"> • Ensure that the paper is loaded properly. • Check the paper type and quality. Both high temperature and humidity can cause paper curl. See "Paper Specifications" on page D.6. • Turn over the stack of paper in the paper tray. Also try rotating the paper 180° in the tray. • Try printing to the rear output slot.
<p>Wrinkles or creases</p> 	<ul style="list-style-type: none"> • Ensure that the paper is loaded properly. • Check the paper type and quality. See "Paper Specifications" on page D.6. • Turn over the stack of paper in the paper tray. Also try rotating the paper 180° in the tray. • Try printing to the rear output slot.
<p>Back of printouts are dirty</p> 	<p>Check for leaking toner. Clean the inside of the machine. See "Cleaning the Inside" on page 8.3.</p>
<p>Black pages</p> 	<ul style="list-style-type: none"> • The toner cartridge may not be installed properly. Remove the cartridge and reinsert it. • The toner cartridge may be defective and need replacing. Remove the toner cartridge and install a new one. See "Replacing the Toner Cartridge" on page 8.8. • The machine may require repair. Contact a service representative.

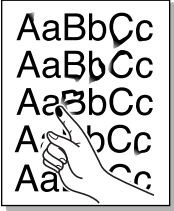
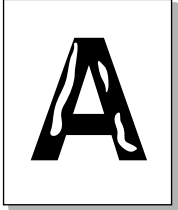
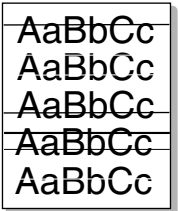
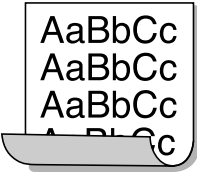
Condition	Suggested solutions
<p>Loose toner</p> 	<ul style="list-style-type: none"> • Clean the inside of the machine. See "Cleaning the Inside" on page 8.3. • Check the paper type and quality. See "Paper Specifications" on page D.6. • Remove the toner cartridge and install a new one. See "Replacing the Toner Cartridge" on page 8.8. • If the problem persists, the machine may require repair. Contact a service representative.
<p>Character Voids</p> 	<p>Character voids are white areas within parts of characters that should be solid black:</p> <ul style="list-style-type: none"> • If you are using transparencies, try another type of transparency. Because of the composition of transparencies, some character voids are normal. • You may be printing on the wrong surface of the paper. Remove the paper and turn it around. • The paper may not meet paper specifications. See "Paper Specifications" on page D.6.
<p>Horizontal stripes</p> 	<p>If horizontally aligned black streaks or smears appear:</p> <ul style="list-style-type: none"> • The toner cartridge may be installed improperly. Remove the cartridge and reinsert it. • The toner cartridge may be defective. Remove the toner cartridge and install a new one. See "Replacing the Toner Cartridge" on page 8.8. • If the problem persists, the machine may require repair. Contact a service representative.
<p>Curl</p> 	<p>If the printed paper is curled or paper does not feed into the machine:</p> <ul style="list-style-type: none"> • Turn over the stack of paper in the input tray. Also try rotating the paper 180° in the input tray. • Try printing to the rear output slot.

Copying Problems

Condition	Suggested solutions
Copies are too light or too dark.	Use the Darkness button to darken or lighten the background of the copies.
Smears, lines, marks, or spots appears on copies.	<ul style="list-style-type: none"> • If defects are on the original, press the Darkness button to lighten the background of your copies. • If no defects are on the original, clean the scan unit. See page 8.5.
Copy image is skewed.	<ul style="list-style-type: none"> • Ensure that the original is face down on the document glass or face up in the ADF (Automatic Document Feeder). • Check that the copy paper is loaded correctly.
Blank copies print out.	Ensure that the original is face down on the document glass or face up in the ADF.
Image rubs off the copy easily.	<ul style="list-style-type: none"> • Replace the paper in the paper tray with paper from a new package. • In high humidity areas, do not leave paper in the machine for extended periods of time.
Frequent copy paper jams occur.	<ul style="list-style-type: none"> • Fan the stack of paper, then turn it over in the paper tray. Replace the paper in the tray with a fresh supply. Check/adjust the paper guides, if necessary. • Ensure that the paper is the proper paper weight. 75 g/m² (20 lb) bond paper is recommended. • Check for copy paper or pieces of copy paper remaining in the machine after a paper jam has been cleared.
Toner cartridge produces fewer copies than expected before running out of toner.	<ul style="list-style-type: none"> • Your originals may contain pictures, solids, or heavy lines. For example, your originals may be forms, newsletters, books, or other documents that use more toner. • The machine may be turned on and off frequently. • The document cover may be left open while copies are being made.

Scanning Problems

Condition	Suggested solutions
The scanner does not work.	<ul style="list-style-type: none">• Make sure that you place the document to be scanned face down on the document glass, or face up in the Automatic Document Feeder.• There may not be enough available memory to hold the document you want to scan. Try the Prescan function to see if that works. Try lowering the scan resolution rate.• Check that the USB or parallel cable is connected properly.• Make sure that the USB or parallel cable is not defective. Switch the cable with a known good cable. If necessary, replace the cable.• If you are using a parallel cable, ensure that it is compliant with IEEE 1284 standards.• Check that the scanner is configured correctly. Check scan setting in the SmarThru Configuration or the application you want to use to make certain that the scanner job is being sent to the correct port, for example, LPT1.
The unit scans very slowly.	<ul style="list-style-type: none">• Check if the machine is printing received data. If so, scan the document after the received data has been printed.• Graphics are scanned more slowly than text.• Communication speed slows in scan mode because of the large amount of memory required to analyze and reproduce the scanned image. Set your computer to the ECP printer mode through BIOS setting. It will help to increase the speed. For details about how to set BIOS, refer to your computer User's Guide.

Condition	Suggested solutions
<p>Message appears on your computer screen:</p> <ul style="list-style-type: none"> • "Device can't be set to the H/W mode you want." • "Port is being used by another program." • "Port is Disabled." • "Scanner is busy receiving or printing data. When the current job is completed, try again." • "Invalid handle." • "Scanning has failed." 	<ul style="list-style-type: none"> • There may be a copying or printing job in progress. When that job is complete, try your job again. • The Selected port is currently being used. Restart your computer and try again. • The printer cable may be improperly connected or the power may be off. You must use a parallel cable that supports IEEE-1284 bi-directional communications. • The scanner driver is not installed or the operating environment is not set up properly. • Ensure that the machine is properly connected and the power is on, Then restart your computer. • The USB cable may be improperly connected or the power may be off. • Do not use parallel and USB cables at the same time.

Fax Problems

Condition	Suggested solutions
<p>The machine is not working, there is no display and the buttons are not working.</p>	<ul style="list-style-type: none"> • Unplug the power cord and plug it in again. • Ensure that there is power to the electrical outlet.
<p>No dial tone sounds.</p>	<ul style="list-style-type: none"> • Check that the phone line is connected properly. • Check that the phone socket in the wall is working by plugging in another phone.
<p>The numbers stored in memory do not dial correctly.</p>	<p>Make sure that the numbers are stored in memory correctly. Print a Phonebook list, referring to page 7.27.</p>
<p>The document does not feed into the machine.</p>	<ul style="list-style-type: none"> • Make sure that the document is not wrinkled and you are putting it in correctly. Check that the document is the right size, not too thick or thin. • Make sure that the ADF (Automatic Document Feeder) cover is firmly closed.
<p>Faxes are not received automatically.</p>	<ul style="list-style-type: none"> • Fax mode should be selected. • Make sure that there is paper in the tray. • Check to see if the display shows "Memory Full."

Condition	Suggested solutions
The machine does not send.	<ul style="list-style-type: none"> • Make sure that the document is loaded in the ADF or on the document glass. • "TX" should show up on the display. • Check the fax machine you are sending to, to see if it can receive your fax.
The incoming fax has blank spaces or is of poor-quality.	<ul style="list-style-type: none"> • The fax machine sending you the fax may be faulty. • A noisy phone line can cause line errors. • Check your machine by making a copy. • The toner cartridge may be empty. Replace the toner cartridge, referring to page 8.8.
Some of the words on an incoming fax are stretched.	The fax machine sending you the fax had a temporary document jam.
There are lines on the documents you send.	Check your scanning glass for marks and clean it. See page 8.5.
The machine dials a number, but a connection with the other fax machine fails.	The other fax machine may be turned off, out of paper, or cannot answer incoming calls. Speak with the other machine operator and ask her/him to sort out the problem.
Documents are not stored in memory.	There may not be enough memory to store the document. If the display shows a "Memory Full" message, delete from memory any documents you no longer need and then try again to store the document.
Blank areas appear at the bottom of each page or on other pages, with a small strip of text at the top.	You may have chosen the wrong paper settings in the user option setting. For details about paper settings, see page 2.20.

Network Scan Problems

Condition	Suggested solutions
I can't find a scanned image file.	You can check the scanned file's destination in the Advanced Page in the Network Scan program's Properties screen.
I can't find the scanned image file after scanning.	<p>Check if the scanned file's application is on your computer.</p> <p>Check 'Open immediately with the default application' in the Advanced Page in the Network Scan program's Properties screen to open the scanned image immediately after scanning.</p>

Condition	Suggested solutions
I forgot my ID and PIN.	Check your ID and PIN in the Server Page in the Network Scan program's Properties screen.
I can't view the Help file.	To view the Help file, you need to have Internet Explorer 4 service pack 2 or above.
I can't use the Samsung Network Scan Manager program.	Check your operating system. Supporting operating systems are Windows 98/Me/NT4.0/2000/XP.

Common Linux Problems

Problem	Possible Cause and Solution
The machine doesn't print	<ul style="list-style-type: none"> • Check if the printer driver is installed in your system. Open MFP configurator and switch to the Printers tab in Printers configuration window to look at the list of available printers. Make sure that your machine is displayed on the list. If not, please, invoke Add new printer wizard to set up your device. • Check if the printer is started. Open Printers configuration and select your machine on the printers list. Look at the description in the Selected printer pane. If its status contains "(stopped)" string, please, press the Start button. After that normal operation of the printer should be restored. The "stopped" status might be activated when some problems in printing occurred. For instance, this could be an attempt to print document when MFP port is claimed by a scanning application. • Check if the MFP port is not busy. Since functional components of MFP (printer and scanner) share the same I/O interface (MFP port), the situation of simultaneous access of different "consumer" application to the same MFP port is possible. To avoid possible conflicts, only one of them at a time is allowed to gain control over the device. The other "consumer" will encounter "device busy" response. You should open MFP ports configuration and select the port assigned to your printer. In the Selected port pane you can see if the port is occupied by some other application. If this is the case, you should wait for completion of the current job or should press Release port button, if you are sure that the present owner is not functioning properly. <p>Check if your application has special print option such as "-oraw". If "-oraw" is specified in the command line parameter then remove it to print properly. For Gimp front-end, select "print" -> "Setup printer" and edit command line parameter in the command item.</p>

Problem	Possible Cause and Solution
<p>The machine does not appear on the scanners list</p>	<ul style="list-style-type: none"> • Check if your machine is attached to your computer. Make sure that it is connected properly via the USB port and is turned on. • Check if the scanner driver for you machine is installed in your system. Open MFP Configurator, switch to Scanners configuration, then press Drivers. Make sure that driver with a name corresponding to your machine's name is listed in the window. • Check if the MFP port is not busy. Since functional components of MFP (printer and scanner) share the same I/O interface (MFP port), the situation of simultaneous access of different "consumer" application to the same MFP port is possible. To avoid possible conflicts, only one of them at a time is allowed to gain control over the device. The other "consumer" will encounter "device busy" response. This can usually happen while starting scan procedure, and appropriate message box displays. To identify the source of the problem, you should open MFP ports configuration and select the port assigned to your scanner. MFP port's symbol /dev/mfp0 corresponds to LP:0 designation displayed in the scanners' options, /dev/mfp1 relates to LP:1 and so on. USB ports start at /dev/mfp4, so scanner on USB:0 relates to /dev/mfp4 respectively and so forth sequentially. In the Selected port pane you can see if the port is occupied by some other application. If this is the case, you should wait for completion of the current job or should press Release port button, if you are sure that the present port's owner is not functioning properly.

Problem	Possible Cause and Solution
The machine doesn't scan	<ul style="list-style-type: none"> • Check if a document is loaded into the machine. • Check if your machine is connected to the computer. Make sure if it is connected properly if I/O error is reported while scanning. • Check if MFP port is not busy. Since functional components of MFP (printer and scanner) share the same I/O interface (MFP port), the situation of simultaneous access of different "consumer" application to the same MFP port is possible. To avoid possible conflicts, only one of them at a time is allowed to gain control over the device. The other "consumer" will encounter "device busy" response. This can usually happen while starting scan procedure, and appropriate message box will be displayed. To identify the source of the problem, you should open MFP ports configuration and select the port assigned to your scanner. MFP port's symbol /dev/mfp0 corresponds to LP:0 designation displayed in the scanners' options, /dev/mfp1 relates to LP:1 and so on. USB ports start at /dev/mfp4, so scanner on USB:0 relates to /dev/mfp4 respectively and so forth sequentially. In the Selected port pane you can see if the port is occupied by some other application. If this is the case, you should wait for completion of the current job or should press Release port button, if you are sure that the present port's owner is not functioning properly.
I can't print when I installed both Linux Print Package (LPP) and MFP driver on the same machine simultaneously.	<ul style="list-style-type: none"> • Since both Linux Printer Package and MFP driver make a symbolic link to "lpr" printing command, which is commonly used on Unix clones, it is not recommended to use both package on the same machine. • If you still want to use both packages simultaneously, please install the LPP first. • If you want to uninstall only one of them, please uninstall both packages and install that one you want to use again. • If you don't want to uninstall MFP driver and install it again, you may make the necessary symbolic link yourself. Please, log in as root user and invoke the following command: <code>In -sf /usr/local/bin/samsung/slpr /usr/bin/lpr</code>
Can't scan via Gimp Front-end.	<ul style="list-style-type: none"> • Check if Gimp Front-end has "Xsane:Device dialog.." on the "Acquire" menu. If not, you should install Xsane plug-in for Gimp on the your computer. You can find Xsane plug-in package for Gimp on Linux distribution CD or Gimp home page. For the detail information, refer to the Help for Linux distribution CD or Gimp Front-end application. If you wish to use other kind of scan application, refer to the Help for application.

Problem	Possible Cause and Solution
I encounter error "Unable to open MFP port device file!" when printing a document.	Please avoid changing print job parameters (via SLPR utility, for example) while a print job is in progress. Known versions of CUPS server break the print job whenever print options are changed and then try to restart the job from the beginning. Since Linux MFP driver locks MFP port while printing, the abrupt termination of the driver keeps the port locked and therefore unavailable for subsequent print jobs. If this situation occurred, please, try to release the MFP port.

MEMO



10

USING USB FLASH DRIVE

This chapter explains how to use a USB flash drive with your machine.

This chapter includes:

- **About USB Flash Drives**
- **Installing a USB Flash Drive**
- **Scanning to USB Flash Drive**
- **Managing the USB Flash Drive**
- **Printing From the USB Flash Drive**
- **Backing Up Data**

About USB Flash Drives

USB flash drives are available with various memory capacities to give you enough room to store documents, presentations, downloaded music and videos, high resolution photographs, or whatever other files you want to take with you.

Simply insert a USB flash drive into the USB port in the front of your machine and your machine will automatically detect it as a removable disk drive. Then you can do the following:

- Scan documents and save them on the USB flash drive.
- Print the data stored on the USB flash drive.
- Back up data, such as Phonebook entries and the system settings of your machine.
- Restore backup files to the machine's memory.
- Delete scanned images.
- Format the USB flash drive.
- Check the available memory space.
- USB 1.1 or 2.0 memory sticks are supported.



NOTE: Part of function of USB 2.0 is not supported.

Installing a USB Flash Drive

There is a USB port in the front of your machine. This port is designed for USB V1.1 and USB V2.0 flash drives.



CAUTIONS:

- Do not remove the USB flash drive while the machine is in operation. This may damage your machine.
- If your USB flash drive has certain features, such as security settings and password settings, your machine may not automatically detect it. For details about these features, see the User's Guide for your USB flash drive.

- You must use only an authorized USB flash driver whose connector style is A Plug Type. Unauthorized USB flash drives may not work with your machine.

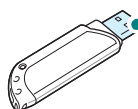

Use only the metal/shielded USB flash driver.

To install a USB flash drive, insert it into the USB port in the front of your machine.

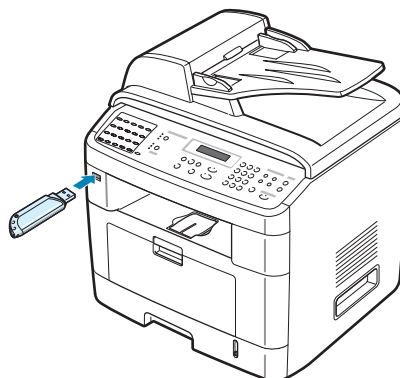

Once you have installed the USB flash drive, you can immediately print files stored on it.

Scanning to USB Flash Drive

You can scan a document and save the scanned image on the USB flash drive. There are two ways of doing this: you can scan to the USB flash drive using the default settings, or you can manually select your own settings.

Scanning With Default Settings

- 1 Load the document face up into the ADF.

OR

Place a single document face down on the document glass.

For details about loading a document, see page 7.6.

- 2 Make sure that the USB flash drive is inserted into the USB port in the front of the machine. If necessary, insert the flash drive. See page 10.2.

- 3** Press **Scan-to** on the control panel.
The first available menu item, "USB Memory," appears on the bottom line of the display.
- 4** Press **Enter**. The display shows the available memory space for about 2 seconds and the first available menu item, "Auto Scan," appears on the bottom line of the display.
- 5** Press **Enter** to start scanning. The scanned image is saved on the USB flash drive.
- 6** When a document is loaded on the document glass, the display shows "Another Page?" on the top line after the page has been scanned into memory. If you have another page, remove the scanned page and place the next page on the glass. Select "Yes". Repeat as necessary.

After all of the pages have been scanned, select "No" when the display asks "Another Page?."
- 7** To return to Standby mode, press **Stop/Clear**.

Scanning With Your Own Settings

- 1** Load the document face up into the ADF.

OR

Place a single document face down on the document glass.

For details about loading a document, see page 7.6.
- 2** Make sure that the USB flash drive is inserted into the USB port in the front of the machine. If necessary, insert the flash drive. See page 10.2.
- 3** Press **Scan-to** on the control panel.
The first available menu item, "USB Memory," appears on the bottom line of the display.
- 4** Press **Enter**. The display shows the available memory space for about 2 seconds and the first available menu item, "Auto Scan," appears on the bottom line of the display.
- 5** Press the scroll button (◀ or ▶) until "Manual Scan" appears on the bottom line of the display. Press **Enter**.

- 6 Press the scroll button (◀ or ▶) and select the size of the image to be scanned. Press **Enter**.
- 7 Press the scroll button (◀ or ▶) and select the file format in which the document is to be scanned.
- 8 Press **Enter**.
- 9 If you selected "BMP" in step 7, you are asked to select a color format, Color, Gray, or Mono, by pressing the scroll button (◀ or ▶).

If you selected "PDF" in step 7, you are asked to select a color format, Color or Mono, by pressing the scroll button (◀ or ▶). You can save a multiple-page document as a single file, the machine displays "Multi-Page Scan" and offers you the choice of "On" or "Off." If you select "On" you can save multiple pages as a single file, but this feature is only activated when you load your document into the ADF. The ADF can handle documents of up to 50 pages at a time.

If you selected "TIFF" in step 7, you can save a multiple-page document as a single file. After you select "TIFF", the machine displays "Multi-Page Scan" and offers you the choice of "On" or "Off." If you select "On" you can save multiple pages as a single file, but this feature is only activated when you load your document into the ADF. The ADF can handle documents of up to 50 pages at a time.

- 10 Press **Enter** to start scanning. The scanned image is saved on the USB flash drive.
- 11 When a document is loaded on the document glass, the display shows "Another Page?" on the top line after the document has been scanned into memory. If you have another page, remove the scanned page and load the next page on the glass. Select "Yes". Repeat as necessary.

After all of the pages have been scanned, select "No" when the display asks "Another Page?."
- 12 To return to Standby mode, press **Stop/Clear**.

Managing the USB Flash Drive

Changing the Default Settings

When you scan a document to the USB flash drive, the default scan options, including scan size and scan format, can be set to the most frequently used modes. These settings are only available when you scan to the USB flash drive.

1 Make sure that the USB flash drive is inserted into the USB port in the front of the machine. If necessary, insert the USB flash drive. See page 10.2.

2 Press **Scan-to** on the control panel.

The first available menu, item "USB Memory," appears on the bottom line of the display.

3 Press **Enter**. The display shows the available memory space for about 2 seconds and the first available menu item, "Auto Scan," appears on the bottom line of the display.

4 Press the scroll button (◀ or ▶) until "Default-Change" appears on the bottom line of the display.

5 Press **Enter**.

The first available menu item, "Scan Size," appears on the bottom line.

6 Press **Enter**.

7 Press the scroll button (◀ or ▶) and select the size of the image to be scanned.

8 Press **Enter** to make your selection.

9 Press the ▶ button to scroll to "Scan Format" and press **Enter** to access the menu.

10 Press the scroll button (◀ or ▶) and select the file format in which the document is to be scanned. You can select BMP, TIFF, PDF, or JPEG.

11 Press **Enter**.

- 12** If you selected "BMP" in step 10, you are asked to select a color format, Color, Gray, or Mono, by pressing the scroll button (◀ or ▶).

If you selected "PDF" in step 10, you are asked to select a color format, Color, or Mono, by pressing the scroll button (◀ or ▶). You can save a multiple-page document as a single file, the machine displays "Multi-Page Scan" and offers you the choice of "On" or "Off." If you select "On" you can save multiple pages as a single file, but this feature is only activated when you load your document into the ADF. The ADF can handle documents of up to 50 pages at a time.

If you selected "TIFF" in step 10, you can save a multiple-page document as a single file. After you select "TIFF", the machine displays "Multi-Page Scan" and offers you the choice of "On" or "Off." If you select "On" you can save multiple pages as a single file, but this feature is only activated when you load your document into the ADF. The ADF can handle documents of up to 50 pages at a time.

- 13** Press **Enter** to make your selection.

- 14** To return to Standby mode, press **Stop/Clear**.

Deleting an Image File

To delete an image file that you scanned and saved on the USB flash drive:

- 1** Make sure that the USB flash drive is inserted into the USB port in front of the machine. If necessary, insert the USB flash drive. See page 10.2.

- 2** Press **Scan-to** on the control panel.

The first available menu item, "USB Memory," appears on the bottom line of the display.

- 3** Press **Enter**. The display shows the available memory space for about 2 seconds and the first available menu item, "Auto Scan," appears on the bottom line of the display.

- 4** Press the scroll button (◀ or ▶) until you see "File Manage" on the bottom line and press **Enter**.

The first available menu item, "Delete," appears on the bottom line of the display.

- 5** Press **Enter**.

- 6 Press the scroll button (◀ or ▶) until you find the folder or file you want and then press **Enter**.

If you see "D" in the front of a folder name, there are one or more folders in the selected folder.

- 7 If you selected a file in step 6, the display shows the size of the file for about 2 seconds. Go to the next step.

If you selected a folder, the first file contained in that folder appears on the bottom line of the display. You can view the other files in the folder by pressing the scroll button (◀ or ▶). When you find the file you want to delete, press **Enter**. The display shows the size of the file for about 2 seconds.

- 8 When the display asks you to confirm your selection, select "Yes" to delete the folder or file.

To cancel your selection, select "No" by pressing the scroll button (◀ or ▶).

- 9 After deleting, the display asks if you want to delete another folder or file. Select "Yes" to delete more items, and repeat from step 6.

Otherwise, select "No" by pressing the scroll button (◀ or ▶).

Formatting the USB Flash Drive

- 1 Make sure that the USB flash drive is inserted into the USB port in the front of the machine. If necessary, insert the USB flash drive. See page 10.2.

- 2 Press **Scan-to** on the control panel.

The first available menu item, "USB Memory," appears on the bottom line of the display.

- 3 Press **Enter**. The display shows the available memory space for about 2 seconds and the first available menu item, "Auto Scan," appears on the bottom line of the display.

- 4 Press the scroll button (◀ or ▶) until you see "File Manage" on the bottom line and press **Enter**.

- 5 Press the scroll button (◀ or ▶) until you see "Format" on the bottom line and press **Enter**.

- 6 When the display asks you to confirm your selection, select "Yes" to format the USB flash drive.

To cancel your selection, select "No" by pressing the scroll button (◀ or ▶).

Viewing the USB Memory Status

You can check the amount of memory space available for scanning and saving documents.

- 1 Make sure that the USB flash drive is inserted into the USB port in the front of the machine. If necessary, insert the USB flash drive. See page 10.2.

- 2 Press **Scan-to** on the control panel.

The first available menu item, "USB Memory," appears on the bottom line of the display.

- 3 Press **Enter**. The display shows the available memory space for about 2 seconds and the first available menu item, "Auto Scan," appears on the bottom line of the display.

- 4 Press the scroll button (◀ or ▶) until you see "Check Space" on the bottom line and press **Enter**.

- 5 The available memory space appears on the display.

To return to the Standby mode, press **Stop/Clear**.

Printing From the USB Flash Drive

You can directly print files stored on the USB flash drive. You can print TIFF, BMP, JPEG, and PRN files.

Direct Print option supports:

- PRN : Samsung PCL6 Compatible
- BMP : BMP Uncompressed
- TIFF : TIFF 6.0 Baseline
Copyright© 1988-1997, Sam Leffler
Copyright© 1991-1997, Silicon Graphics, Inc.
- JPEG : JPEG Baseline
Copyright© 1991-1998, Thomas G. Lane

PRN files can be created by selecting **Print** when your file is open, selecting your machine in the **Name** section of the Print window, and then selecting the **Print to file** check box. Save the newly made PRN file to the USB flash drive. Only PRN files created in this fashion can be printed directly from the USB flash drive to the machine.

- 1** Insert the USB flash drive into the USB port in the front of your machine. For details, see page 10.2.

You can also press **DIRECT PRINT** without installing the USB flash drive.

Your machine automatically detects the USB flash drive and reads data stored on it.

- 2** Press the scroll button (◀ or ▶) to select the folder or file you want to print and press **Enter**.

If you see "D" in the front of a folder name, there are one or more folders in the selected folder.

- 3** If you selected a file in step 2, go to the next step.

If you selected a folder in step 2, the first file name in the folder appears on the bottom line of the display. You can also view the other files in the folder by pressing the scroll button (◀ or ▶). When you find the file that you want to print, go to step 4.

- 4** To print the selected file, press **Enter**, **Start**, or **DIRECT PRINT**.

If you selected a TIFF, BMP, or JPEG file in step 2, you can select the number of copies to be printed by pressing the scroll button (◀ or ▶) or entering the number using the numeric keys. Then press **Enter** to print the file.

- 5 After printing the file, the display asks if you want to print another job. Select "Yes" to print another jobs, and repeat from step 2. Otherwise, select "No".
- 6 To return to Standby mode, press **Stop/Clear**.

Backing Up Data

Your data in the machine's memory are accidentally erased due to power failure or storage failure. Backup helps you protect your Phonebook entries and the system settings by storing them as backup files on the USB flash drive.

To back up the data:

- 1 Insert the USB flash drive. For details, see page 10.2.
- 2 Press **Menu** until "Machine Setup" appears on the top line of the display.
- 3 Press the scroll button (◀ or ▶) until you see "Export Setting" on the bottom line and press **Enter**.
- 4 If you want to back up the Phonebook entries, when "Phonebook" appears on the bottom line, press **Enter**.

If you want to back up the system settings of the machine, select "All Settings" by pressing the scroll button (◀ or ▶) and press **Enter**.
- 5 The data is backed up in the USB flash drive.

If the file name is already stored on the USB flash drive, you are asked to overwrite it. Select "Yes" to overwrite the data.

Otherwise, select "No" by pressing the scroll button (◀ or ▶).
- 6 To return to Standby mode, press **Stop/Clear**.

To restore the data:

- 1** Insert the USB flash drive. For details, see page 10.2.
- 2** Press **Menu** until "Machine Setup" appears on the top line of the display.
- 3** Press the scroll button (◀ or ▶) until you see "Import Setting" on the bottom line and press **Enter**.
- 4** Select the data type you want to restore, either "Phonebook" or "All Settings" and press **Enter**.
- 5** Select the file you want to restore and press **Enter**.
The first available menu item, "Yes," appears on the bottom line.
- 6** Press **Enter** to restore the backup file to the machine.
- 7** To return to Standby mode, press **Stop/Clear**.





USING YOUR MACHINE IN LINUX

You can use your machine in a Linux environment.

This chapter includes:

- **Getting Started**
- **Installing the MFP Driver**
- **Using the MFP Configurator**
- **Configuring Printer Properties**
- **Printing a Document**
- **Scanning a Document**

Getting Started

The supplied CD-ROM provides you with Samsung's MFP driver package for using your machine with a Linux computer.

Samsung's MFP driver package contains printer and scanner drivers, providing the ability to print documents and scan images. The package also delivers powerful applications for configuring your machine and further processing of the scanned documents.

After the driver is installed on your Linux system, the driver package allows you to monitor a number of MFP devices via fast ECP parallel ports and USB simultaneously. The acquired documents can then be edited, printed on the same local MFP or network printers, sent by e-mail, uploaded to an FTP site, or transferred to an external OCR system.

The MFP driver package is supplied with a smart and flexible installation program. You don't need to search for additional components that might be necessary for the MFP software: all required packages will be carried onto your system and installed automatically; this is possible on a wide set of the most popular Linux clones.

Installing the MFP Driver

System Requirements

Supported OS

- Redhat 7.1 and above
- Linux Mandrake 8.0 and above
- SuSE 7.1 and above
- Caldera OpenLinux 3.1 and above
- Turbo Linux 7.0 and above
- Slackware 8.1 and above

Recommended Hardware Requirements

- Pentium IV 1 GHz or higher
- RAM 256 MB or higher
- HDD 1 GB or higher



NOTES:

- It's also necessary to claim swap partition of 300 MB or larger for working with large scanned images.
 - The Linux scanner driver supports the optical resolution at maximum. see "Scanner and Copier Specifications" on page D.3.
-

Software

- Linux Kernel 2.4 or higher
- Glibc 2.2 or higher
- CUPS
- SANE

Installing the MFP Driver

- 1 Make sure that you connect your machine to your computer. Turn both the computer and the machine on.
- 2 When the Administrator Login window appears, type in *root* in the Login field and enter the system password.



NOTE: You must log in as a super user (*root*) to install the printer software. If you are not a super user, ask your system administrator.

- 3 Insert the printer software CD-ROM. The CD-ROM will automatically run.

If the CD-ROM does not automatically run, click the  icon at the bottom of the desktop. When the Terminal screen appears, type in:

```
[root@localhost root]#cd /mnt/cdrom/Linux
```

```
[root@localhost root]#./install.sh
```



NOTE: The installation program runs automatically if you have an autorun software package installed and configured.

- 4 Click **Install**.



- 5 When the welcome screen appears, click **Next**.



- 6 When the installation is complete, click **Finish**.

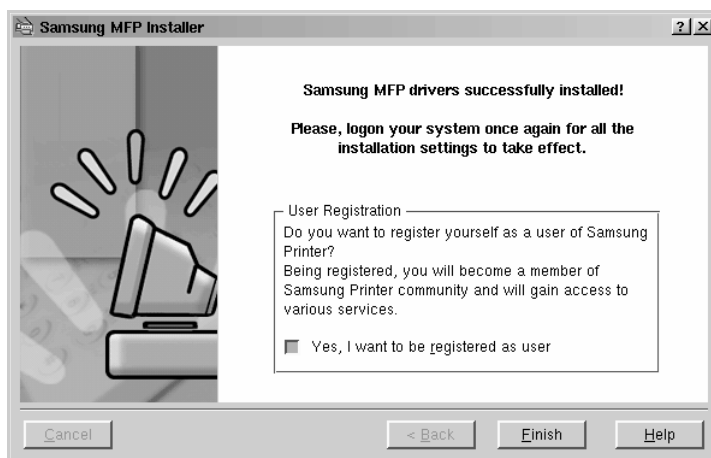

The installation program has added the MFP Configurator desktop icon and Samsung MFP group to the system menu for your convenience. If you have any difficulties, consult the onscreen help that is available through your system menu or can otherwise be called from the driver package windows applications, such as MFP Configurator or Image Editor.

Uninstalling the MFP Driver

- 1 When the Administrator Login window appears, type in *root* in the Login field and enter the system password.



NOTE: You must log in as a super user (*root*) to install the printer software. If you are not a super user, ask your system administrator.

- 2 Insert the printer software CD-ROM. The CD-ROM will automatically run.

If the CD-ROM does not automatically run, click the  icon at the bottom of the desktop. When the Terminal screen appears, type in:

```
[root@localhost root]#cd /mnt/cdrom/Linux
```

```
[root@localhost root]#./install.sh
```



NOTE: The installation program runs automatically if you have an autorun software package installed and configured.

- 1 Click **Uninstall**.
- 2 Click **Next**.

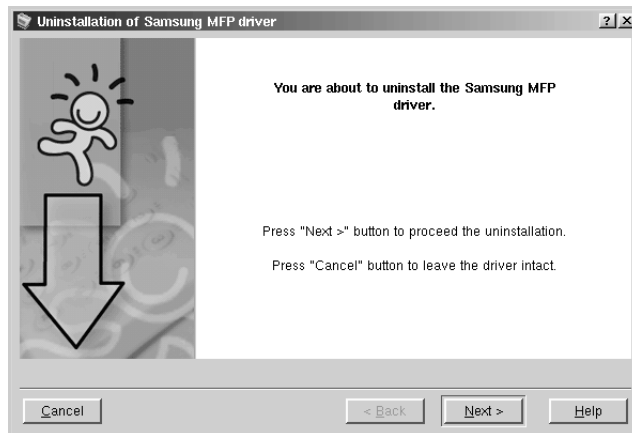

- 3 Click **Finish**.

Using the MFP Configurator

MFP Configurator is a tool primarily intended for configuring MFP devices. Since an MFP device combines the printer and scanner, the MFP Configurator provides options logically grouped for printer and scanner functions. There is also a special MFP port option responsible for the regulation of access to an MFP printer and scanner via a single I/O channel.

After installing the MFP driver (see page A.3), the MFP Configurator icon will automatically be created on your desktop.

Opening the MFP Configurator

- 1 Double-click **MFP Configurator** on the desktop.
You can also click the Startup Menu icon and select **Samsung MFP** and then **MFP Configurator**.
- 2 Press each button on the Modules pane to switch to the corresponding configuration window.

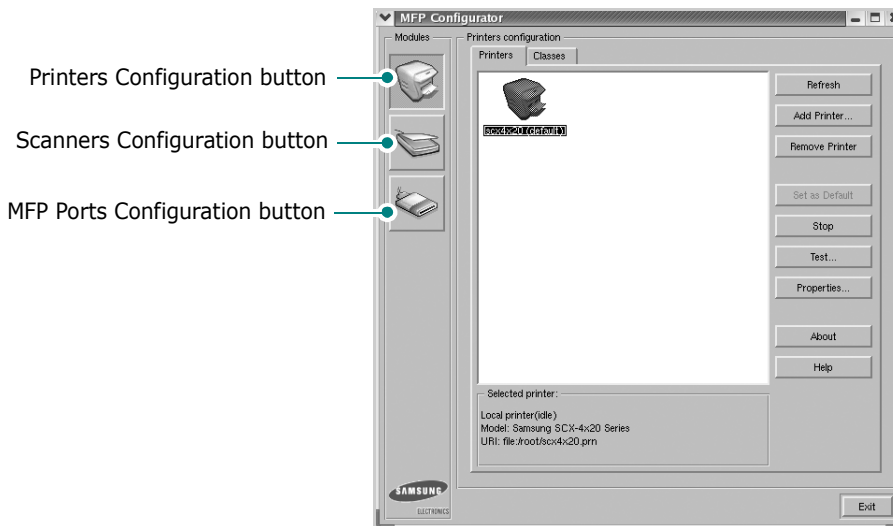

You can use the onscreen help by clicking **Help**.

- 3 After changing the configurations, click **Exit** to close the MFP Configurator.

Printers Configuration

Printers configuration has the two tabs; **Printers** and **Classes**.

Printers Tab

You can see the current system's printer configuration by clicking on the printer icon button on the left side of the MFP Configurator window.

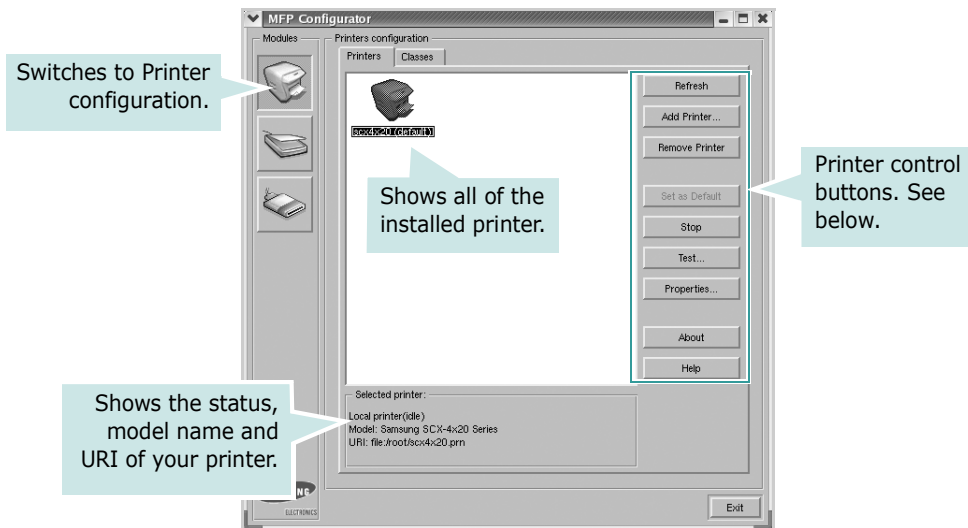

You can use the following printer control buttons:

- **Refresh:** renews the available printers list.
- **Add Printer:** allows you to add a new printer.
- **Remove Printer:** removes the selected printer.
- **Set as Default:** sets the current printer as a default printer.
- **Stop/Start:** stops/starts the printer.
- **Test:** allows you to print a test page to check if the machine is working properly.
- **Properties:** allows you to view and change the printer properties. For details, see page A.11.

Classes Tab

The Classes tab shows a list of available printer classes.

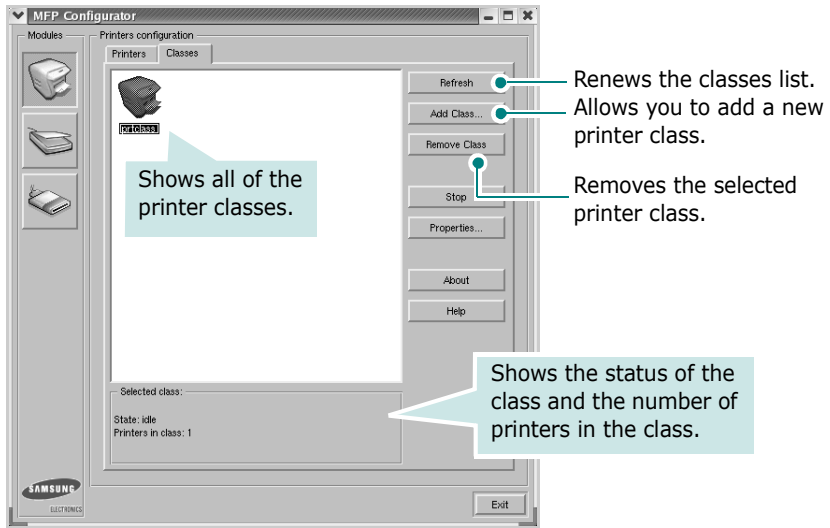

Scanners Configuration

In this window, you can monitor the activity of scanner devices, view a list of installed Samsung MFP devices, change device properties, and scan images.

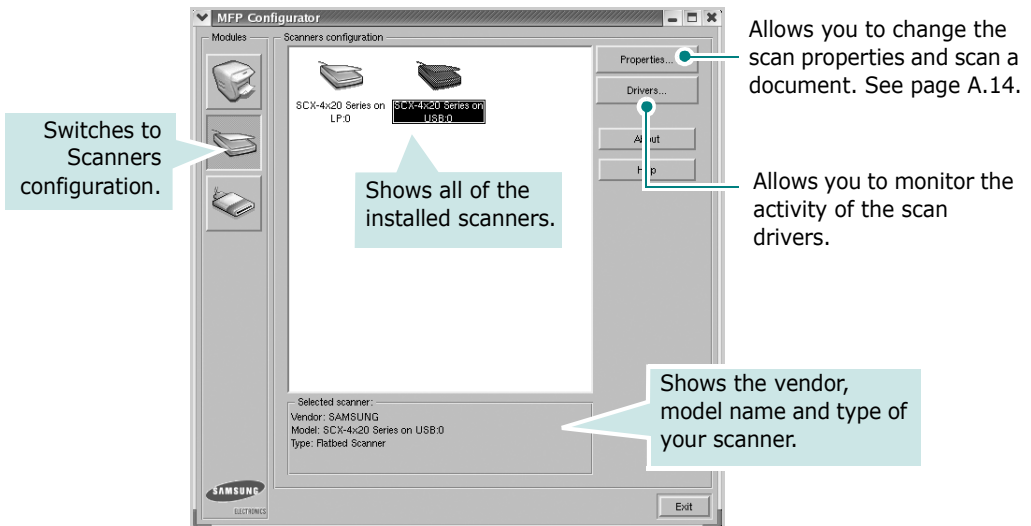

MFP Ports Configuration

In this window, you can view the list of available MFP ports, check the status of each port and release a port that is stalled in busy state when its owner is terminated for any reason.

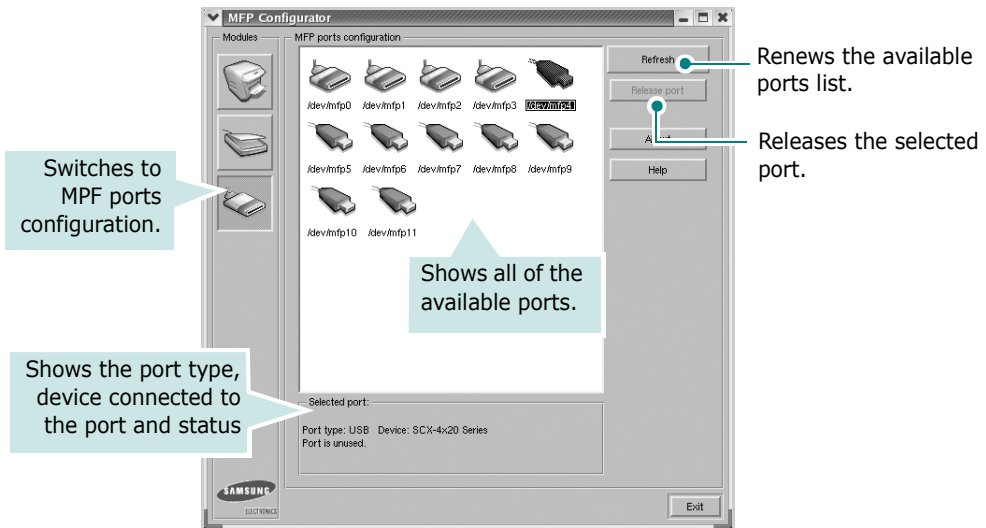

Sharing Ports Between Printers and Scanners

Your machine may be connected to a host computer via the parallel port or USB port. Since the MFP device contains more than one device (printer and scanner), it is necessary to organize proper access of “consumer” applications to these devices via the single I/O port.

The Samsung MFP driver package provides an appropriate port sharing mechanism that is used by Samsung printer and scanner drivers. The drivers address their devices via so-called MFP ports. The current status of any MFP port can be viewed via the MFP Ports Configuration. The port sharing prevents you from accessing one functional block of the MFP device, while another block is in use.

When you install a new MFP printer onto your system, it is strongly recommended you do this with the assistance of an MFP Configurator. In this case you will be asked to choose I/O port for the new device. This choice will provide the most suitable configuration for MFP’s functionality. For MFP scanners I/O ports are being chosen by scanner drivers automatically, so proper settings are applied by default.

Configuring Printer Properties

Using the properties window provided by the Printers configuration, you can change the various properties for your machine as a printer.

- 1 Open the MFP Configurator.
If necessary, switch to Printers configuration.
- 2 Select your machine on the available printers list and click **Properties**.
- 3 The Printer Properties window opens.

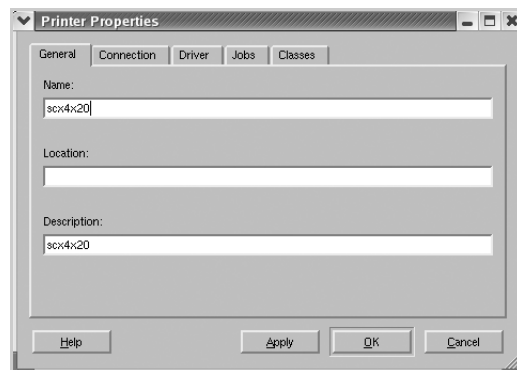

The following five tabs display at the top of the window:

- **General:** allows you to change the printer location and name. The name entered in this tab displays on the printer list in Printers configuration.
- **Connection:** allows you to view or select another port. If you change the printer port from USB to parallel or vice versa while in use, you must re-configure the printer port in this tab.
- **Driver:** allows you to view or select another printer driver. By clicking **Options**, you can set the default device options.
- **Jobs:** shows the list of print jobs. Click **Cancel job** to cancel the selected job and select the **Show completed jobs** check box to see previous jobs on the job list.
- **Classes:** shows the class that your printer is in. Click **Add to Class** to add your printer to a specific class or click **Remove from Class** to remove the printer from the selected class.

- 4 Click **OK** to apply the changes and close the Printer Properties Window.

Printing a Document

Printing from Applications

There are a lot of Linux applications that you are allowed to print from using Common UNIX Printing System (CUPS). You can print on your machine from any such application.

- 1 From the application you are using, select **Print** from the **File** menu.
- 2 Select **Print** directly using **lpr**.
- 3 In the Samsung LPR window, select the model name of your machine from the Printer list and click **Properties**.

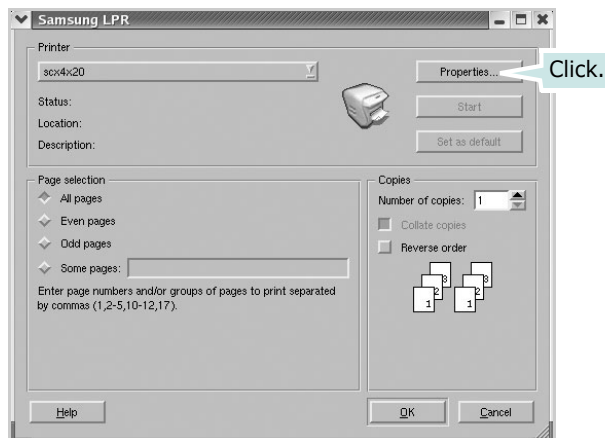

- 4 Change the printer and print job properties.

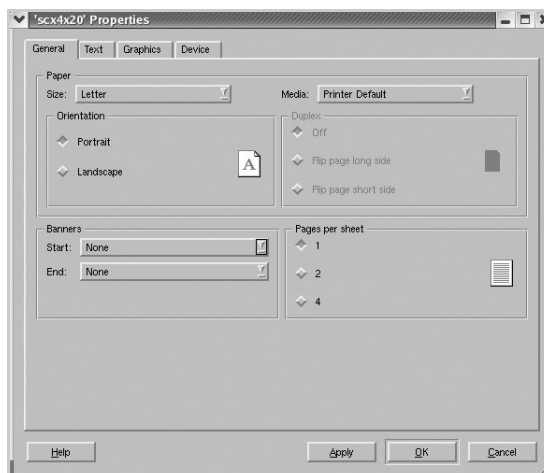

The following four tabs display at the top of the window.

- **General** - allows you to change the paper size, the paper type, and the orientation of the documents, enables the duplex feature, adds start and end banners, and changes the number of pages per sheet.
- **Text** - allows you to specify the page margins and set the text options, such as spacing or columns.
- **Graphics** - allows you to set image options that are used when printing images/files, such as color options, image size, or image position.
- **Device** - allows you to set the print resolution, paper source, and destination.

- 5 Click **OK** to apply the changes and close the scx4x20 Properties window.
- 6 Click **OK** in the Samsung LPR window to start printing.
- 7 The Printing window appears, allowing you to monitor the status of your print job.

To abort the current job, click **Cancel**.

Printing Files

You can print many different types of files on the Samsung MFP device using the standard CUPS way - directly from the command line interface. The CUPS `lpr` utility allows you do that. But the drivers package replaces the standard `lpr` tool by a much more user-friendly Samsung LPR program.

To print any document file:

- 1 Type `lpr <file_name>` from the Linux shell command line and press **Enter**. The Samsung LPR window appears.

When you type only `lpr` and press **Enter**, the Select file(s) to print window appears first. Just select any files you want to print and click **Open**.

- 2 In the Samsung LPR window, select your printer from the list, and change the printer and print job properties.

For details about the properties window, see page A.12.

- 3 Click **OK** to start printing.

Scanning a Document

You can scan a document using the MFP Configurator window.

- 1 Double-click the MFP Configurator on your desktop.
- 2 Click the  button to switch to Scanners Configuration.
- 3 Select the scanner on the list.



When you have only one MFP device and it is connected to the computer and turned on, your scanner appears on the list and is automatically selected.

If you have two or more scanners attached to your computer, you can select any scanner to work at any time. For example, while acquisition is in progress on the first scanner, you may select the second scanner, set the device options and start the image acquisition simultaneously.



NOTE: The scanner name shown in Scanners configuration can be different from the device name.

- 4 Click **Properties**.
- 5 Load the document to be scanned face up into the ADF (Automatic Document Feeder) or face down on the document glass. For details, see page 7.6.

For detailed guidelines for preparing an original document, see page 5.3.

6 Click **Preview** in the Scanner Properties window.

The document is scanned and the image preview appears in the Preview Pane.

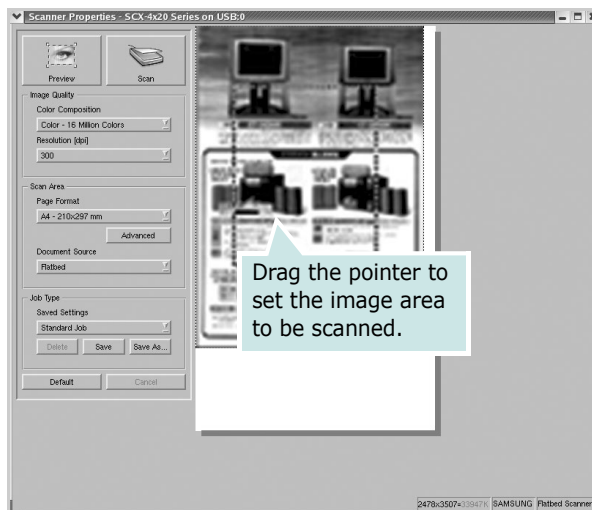

7 Change the scan options in the Image Quality and Scan Area sections.

- **Image Quality:** allows you to select the color composition and the scan resolution for the image.
- **Scan Area:** allows you to select the page size. The **Advanced** button enables you to set the page size manually.

If you want to use one of the preset scan option settings, select from the Job Type drop-down list. For details about the preset Job Type settings, see page A.16.

You can restore the default setting for the scan options by clicking **Default**.

8 When you have finished, click **Scan** to start scanning.

The status bar appears on the bottom left of the window to show you the progress of the scan. To cancel scanning, click **Cancel**.

- 9 The scanned image appears in the new Image Editor window.

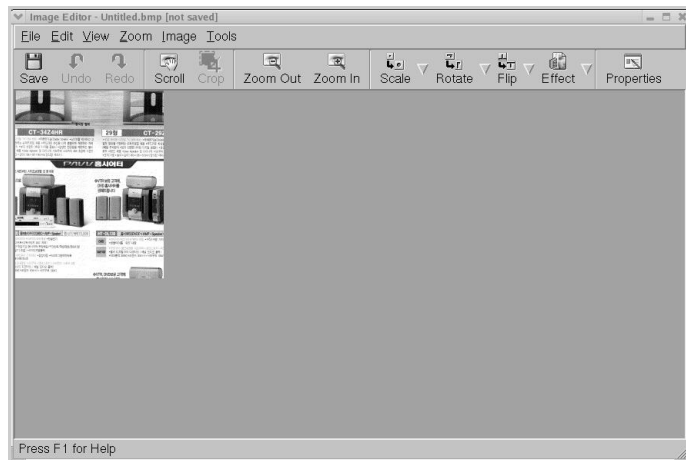

If you want to edit the scanned image, use the toolbar. For further details about editing an image, see page A.17.

- 10 When you are finished, click **Save** on the toolbar.
- 11 Select the file directory where you want to save the image and enter the file name.
- 12 Click **Save**.

Adding Job Type Settings

You can save your scan option settings to retrieve for a later scanning.

To save a new Job Type setting:

- 1 Change the options from the Scanner Properties window.
- 2 Click **Save As**.
- 3 Enter the name for your setting.
- 4 Click **OK**.

Your setting is added to the Saved Settings drop-down list.

To save a Job Type setting for the next scan job:

- 1 Select the setting you want to use from the Job Type drop-down list.

2 Click **Save**.

The next time you open the Scanner Properties window, the saved setting is automatically selected for the scan job.

To delete a Job Type setting:

1 Select the setting you want to delete from the Job Type drop-down list.

2 Click **Delete**.





The setting is deleted from the list

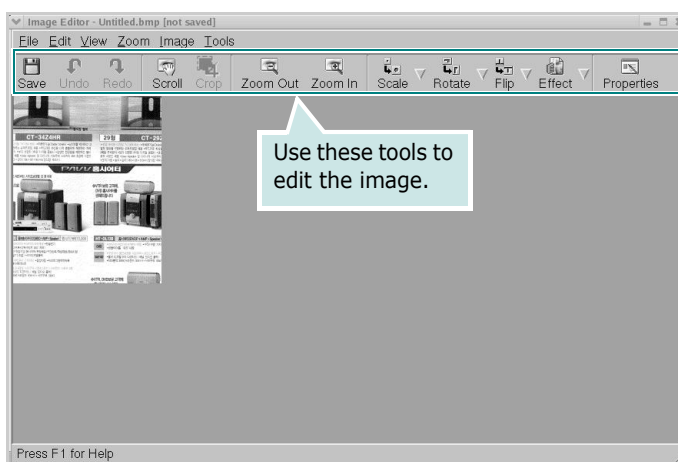







Using the Image Editor

The Image Editor window provides you with menu commands and tools to edit your scanned image.



You can use the following tools to edit the image:

Tools	Function
 Save	Saves the image.
 Undo	Cancels your last action.
 Redo	Restores the action you canceled.
 Scroll	Allows you to scroll through the image.

Tools	Function
 Crop	Crops the selected image area.
 Zoom Out	Zooms the image out.
 Zoom In	Zooms the image in.
 Scale	Allows you to scale the image size; you can enter the size manually, or set the rate to scale proportionally, vertically, or horizontally.
 Rotate	Allows you to rotate the image; you can select the number of degrees from the drop-down list.
 Flip	Allows you to flip the image vertically or horizontally.
 Effect	Allows you to adjust the brightness or contrast of the image, or to invert the image.
 Properties	Shows the properties of the image.

For further details about the Image Editor program, refer to the onscreen help.





USING YOUR MACHINE ON A NETWORK

If you work in a networked environment, the machine can be shared by other users on the network.

This chapter includes:

- **About Sharing the Machine on a Network**
- **Setting Up a Locally-Shared Machine**
- **Setting Up a Network-Connected Machine**

About Sharing the Machine on a Network

If you work in a networked environment, you can connect your machine to the network.

Locally-Shared Machine

You can connect the machine directly to a selected computer, which is called the "host computer" on the network. The machine can then be shared by other users on the network through a Windows 98/Me/NT 4.0/2000/XP network printer connection.

Printing Across a Network

Whether the machine is locally-connected or network-connected, you need to install the SCX-4x20 Series printer software on each computer that prints documents using the machine.

Setting Up a Locally-Shared Machine

In Windows 98/Me

Setting Up the Host Computer

- 1 Start Windows.
- 2 From the **Start** menu, select **Control Panel** from **Settings** and double-click on the **Network** icon.
- 3 Check the **File and Print Sharing** box, and click **OK**. Close the window.
- 4 From the **Start** menu, select **Printers** from **Settings** and double-click your machine name.
- 5 Select **Properties** in the **Printer** menu.
- 6 Click the **Sharing** tab and check the **Shared As** box. Fill in the **Shared Name** field and click **OK**.

Setting Up the Client Computer

- 1 Right-click the Windows **Start** button and select **Explorer**.
- 2 Open your network folder in the left column.
- 3 Right-click the shared name and select **Capture Printer Port**.
- 4 Select the port you want, check the **Reconnect at log on box**, and click **OK**.
- 5 From the **Start** menu, select **Settings** and then **Printers**.
- 6 Double-click your machine icon.
- 7 From the **Printer** menu, select **Properties**.
- 8 From the **Details** tab, select the printer port and click **OK**.

In Windows NT 4.0/2000/XP

Setting Up the Host Computer

- 1 Start Windows.
- 2 For Windows NT 4.0/2000, from the **Start** menu, select **Settings** and then **Printers**.
For Windows XP, from the **Start** menu, select **Printers and Faxes**.
- 3 Double-click your machine icon.
- 4 From the **Printer** menu, select **Sharing**.
- 5 For Windows NT 4.0, check the **Shared** box.
For Windows 2000, check the **Shared As** box.
For Windows XP, check the **Share this printer** box.
- 6 Fill in the **Shared Name** field and click **OK**.

Setting Up the Client Computer

- 1 Right-click the Windows **Start** button and select **Explorer**.
- 2 Open your network folder in the left column.
- 3 Click the shared name.
- 4 For Windows NT 4.0/2000, from the **Start** menu, select **Settings** and **Printers**.
For Windows XP, from the **Start** menu, select **Printers and Faxes**.
- 5 Double-click your machine icon.
- 6 From the **Printer** menu, select **Properties**.
- 7 From the **Ports** tab, click **Add Port**.
- 8 Select **Local port** and click **New Port**.
- 9 In the **Enter a port name** field, enter the shared name.

10 Click **OK** and click **Close**.

11 For Windows NT 4.0, click **OK**.

For Windows 2000/XP, click **Apply** and click **OK**.

Setting Up a Network-Connected Machine

You have to set up the network protocols on the machine to use it as your network printer. Setting protocols can be accomplished by using the supplied network program. Please refer to the Network User's Guide.

You can configure the basic network parameters through the machine's control panel. Use the machine's control panel to do the following:

- Print a Network Configuration Page
- Enable or disable network protocols (IPX/SPX)
- Configure TCP/IP
- Configure IPX frame types

Configuring Network Parameters on the Control Panel

Supported Operating Systems



NOTE: The operating systems supported by the network card may be different from the operating systems supported by the machine. The following table shows the network environments supported by the machine.

Item	Requirements
Network Interface	10/100 Base-TX
Network Operating System	<ul style="list-style-type: none">• Novell Netware 4.x, 5.x, 6.x• Windows 98/Me/NT 4.0/2000/XP• Unix AT&T, BSD4.3, HP-UX, SUN OS, SOLARIS, SCO• Various Linux OS

Item	Requirements
Network Protocols	<ul style="list-style-type: none"> • Netware IPX/SPX • TCP/IP, DLC/LLC on Windows • Port9100 on Unix, Linux
Dynamic Addressing Server	DHCP, BOOTP

- IPX/SPX: Internet Packet eXchange/Sequenced Packet eXchange
- TCP/IP: Transmission Control Protocol/Internet Protocol
- DLC/LLC: Data Link Control/Logical Link Control
- DHCP: Dynamic Host Configuration Protocol
- BOOTP: Bootstrap Protocol

Printing a Network Configuration Page

The Network Configuration page shows how the network interface card on your machine is configured. The default settings which are suitable for most applications are enabled.

1 Press **Menu** until you see "Network Setup" on the top line of the display.

2 Press the scroll button (◀ or ▶) until "Print Net CFG" displays on the bottom line.

3 Press **Enter**.

The first available menu item, "Yes," displays on the bottom line.

4 Press **Enter**.

The Network Configuration page prints out.

Setting Network Protocols

When you first install the machine, all supported network protocols are enabled when you turn the machine on. If a network protocol is enabled, the machine may actively transmit on the network even when the protocol is not in use. This may increase network traffic slightly. To eliminate unnecessary traffic, you can disable unused protocols.

1 Press **Menu** until you see "Network Setup" on the top line of the display.

2 Press the scroll button (◀ or ▶) until "Config Network" displays on the bottom line.

- 3 Press **Enter** to access the menu.
- 4 Press the scroll button (◀ or ▶) until you see the desired protocol on the bottom line.
- 5 Press **Enter**.

If you selected "TCP/IP," assign a TCP/IP address. For details, see page B.7.

If you selected "NetWare", set the frame type format. For details, see page B.9.
- 6 Press **Enter** to save the selection.
- 7 Press **Stop/Clear** to return to Standby mode.

Configuring TCP/IP

Your machine can be set up with a variety of TCP/IP networks information, such as an IP address, a Subnet Mask, and a Gateway. There are several ways in which your machine can be assigned a TCP/IP address, depending on your network.

- Static Addressing: A TCP/IP address is assigned manually by the system administrator.
- Dynamic Addressing BOOTP/DHCP (default): A TCP/IP address is assigned automatically by the server.



NOTE: Before configuring the TCP/IP, you need to set network protocol to TCP/IP.

Static Addressing

To enter the TCP/IP address from your machine's control panel, take the following steps:

- 1 Press **Menu** until you see "Network Setup" on the top line of the display.
- 2 Press the scroll button (◀ or ▶) until "Config Network" displays on the bottom line.
- 3 Press **Enter** to access the menu.

The first available menu item, "TCP/IP," appears on the bottom line.
- 4 Press **Enter**.

The first available menu item, "Manual," appears on the bottom line.

- 5 Press **Enter**.

The first available menu item, "IP Address," displays on the bottom line.

- 6 Press **Enter** to access the IP Address menu.

An IP address consists of 4 bytes.

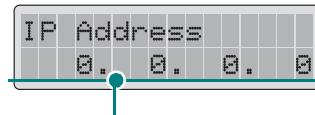

Enter a number between 0 and 255 for each byte.

- 7 Press the scroll button (◀ or ▶) to enter a number between 0 and 255 and press **Enter** or **Upper Level** to move between bytes.

You can enter a number using the number keypad and use the scroll button (◀ or ▶) to move between bytes.

- 8 Repeat step 7 to complete the address from the 1st byte to the 4th byte.

- 9 Press **Enter**.

- 10 To select other parameters, such as a Subnet Mask or a Gateway, press the scroll button (◀ or ▶) until the desired item displays on the bottom line. Press **Enter**.

- 11 Repeat steps 7 through 9 to configure the other TCP/IP parameters.

- 12 Press **Stop/Clear** to return to Standby mode.

Dynamic Addressing (BOOTP/DHCP)

To have the TCP/IP address assigned automatically by the server, take the following steps:

- 1 Press **Menu** until you see "Network Setup" on the top line of the display.

- 2 Press the scroll button (◀ or ▶) until "Config Network" appears on the bottom line.

- 3 Press **Enter**.

The first available menu item, "TCP/IP," appears on the bottom line.

- 4 Press the scroll button (◀ or ▶) to display "DHCP" on the bottom line and press **Enter**.

- 5 To assign the address from the BOOTP server, press **Enter** when "BOOTP" displays on the bottom line.

Configuring IPX Frame Types

On IPX/SPX protocol networks (for example, Novell NetWare), the format of the network communication frames must be specified for the machine. In most cases, you can keep the "Auto" default setting. However, you can manually set the frame type format, if required.

- **Off**: The IPX/SPX protocol is disabled.
- **Auto** (default): Automatically senses and limits the frame type to the first one detected.
- **Enable 802.3**: Limits the frame type to IPX over IEEE 802.3 frames. All others will be discarded.
- **Ethernet II**: Limits the frame type to IPX over Ethernet Frames. All others will be discarded.
- **Enable 802.2**: Limits the frame type to IPX over IEEE 802.2 with IEEE 802.3 frames. All others will be discarded.
- **Enable SNAP**: Limits the frame type to IPX over SNAP with IEEE 802.3 frames. All others will be discarded.

Take the following steps to change the frame type format:

- 1 Press **Menu** until you see "Network Setup" on the top line of the display.

- 2 Press the scroll button (◀ or ▶) until "Config Network" displays on the bottom line.

- 3 Press **Enter** to access the menu.

- 4 Press the scroll button (◀ or ▶) until "NetWare" displays on the bottom line. Press **Enter**.

The first available menu item, "Off," displays on the bottom line.

- 5 Press the scroll button (◀ or ▶) until you see the desired frame type and press **Enter**.

- 6 Press the **Stop/Clear** to return to Standby mode.

Restoring the Network Configuration

You can return the network configuration to its default settings.

- 1 Press **Menu** until you see "Network Setup" on the top line of the display.
- 2 Press the scroll button (◀ or ▶) until "Set To Default" displays on the bottom line.
- 3 Press **Enter**.
The first available menu item, "Yes," displays on the bottom line.
- 4 Press **Enter** to restore the network configuration.
- 5 Power the machine off and back on, or reboot the network interface card.

Rebooting the Network Interface Card

You can simply reboot the network interface card without turning your machine off and back on.

- 1 Press **Menu** until you see "Network Setup" on the top line of the display.
The first available item, "Reset Network," displays on the bottom line.
- 2 Press **Enter**.
The first available menu item, "Yes," displays on the bottom line.
- 3 Press **Enter** to reboot the network interface card.





INSTALLING MACHINE OPTIONS

Your machine is a full-featured laser printer that has been optimized to meet most of your printing needs. Recognizing that each user may have different requirements, however, Samsung makes several options available to enhance your machine's capabilities.

This chapter includes:

- **Installing Memory DIMM**
- **Installing an Optional Tray**

Installing Memory DIMM

Your machine has dual in-line memory module (DIMM) slot. Use this DIMM slot to install more memory option for the machine.



NOTE: Your machine has 64 MB of memory which can be expanded to 192 MB. Use only a Samsung-approved DIMM, part numbers ML-00MA (16 MB), ML-00MB (32 MB), ML-00MC (64 MB), or ML-00MD (128 MB). Contact your Samsung dealer.



CAUTION: Static electricity can damage DIMMs. When handling a DIMM, either wear an antistatic wrist strap, or frequently touch the surface of the DIMM antistatic package and then touch bare metal on the machine.

- 1 Turn the machine off and unplug all cables from the machine.
- 2 Hold the control board cover and remove it.

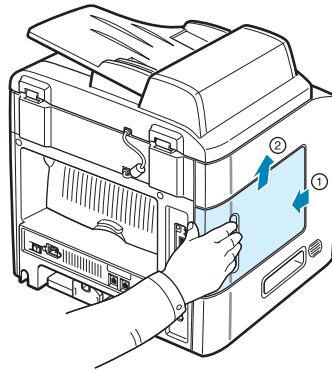

- 3 Completely open the latches on each side of the DIMM slot.

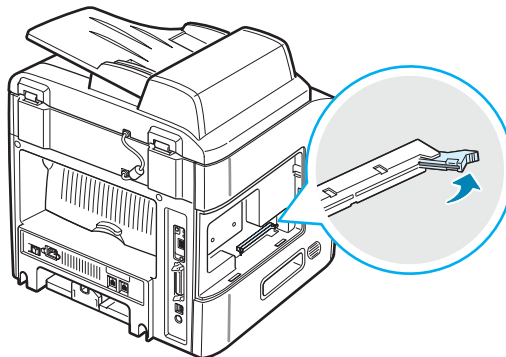

- 4 Remove the memory DIMM from its antistatic package. Locate the alignment notches on the bottom edge of each DIMM.

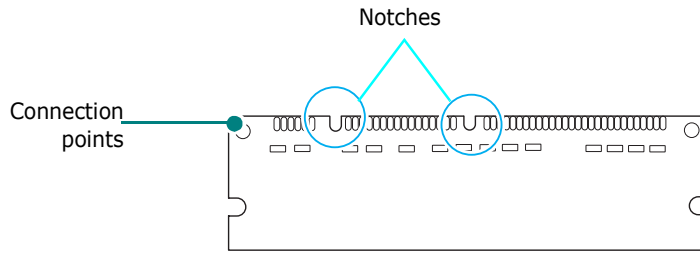

- 5 Holding the memory DIMM by the edges, align the notches on the memory DIMM with the grooves at the top of the memory DIMM slot.

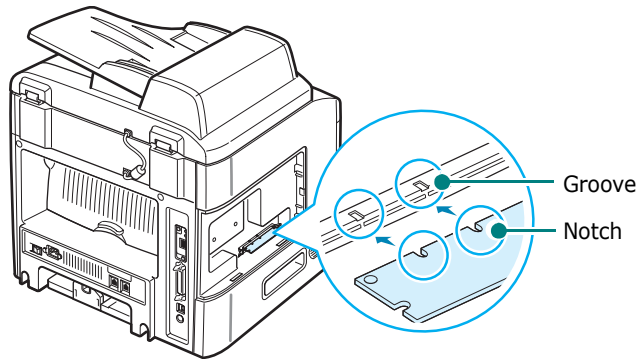

- 6 Push the DIMM straight into the DIMM slot until it snaps into place. Make sure the latches fit over the notches located on either side of the DIMM.

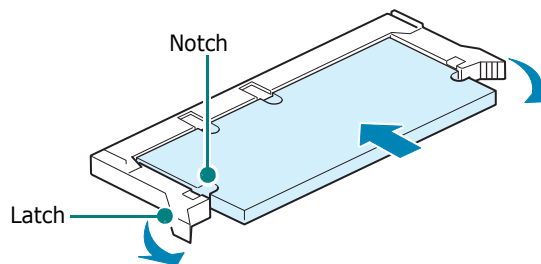

- 7 Replace the control board cover.

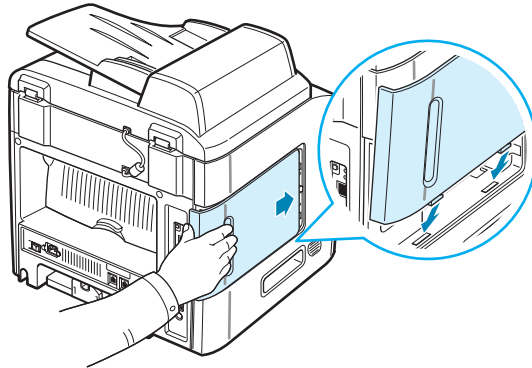

- 8 Reconnect the power cord and printer cable, and turn the machine on.

Removing a Memory DIMM

- 1 Follow steps 1 through 2 on page C.2 to access the control board.
- 2 Push the latches at both ends of the DIMM slot away from the DIMM. Pull out the DIMM.

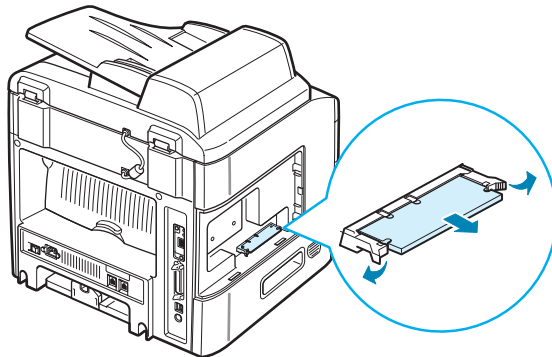

- 3 Place the DIMM in its original packaging or wrap it with a sheet of thin metal, such as aluminium foil, and store it in a box.
- 4 Follow from step 7 on page C.4.

Installing an Optional Tray

You can increase the paper handling capacity of your machine by installing an optional Tray 2. This tray holds 250 sheets of paper.

- 1 Turn the machine off and unplug all cables from the machine.
- 2 Remove the packing material from the tray and remove the tape fixing the interface cable to the tray.

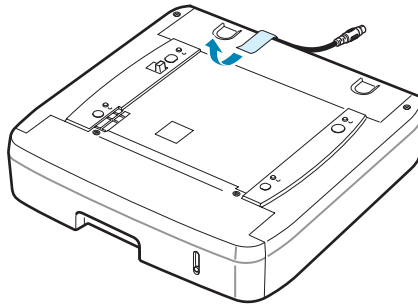

- 3 Find the location of the connector and the optional tray positioners.

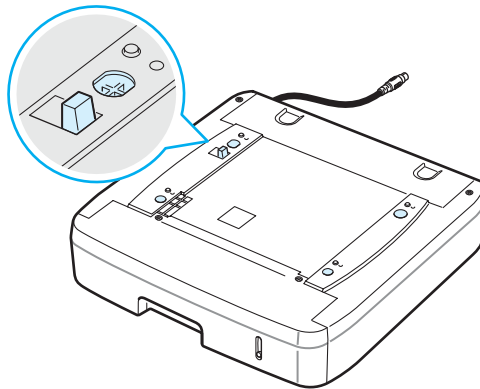

- 4 Place the machine over the tray, aligning the feet on the machine with the positioners on the tray.

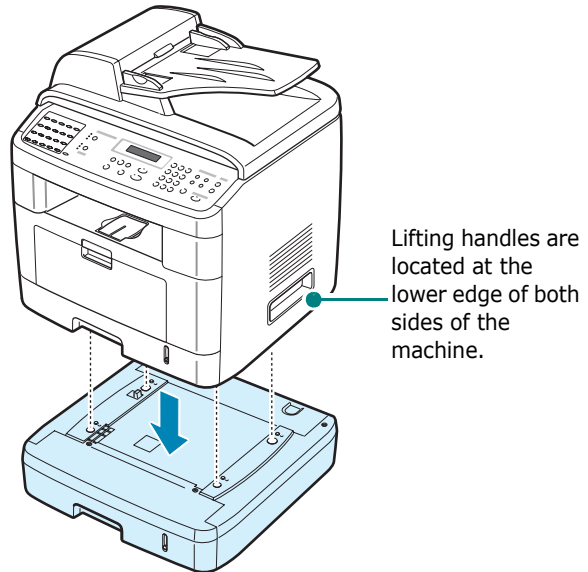

- 5 Plug the interface cable of the tray into the connector on the back of the machine.

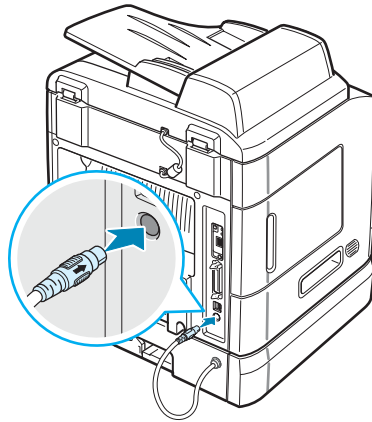

- 6 Load paper in the tray. The instructions for loading paper in this tray are the same as for loading the standard paper tray. See page 2.7.
- 7 After loading paper, you need to set the paper type and size for Tray 2. See page 2.20.
- 8 Reconnect the power cord and cables and then turn the machine on.

Setting Tray 2 in the Printer Properties

If you installed Tray 2 with your machine on, the machine does not recognize it. In this case, you need to set the tray in the printer properties window so that you can use it for PC printing. The procedure for setting the tray may differ depending on the selected printer driver.

To set the tray in the printer properties of the PCL 6 printer driver:

- 1 Click the Windows **Start** menu.
- 2 For Windows 98/Me/NT 4.0/2000, select **Settings** and then **Printers**.
For Windows XP, select **Printers and Faxes**.
- 3 Select the **Samsung SCX-4x20 Series PCL 6** machine icon.
- 4 Click the right mouse button on the machine icon and select **Properties**.
- 5 Click the **Printer** tab, and select **Tray 2** from the **Optional Tray** drop-down list.

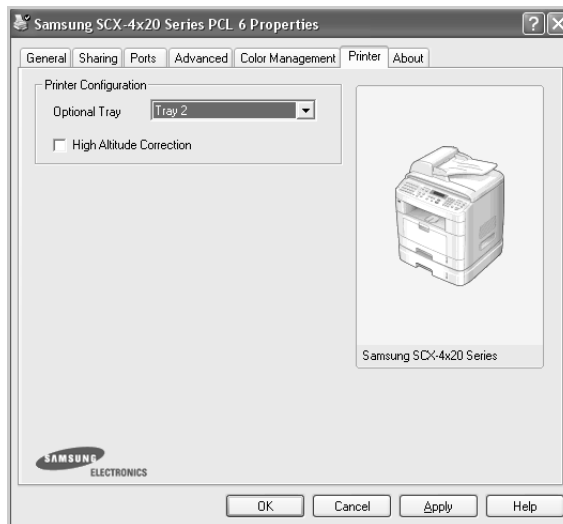

- 6 Click **OK**.

MEMO





SPECIFICATIONS

This chapter includes:

- **General Specifications**
- **Scanner and Copier Specifications**
- **Printer Specifications**
- **Facsimile Specifications**
- **Paper Specifications**

General Specifications

Item	Description
Model name	SCX-4720FN (RK20MFF)
Automatic document feeder	Up to 50 sheets (20 lb, 75 g/m ²)
ADF document size	Width: 142 to 216 mm (5.6 to 8.5 inches) Length: 148 to 356 mm (5.8 to 14 inches)
Paper input capacity	Paper tray (standard Tray 1 and optional Tray 2): 250 sheets (weight: 75 g/m ² , 20 lb) Multipurpose tray: 50 sheets for plain paper (weight: 75 g/m ² , 20 lb), 5 sheets for card stock, labels, transparencies, and envelopes
Paper output capacity	Front output tray: 150 sheets (face down) Rear output slot: 1 sheet (face up)
Paper type	Paper tray: Plain paper (60 ~ 90 g/m ² , 16 ~ 24 lb) Multipurpose tray: Plain paper, Transparencies, Labels, Post card, Envelopes (60 ~ 163 g/m ² , 16 ~ 43 lb)
Consumables	1-piece toner cartridge system
Power requirements	100 - 127 VAC, 50/60 Hz, 5.0 A 220 - 240 VAC, 50/60 Hz, 2.6 A
Power consumption	Sleep mode: 30 W Max.: 420 W
Noise*	Standby mode: Less than 39 dBA Printing: Less than 54 dBA Copy: Less than 55 dBA
Warm-up time	Less than 42 seconds
Operating conditions	Temperature: 50 °F to 89 °F (10 °C to 32 °C) Humidity: 20 % to 80 % RH
LCD	16 characters x 2 lines
Toner cartridge life**	5,000 or 3,000 pages at ISO 19752 5 % coverage (Ships with 3,000 pages Start Toner Cartridge)
SET dimension (W x D x H)	450 x 435 x 457 mm
Weight	17 Kg (including consumables)
Package weight	Paper: 2.8 Kg Plastic: 0.7 Kg

Item	Description
Duty cycle (Monthly)	Print: Up to 15,000 pages Scan: Up to 1,000 pages ADF: Up to 1,000 pages

*Sound Pressure Level, ISO7779

**The number of pages may be affected by operating environment, printing interval, media type, and media size.

Scanner and Copier Specifications

Item	Description
Compatibility	TWAIN standard, WIA standard
Scanning method	ADF and Flat-bed Color CCD (Charge Coupled Device) module
Resolution	Optical: 600 x 1200 dpi (Mono and color) Enhanced: 4,800 x 4,800 dpi
Effective scanning length	Platen: 293 mm (11.5 in.) ADF: 356 mm (14 in.)
Effective scanning width	Max. 208 mm (8.2 in.)
Color bit depth	24 bit
Mono bit depth	1 bit for Text mode 8 bit for Gray mode
Copy speed*	Up to 20 pages per minute (Letter, A4)
Copy resolution	Scan: 600 x 300 dpi (Text, Mixed) / 600 x 600 dpi (Photo) Print: 600 x 600 dpi (Text, Mixed, Photo)
Zoom rate	Platen: 25 ~ 400 % ADF: 25 ~ 100 %
Multiple copies	1-99 pages
Gray scale	256 levels

*Copy Speed is based on Single Document Multiple Copy.

D

Printer Specifications

Item	Description
Printing method	Laser Beam Printing
Printing speed*	Up to 20 pages per minute (Letter, A4)
First Print Out Time	10 seconds (from Ready)
Paper size	Paper tray: Letter, A4, Legal, Folio, Executive, B5, A5 Multipurpose tray: Letter, Legal, A4, Folio, Executive, A5, A6, Envelope 10, Envelope DL, Envelope C5, Envelope C6, JIS B5, Monarch Envelope * Min.: 76 x 127 mm (3 x 5 in.) Max.: 216 x 356 (8.5 x 14 in.)
Printer resolution	Up to 1200 dpi Effective Output (Addressable 1200 x 1200dpi)
Emulation	PCL 6** Compatible
OS Compatibility***	Windows 98/Me/NT 4.0/2000/XP, Various Linux OS (USB only)
Memory	64 MB (Max. 192 MB)
	16, 32, 64, 128 MB optional memory available Use only the Samsung-approved DIMM. 16 MB: ML-00MA; 32 MB: ML-00MB; 64 MB: ML-00MC; 128 MB: ML-00MD
Interface	IEEE 1284 Parallel, USB 2.0, Ethernet 10/100 Base TX

*Print speed will be affected by operating system used, computing performance, application software, connecting method, media type, media size, and job complexity.

**Compatible with PCL6 Version 2.1

***Please visit www.samsungprinter.com to download the latest software version.

Facsimile Specifications

Item	Description
Compatibility	ITU-T Group 3
Applicable line	Public Switched Telephone Network (PSTN) or behind PABX
Data coding	MH/MR/MMR (ECM Mode) /JBIG/JPEG
Modem speed	33.6 Kbps
Transmission speed	Approx. 3 seconds/page*
Maximum document length	Platen: 297 mm ADF: 400 mm
Paper size	Letter, A4, Legal
Resolution	Standard: 203 x 98 dpi Fine: 203 x 196 dpi Super Fine: 300 x 300 dpi
User memory	4 MB (320 pages)
Halftone	256 levels
Auto dialer	One-touch dialing (up to 40 numbers) Speed dialing (up to 200 numbers))

*Transmission time applies to memory transmission of text data with ECM compression using only ITU-T No.1 Chart.

D

Paper Specifications

Overview

Your machine accepts a variety of print materials, such as cut-sheet paper (including up to 100% recycled fiber content paper), envelopes, labels, transparencies and custom-size paper. Properties, such as weight, composition, grain and moisture content, are important factors affecting the machine's performance and the output quality. Paper that does not meet the guidelines outlined in this user's guide can cause the following problems:

- Poor print quality
- Increased paper jams
- Premature wear on the machine.

NOTES:

- Some paper may meet all of the guidelines in this guide and still not produce satisfactory results. This may be the result of improper handling, unacceptable temperature and humidity levels, or other variables over which Samsung has no control.
- Before purchasing large quantities of paper, insure the paper meets the requirements specified in this user's guide.

CAUTION: Using paper that does not meet these specifications may cause problems, requiring repairs. These repairs are not covered by the Samsung warranty or service agreements.

Supported Sizes of Paper

Paper	Dimensions*	Weight	Capacity**
Letter	8.5 x 11 in. (216 x 279 mm)	<ul style="list-style-type: none"> • 60 to 90 g/m² bond (16 to 24 lb) for the paper tray • 60 to 163 g/m² bond (16 to 43 lb) for the Multipurpose tray 	<ul style="list-style-type: none"> • 250 sheets of 75 g/m² bond (20 lb) paper for the paper tray • 50 sheet of paper for the Multipurpose tray
A4	210 x 297 mm (8.3 x 11.7 in.)		
Executive	7.25 x 10.5 in. (191 x 267 mm)		
Legal	8.5 x 14 in. (216 x 356 mm)		
Folio	216 x 330 mm (8.5 x 13 in.)		
Oficio	216 x 343 mm (8.5 x 13.5 in.)		
B5 (JIS)	182 x 257 mm (7.2 x 10 in.)		
B5 (ISO)	176 x 250 mm (6.7 x 9.9 in.)		
A5	148 x 210 mm (5.8 x 8.2 in.)		
Minimum size (custom)	76 x 127 mm (3 x 5 in)	60 to 163 g/m ² bond (16 to 43 lb)	5 sheets of paper for the Multipurpose tray
Maximum size	216 x 356 mm (8.5 x 14 in)		
Transparency	Same minimum and maximum paper sizes as listed above.	138 to 148 g/m ²	
Labels		120 to 150 g/m ²	
Cards		60 to 163 g/m ²	
Envelopes		60 to 90 g/m ²	

*The machine supports a wide range of media sizes. See "Paper Type, Input Sources, and Capacities" on page 3.2.

**Capacity may differ depending on media weight, thickness, and environmental conditions.

NOTE: You may experience jams when using print materials with a length of less than 127 mm (5 in.). For optimum performance, ensure that you are storing and handling the paper correctly. Please refer to "Paper Storage Environment" on page D.9.

Guidelines for Using Paper

For the best result, use conventional 75 g/m² (20 lb) paper. Ensure that the paper is of good quality, and free of cuts, nicks, tears, spots, loose particles, dust, wrinkles, voids, and curled or bent edges.

If you are unsure of what type of paper you are loading, such as bond or recycled paper, check the label on the package.

The following problems may cause print quality deviations, jamming or even damage to the machine:

Symptom	Problem with Paper	Solution
Poor print quality or toner adhesion, problems with feeding	Too moist, too rough, too smooth or embossed; faulty paper lot	Try another kind of paper, between 100 ~ 400 Sheffield, 4 ~ 5 % moisture content.
Dropout, jamming, curl	Stored improperly	Store paper flat in its moisture-proof wrapping.
Increased gray background shading/printer wear	Too heavy	Use lighter paper, use the rear output slot.
Excessive curl problems with feeding	Too moist, wrong grain direction or short-grain construction	<ul style="list-style-type: none">• Use the rear output slot.• Use long-grain paper.
Jamming, damage to machine	Cutouts or perforations	Do not use paper with cutouts or perforations.
Problems with feeding	Ragged edges	Use good quality paper.

NOTES:

- Do not use letterhead paper printed with low-temperature inks, such as those used in some types of thermography.
- Do not use raised or embossed letterhead.
- The machine uses heat and pressure to fuse toner to the paper. Insure that any colored paper or preprinted forms use inks that are compatible with this fusing temperature (200 °C or 392 °F for 0.1 second).

Paper Specifications

Category	Specifications
Acid content	5.5 pH or lower
Caliper	0.094 ~ 0.18 mm (3.0 ~ 7.0 mils)
Curl in ream	Flat within 5 mm (0.02 in.)
Cut edge conditions	Cut with sharp blades with no visible fray.
Fusing compatibility	Must not scorch, melt, offset or release hazardous emissions when heated to 200 °C (392 °F) for 0.1 second.
Grain	Long grain
Moisture content	4 % ~ 6 % by weight
Smoothness	100 ~ 400 Sheffield

Paper Output Capacity

Output Location	Capacity
Face-down output tray	150 sheets of 75 g/m ² bond (20 lb) paper
Face-up output slot	1 sheet of 75 g/m ² bond (20 lb) paper

Paper Storage Environment

Paper storage environmental conditions directly affect the feed operation.

Ideally, the machine and paper storage environment should be at or near room temperature, and not too dry or humid. Remember that paper is hygroscopic; it absorbs and loses moisture rapidly.

Heat works with humidity to damage paper. Heat causes the moisture in paper to evaporate, while cold causes it to condense on the sheets. Heating systems and air conditioners remove most of the humidity from a room. As paper is opened and used, it loses moisture, causing streaks and smudging. Humid weather or water coolers can cause the humidity to increase in a room. As paper is opened and used it absorbs any excess moisture, causing light print and dropouts. Also, as paper loses and gains moisture it can become distorted. This can cause paper jams.

Care should be taken not to purchase more paper than can be used in a short time (about 3 months). Paper stored for long periods may experience heat and moisture

extremes, which can cause damage. Planning is important to prevent damage to large supplies of paper.

Unopened paper in sealed reams can remain stable for several months before use. Opened packages of paper have more potential for environment damage, especially if they are not wrapped with a moisture-proof barrier.

The paper storage environment should be properly maintained to ensure optimum performance. The required condition is 20 to 24 °C (68 to 75 °F), with a relative humidity of 45 % to 55 %. The following guidelines should be considered when evaluating the paper's storage environment:

- Paper should be stored at or near room temperature.
- The air should not be too dry or too humid.
- The best way to store an opened ream of paper is to rewrap it tightly in its moisture-proof wrapping. If the machine environment is subject to extremes, unwrap only the amount of paper to be used during the day's operation to prevent unwanted moisture changes.

Envelopes

Envelope construction is critical. Envelope fold lines can vary considerably, not only between manufacturers, but also within a box from the same manufacturer. Successful printing on envelopes depends upon the quality of the envelopes. When selecting envelopes, consider the following components:

- Weight: The weight of the envelope paper should not exceed 90g/m² (24lb) or jamming may occur.
- Construction: Prior to printing, envelopes should lie flat with less than 6mm (0.25in.) curl, and should not contain air.
- Condition: Envelopes should not be wrinkled, nicked or otherwise damaged.
- Temperature: You should use envelopes that are compatible with the heat and pressure of the machine.
- Size: You should only use envelopes within the following size ranges.

	Minimum	Maximum
Multipurpose tray	76 x 127 mm (3 x 5 in.)	216 x 356 mm (8.5 x 14 in.)

NOTES:

- Use only the manual feeder to print envelopes.
 - You may experience some paper jams when using any media with a length less than 140 mm (5.5 in.). This may be caused by paper that has been affected by environmental conditions. For optimum performance, make sure you are storing and handling the paper correctly. Please refer to "Paper Storage Environment" on page D.9.
-

Envelopes with Double Side Seams

Double side-seams construction has vertical seams at both ends of the envelope rather than diagonal seams. This style may be more likely to wrinkle. Be sure the seam extends all the way to the corner of the envelope as illustrated below.

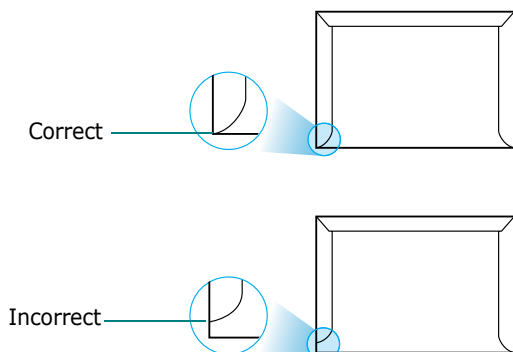

Envelopes with Adhesive Strips or Flaps

Envelopes with a peel-off adhesive strip or with more than one flap that folds over to seal must use adhesives compatible with the heat and pressure in the machine. The extra flaps and strips might cause wrinkling, creasing or even jams and may even damage the fuser.

Envelope Margins

The following gives typical address margins for a commercial #10 or DL envelope.

Type of Address	Minimum	Maximum
Return address	15 mm (0.6 in.)	51 mm (2 in.)
Delivery address	51 mm (2 in.)	90 mm (3.5 in.)

NOTES:

- For the best print quality, position margins no closer than 15 mm (0.6 in.) from the edges of the envelope.
- Avoid printing over the area where the envelope's seams meet.

Envelope Storage

Proper storage of envelopes helps contribute to print quality. Envelopes should be stored flat. If air is trapped in an envelope, creating an air bubble, then the envelope may wrinkle during printing.

Labels

CAUTIONS:

- To avoid damaging the machine, use only labels recommended for laser printers.
 - To prevent serious jams, always use the manual feeder to print labels and always use the rear output tray.
 - Never print on the same sheet of labels more than once and never print on a partial sheet of labels.
-

When selecting labels, consider the quality of each component:

- Adhesives: The adhesive material should be stable at 180°C (356°F), the machine's fusing temperature.
- Arrangement: Only use labels with no exposed backing between them. Labels can peel off sheets with spaces between the labels, causing serious jams.
- Curl: Prior to printing, labels must lie flat with no more than 13mm (5in.) of curl in any direction.
- Condition: Do not use labels with wrinkles, bubbles or other indications of separation.

Transparencies

Transparencies used in the machine must be able to withstand 180°C (356°F), the machine's fusing temperature.

CAUTION: To avoid damaging the machine, use only transparencies recommended for use in laser printers.



INDEX

Numerics

- 2/4-up, special copy 5.12
- 2-side, special copy 5.11

A

- adding documents 7.32
- ADF (Automatic Document Feeder), load 5.5, 7.6
- ADF rubber pad, replace 8.14
- auto fit, special copy 5.11
- automatic dialing
 - group 7.23
 - one-touch 7.19
 - speed 7.21
- automatic redialing 7.13

B

- broadcasting faxes 7.28

C

- canceling
 - copy 5.5
 - fax 7.12
 - print 4.3
 - scan 6.6, 6.8
 - scheduled faxes 7.33
- CCD power save mode, use 2.25
- characters, enter 2.17
- cleaning
 - drum 8.10
 - inside 8.3
 - LSU 8.4
 - outside 8.3
 - scan unit 8.5
- clone, special copy 5.10
- collation, special copy 5.10
- components 1.4

connection

- AC power 2.14
- extension phone 2.11
- parallel 2.13
- telephone line cord 2.11
- USB 2.12
- consumables 8.13
- contrast, copy 5.7
- control panel 1.6
- copying
 - collation 5.10
 - contrast 5.7
 - default setting, change 5.14
 - from ADF 5.5
 - from document glass 5.4
 - number of pages 5.9
 - original type 5.7
 - time out, set 5.15

D

- date and time, set 2.19
- delayed fax 7.29
- DIMM
 - installing C.2
 - removing C.4
- display language, change 2.15
- document
 - jam, clear 9.2
 - loading
 - ADF 5.5, 7.6
 - document glass 5.4, 7.7
 - preparing 5.3
- document glass
 - cleaning 8.5
 - loading 7.7
- DRPD (Distinctive Ring Pattern Detection) 7.17
- drum, clean 8.10

E

- error messages 9.12
- extension phone, connect 2.11

F

- Favorite setting, use 4.12
- fax system, set
 - advanced settings 7.37
 - basic settings 7.3
- fit to page
 - copying 5.11
 - printing 4.16
- front output tray, use 3.10

G

- graphic properties, set 4.8
- group dial
 - dialing 7.25
 - editing 7.24
 - setting 7.23

H

- help, use 4.12

I

- image mode 4.8
- installing
 - Linux software A.3
 - Local printing 2.29
 - Custom Installation 2.31
 - Typical Installation 2.29
 - Memory C.2
 - Network printing 2.34
 - Custom Installation 2.37
 - Typical Installation 2.34
 - optional Tray2 C.5
 - toner cartridge 2.5
 - Windows software 2.28

J

- jam, clear
 - document 9.2
 - paper 9.5

L

- Linux
 - common problems 9.28
 - driver, install A.4
 - printer properties A.11
 - printing A.12
 - scanning A.14
- loading, paper
 - in the multipurpose tray 3.6
 - in the paper tray 2.7
 - using the manual feed 3.8

M

- machine ID, set 2.16
- manual feed mode, use 3.8
- memory DIMM
 - installing C.2
 - removing C.4
- memory, clear 8.2
- MFP driver, install
 - Linux A.4
 - Windows 2.28
- multipurpose tray, use 3.6

N

- network printing
 - locally shared printer, set B.3
 - network-connected printer, set B.5
 - parameters, configure B.5
- Network Scan 6.9
- Network Scan Driver
 - uninstalling 2.44
- notifying toner low 8.10
- n-up (multiple pages per sheet)
 - copying 5.12
 - printing 4.13

O

- one-touch dial
 - dialing 7.20
 - storing 7.19
- option, install
 - memory DIMM C.2
 - paper tray 2 C.5
- orientation, print 4.5, A.13
- output location, select 3.10
- overlay, use 4.21

P

- paper guidelines 3.3
- paper jam, clear 9.5
- paper level indicator 3.5
- paper load
 - in manual feeder 3.8
 - in paper tray 2.7
 - in the multipurpose tray 3.6
- paper load capacity 3.2
- paper size, set
 - paper tray 2.20
 - print 4.6, A.13
- paper source, set 4.7, A.13
- paper type, set
 - paper tray 2.20
 - print 4.7, A.13
- parallel, connect 3.7
- poster
 - copying 5.13
 - printing 4.14
- power save mode, use 2.24
- print order, set 4.11
- print quality problems, solve 9.19
- print resolution 4.8, A.13
- printer driver, install
 - Linux A.4
 - Windows 2.28
- printer properties
 - Linux A.12
 - Windows 4.4
- Printer Settings Utility
 - installing 2.29
 - starting 2.45
 - tabs 2.46
 - uninstalling 2.43
- printing
 - fitting to a selected paper size 4.16
 - from Linux A.12
 - from Windows 4.2
 - multiple pages on one sheet 4.13
 - Phonebook list 7.27
 - posters 4.14
 - reduced or enlarged document 4.17
 - reports 7.35
 - using overlays 4.21
 - watermarks 4.18
- priority fax 7.31
- problem, solve
 - copying 9.24
 - error messages 9.12
 - faxing 9.26
 - Linux 9.28

- paper feeding 9.16
- printing 9.17
- printing quality 9.19
- scanning 9.25

R

- rear output slot, use 3.11
- receive mode, set 7.3
- receiving a fax
 - in Ans/Fax mode 7.16
 - in DRPD mode 7.17
 - in Fax mode 7.15
 - in Secure Receiving mode 7.34
 - in Tel mode 7.15
 - in the memory 7.18
- redialing
 - automatically 7.13
 - manually 7.12
- reduced/enlarged
 - copying 5.8
 - printing 4.17
- replacing
 - ADF rubber pad 8.14
 - toner cartridge 8.8
- reports, print 7.35
- resolution
 - faxing 7.9
 - printing 4.8, A.13

S

- scanning
 - control panel 6.3
 - Linux A.14
 - SmarThru 6.4
 - USB flash drive 10.3
 - WIA driver 6.7
- searching Phonebook 7.26
- Secure Receiving mode 7.34
- sending a fax
 - automatically 7.11
 - manually 7.12
- sharing printer, set B.3
- SmarThru
 - install 2.28
 - uninstall 2.44
- software
 - uninstall
 - Windows 2.43
- sounds, set 2.21

- specifications
 - facsimile D.5
 - general D.2
 - paper D.6
 - printer D.4
 - scanner and copier D.3
- speed dial
 - dialing 7.22
 - storing 7.21
- system requirements
 - Linux A.3
 - Windows 2.28

T

- tel line, connect 2.11
- toll save mode, use 2.23
- toner cartridge
 - installing 2.5
 - maintaining 8.6
 - redistributing 8.7
 - replacing 8.8
- toner save mode, use 2.23

U

- uninstall, software
 - Windows 2.43
- uninstalling
 - MFP driver
 - Linux A.6
 - Windows 2.43, 2.44
 - SmarThru 2.44
- USB
 - connecting 3.7
- USB flash drive
 - installing 10.2
 - managing 10.6
 - printing 10.10
 - scanning 10.3

V

- volume, adjust
 - ringer 2.21
 - speaker 2.22

W

- watermarks, use 4.18



Home

Visit us at:

www.samsungprinter.com

Rev. 2.00