

UPDATE

5/7/03

This package provides a new ink jet printer product section to be added to the *EPSON Product Information Guide*. The table of contents of this section is listed below.

EPSON Stylus® Photo 900

TABLE OF CONTENTS

User Replaceable Parts.....	EPSON Stylus Photo 900 - 1
Accessories.....	EPSON Stylus Photo 900 - 1
Printer Specifications.....	EPSON Stylus Photo 900 - 2
Control Panel.....	EPSON Stylus Photo 900 - 3
Installing the First Ink Cartridges.....	EPSON Stylus Photo 900 - 4
Replacing an Ink Cartridge.....	EPSON Stylus Photo 900 - 5
Selecting the Paper Type Setting.....	EPSON Stylus Photo 900 - 6
Paper Loading Guidelines.....	EPSON Stylus Photo 900 - 7
Loading Roll Paper.....	EPSON Stylus Photo 900 - 7
Loading and Printing CDs and DVDs.....	EPSON Stylus Photo 900 - 9
Cleaning the Print Head.....	EPSON Stylus Photo 900 - 11
Aligning the Print Head.....	EPSON Stylus Photo 900 - 12
Cleaning the Printer.....	EPSON Stylus Photo 900 - 13
Transporting the Printer.....	EPSON Stylus Photo 900 - 14
Related Documentation.....	EPSON Stylus Photo 900 - 14

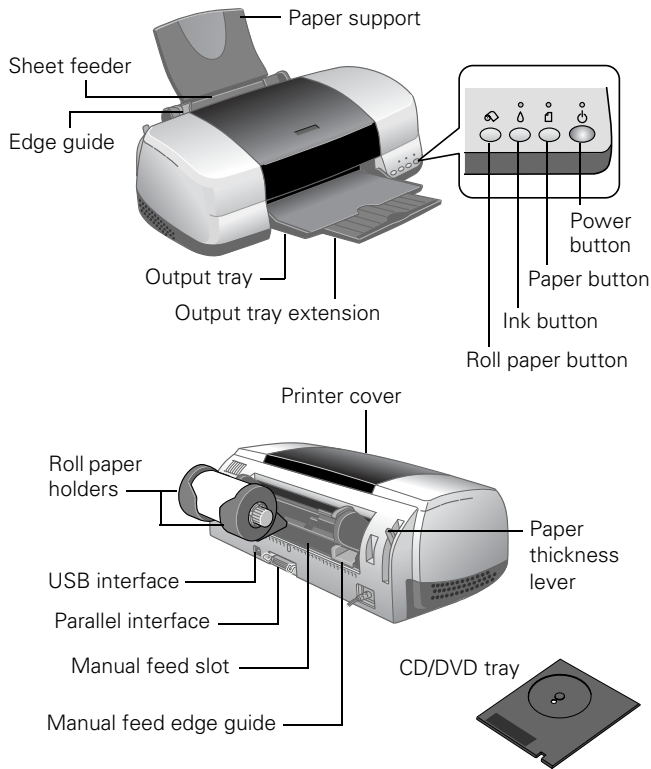

EPSON Media

Paper name*	Size	Part number
EPSON Premium Bright White Paper	Letter (8.5 x 11 inches)	S041586
EPSON Photo Quality Ink Jet Paper	Letter (8.5 x 11 inches)	S041062
	A4 (8.3 x 11.7 inches)	S041061
	Legal (8.5 x 14 inches)	S041067
EPSON Photo Quality Ink Jet Cards	A6 (4.1 x 5.8 inches)	S041054
EPSON Glossy Photo Paper or EPSON Photo Paper	Letter (8.5 x 11 inches)	S041141/S041649/ S041271/ S041272
	A4 (8.3 x 11.7 inches)	S041140
	Panoramic (8.3 x 23.4 inches)	S041145
EPSON Matte Paper Heavyweight	8 x 10 inches, Borderless	S041467
	Letter (8.5 x 11 inches)	S041257
Double-Sided Matte Paper	Letter (8.5 x 11 inches)	S041568
EPSON Premium Glossy Photo Paper	4 x 6 inches, Borderless	S041682
	5 x 7 inches, Borderless	S041464
	8 x 10 inches, Borderless	S041465
	Letter (8.5 x 11 inches)	S041286/S041667
	Roll (4 inches x 26 feet)	S041302
	Roll (8.3 inches x 32.8 feet)	S041376
EPSON Premium Semigloss Photo Paper	Letter (8.5 x 11 inches)	S041331
	Roll (4 inches x 26 feet)	S041329
EPSON Premium Luster Photo Paper	Letter (8.5 x 11 inches)	S041405
	Roll (8.3 inches x 32.8 feet)	S041408
EPSON ColorLife™ Photo Paper	Letter (8.5 x 11 inches)	S041500
EPSON Ink Jet Transparencies	Letter (8.5 x 11 inches)	S041064
EPSON Iron-On Transfer Paper	Letter (8.5 x 11 inches)	S041153/S041155
EPSON Photo Quality Self Adhesive Sheets	A4 (8.3 x 11.7 inches)	S041106
EPSON Photo Stickers® Kit	A6 (4.1 x 5.8 inches)	S041144-KIT
EPSON Photo Stickers Refill	A6 (4.1 x 5.8 inches)	S041144
EPSON Glossy Photo Greeting Cards	Letter (8.5 x 11 inches); perforated edges	S041606

User Replaceable Parts

User replaceable part	Reference number	Part number
Printer cover	110	1234191
Paper support	808	1214028
Logo plate	—	1213549
Left roll paper holder	801	1249724
Right roll paper holder	802	1249725
CD-ROM/DVD tray	806	1218228

Accessories

Ink Cartridges

Cartridge	Part number
Black	T007201
Color	T009201



To ensure good results, use genuine EPSON cartridges and do not refill them. Other products may cause damage to your printer not covered by EPSON's warranties.

Don't use an ink cartridge beyond the expiration date on the package.

* Availability of paper types varies by location

Printer Specifications

Printing

Printing method	On-demand ink jet
Nozzle Configuration	48 nozzles (each color) × 6 Black, cyan, magenta, yellow, light cyan, light magenta
Resolution	Maximum 5760 × 720 optimized dpi
Print direction	Bidirectional with logic seeking
Control code	EPSON ESC/P® Raster, EPSON Remote
Input buffer	32 KB
Interfaces	USB and bi-directional IEEE 1284

Mechanical

Paper feed	Friction
Paper path	Sheet feeder, top entry
Sheet feeder capacity	100 sheets of 17 lb (65 g/m ²) paper
Dimensions	
Storage	Width: 19.4 inches (493 mm) Depth: 12.0 inches (305 mm) Height: 7.2 inches (183 mm)
Printing	Width: 19.4 inches (493 mm) Depth: 21.5 inches (546 mm) Height: 11.9 inches (302 mm)
Weight	15.2 lb (6.9 kg) without ink cartridges

Ink Cartridges

Colors	Black, cyan, magenta, yellow, light cyan light magenta
Print capacity	
Black	540 pages (A4, ISO/IEC 10561 Letter Pattern at 360 dpi, 5% coverage)
Color	330 pages (A4, 360 dpi, 15% coverage)
Cartridge life	2 years from production date (if unopened); within 6 months after opening package, at 77 °F (25 °C)
Dimensions (W × D × H)	
Black	0.8 × 2.4 × 1.5 inches (20.1 × 60 × 38.5 mm)
Color	1.9 × 3.3 × 1.6 inches (49.1 × 84.05 × 41.8 mm)

Storage temperature	−4 to 104 °F (−20 to 40 °C) 1 month at 104 °F (40 °C)
---------------------	--

Transit temperature	−22 to 140 °F (−30 to 60 °C) 1 month at 104 °F (40 °C) 20 hours at 140 °F (60 °C)
---------------------	---

Freezing temperature**

Black	3.2 °F (−16 °C)
Color	−0.4 °F (−18 °C)

* The figure given is based on continuous printing after ink replacement. The actual print capacity may vary.

** Ink thaws and is usable after approximately 3 hours at 77 °F (25 °C)



To ensure good results, use genuine EPSON cartridges and do not refill them. Other products may cause damage to your printer not covered by EPSON's warranties. Don't use an ink cartridge beyond the expiration date on the package.

Electrical

Specification	120 V model	220-240 V model
Rated voltage	120 V	240 V
Input voltage range*	99 to 132 V	198 to 264 V
Rated frequency range	50 to 60 Hz	
Input frequency range	49.5 to 60.5 Hz	
Rated current	0.3 A (max 0.5 A)	0.2 A (max 0.3 A)
Power consumption	Approx. 12 W (ISO 10561 Letter Pattern)	
	Approx. 5 W in sleep mode	Approx. 5.5 W in sleep mode
	Approx. 0.2 W in standby mode	Approx. 0.3 W in standby mode

* Check the label on the back of the printer for its voltage.

Environmental

Temperature	
Operation	50 to 95 °F (10 to 35 °C)
Storage*	−4 to 104 °F (−20 to 40 °C) 1 month at 104 °F (40 °C)
Transit*	−4 to 140 °F (−20 to 60 °C) 120 hours at 140 °F (60 °C)

Humidity (without condensation)

Operation	20 to 80% RH
Storage*	5 to 85% RH

* Stored in shipping container

Safety Approvals

Safety standards UL 60950, CSA C22.2 No. 60950

EMC FCC part 15 Subpart B Class B
CSA C108.8 Class B

Paper

Paper	Type	Thickness	Weight
Single sheets and roll paper	Plain, bond, and special ink jet papers distributed by EPSON	0.003 to 0.051 inch (0.08 to 1.3 mm) for plain bond paper	17 to 24 lb (64 to 90 g/m ²) for plain bond paper
Envelopes	Plain, bond, or air mail paper	0.006 to 0.02 inch (0.16 to 0.52 mm)	12 to 20 lb (45 to 75 g/m ²)

Printable area

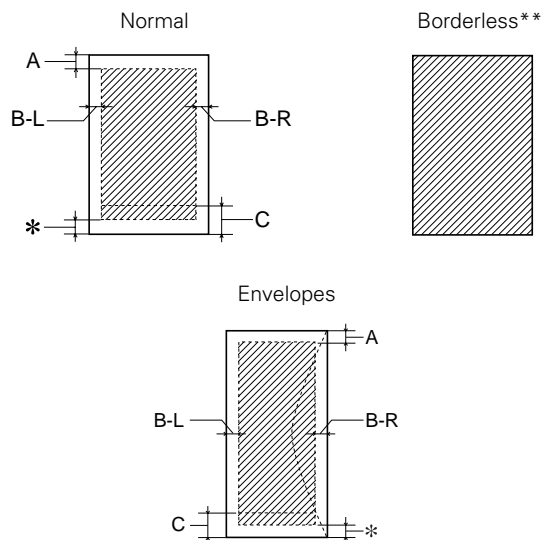

A	The minimum top margin is 0.12" (3.0 mm).
B-L	The minimum left margin is 0.12" (3.0 mm).
B-R	The minimum right margin is 0.12" (3.0 mm).
C	The minimum bottom margin is 0.55" (14 mm).

* You can extend the minimum bottom margin to 0.12" (3 mm) using the maximize (Windows) or minimize (Macintosh) margins feature; however, print quality may decline in the expanded area. Before printing large jobs using an extended margin setting, print a single sheet to confirm printout quality.

** When printing with the borderless feature, print quality may decline in the expanded area. Before printing large jobs using the borderless setting, print a single sheet to confirm printout quality.

Note: Always load paper into the sheet feeder with the short edge first. Load envelopes flap edge left with the flap side down.

Control Panel

To diagnose problems, check the printer's control panel, as described below, or run a nozzle check (described on page 11).

Lights	Explanation
Green power light flashes	The printer is receiving a print job, replacing an ink cartridge, charging ink, or cleaning the print head.
Red paper light is on	Your paper ran out. Load more paper and press the paper button.
Red paper light flashes	Paper is jammed in the printer. Press the paper button to eject the jammed paper. If the light is still flashing, open the cover and remove all paper, including any jammed or torn pieces. Then reload paper and press the paper button to continue printing. You can also set the paper thickness lever to the position, pull the jammed paper out, then return the lever to the position. If you're using roll paper, press the roll paper button. If the roll paper is jammed, you may need to remove the paper, then reload it to continue printing (see page 7).
Red paper light flashes quickly	The paper thickness lever is set incorrectly. Set the paper thickness lever to the correct setting for the paper that you loaded in the printer. See your <i>Printer Basics</i> book for instructions.
Red ink light flashes	One of the cartridges is low on ink. Check the message that appears on your screen to determine which cartridge is low or follow the instructions on page 5. Make sure you have a replacement cartridge.
Red ink light is on	One of the cartridges is out of ink or not installed. Make sure you have a replacement cartridge, then follow the steps on page 5 to install it. If you have just installed a new cartridge, it may be incompatible with the printer or incorrectly installed. Reinstall it or replace it with the correct cartridge, as described on page 5.
Green power light and red ink light are on	One or both of the ink cartridges is not installed correctly. Reinstall it as described on page 5.
Green power light is off; red paper and red ink lights are flashing alternately	Paper may be blocking movement of the print head. Turn off the printer, then open the cover and remove any jammed paper or other foreign objects. Turn the printer back on again. If the lights are still on, contact your dealer or EPSON as described in your <i>Printer Basics</i> book.
Green power light is off; red paper and red ink lights are flashing	The printer may have an internal error. Turn off the printer, wait a few seconds, and turn it on again. If the lights are still flashing, contact your dealer or EPSON as described in your <i>Printer Basics</i> book.

Installing the First Ink Cartridges

1. Open the output tray and the printer cover.

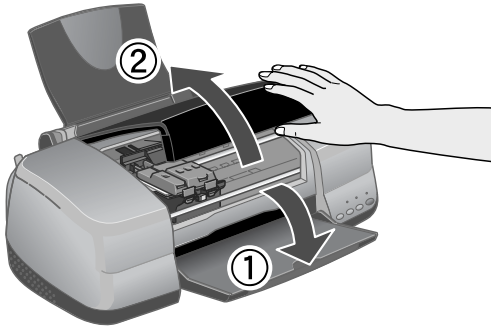

2. Lift up both ink cartridge clamps.

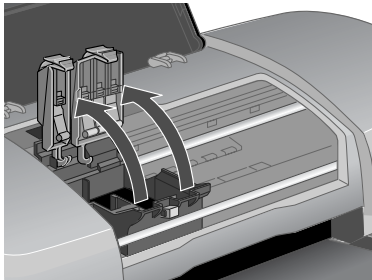

3. Unwrap the ink cartridges and remove the yellow tape.

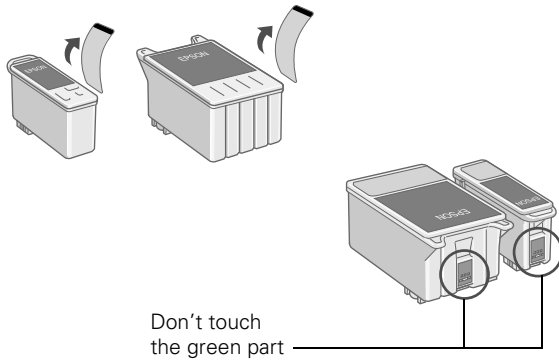

4. Lower each cartridge into the holder. Make sure the tabs rest on the hooks in the back.

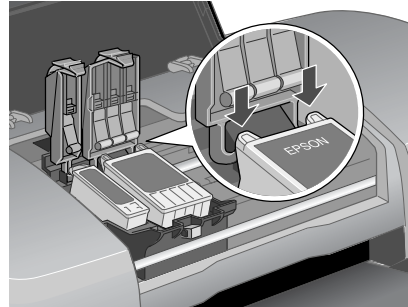

You must install both cartridges or the printer won't work.

5. Press down on the ink cartridge clamps until they click into place.

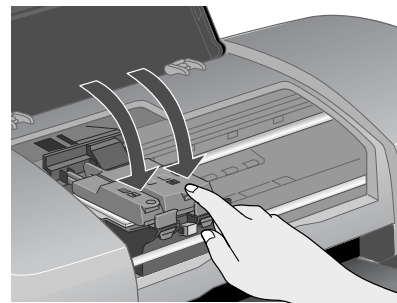

6. Close the printer cover and press the Δ ink button. The green Δ power light flashes as the printer charges ink for about 2 minutes.



Don't turn off the printer or interrupt charging while the power light is flashing or you'll waste ink.

Replacing an Ink Cartridge

When the red Δ ink light flashes, one or more ink cartridges are low on ink. When the red Δ ink light stays on, you need to replace the cartridge(s).

When you print, you'll also see a message on your screen telling you which cartridge is low or empty.

When a cartridge is more than six months old, you may need to replace it if printouts don't look their best. If the quality doesn't improve after cleaning and aligning the print head, you can replace the cartridge even if the red Δ ink light is off.

Checking the Ink Supply

To check your ink supply, do the following:

- Windows:** Double-click the  icon on the Windows taskbar. You see a window like this:

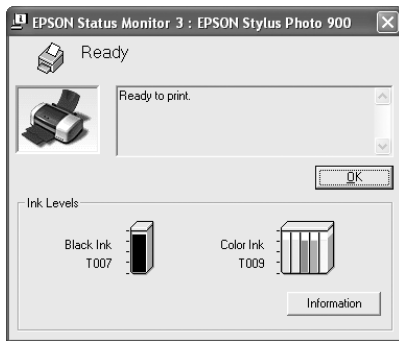

- Macintosh OS 8.6 to 9.x:** From the File menu, select Print, then click the  ink icon.
- Macintosh OS X:** Choose Applications > EPSON Printer Utility > SP 900 > Status Monitor.

You see a window like this:

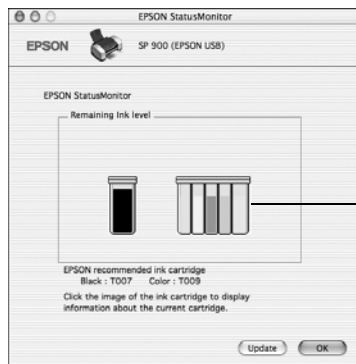

Click a cartridge image to display information about the cartridge.

Ink Cartridge Precautions



Keep ink cartridges out of the reach of children.

If ink gets on your hands, wash them thoroughly with soap and water. If ink gets in your eyes, flush them thoroughly with water.



To avoid damaging the printer, never move the print head by hand.

You cannot print if an ink cartridge is empty. Leave the empty cartridge installed in the printer until you have obtained a replacement. Otherwise the ink remaining in the print head nozzles may dry out.

Removing and Installing Ink Cartridges

Be sure you have a new ink cartridge before you begin. Once you start replacing a cartridge, you must complete all the steps in one session.

1. Make sure the printer is turned on (the green \odot power light should be on, but not flashing). Then open the printer cover.
2. Press and release the Δ ink button. The print head moves to the ink cartridge replacement position.

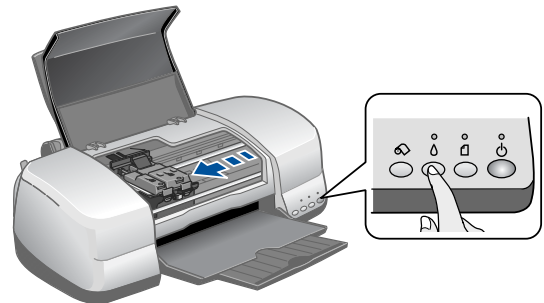

The red Δ light also begins to flash or remains on.

- If it flashes at the same speed as the green \odot light, replace the black cartridge.
- If it flashes twice as fast as the green \odot light, replace the color ink cartridge.
- If it remains on, replace both cartridges.

Note: You can also use the Status Monitor to find out which cartridge is out of ink. See "Checking the Ink Supply" on this page for more information.

The color cartridge is on the right and the black is on the left.

- Pull up the ink cartridge clamp. The cartridge rises up from its holder.

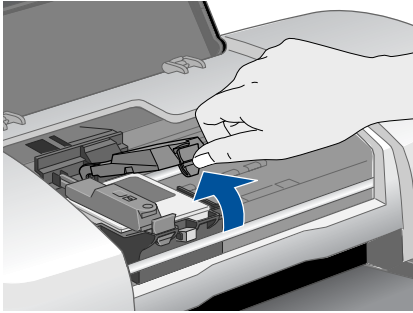

- Lift the cartridge out of the printer and dispose of it carefully.
- Remove the new cartridge from its package. Then remove *only* the yellow tape seal on top.



Don't touch the green circuit board on the back of the cartridge; you may inhibit normal operation and printing.

- Lower the new cartridge down into the holder. Make sure the tabs rest on the hooks in back.

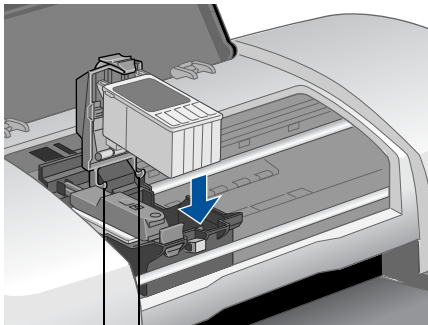

Hooks



Don't place the cartridge tabs under the hooks; you may damage the clamp when you close it.

- Press down firmly on the ink cartridge clamp until it snaps in place.
- If you need to replace the other ink cartridge, repeat steps 3 through 7 before continuing with step 9.

- Close the printer cover and press the Δ ink button. The printer begins charging the ink delivery system.

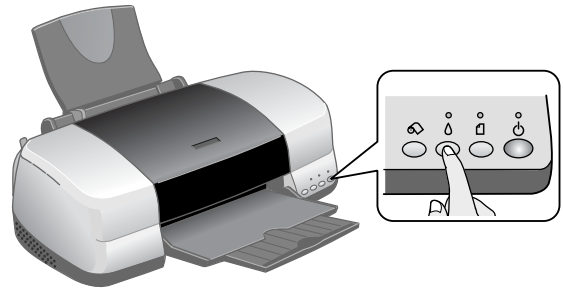

The green Δ power light flashes and the printer makes noise. Charging takes about half a minute. When it's finished, the green Δ power light stops flashing and stays on, and the red Δ light goes out.



Never turn off the printer while the green Δ power light is flashing, unless the printer hasn't moved or made noise for more than 5 minutes.

Selecting the Paper Type Setting

Select the correct **Type** or **Media Type** setting so your printer knows what kind of paper you're using and adjusts the ink coverage accordingly.

For this paper	Select this paper Type or Media Type setting
Plain paper sheets or envelopes EPSON Premium Bright White Paper	Plain paper
EPSON Iron-On Transfer Paper	360 dpi Ink Jet Paper
EPSON Photo Quality Ink Jet Paper EPSON Photo Quality Ink Jet Cards EPSON Photo Quality Self Adhesive Sheets	Photo Quality Ink Jet Paper
EPSON Matte Paper Heavyweight EPSON Double-Sided Matte Paper	Matte Paper - Heavyweight
EPSON Photo Paper EPSON Panoramic Photo Paper	Photo Paper
EPSON Glossy Photo Paper EPSON Photo Quality Glossy Paper EPSON Glossy Photo Greeting Cards	Glossy Photo Paper
EPSON Premium Glossy Photo Paper	Premium Glossy Photo Paper
EPSON Premium Luster Photo Paper	Premium Luster Photo Paper
EPSON Premium Semigloss Photo Paper	Premium Semigloss Photo Paper
EPSON Photo Stickers	Photo Quality Glossy Film
EPSON ColorLife Photo Paper	ColorLife Photo Paper
EPSON Ink Jet Transparencies	Ink Jet Transparencies

Paper Loading Guidelines

You can load the following number of sheets of EPSON special media:

Paper type	Loading capacity
Premium Bright White Paper	100 Sheets
Photo Quality Ink Jet Paper	65 sheets
Photo Quality Ink Jet Cards	30 cards with a support sheet beneath the stack
Glossy Photo Paper or Photo Paper	20 sheets
Panoramic Photo Paper	1 sheet with a support sheet beneath the sheet
Matte Paper Heavyweight	20 sheets with a support sheet beneath the stack
ColorLife Photo Paper	1 sheet with a support sheet beneath the sheet
Double-Sided Matte Paper Premium Glossy Photo Paper Premium Semigloss Photo Paper Premium Luster Photo Paper Ink Jet Transparencies Iron-On Transfer Paper Photo Stickers Photo Quality Self Adhesive sheets Glossy Photo Greeting Cards	1 sheet

- Load all paper with the printable side up. It's usually whiter or brighter than the other side.
- If the paper has a cut corner, position it in the upper right corner as you load it in the sheet feeder.
- Check the paper package for additional instructions on using special papers.
- Load envelopes 10 at a time and set the paper thickness lever to the position.

Loading Roll Paper

You can load the following types and sizes of roll paper:

Paper name	Roll sizes
EPSON Premium Glossy Photo Paper	4 inches × 26 feet 8.3 inches (A4) × 32.8 feet
EPSON Premium Semigloss Photo Paper	4 inches × 26 feet
EPSON Premium Luster Photo Paper	8.3 inches (A4) × 32.8 feet

1. Remove the tape and protective paper from the end of the roll. Then insert the holders into the roll of paper as shown.

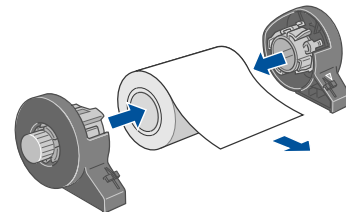

2. Make sure the end of the paper is cut straight across, with 90° corners. If the end is cut diagonally, you may have problems feeding the paper.
3. If the paper curls at the end, fold a sheet of paper over the end and roll it backward to uncurl it.

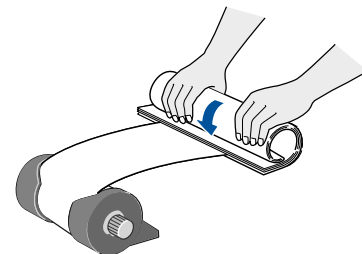

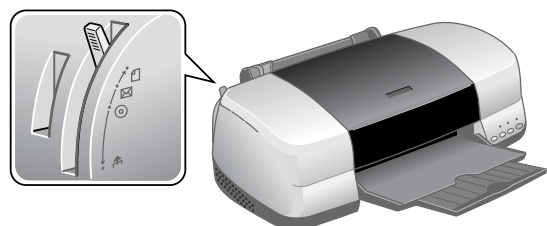

Avoid touching the printable surface of the roll paper.

4. Remove any paper that's in the sheet feeder at the top of the printer. Then remove the paper support, lower the output tray, and turn on the printer.
5. Make sure the paper thickness lever is set to the position.

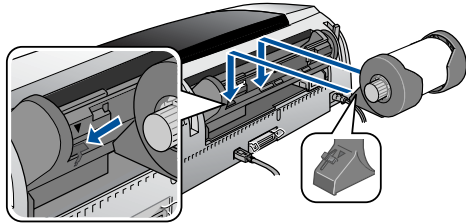

6. Install the roll paper holders on the printer. Insert the left holder into the far left slot, then insert the other holder into the appropriate slot on the right (either the 4-inch slot as shown, or the 8.3-inch slot further on the right).



7. Pull out approximately six inches of paper and insert it into the sheet feeder. Then slide the left edge guide against the paper (but not too tightly).
8. Hold the paper in place by the edges and press the  roll paper button until the printer feeds the paper automatically.

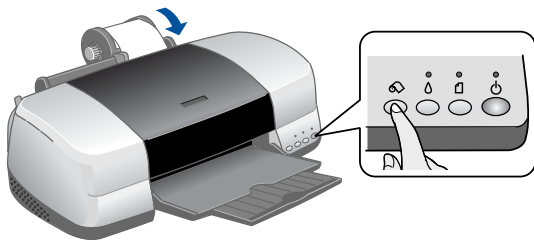

9. To verify that the paper is loaded straight, open the printer cover and look into the printer.
If the paper is crooked, press the  roll paper button and hold it for three seconds to back the paper all the way out.

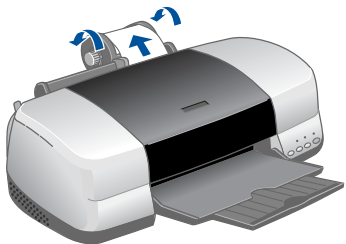



Then turn the roll paper holder knobs to roll up the paper. Press the  roll paper button to clear the paper out error. Repeat steps 7 through 9 to reload the paper.

Loading and Printing on Card Stock or Matte Board

You can use the manual feed slot in the back of the printer to print on white card stock or matte board up to 1.3 mm (0.051 inch or 51 mil) thick, in the following sizes: letter, legal, or A4 size.

Before you start, remove the paper support. Then turn the printer on. (The printer must be on to load card stock correctly.)

1. Push in the output tray extension, but leave the tray open.
2. Set the paper thickness lever to the  position. The  paper light begins flashing rapidly.

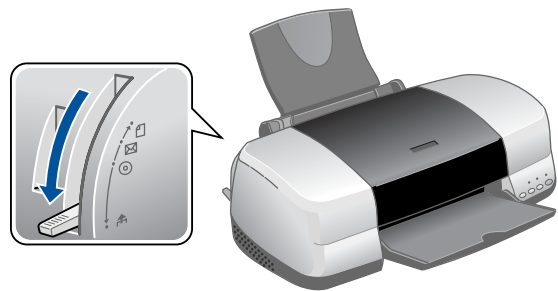

3. Slide the edge guide to the right to make room for the card stock.

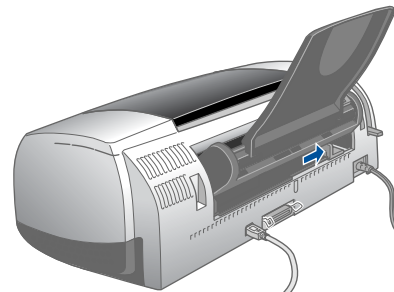

4. Open the printer cover and place a sheet of card stock against the left side of the manual feed slot, with the side you want to print on facing up.

- Slide the card stock into the printer until the leading edge is 1 cm (0.4 inches) from the gray rollers.

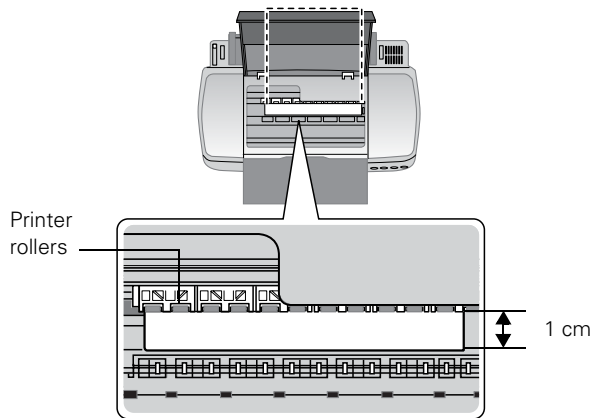

- Slide the edge guide against the card stock.

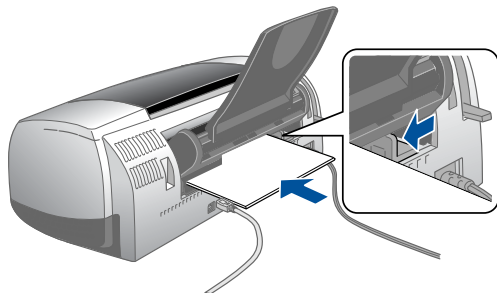

- Set the paper thickness lever to the position. (If the print quality is not satisfactory, try setting the paper thickness lever to the position for the next print.)

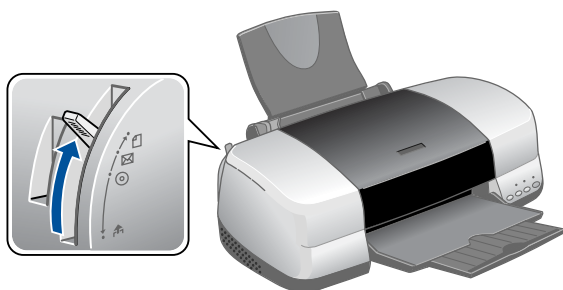

If you're using the manual feed slot to print on paper rather than card stock, set the paper thickness lever to the position.

- Close the printer cover and press the button to feed the card stock into the printer.

Note: If the paper light flashes, make sure the paper thickness lever is set correctly, then press the button again.

- Before you print, make sure you select **Manual** or **Manual Feed** as the paper source in your printer software. (See the *Printer Basics* manual for instructions.)

When you're finished printing on card stock, make sure you return the paper thickness lever to the position.



Don't move the paper thickness lever during printing; this could damage your printer.

Loading and Printing CDs and DVDs

Follow the instructions in this section to load an ink-jet printable CD or DVD on the printer's special tray and print it. You can print on both regular 12-cm CDs and 8-cm mini CDs.



Thermal printable CDs and DVDs should not be used with this printer.

Ink-jet printable CDs and DVDs can be ordered from several websites, for example, www.pcmall.com, www.cdw.com, www.warehouse.com, www.zones.com, and www.pcconnection.com.

Make sure the data, music, or video is burned on your CDs or DVDs before you print. Otherwise, dirt or scratches on the surface may cause errors when you burn the data. If you plan to print large numbers of CDs or DVDs, it's a good idea to print a small sample, then wait a day and check the quality to make sure it is satisfactory.

Cleaning the Roller

Before you print on a CD or DVD, clean the roller inside the printer by feeding and ejecting several sheets of plain paper:



- Make sure the printer is turned on and letter-size paper is loaded.
- Press the paper button to feed the paper into the printer.
- Press the paper button again to eject the paper.
- Repeat steps 2 and 3 several times.

Designing CDs and DVDs

You can use the EPSON Print CD program (included on the Printer Software CD-ROM) to create and print a design with images, graphics, and text. See the *Printer Basics* manual for instructions.

Inserting the Disc

Before you insert a CD or DVD, make sure the printer is turned on. Otherwise, the disc may not be positioned correctly.

1. Push in the output tray extension, but leave the tray open.
2. Set the paper thickness lever to the  position. The  paper light begins flashing rapidly.

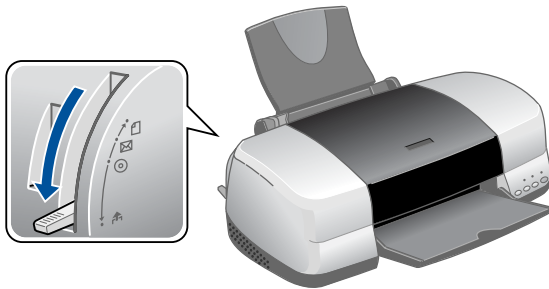

3. Place the CD or DVD on the CD tray with the white or printable side face up.

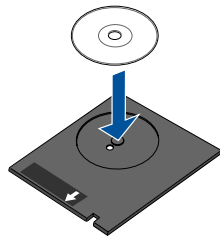

4. Slide the edge guide to the right to make room for the tray.

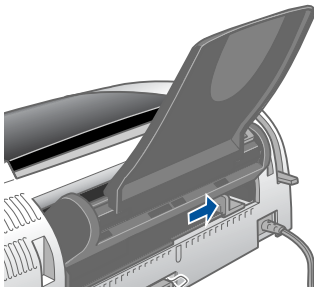

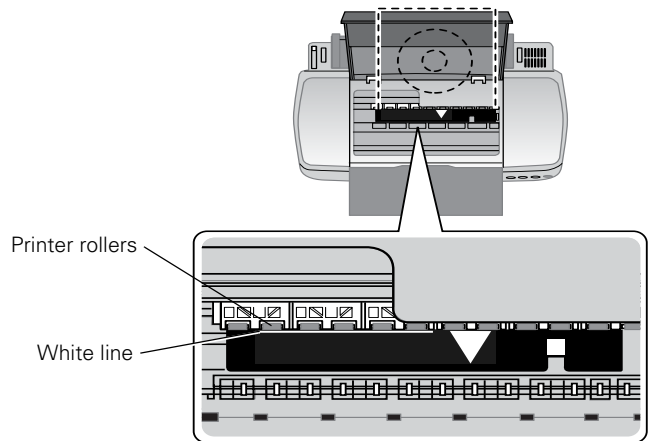

5. Insert the tray against the left side of the feeder.

6. Open the printer cover and push the tray into the printer, aligning the white line on the tray with the edges of the printer rollers.

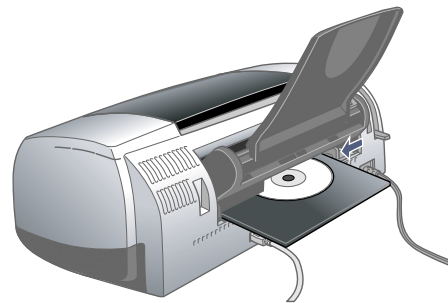

7. Slide the edge guide against the tray.



8. Set the paper thickness lever to the  position. The  paper light goes out.

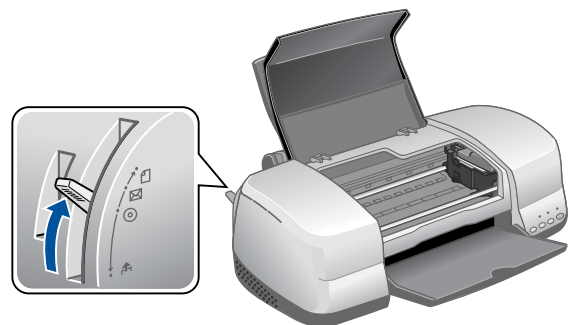

9. Close the printer cover and follow the instructions in the next section to print the CD or DVD.

Printing the CD or DVD

1. Open the File menu and select **Printer Settings** (Windows) or **Page Setup** (Macintosh).
2. Make sure your EPSON Stylus Photo 900 is selected, and the Paper Source is set to **Manual** or **Manual Feed**.
3. If you are not printing from the EPSON Print CD program, be sure to select **CD/DVD** for the **Type** setting in the printer driver.
4. Click **OK**.
5. Open the File menu and select **Print**, or click the  **Print** button.
6. Click **OK** (Windows) or **Print** (Macintosh).

Note: After you print, handle the CD or DVD carefully to avoid smearing the ink. Wait at least 24 hours before playing the disc or inserting it in a drive. Keep printed discs away from moisture and direct sunlight.

When you're finished printing on CDs and DVDs, make sure you return the paper thickness lever to the  position.





Don't move the paper thickness lever during printing; this could damage your printer.

If you want to check the print position or color, see the instructions for **Adjusting the Print Position** and **Adjusting the Print Density** in the *Printer Basics* manual.

Cleaning the Print Head

If your printouts are unexpectedly light, or dots or lines are missing, you may need to clean the print head. This unclogs the nozzles so they can deliver ink properly. Print head cleaning uses ink, however, so clean it only if quality declines.



This section explains how to clean the print head using the Head Cleaning utility.



You can also clean the print head by holding down the  button on the printer for three seconds. (This only works when the red  light is off.)



When you don't turn on your printer for a long time, print quality can decline, so turn it on and print a few pages at least once a month to maintain good print quality.

Running the Head Cleaning Utility

1. Make sure the printer is turned on but not printing, and the red  ink light is off. (If the  ink light is flashing or on, you need to replace a cartridge; see "Removing and Installing Ink Cartridges" on page 5 for details.)
2. **Windows:** Right-click the  printer icon on your taskbar (in the lower right corner of your screen). Select **Head Cleaning**.

Macintosh OS 8.6 to 9.x: Open the File menu and choose **Page Setup** or **Print**. Click the  Utility button, then click the  Head Cleaning button.

Macintosh OS X: Open the **Applications** folder and select **EPSON Printer Utility**. Select **SP 900** in the printer list, click **OK**, and select **Head Cleaning**.

3. Follow the instructions on the screen to clean the print head.

Cleaning takes about 45 seconds. The printer makes noise and the green  power light flashes.



Never turn off the printer while the green  power light is flashing, unless the printer hasn't moved or made noise for more than 5 minutes.

When the green  power light stops flashing, make sure paper is loaded in the printer, then do the following:

Windows: Click **Print nozzle check pattern**. Then click **Print**.

Macintosh: Click **Confirmation**, then click **Next**.

The nozzle check pattern prints (see "Examining the Nozzle Check Pattern" below for details).

4. If the nozzle check pattern has no gaps or white lines, click **Finish**.

If the pattern has white lines, click **Clean** to clean the print head again.

If you don't see any improvement after cleaning three or four times, see the *Printer Basics* manual for problem solving guidelines.

You can also turn the printer off and wait overnight—this allows any dried ink to soften—and then try cleaning the print head again.

Examining the Nozzle Check Pattern

Examine the nozzle check pattern you printed. Each staggered line should be solid, with no gaps, as shown.

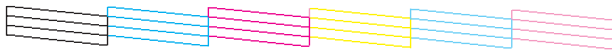

If your printout looks okay, you're done.

If you see any gaps (as shown below), clean the print head again.



Aligning the Print Head

If your printouts contain misaligned vertical lines, or you see light or dark horizontal banding, you may need to align the print head.

1. Turn on the printer.
2. Load several sheets of paper.
3. **Windows:** Right-click the printer icon on your taskbar (in the lower right corner of your screen). Select **Print Head Alignment**.

Macintosh OS 8.6 to 9.x: From the File menu, select **Page Setup** or **Print**. Click the Utility button, then click the Print Head Alignment button.

Macintosh OS X: Open the Applications folder and select **EPSON Printer Utility**. Select **SP 900** in the printer list, click **OK**, and select **Print Head Alignment**.

4. Follow the instructions on the screen to print a test page. You see this window:

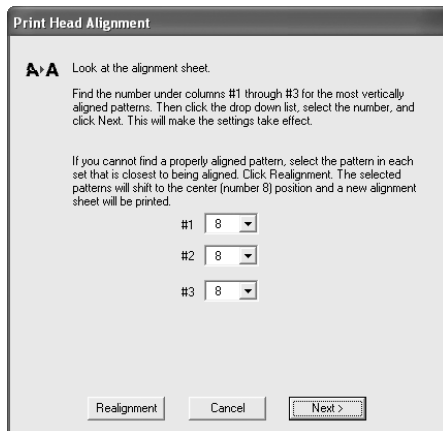

5. On the test page, select the pattern with the two vertical lines most precisely printed on top of each other. You may need to use a magnifying glass or loupe.

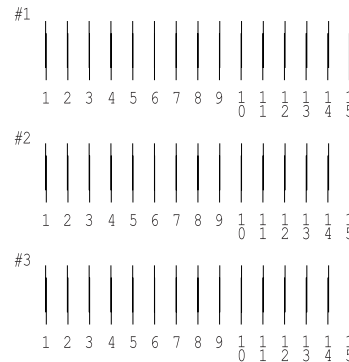

Select one pattern each for rows 1 through 3. Enter the number of the best pattern for each row in the corresponding boxes on the screen. Then click **Next**.

If you can't find an aligned pattern, choose the one that's closest to being aligned. Then click **Realignment** to print another test page and repeat this step.

After you click **Next**, you see this window:

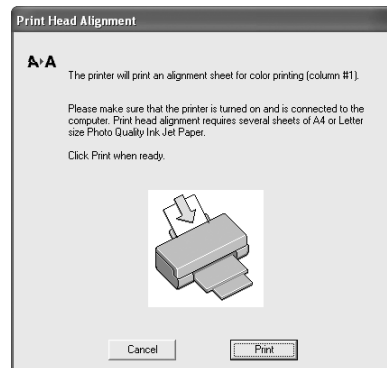

6. Click **Print** to print the first pattern on the next test page.

- After it prints, remove and reload the test page as shown, with pattern row #1 on the right.

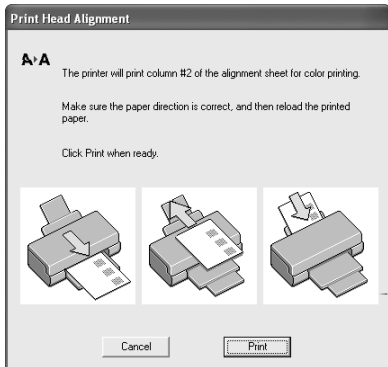

- Click **Print** again to print the second test pattern.
- On the test page, select a box for columns 1 and 2 that does not contain any light or dark banding.

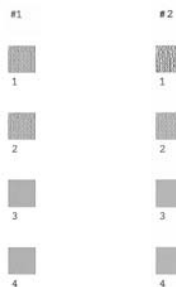

Enter the number of the best looking box in each column in the corresponding boxes on the screen and click **Finish**.

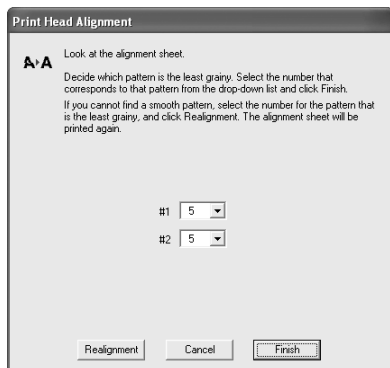

If you can't find a box that doesn't contain banding, choose the one that looks the best. Then click **Realignment** to print another test page and repeat steps 6 through 9.

Cleaning the Printer

To keep your printer working at its best, you should clean it several times a year.

- Turn off the printer, unplug the power cord, and disconnect the cable.
- Remove all the paper, then use a soft lint-free cloth to clean the sheet feeder.
- If the outer case or inside of the sheet feeder is dirty, clean it with a soft cloth dampened with mild detergent. Keep the printer cover closed to prevent water from getting inside.
- If ink accidentally gets inside the printer, wipe it off with a damp cloth.

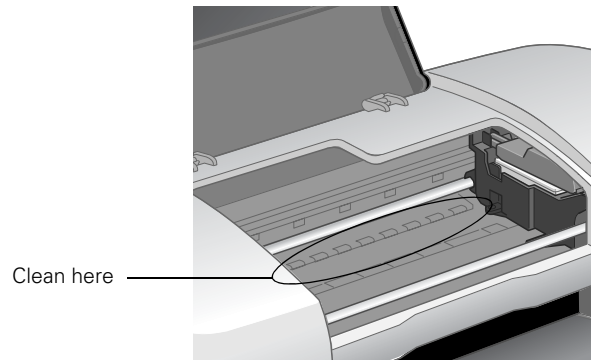

Don't touch the gears or any other parts inside the printer.



Never use a hard or abrasive brush, or benzene, alcohol, or paint thinner for cleaning; they can damage the printer components and case. Don't get water on the printer components and don't spray lubricants or oils inside the printer.

Transporting the Printer

If you need to ship your printer, you must prepare it for transportation in its original box or one of a similar size.



To avoid damage, always leave the ink cartridges installed when transporting the printer.

1. Open the printer cover and turn on the printer. Wait until the print head locks in the far right position, then turn off the printer.
2. Unplug the power cord from the electrical outlet. Then disconnect the printer cable from the printer.
3. Remove any paper from the printer, then remove the paper support and roll paper holders.
4. Open the printer cover. Secure the ink cartridge holder with the plastic insert that came with your printer (or secure it to the case with tape).

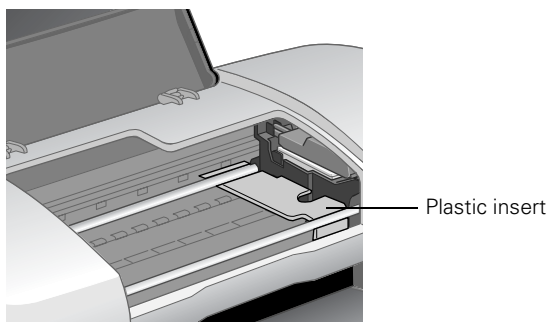

Be sure to remove the insert after installing the printer in its new location.

5. Close the printer cover, push in the output tray extension, then close the output tray.
6. Repack the printer and its attachments in the original box using the protective materials that came with them.

Keep the printer level as you transport it.

After transporting the printer, remove the plastic insert or tape securing the print head and test your printer. If you notice a decline in print quality, clean the print head as described on page 11; if output is misaligned, align the print head as described on page 12.

Related Documentation

CPD-15860R1 4042669-00	EPSON Stylus Photo 900 <i>Start Here</i>
CPD-15861R1 4042670-00	EPSON Stylus Photo 900 <i>Printer Basics</i>
CPD-15862R1 3020522-00	EPSON Stylus Photo 900 CD-ROM with <i>Reference Guide</i>
PL-SP900	EPSON Stylus Photo 900 Parts Price List