

Technical Information  
Operating Instructions

**GPS167SV**

Incl. Windows Software  
GPSMON32

## **Imprint**

Meinberg Funkuhren GmbH & Co. KG  
Auf der Landwehr 22  
D-31812 Bad Pyrmont

Phone: +49 (0) 52 81 / 9309-0  
Fax: +49 (0) 52 81 / 9309-30

Internet: <http://www.meinberg.de>  
Email: [info@meinberg.de](mailto:info@meinberg.de)

May 05, 2006

# Table of Contents

Imprint .....	2
General Information .....	6
GPS167SV Features .....	7
Time Zone and Daylight Saving Time .....	8
Pulse Outputs .....	8
Frequency Outputs (optional) .....	8
Time Capture Inputs .....	9
Asynchronous Serial Ports (optional 4x COM) .....	9
DCF77 Emulation .....	10
Programmable Pulses (optional) .....	11
Timecode outputs (optional) .....	11
Abstract .....	11
Installation .....	12
Power Supply .....	12
Mounting the Antenna .....	12
Assembly with CN-UB/E (optional) .....	13
Powering Up the System .....	14
The Front Panel Layout .....	15
FAIL LED .....	15
LOCK LED .....	15
BSL Button .....	15
OSC. RESET Button .....	16
GPS INIT Button .....	16
RS232 COM0 .....	16
Solder bridge RXD <=>TXD .....	16

Skilled/Service-Personnel only: Replacing the Lithium Battery .....	17
CE Label .....	17
Technical Specifications GPS167SV .....	18
Specifications of Internal Oscillator .....	20
Technical Specifications GPS167 Antenna .....	21
Time Strings .....	22
Format of the Meinberg Standard Time String .....	22
Format of the Meinberg Capture String .....	23
Format of the SAT Time String .....	24
Format of the Uni Erlangen String (NTP) .....	25
Format of the NMEA 0183 String (RMC) .....	27
Format of the ABB SPA Time String .....	28
Format of the Computime Time String .....	29
Timecode .....	31
Principle of Operation .....	31
Block Diagram Timecode .....	31
IRIG Standard Format .....	32
AFNOR Standard Format .....	33
Assignment of CF Segment in IEEE1344 mode .....	34
Generated Timecodes .....	35
Selection of Generated Time Code .....	36
Outputs .....	36
AM Sine Wave Output .....	36
PWM DC Outputs .....	36
Technical Data .....	37
Signal Description GPS167 V7.x .....	38
Rear Connector Pin Assignments GPS167 V7.x .....	39

The GPSMON32 Configuration and Monitoring Application .....	41
Serial Connection .....	41
Network Connection .....	41
Online Help .....	42
Diskette with Windows Software GPSMON32 .....	43

## General Information

The satellite receiver clock GPS167 has been designed to provide extremely precise time to its user. The clock has been developed for applications where conventional radio controlled clocks can't meet the growing requirements in precision. High precision available 24 hours a day around the whole world is the main feature of the new system which receives its information from the satellites of the Global Positioning System.

The Global Positioning System (GPS) is a satellite-based radio-positioning, navigation, and time-transfer system. It was installed by the United States Department of Defense and provides two levels of accuracy: The Standard Positioning Service (SPS) and the Precise Positioning Service (PPS). While PPS is encrypted and only available for authorized (military) users, SPS has been made available to the general public.

GPS is based on accurately measuring the propagation time of signals transmitted from satellites to the user's receiver. A nominal constellation of 21 satellites together with several active spares in six orbital planes 20000 km over ground provides a minimum of four satellites to be in view 24 hours a day at every point of the globe. Four satellites need to be received simultaneously if both receiver position (x, y, z) and receiver clock offset from GPS system time must be computed. All the satellites are monitored by control stations which determine the exact orbit parameters as well as the clock offset of the satellites' on-board atomic clocks. These parameters are uploaded to the satellites and become part of a navigation message which is retransmitted by the satellites in order to pass that information to the user's receiver.

The high precision orbit parameters of a satellite are called ephemeris parameters whereas a reduced precision subset of the ephemeris parameters is called a satellite's almanac. While ephemeris parameters must be evaluated to compute the receiver's position and clock offset, almanac parameters are used to check which satellites are in view from a given receiver position at a given time. Each satellite transmits its own set of ephemeris parameters and almanac parameters of all existing satellites.

## **GPS167SV Features**

The GPS167SV hardware is a 100mm x 160mm microprocessor board. The 40.6mm wide front panel integrates two LED indicators and 3 covered push buttons. The receiver is connected to the antenna/converter unit by a 50 ohm coaxial cable (refer to "Mounting the Antenna"). Feeding the antenna/converter occurs DC insulated via the antenna cable. Optional an antenna diplexer for up to four receivers connected to one antenna is available.

The GPS167SV is using the "Standard Positioning Service" SPS. Navigation messages coming in from the satellites are decoded by the GPS167SV microprocessor in order to track the GPS system time. Compensation of the RF signal's propagation delay is done by automatic determination of the receiver's geographical position. A correction value computed from the satellites' navigation messages increases the accuracy of the board's oven controlled master oscillator (OCXO) and automatically compensates the OCXO's aging. The last state of this value is restored from the battery buffered memory at power-up.

The GPS167SV has several different optional outputs, including three programmable pulses, modulated / unmodulated timecode and max. four RS232 COM ports, depending on the hardware configuration. Additionally, you can get the GPS167SV with different OCXO's (e.g. OCXO- LQ / MQ / HQ or Rubidium) to cover all levels of accuracy requirements.

**You can review and change the hard- and software configuration options of the clock with the GPSSMON32 application (see corresponding section in this manual).**

## **Time Zone and Daylight Saving Time**

GPS system time differs from the universal time scale (UTC) by the number of leap seconds which have been inserted into the UTC time scale after GPS has been initiated in 1980. The current number of leap seconds is part of the navigation message supplied by the satellites, so GPS167SV's internal real time is based on UTC. Conversion to local time including handling of daylight saving time for each year can be performed by the receiver's microprocessor if the corresponding parameters are correctly set by using the GPSMON32 application.

## **Pulse Outputs**

The pulse generator of GPS167SV generates pulses once per second (P\_SEC) and once per minute (P\_MIN). Additionally, master frequencies of 10 MHz, 1 MHz and 100 kHz are derived from the oscillator. All the pulses are available with TTL level at the rear connector.

## **Frequency Outputs (optional)**

The optional synthesizer generates a frequency from 1/8 Hz up to 10 MHz synchronous to the internal timing frame. The phase of this output can be shifted from  $-360^\circ$  to  $+360^\circ$  for frequencies less than 10 kHz. Both frequency and phase can be configured with the GPSMON32 application via serial port COM0. Synthesizer output is available at the rear connector as sine-wave output (F\_SYNTH\_SIN), with TTL level (F\_SYNTH) and via an open drain output (F\_SYNTH\_OD). The open drain output can be used to drive an optocoupler when a low frequency is generated.

In the default mode of operation, pulse outputs and the synthesizer output are disabled until the receiver has synchronized after power-up. However, the system can be configured to enable those outputs immediately after power-up. An additional TTL output (TIME\_SYN) reflects the state of synchronization. This output switches to TTL HIGH level when synchronization has been achieved and returns to TTL LOW level if no satellite can be received or the receiver is manually forced to another mode of operation by the user.



## **Time Capture Inputs**

Two time capture inputs called User Capture 0 and 1 are provided at the rear connector (CAP0 and CAP1) to measure asynchronous time events. A falling TTL slope at one of these inputs lets the microprocessor save the current real time in its capture buffer. Capture events are then printed out via COM0 or COM1. The capture buffer has a capacity of more than 500 events, so either a burst of events with intervals down to less than 1.5 msec or a continuous stream of events at a lower rate depending on the transmission speed of COM0 or COM1 can be recorded. The format of the output string is ASCII, see the technical specifications at the end of this document for details. If the capture buffer is full a message "\*\*\* capture buffer full" is transmitted, if the interval between two capture events is too short the warning "\*\*\* capture overrun" is being sent.

## **Asynchronous Serial Ports (optional 4x COM)**

Up to four asynchronous serial RS232 interfaces (COM0 ... COM3) are available to the user. In the default mode of operation, the serial outputs are disabled until the receiver has synchronized after power-up. However, the system can be configured to enable those outputs immediately after power-up. Transmission speeds, framings and mode of operation can be configured separately using GPSMON32. COM0 is compatible with other radio remote clocks made by Meinberg. It sends the time string either once per second, once per minute or on request (after receiving a '?' character). Additionally the interfaces can be configured to transmit capture data either automatically when available or on request. The format of the output strings is ASCII, see the technical specifications at the end of this document for details. The corresponding parameters can be set up by GPSMON32 via the serial port COM0.

## DCF77 Emulation

The GPS167 satellite controlled clock generates TTL level time marks (active HIGH) which are compatible with the time marks distributed by the German long wave radio transmitter DCF77. This time broadcast station installed in Mainflingen near Frankfurt/Germany transmits the reference time of the Federal Republic of Germany: time of day, date of month and day of week in BCD coded second pulses. The complete time information is transmitted once every minute. Please note that the GPS167SV generates time marks representing its local time as configured by the user, including announcement of changes in daylight saving and announcement of leap seconds. The coding scheme is given below:

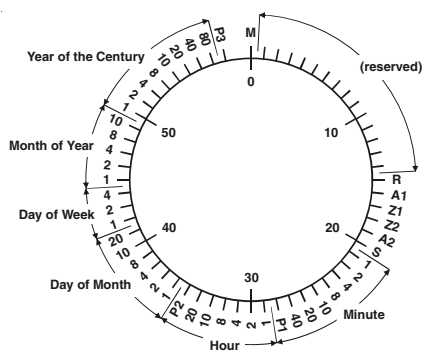

M	Start of Minute (0.1 s)
R	RF Transmission via secondary antenna
A1	Announcement of a change in daylight saving
Z1, Z2	Time zone identification
	Z1, Z2 = 0, 1: Daylight saving disabled
	Z1, Z2 = 1, 0: Daylight saving enabled
A2	Announcement of a leap second
S	Start of time code information
P1, P2, P3	Even parity bits

Time marks start at the beginning of a new second. If a binary "0" is to be transmitted, the length of the corresponding time mark is 100 msec, if a binary "1" is transmitted, the time mark has a length of 200 msec. The information on the current date and time as well as some parity and status bits can be decoded from the time marks of the 15th up to the 58th second every minute. The absence of any time mark at the 59th second of a minute signals that a new minute will begin with the next time mark. The DCF emulation output is enabled immediately after power-up.

## **Programmable Pulses** (optional)

At the male connector Typ VG64 there are three programmable TTL outputs (Prog Pulse 0-2), which are arbitrarily programmable using the GPSSMON32 software.

Other technical details are described at the end of this manual.

## **Timecode outputs** (optional)

### **Abstract**

The transmission of coded timing signals began to take on widespread importance in the early 1950's. Especially the US missile and space programs were the forces behind the development of these time codes, which were used for the correlation of data. The definition of time code formats was completely arbitrary and left to the individual ideas of each design engineer. Hundreds of different time codes were formed, some of which were standardized by the "Inter Range Instrumentation Group" (IRIG) in the early 60's.

Except these "IRIG Time Codes", other formats like NASA36, XR3 or 2137 are still in use. The board GPS167 can generate the IRIG-B, AFNOR NFS 87-500 code as well as IEEE1344 code which is an IRIG-B123 code extended with information for time zone, leap second and date. Other formats may be available on request.

At the male connector Typ VG64 there are IRIG-B modulated (3Vpp into 50 Ohm) and IRIG-B unmodulated DC level shift.

## Installation

### Power Supply

The power supply used with a GPS167 has to provide only one output of +5V. The output voltage should be well regulated because drifting supply voltages reduce the short time accuracy of the generated frequencies and timing pulses. The power supply lines should have low resistance and must be connected using both pins a and c of the rear connector.

### Mounting the Antenna

The GPS satellites are not geostationary, each of them circles around the earth approx. every 12 hours. The satellite signals can be received only if no building or any other object is in the line-of-sight from the antenna to the satellite, therefore the antenna/converter unit must be installed in a location with an unobstructed view of the sky. Very good reception is possible when the antenna has a free view of 8° angular elevation above horizon. If this is not possible the antenna should be installed with a free view to the equator because of the satellite courses which are located between latitudes of 55° North and 55° South. If even this is not possible, problems will occur, especially during position aquisition, when at least four satellites for calculation of the receivers position have to be available. As soon as the position has been determined, one satellite is enough to remain in synchronized state.

The antenna/converter unit can be mounted on a pole with a diameter up to 60 mm or at a wall. Every GPS167 comes with a 50cm plastic tube, two holders for wall-mounting and clamps for pole-mounting. A standard coaxial cable with 50 ohms impedance should be used to connect the antenna/converter unit to the receiver. The maximum lenght of cable between antenna and receiver depends on the attenuation factor of the used coaxial cable.

Example:

Type of cable	diameter Ø [mm]	Attenuation at 100MHz [dB]/100m	max. lenght [m]
RG58/CU	5mm	15.9	300 <sup>1</sup>
RG213	10.5mm	6.9	700 <sup>1</sup>
1)This specifications are made for antenna/converter units produced after January, 2005			
The values are typically ones; the exact ones are to find out from the data sheet of the used cable.			

Up to four GPS167 receivers can be run with one antenna/converter unit by using the optional antenna diplexer. The total length of one antenna line between antenna, diplexer and receiver must not be longer than the max. length shown in the table above. The position of the diplexer in the antenna line does not matter.

When installing the high voltage protector CN-UB/E (CN-UB-280DC) be aware to set it directly after reaching indoor. The CN-UB/E is not for outdoor usage.

### Assembly with CN-UB/E (optional)

Optionally the overvoltage protector CN-UB/E is available. Normally you directly connect the antenna converter to the system with the antenna cable.

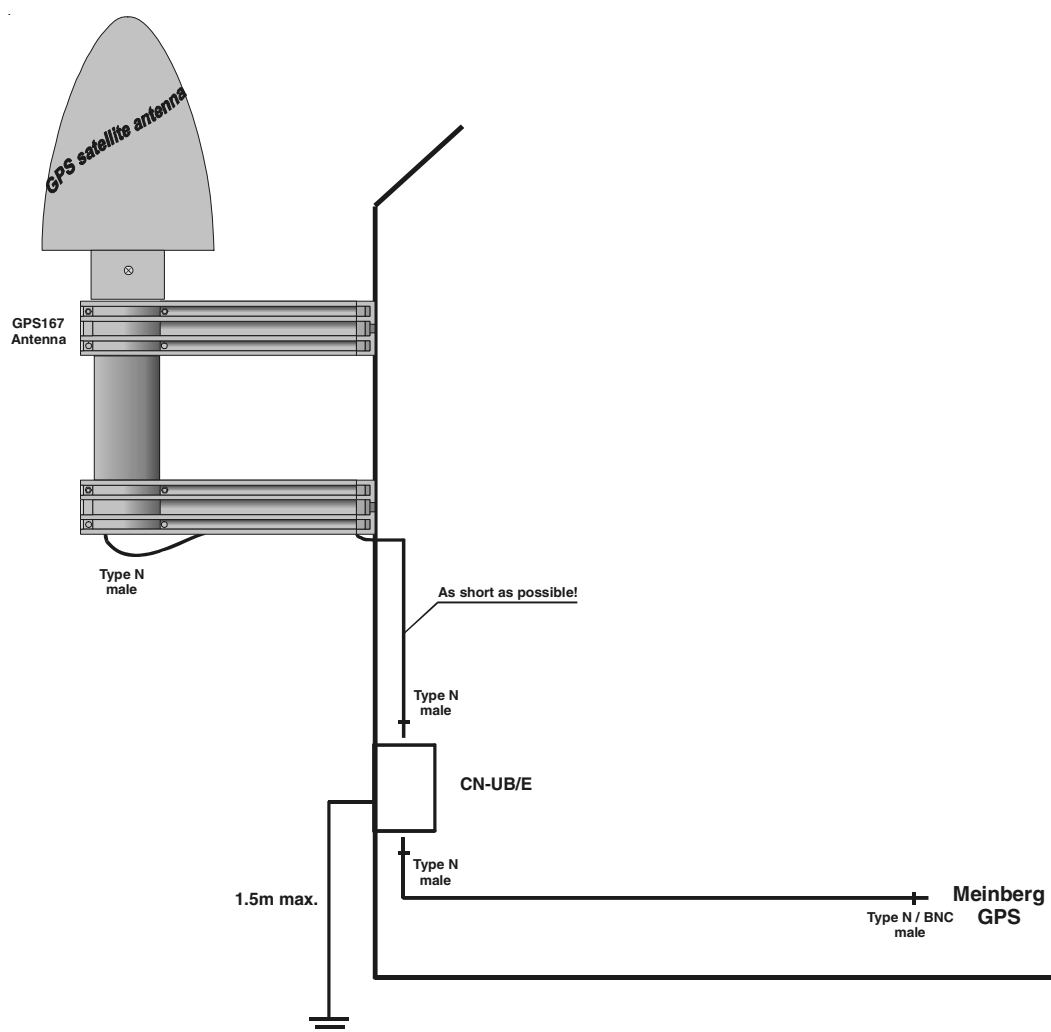

## Powering Up the System

If both the antenna and the power supply have been connected, the system is ready to operate. Between 10 seconds (with OCXO-LQ) and 3 minutes (with OCXO-MQ / HQ option) after power-up the receiver's oscillator has warmed up and operates with the specified accuracy. If the receiver finds valid almanac and ephemeris data in its battery buffered memory and the receiver's position has not changed significantly since its last operation, the receiver can find out which satellites are in view now. Only a single satellite needs to be received to synchronize and generate output pulses, therefore synchronization state can be reached within one minute (OCXO-LQ) or within 10 minutes (OCXO-MQ / HQ) after start. After 20 minutes of operation the OCXO is fully adjusted and the generated frequencies are within the specified limits.

If the receiver position has changed by some hundred kilometers since last operation, the satellites' real elevation and doppler might not match the values expected by the receiver thus forcing it to start scanning for satellites. This mode is called **Warm Boot**, and the receiver can obtain ID numbers of existing satellites from the valid almanac. When the receiver has found four satellites in view it can recalculate its position and afterwards will switch to **Normal Operation**. If the almanac has been lost due to a disconnected battery, the receiver will scan for a satellite and read in the current almanacs (every satellite periodically transmits them). This mode is called **Cold Boot**. It takes up to 12 minutes until the new almanac has been received completely and upon completion the system will switch to **Warm Boot** mode, scanning for other available satellites.

In the standard mode of operation, neither pulse and synthesizer outputs nor the serial ports will be enabled after power-up until full GPS synchronization has been achieved. However, it is possible to configure some or all of those outputs to be enabled immediately after power-up. If the system starts up in a new environment (e. g. receiver position has changed or new power supply) it can take a couple of minutes until the OCXO's output frequency has been adjusted. Until this point the frequency accuracy drops to  $10^{-8}$  reducing the accuracy of pulses to  $\pm 5\mu\text{s}$ .

## The Front Panel Layout

### FAIL LED

The FAIL LED is turned on whenever the TIME\_SYN output is low (receiver is not synchronized).

### LOCK LED

The LOCK LED is turned on when after power-up the receiver has acquired at least four satellites and has computed its position. In normal operation the receiver position is updated continuously as long as at least four satellites can be received. When the receivers position is known and steady only a single satellite needs to be received to synchronize and generate output pulses.

### BSL Button

Whenever the on-board software must be upgraded or modified, the new firmware can be downloaded to the internal flash memory via the serial port COM0. There is no need to open the metal case and insert a new EPROM.

If the BSL pushbutton behind the front panel is pressed while the system is powered up, a bootstrap-loader is activated and waits for instructions from the serial port COM0. The new firmware can be sent to GPS167SV from any standard PC with serial interface. A loader program will be shipped together with the file containing the image of the new firmware.

The contents of the program memory will not be modified until the loader program has sent the command to erase the flash memory. So if the BSL pushbutton is pressed unintentionally while the system is powered up, the firmware will not be changed accidentally. After the next power-up, the system will be ready to operate again.

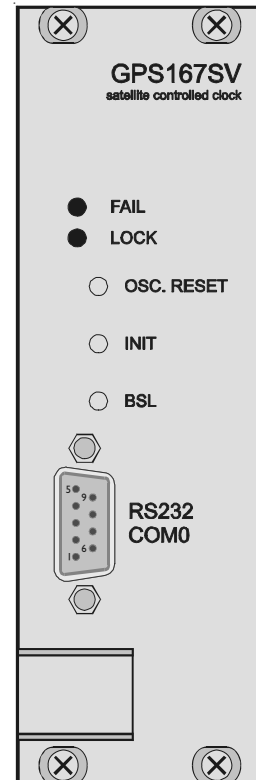

## OSC. RESET Button

If the TCXO/OCXO RESET pushbutton in the frontpanel is pressed, the values used to discipline the TCXO resp. OCXO are saved to an internal EEPROM. The DAC value used for fine-tuning the oscillator will be reset in this case.

## GPS INIT Button

The GPS INIT pushbutton in the front panel lets the user initialize all GPS datas, i.e. all saved satellite datas will be cleared. The system starts operating in the COLD BOOT mode and seeks for a satellite to read its actual parameters.

If the key is pressed while the system is powered up the battery buffered memory is cleared additional and user definable parameters are reset to factory defaults.

## RS232 COM0

The serial port COM0 is accessible via a 9pin DSUB male connector (older version 9pol. DSUB male connector) in the frontpanel of the GPS167SV, parallel hardwired to the COM0 port on the rear VG edge connector.

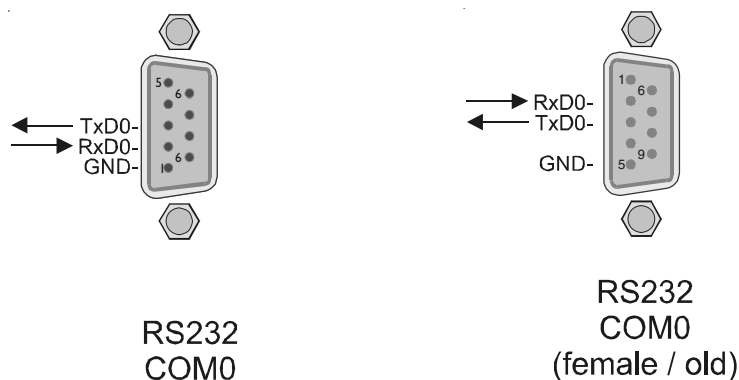

## Solder bridge RXD <=>TXD

The pin assignment of the 9pol. DSUB male connector (TXD and RXD) can be turned by internal solder bridge (see figure below).

The standard setting is Pin2 = RXD and Pin3 = TXD (solder bridge ri. top / le. botton)





### **Skilled/Service-Personnel only: Replacing the Lithium Battery**

The lifespan of the lithium battery on the board is at least 10 years. If it is required to replace the battery, the following should be noted:

#### **ATTENTION!**

**Danger of explosion in case of inadequate replacement of the lithium battery. Only identical batteries or batteries recommended by the manufacturer must be used for replacement. The waste battery must be disposed as proposed by the manufacturer of the battery.**

### **CE Label**



This device conforms to the directive 89/336/EWG on the approximation of the laws of the Member States of the European Community relating to electromagnetic compatibility.

## Technical Specifications GPS167SV

RECEIVER:	6 channel C/A code receiver with external antenna/converter unit
ANTENNA:	Antenna/converter unit with remote power supply refer to chapter "Technical Specifications GPS167 Antenna"
ANTENNA INPUT:	antenna circuit dc-insulated; dielectric strength: 1000V <sub>DC</sub> Length of cable: refer to chapter "Mounting the Antenna"
TIME TO SYNCHRONIZATION:	one minute with known receiver position and valid almanac 12 minutes if invalid battery buffered memory
PULSE OUTPUTS:	change of second (P_SEC, TTL level) change of minute (P_MIN, TTL level)
ACCURACY OF PULSES:	after synchronization and 20 minutes of operation: TCXO HQ/OCXO LQ : better than $\pm 250$ nsec OCXO MQ/OCXO HQ : better than $\pm 100$ nsec  better than $\pm 2$ $\mu$ sec during the first 20 minutes of operation
FREQUENCY OUTPUTS:	10 MHz, 1 MHz, 100 kHz (TTL level)
ACCURACY OF FREQUENCY:	see Oscillator specification
FREQUENCY SYNTHESIZER:	1/8 Hz up to 10 MHz
ACCURACY OF SYNTHESIZER:	base accuracy depends on system accuracy  1/8 Hz to 10 kHz Phase synchron with pulse output P_SEC 10 kHz to 10 MHz frequency deviation $< 0.0047$ Hz

## SYNTHESIZER

OUTPUTS:

F_SYNTH:	TTL level		
F_SYNTH_OD:	open drain		
	drain voltage:	< 100 V	
	sink current to GND:	< 100 mA	
	dissipation power at 25°C:	< 360 mW	
F_SYNTH_SIN	sine-wave		
	output voltage:	1.5 V eff.	
	output impedance:	200 Ohm	

## TIME\_SYN

OUTPUT: TTL HIGH level if synchronized

SERIAL PORTS: max. 4 asynchronous serial ports (RS-232)

Baud Rate: 300 up to 19200  
Framing: 7N2, 7E1, 7E2, 8N1, 8N2, 8E1

default setting:

COM0:	19200, 8N1
COM1:	9600, 8N1
COM2:	9600, 8N1
COM3:	9600, 8N1

Annotation: Even if one of the setup functions "INIT USER PARS" or "Resetting Factory Defaults" is executed, the serial port parameters are reset to default values only if invalid parameters have been configured.

## TIME CAPTURE

INPUTS: triggered on falling TTL slope  
Interval of events: 1.5msec min.  
Resolution: 100ns

## POWER

REQUIREMENTS: 5 V  $\pm$  5%, max @1100mA (siehe Oszillatorspezifikationen)

## PHYSICAL

DIMENSIONS: Eurocard, 100mm x 160mm, 1.5mm Epoxy

FRONT PANEL: 3U / 8HP (128mm high x 40.5mm wide), Aluminium

REAR EDGE

CONNECTOR: according to DIN 41612, type C 64, rows a+c (male)

RF CONNECTOR: coaxial SMB connector (male)

AMBIENT

TEMPERATURE: 0 ... 50°C

HUMIDITY: 85% max.

## Specifications of Internal Oscillator

	TCXO	OCXO LQ	OCXO MQ	OCXO HQ
Kurzzeitstabilität $\tau = 1 \text{ sec}$	$2 * 10^{-9}$	$1 * 10^{-9}$	$2 * 10^{-10}$	$1 * 10^{-11}$
Freilaufgenauigkeit ein Tag	$\pm 1 * 10^{-7}$ ± 1 Hz (Note 1)	$\pm 2 * 10^{-8}$ ± 0.2 Hz (Note 1)	$\pm 1,5 * 10^{-9}$ ± 15 mHz (Note 1)	$\pm 5 * 10^{-10}$ ± 5 mHz (Note 1)
Freilaufgenauigkeit ein Jahr	$\pm 1 * 10^{-6}$ ± 10 Hz (Note 1)	$\pm 4 * 10^{-7}$ ± 4 Hz (Note 1)	$\pm 1 * 10^{-7}$ ± 1 Hz (Note 1)	$\pm 5 * 10^{-8}$ ± 0.5 Hz (Note 1)
Genauigkeit GPS-synchron 24 Std. gemittelt	$\pm 1 * 10^{-11}$	$\pm 1 * 10^{-11}$	$\pm 5 * 10^{-12}$	$\pm 1 * 10^{-12}$
Phasenrauschen	1 Hz -60 dBc/Hz 10 Hz -90 dBc/Hz 100 Hz -120 dBc/Hz 1 kHz -130 dBc/Hz	1 Hz -60 dBc/Hz 10 Hz -90 dBc/Hz 100 Hz -120 dBc/Hz 1 kHz -130 dBc/Hz	1 Hz -75 dBc/Hz 10 Hz -110 dBc/Hz 100 Hz -130 dBc/Hz 1 kHz -140 dBc/Hz	1 Hz -95 dBc/Hz 10 Hz -125 dBc/Hz 100 Hz -145 dBc/Hz 1 kHz -155 dBc/Hz
Stromversorgung bei 25°C Normalbetrieb Aufheizphase	+5V / 20 mA N/A	+5V / 160 mA +5V / 380 mA	+5V / 90 mA +5V / 330 mA	+5V / 160 mA +5V / 600 mA
Temperaturdrift im Freilauf	$\pm 1 * 10^{-6}$ (-20...70°C)	$\pm 2 * 10^{-7}$ (0...60°C)	$\pm 5 * 10^{-8}$ (-20...70°C)	$\pm 1 * 10^{-8}$ (5...70°C)

### Note 1:

Die berechnete Genauigkeit in Hertz basiert auf der Normalfrequenz von 10 MHz. Zum Beispiel:

Genauigkeit des TCXO HQ (Freilauf ein Tag) ist  $\pm 1 * 10^{-7} * 10 \text{ MHz} = \pm 1 \text{ Hz}$

## Technical Specifications GPS167 Antenna

ANTENNA: dielectrical patch antenna, 25 x 25mm  
receive frequency: 1575.42 MHz  
bandwidth: 9 MHz

CONVERTER: local oscillator to converter frequency: 10 MHz  
first IF frequency: 35.4 MHz

### POWER

REQUIREMENTS: 12V ... 18V, @ 100mA (provided via antenna cable)

CONNECTOR: coax type N, female

### AMBIENT

TEMPERATURE: -40 ... +65°C

HOUSING: ABS plastic case for outdoor installation (IP56)

### PHYSICAL DIMENSION:

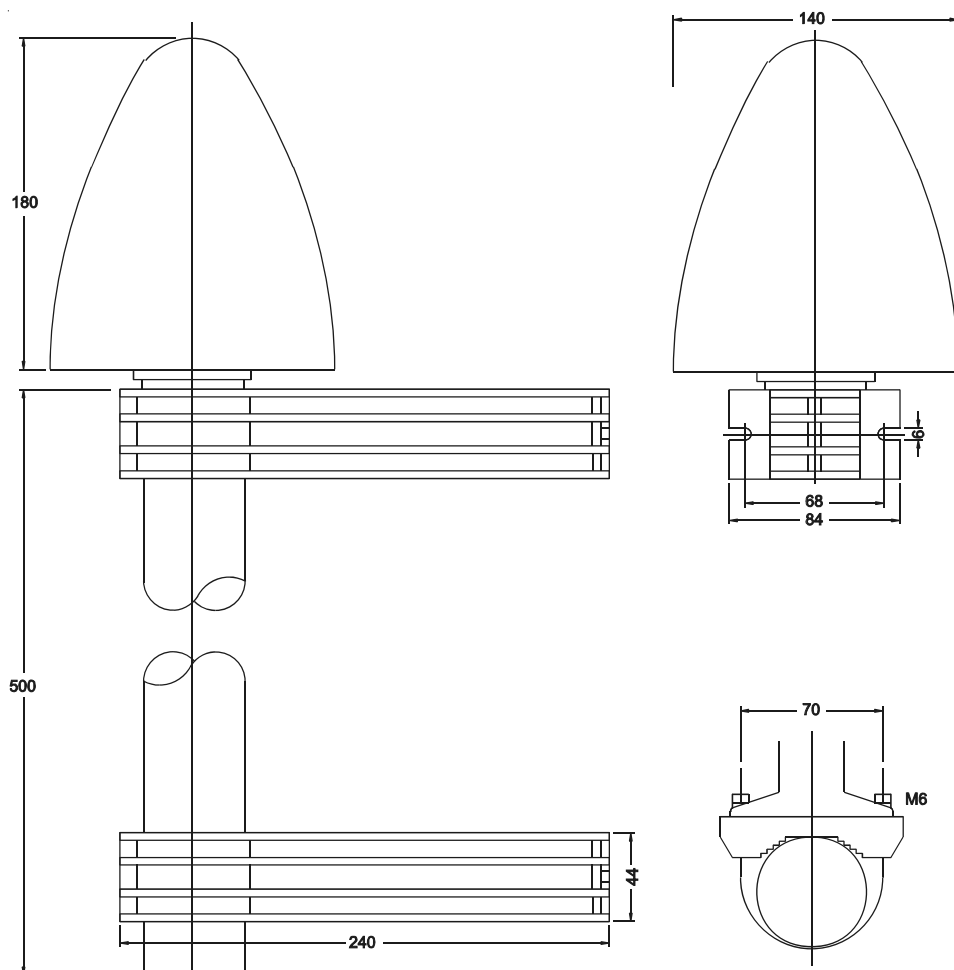

## Time Strings

### Format of the Meinberg Standard Time String

The Meinberg Standard Time String is a sequence of 32 ASCII characters starting with the STX (start-of-text) character and ending with the ETX (end-of-text) character. The format is:

**<STX>D:dd.mm.yy;T:w;U:hh.mm.ss;uvxy<ETX>**

The letters printed in *italics* are replaced by ASCII numbers whereas the other characters are part of the time string. The groups of characters as defined below:

<b>&lt;STX&gt;</b>	Start-Of-Text, ASCII Code 02h sending with one bit accuracy at change of second
<i>dd.mm.yy</i>	the current date: <i>dd</i> day of month (01..31) <i>mm</i> month (01..12) <i>yy</i> year of the century (00..99)
<i>w</i>	the day of the week (1..7, 1 = Monday)
<i>hh.mm.ss</i>	the current time: <i>hh</i> hours (00..23) <i>mm</i> minutes (00..59) <i>ss</i> seconds (00..59, or 60 while leap second)
<i>uv</i>	clock status characters (depending on clock type): <i>u</i> : ‘#’ GPS: clock is running free (without exact synchr.) PZF: time frame not synchronized DCF77: clock has not synchronized after reset ‘ ‘ (space, 20h) GPS: clock is synchronous (base accuracy is reached) PZF: time frame is synchronized DCF77: clock has synchronized after reset <i>v</i> : ‘*’ GPS: receiver has not checked its position PZF/DCF77: clock currently runs on XTAL ‘ ‘ (space, 20h) GPS: receiver has determined its position PZF/DCF77: clock is synchronized with transmitter
<i>x</i>	time zone indicator: ‘U’ UTC Universal Time Coordinated, formerly GMT ‘ ‘ MEZ European Standard Time, daylight saving disabled ‘S’ MESZ European Summertime, daylight saving enabled
<i>y</i>	announcement of discontinuity of time, enabled during last hour before discontinuity comes in effect: ‘!’ announcement of start or end of daylight saving time ‘A’ announcement of leap second insertion ‘ ‘ (space, 20h) nothing announced
<b>&lt;ETX&gt;</b>	End-Of-Text, ASCII Code 03h

## Format of the Meinberg Capture String

The Meinberg Capture String is a sequence of 31 ASCII characters terminated by a CR/LF (Carriage Return/Line Feed) combination. The format is:

**CH***x\_tt.mm.jj\_hh:mm:ss.fffffff*<CR><LF>

The letters printed in *italics* are replaced by ASCII numbers whereas the other characters are part of the time string. The groups of characters as defined below:

*x*            0 or 1 corresponding on the number of the capture input  
–            ASCII space 20h

*dd.mm.yy* the capture date:

*dd*    day of month            (01..31)

*mm*    month                    (01..12)

*yy*    year of the century    (00..99)

*hh:mm:ss.fffffff* the capture time:

*hh*    hours                    (00..23)

*mm*    minutes                  (00..59)

*ss*    seconds                  (00..59, or 60 while leap second)

*fffffff*    fractions of second, 7 digits

<CR>       Carriage Return, ASCII Code 0Dh

<LF>       Line Feed, ASCII Code 0Ah

## Format of the SAT Time String

The SAT Time String is a sequence of 29 ASCII characters starting with the STX (start-of-text) character and ending with the ETX (end-of-text) character. The format is:

<STX>*dd.mm.yy/w/hh:mm:ssxxxuv*<ETX>

The letters printed in *italics* are replaced by ASCII numbers whereas the other characters are part of the time string. The groups of characters as defined below:

<STX> Start-Of-Text, ASCII Code 02h  
sending with one bit accuracy at change of second

*dd.mm.yy* the current date:

*dd* day of month (01..31)

*mm* month (01..12)

*yy* year of the century (00..99)

*w* the day of the week (1..7, 1 = Monday)

*hh:mm:ss* the current time:

*hh* hours (00..23)

*mm* minutes (00..59)

*ss* seconds (00..59, or 60 while leap second)

*xxxx* time zone indicator:

‘UTC’ Universal Time Coordinated, formerly GMT

‘MEZ’ European Standard Time, daylight saving disabled

‘MESZ’ European Summertime, daylight saving enabled

*u* clock status characters:

‘#’ clock has not synchronized after reset

‘ ‘ (space, 20h) clock has synchronized after reset

*v* announcement of discontinuity of time, enabled during last hour before discontinuity comes in effect:

‘!’ announcement of start or end of daylight saving time

‘ ‘ (space, 20h) nothing announced

<CR> Carriage Return, ASCII Code 0Dh

<LF> Line Feed, ASCII Code 0Ah

<ETX> End-Of-Text, ASCII Code 03h



## Format of the Uni Erlangen String (NTP)

The time string Uni Erlangen (NTP) of a **GPS clock** is a sequence of 66 ASCII characters starting with the STX (start-of-text) character and ending with the ETX (end-of-text) character. The format is:

`<STX>tt.mm.jj; w; hh:mm:ss; voo:oo; acdfg i;bbb.bbbbn ll.lllle hhhhm<ETX>`

The letters printed in *italics* are replaced by ASCII numbers whereas the other characters are part of the time string. The groups of characters as defined below:

<code>&lt;STX&gt;</code>	Start-Of-Text, ASCII Code 02h sending with one bit accuracy at change of second
<code>dd.mm.yy</code>	the current date: <code>dd</code> day of month (01..31) <code>mm</code> month (01..12) <code>yy</code> year of the century (00..99)
<code>w</code>	the day of the week (1..7, 1 = Monday)
<code>hh.mm.ss</code>	the current time: <code>hh</code> hours (00..23) <code>mm</code> minutes (00..59) <code>ss</code> seconds (00..59, or 60 while leap second)
<code>v</code>	sign of the offset of local timezone related to UTC
<code>oo:oo</code>	offset of local timezone related to UTC in hours and minutes
<code>ac</code>	clock status characters: <code>a:</code> ‘#’ clock has not synchronized after reset ‘ ‘ (space, 20h) clock has synchronized after reset  <code>c:</code> ‘*’ GPS receiver has not checked its position ‘ ‘ (space, 20h) GPS receiver has determined its position
<code>d</code>	time zone indicator: ‘S’ MESZ European Summertime, daylight saving enabled ‘ ‘ MEZ European Standard Time, daylight saving disabled
<code>f</code>	announcement of discontinuity of time, enabled during last hour before discontinuity comes in effect: ‘!’ announcement of start or end of daylight saving time ‘ ‘ (space, 20h) nothing announced
<code>g</code>	announcement of discontinuity of time, enabled during last hour before discontinuity comes in effect: ‘A’ announcement of leap second insertion ‘ ‘ (space, 20h) nothing announced

*i* leap second insertion  
     ‘L’ leap second is actually inserted  
         (active only in 60th sec.)  
     ‘ ’ (space, 20h) no leap second is inserted

*bbb.bbbb* latitude of receiver position in degrees  
             leading signs are replaced by a space character (20h)

*n* latitude, the following characters are possible:  
     ‘N’ north of equator  
     ‘S’ south d. equator

*lll.lll* longitude of receiver position in degrees  
             leading signs are replaced by a space character (20h)

*e* longitude, the following characters are possible:  
     ‘E’ east of Greenwich  
     ‘W’ west of Greenwich

*hhhh* altitude above sea level in meters  
             leading signs are replaced by a space character (20h)

<ETX> End-Of-Text, ASCII Code 03h

## Format of the NMEA 0183 String (RMC)

The NMEA String is a sequence of 65 ASCII characters starting with the '\$' character and ending with the characters CR (carriage return) and LF (line-feed). The format is:

**\$GPRMC,*hhmmss.ss,A,bbbb.bb,n,llll.ll,e,0.0,0.0,ddmmyy,0.0,a\*hh*<CR><LF>**

The letters printed in *italics* are replaced by ASCII numbers or letters whereas the other characters are part of the time string. The groups of characters as defined below:

\$	Start character, ASCII Code 24h sending with one bit accuracy at change of second
<i>hhmmss.ss</i>	the current time: <i>hh</i> hours (00..23) <i>mm</i> minutes (00..59) <i>ss</i> seconds (00..59, or 60 while leap second) <i>ss</i> fractions of seconds (1/10 ; 1/100)
A	Status (A = time data valid) (V = time data not valid)
<i>bbbb.bb</i>	latitude of receiver position in degrees leading signs are replaced by a space character (20h)
<i>n</i>	latitude, the following characters are possible: 'N' north of equator 'S' south d. equator
<i>llll.ll</i>	longitude of receiver position in degrees leading signs are replaced by a space character (20h)
<i>e</i>	longitude, the following characters are possible: 'E' east of Greenwich 'W' west of Greenwich
<i>ddmmyy</i>	the current date: <i>dd</i> day of month (01..31) <i>mm</i> month (01..12) <i>yy</i> year of the century (00..99)
<i>a</i>	magnetic variation
<i>hh</i>	checksum (EXOR over all characters except '\$' and '*')
<CR>	Carriage Return, ASCII Code 0Dh
<LF>	Line Feed, ASCII Code 0Ah

## Format of the ABB SPA Time String

The ABB SPA Time String is a sequence of 32 ASCII characters starting with the characters ">900WD" and ending with the <CR> (Carriage Return) character. The format is:

**>900WD;*yy-mm-tt\_hh.mm;ss.fff:cc*<CR>**

The letters printed in *italics* are replaced by ASCII numbers whereas the other characters are part of the time string. The groups of characters as defined below:

<i>yy-mm-tt</i>	the current date:	
<i>yy</i>	year of the century	(00..99)
<i>mm</i>	month	(01..12)
<i>dd</i>	day of month	(01..31)
–	Space (ASCII code 20h)	
<i>hh.mm;ss.fff</i>	the current time:	
<i>hh</i>	hours	(00..23)
<i>mm</i>	minutes	(00..59)
<i>ss</i>	seconds	(00..59, or 60 while leap second)
<i>fff</i>	milliseconds	(000..999)
<i>cc</i>	Check sum. EXCLUSIVE-OR result of the previous characters, displayed as a HEX byte (2 ASCII characters 0..9 or A..F)	
<CR>	Carriage Return, ASCII Code 0Dh	

## Format of the Computime Time String

The Computime time string is a sequence of 24 ASCII characters starting with the T character and ending with the LF (line feed, ASCII Code 0Ah) character. The format is:

**T:*yy:mm:dd:ww:hh:mm:ss*<CR><LF>**

The letters printed in *italics* are replaced by ASCII numbers whereas the other characters are part of the time string. The groups of characters as defined below:

T	Start character sending with one bit accuracy at change of second
<i>yy:mm:dd</i>	the current date:
<i>yy</i>	year of the century (00..99)
<i>mm</i>	month (01..12)
<i>dd</i>	day of month (01..31)
<i>ww</i>	the day of the week (01..07, 01 = monday)
<i>hh:mm:ss</i>	the current time:
<i>hh</i>	hours (00..23)
<i>mm</i>	minutes (00..59)
<i>ss</i>	seconds (00..59, or 60 while leap second)
<CR>	Carriage Return, ASCII Code 0Dh
<LF>	Line Feed, ASCII Code 0Ah



## Timecode

### Principle of Operation

The GPS167 board is capable of generating IRIG, AFNOR and IEEE1344 standard time codes. Apart from the digitally generated amplitude-modulated code, it also provides the unmodulated DC-Level shift code. The modulated sine wave carrier and the board's internal time pattern are derived from the radio clock's disciplined oscillator.

### Block Diagram Timecode

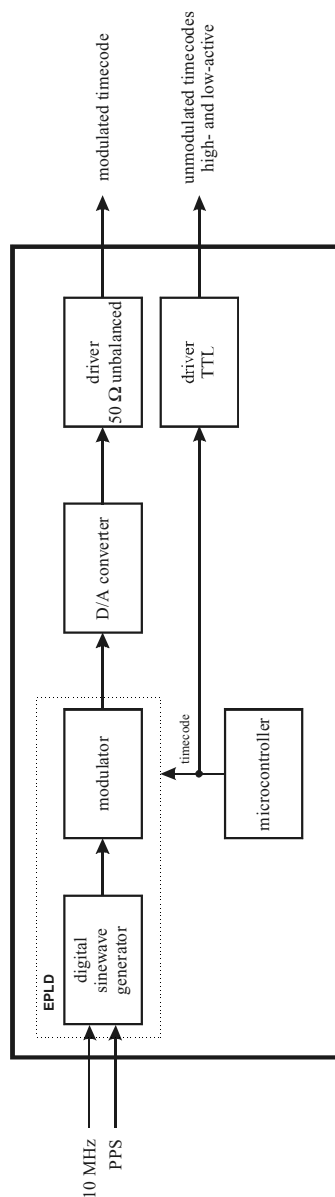

# IRIG Standard Format

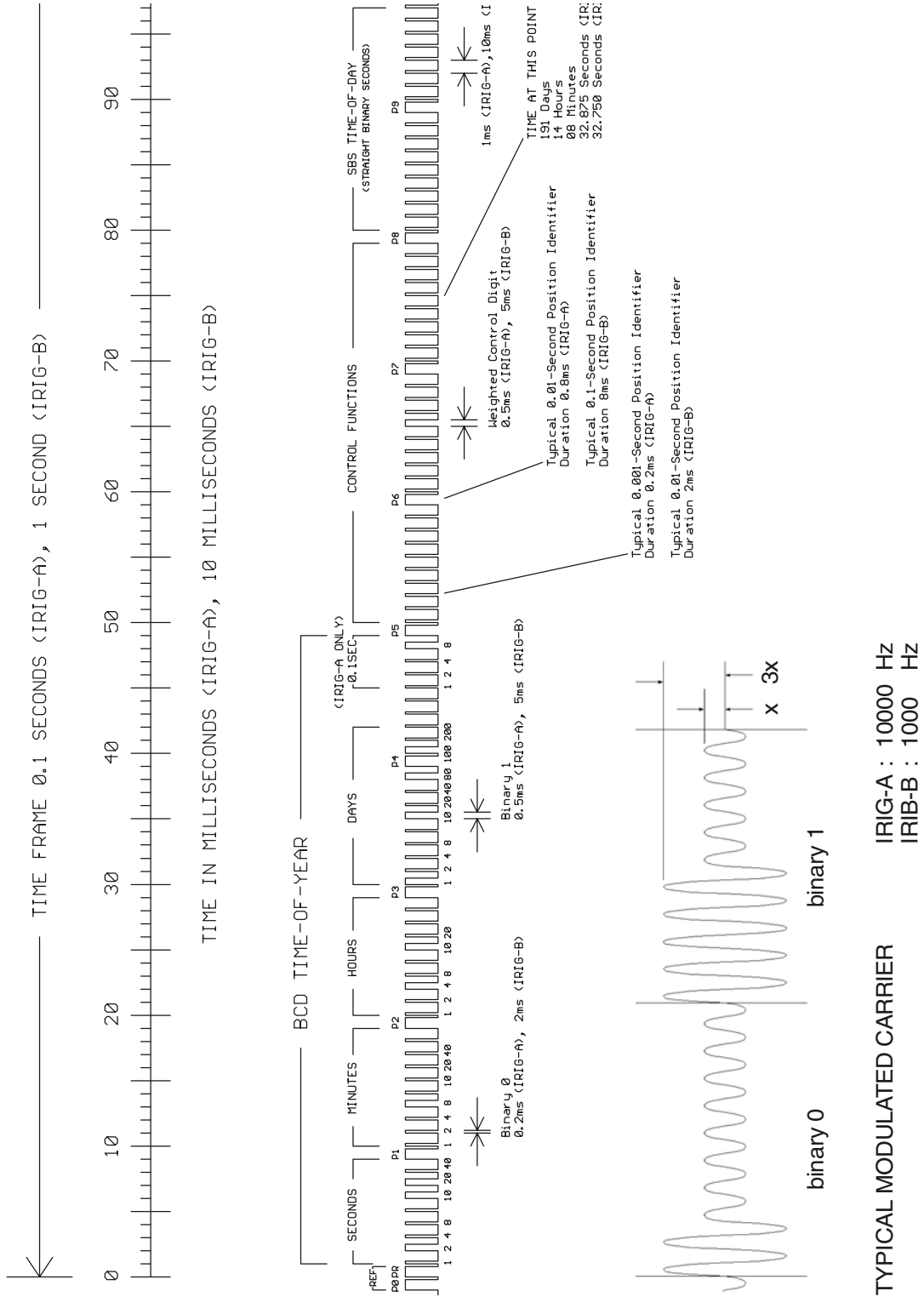



# AFNOR Standard Format

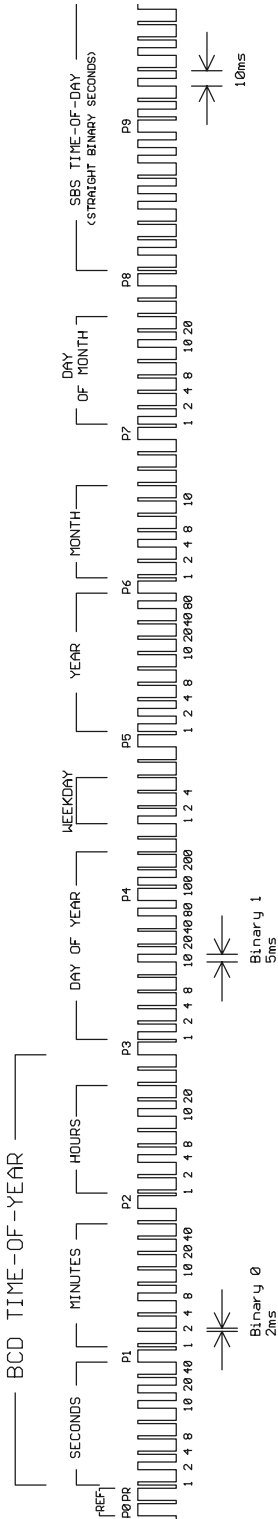

## Assignment of CF Segment in IEEE1344 mode

Bit No.	Designation	Description
49	Position Identifier P5	
50	Year BCD encoded 1	low nibble of BCD encoded year
51	Year BCD encoded 2	
52	Year BCD encoded 4	
53	Year BCD encoded 8	
54	empty, always zero	
55	Year BCD encoded 10	high nibble of BCD encoded year
56	Year BCD encoded 20	
57	Year BCD encoded 40	
58	Year BCD encoded 80	
59	Position Identifier P6	
60	LSP - Leap Second Pending	set up to 59s before LS insertion
61	LS - Leap Second	0 = add leap second, 1 = delete leap second <sup>1)</sup>
62	DSP - Daylight Saving Pending	set up to 59s before daylight saving changeover
63	DST - Daylight Saving Time	set during daylight saving time
64	Timezone Offset Sign	sign of TZ offset 0 = '+', 1 = '-'
65	TZ Offset binary encoded 1	Offset from IRIG time to UTC time. Encoded IRIG time plus TZ Offset equals UTC at all times !
66	TZ Offset binary encoded 2	
67	TZ Offset binary encoded 4	
68	TZ Offset binary encoded 8	
69	Position Identifier P7	
70	TZ Offset 0.5 hour	set if additional half hour offset
71	TFOM Time figure of merit	time figure of merit represents approximated clock error. <sup>2)</sup> 0x00 = clock locked 0x0F = clock failed
72	TFOM Time figure of merit	
73	TFOM Time figure of merit	
74	TFOM Time figure of merit	
75	PARITY	parity on all preceding bits incl. IRIG-B time
<sup>1)</sup> current firmware does not support deletion of leap seconds		
<sup>2)</sup> TFOM is cleared, when clock is synchronized first after power up. <i>see chapter Selection of generated timecode</i>		

## Generated Timecodes

Besides the amplitude modulated sine wave signal, the board also provides unmodulated DC-Level Shift TTL output in parallel. Thus six time codes are available.

- a) B002: 100pps, PWM DC signal, no carrier  
BCD time of year
- b) B122: 100pps, AM sine wave signal, 1 kHz carrier frequency  
BCD time of year
- c) B003: 100pps, PWM DC signal, no carrier  
BCD time of year, SBS time of day
- d) B123: 100pps, AM sine wave signal, 1 kHz carrier frequency  
BCD time of year, SBS time of day
- e) AFNOR: Code according to NFS-87500, 100pps,  
AM sine wave signal, 1kHz carrier frequency,  
BCD time of year, complete date, SBS time-of-day,  
Signal level according to NFS-87500
- f) IEEE1344: Code according to IEEE1344-1995, 100pps,  
AM sine wave signal, 1kHz carrier frequency,  
BCD time-of-year, SBS time of day, IEEE1344  
extensions for date, timezone, daylight-saving  
and leap second in control functions (CF) segment.  
*also see table 'Assignment of CF segment in IEEE1344 mode'*

## Selection of Generated Time Code

The time code to be generated can be selected using the GPSMON32 application. DC-Level Shift Codes (PWM signal) B00x and modulated sine wave carrier B12x are always generated simultaneously. Both signals are provided at the VG64-Connector, i.e. if code B132 is selected also code B002 is available. This applies for the codes AFNOR NFS 87-500 and IEEE1344 as well.

The TFOM field in IEEE1344 code is set dependent on the 'already sync'ed' character ('#') which is sent in the serial time telegram. This character is set, whenever the preconnected clock was not able to synchronize after power up reset. The 'time figure of merit' (TFOM) field is set as follows.

Clock synchronized once after power up	:	TFOM = 0000
Clock <u>not</u> synchronized after power up	:	TFOM = 1111

For testing purposes the output of TFOM in IEEE1344 mode can be disabled. In this case the complete segment is set to zero.

## Outputs

The module GPS167-TC provides modulated and unmodulated (DC-Level Shift) outputs. The format of the timecodes is illustrated "IRIG-" and "AFNOR standardformat".

### AM Sine Wave Output

The amplitude-modulated carrier is available at the VG connector pin 14a. The carrier frequency depends on the code and has a value of 1 kHz (IRIG-B). The signal amplitude is  $3V_{pp}$  (MARK) and  $1V_{pp}$  (SPACE) into  $50\ \Omega$ . The encoding is made by the number of MARK amplitudes during ten carrier waves. The following agreements are valid:

- |                        |   |                                       |
|------------------------|---|---------------------------------------|
| a) binary "0"          | : | 2 MARK amplitudes, 8 SPACE amplitudes |
| b) binary "1"          | : | 5 MARK amplitudes, 5 SPACE amplitudes |
| c) position-identifier | : | 8 MARK amplitudes, 2 SPACE amplitudes |

### PWM DC Outputs

The pulse width modulated DC signals labeled "IRIG" and "AFNOR standard format" are coexistent to the modulated output and is available at the VG connector pin 13a with TTL level.

## Technical Data

**Outputs:** Unbalanced AM sine wave signal:  
 $3V_{pp}$  (MARK) /  $1V_{pp}$  (SPACE) into  $50\Omega$

PWM signal: TTL, high and low active

## Signal Description GPS167 V7.x

Name	Pin	Function
GND	32a+c	Ground
VCC in (+5V)	1a+c	+5V supply
VCC in (+12V)	2a+c	+12V supply
VCC in (+5V)	3a+c	+5 V supply (TCXO / OCXO)
P_SEC out	6c	Pulse when second changes, TTL level, active high, length 200 msec
P_MIN out	8c	Pulse when minute changes, TTL level, active high, length 200 msec
/RESETaout	9c	RESET signal, Push/Pull up to +5V
Prog. Pulse out	10c-12c	programmable pulse, TTL level
100 kHz out	10a	100 kHz frequency output, TTL level
1 MHz out	11a	1 MHz frequency output, TTL level
10 MHz out	12a	10 MHz frequency output, TTL level
TIMECODE DC	13a	Timecode unmod. out
TIMECODE AM	14a	Timecode mod. out 3Vpp
DCF_MARK out	17c	DCF77 compatible second marks, TTL level active high, length 100/200 msec
TIME_SYN	19c	TTL output, HIGH level if synchronization has been achieved, LOW level after reset or in case of serious errors (e.g. antenna faulty)
F_SYNTH	21c	Synthesizer output, TTL-Pegel
F_SYNTH_OD	22c	Synthesizer output, Open Drain, max sink current to GND: 150mA
F_SYNTH_SIN	23c	Synthesizer output, sine-wave 1.5 V eff.
CAPx	27c, 28c	Time capture inputs (TTL), capture on falling slope
COMx TxD out		COMx RS-232 transmit data output
COMx RxD in		COMx RS-232 receive data input
SDA, SCL, SCL_EN (reserved)		internal serial control bus, for extension boards reserved, do not connect

## Rear Connector Pin Assignments GPS167 V7.x

	a	c
1	VCC in (+5V)	VCC in (+5V)
2	VCC in (+12V)	VCC in (+12V)
3	VDD in (TCXO/OCXO)	VDD in (TCXO/OCXO)
4	(reserved, FreqAdjust out)	
5		
6		P_SEC out
7		
8	(reserved, 10 MHz in)	P_MIN out
9		/RESET out
10	100 kHz out	ProgPulse0 out
11	1 MHz out	ProgPulse1 out
12	10 MHz out	ProgPulse2 out
13	TIME CODE DC out	SCL
14	TIME CODE AM out	SCL_EN
15	COM2 RxD in	SDA
16	COM2 TxD out	(reserved, P3.2)
17	COM3 RxD in	DCF_MARK out
18	COM3 TxD out	(reserved, Vref/TxD2 TTL)
19	GND	TIME_SYN out
20	GND	(reserved, P2.3)
21	GND	F_SYNTH out
22	GND	F_SYNTH_OD out
23	GND	F_SYNTH_SIN out
24	GND	COM1 TxD out
25	GND	
26	GND	COM0 TxD out
27	GND	CAP1 in
28	GND	CAP0 in
29	GND	COM1 RxD in
30	GND	COM0 RxD in
31	GND	GND
32	GND	GND

male connector according to DIN 41612, type C 64, rows a + c





## The GPSMON32 Configuration and Monitoring Application

The program GPSMON32 can be used to monitor and configure all essential functions of Meinberg GPS-Receivers. The Software is executable under Win9x, Win2000, WinXP and WinNT. To install GPSMON32 just run Setup.exe from the included diskette and follow the instructions of the setup program. The current version can be downloaded from the Meinberg website ([www.meinberg.de](http://www.meinberg.de)).

GPSMON32 and the clock can communicate either via serial link or via TCP/IP connection if the clock comes with a network interface (LANXPT or SCU-XPT module). The mode to be used can be selected in menu ,Connection->Settings' by selecting either serial or network.

### Serial Connection

To obtain a connection between your PC and the GPS-receiver, connect the receivers COM0 port to a free serial port of your PC. The PC's comport used by the program GPSMON32 can be selected in submenu '**PC-Comport**' of the '**Connection**' menu.

Additionally, transfer rate and framing used by the program are selectable within this menu. Communication between the clock and the PC is possible only if the GPS serial port is configured in the same way as the PC's comport. Optionally you can enforce an access, if the GPS serial port is not configured with appropriate parameters for communication. Select the menu item '**Enforce Connection**' in menu '**Connection**' and click '**Start**' in the appearing window. Some firmware versions of GPS167 do not support this way of setting up a connection. If '**Enforce Connection**' doesn't succeed apparently, please change the serial port parameter of GPS COM0 manually to the corresponding values you used for the serial port of your PC.

### Network Connection

Settings needed for a network connection can be done in menu ,Connection->Settings'.

To initiate a network connection from within GPSMON32, the mode ,network' must be selected. Furthermore the TCP/IP address of your LANXPT/SCUXPT-Module has to be entered in field ,IP-Address'. If the IP-Address is unknown, you can let the program query your network for available clocks by clicking the ,Find' button. A new connection can be set up by selecting to one of the found addresses (point and click). Network access to Meinberg radioclocks is always password protected, the default password is "Meinberg" (without quotes).

The Online Help function of GPSMON32 (F1) provides detailed information on setting up a TCP/IP connection.

## Online Help

The online help can be started by clicking the menu item 'Help' in menu Help. A direct access to a related help topic can be obtained everywhere by pressing the F1 key. The help language can be selected by clicking the menu items Deutsch/Englisch in the Help Menu.

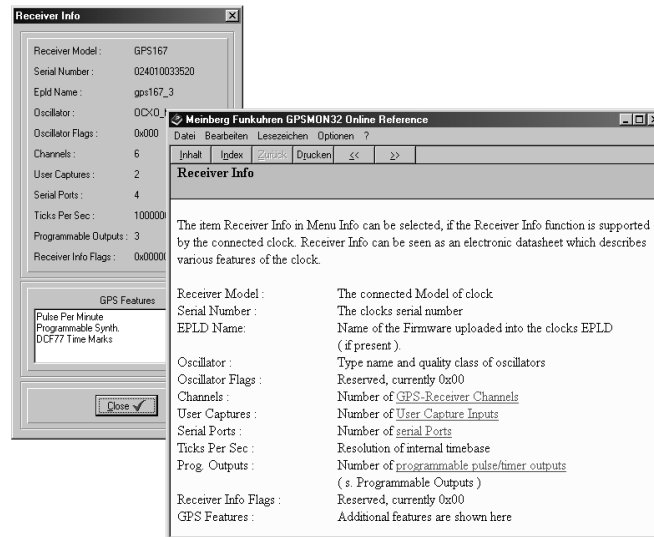

**Diskette with Windows Software GPSMON32**

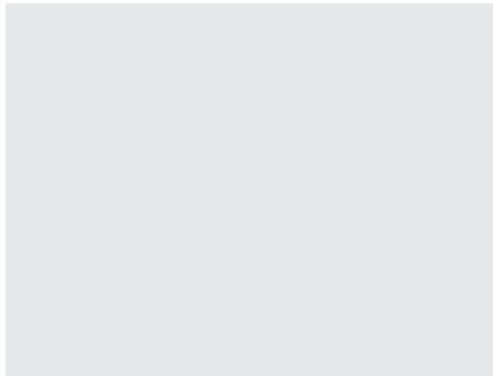

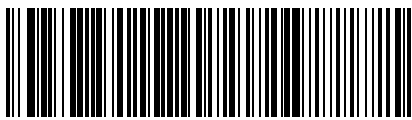

GPS167SV- E- 050506