

Technical Information
Operating Instructions
GPS167

Impressum

Meinberg Funkuhren GmbH & Co. KG
Auf der Landwehr 22
D-31812 Bad Pyrmont

Phone: +49 (0) 52 81 / 9309-0
Fax: +49 (0) 52 81 / 9309-30

Internet: <http://www.meinberg.de>
Email: info@meinberg.de

April 25, 2006

Table of Contents

Impressum	2
General Information	6
GPS167 Features	7
Time Zone and Daylight Saving	8
Pulse and Frequency Outputs	8
Time Capture Inputs	9
Asynchronous Serial Ports (optional 4x COM)	9
DCF77 Emulation	10
Programmable pulse (optional)	11
Timecode outputs (optional)	11
Abstract	11
Installation	12
Power Supply	12
Mounting the Antenna	12
Antenna Short-Circuit	13
Assembly with CN-UB/E (optional)	14
Powering Up the System	15
The Front Panel Layout	16
FAIL LED	16
LOCK LED	16
LC Display	16
MENU Key	16
CLR/ACK Key	16
NEXT Key	17
INC Key	17

The Menus in Detail	17
Root Menu	17
Menu RECEIVER POS.	19
Menu SV CONSTELLATION	19
Menu SV POSITION	20
Menu USER CAPTURE	20
Menu SETUP	20
SETUP FREQUENCY OUTPUT	21
SETUP ENABLE OUTPUTS	21
SETUP TIME ZONE	22
SETUP DAYLIGHT SAV ON/OFF	22
SETUP SERIAL PORT PARM	23
SETUP SERIAL STRING TYPE	24
SETUP SERIAL STRING MODE	24
SETUP POUT X (optional)	25
Mode	25
Timer mode	25
Single Pulse	26
Cyclic mode	26
PPS, PPM, PPH Modes	26
Menu Quick Reference for progr. Pulse	27
SETUP IRIG SETTINGS (optional)	28
SETUP INITIAL POSITION	28
SETUP INITIAL TIME	29
INIT USER PARMS	29
INIT GPS PARMS	29
FORCE BOOT MODE	30
ANTENNA CABLE	30
Resetting Factory Defaults	31

Firmware Updates	31
Skilled/Service-Personnel only: Replacing the Lithium Battery	32
CE Label	32
Technical Specifications GPS167	33
Oscillator specifications	35
Technical Specifications GPS167 Antenna	36
Time Strings	37
Format of the Meinberg Standard Time String	37
Format of the Meinberg Capture String	38
Format of the SAT Time String	39
Format of the Uni Erlangen String (NTP)	40
Format of the NMEA 0183 String (RMC)	42
Format of the ABB SPA Time String	43
Format of the Computime Time String	44
Timecode (optional)	45
Principle of Operation	45
Block Diagram Timecode	45
IRIG Standard Format	46
AFNOR Standard Format	47
Assignment of CF Segment in IEEE1344 mode	48
Generated Timecodes	49
Selection of Generated Time Code	50
Outputs	50
AM Sine Wave Output	50
PWM DC Outputs	50
Technical Data	51
Signal Description GPS167 V7.x	52
Rear Connector Pin Assignments GPS167 V7.x	53
Menu Quick Reference	55

General Information

The satellite receiver clock GPS167 has been designed to provide extremely precise time to its user. The clock has been developed for applications where conventional radio controlled clocks can't meet the growing requirements in precision. High precision available 24 hours a day around the whole world is the main feature of the new system which receives its information from the satellites of the Global Positioning System.

The Global Positioning System (GPS) is a satellite-based radio-positioning, navigation, and time-transfer system. It was installed by the United States Department of Defense and provides two levels of accuracy: The Standard Positioning Service (SPS) and the Precise Positioning Service (PPS). While PPS is encrypted and only available for authorized (military) users, SPS has been made available to the general public.

GPS is based on accurately measuring the propagation time of signals transmitted from satellites to the user's receiver. A nominal constellation of 21 satellites together with several active spares in six orbital planes 20000 km over ground provides a minimum of four satellites to be in view 24 hours a day at every point of the globe. Four satellites need to be received simultaneously if both receiver position (x, y, z) and receiver clock offset from GPS system time must be computed. All the satellites are monitored by control stations which determine the exact orbit parameters as well as the clock offset of the satellites' on-board atomic clocks. These parameters are uploaded to the satellites and become part of a navigation message which is retransmitted by the satellites in order to pass that information to the user's receiver.

The high precision orbit parameters of a satellite are called ephemeris parameters whereas a reduced precision subset of the ephemeris parameters is called a satellite's almanac. While ephemeris parameters must be evaluated to compute the receiver's position and clock offset, almanac parameters are used to check which satellites are in view from a given receiver position at a given time. Each satellite transmits its own set of ephemeris parameters and almanac parameters of all existing satellites.

GPS167 Features

The hardware of GPS167 is a 100mm x 160mm microprocessor board. The 105mm wide front panel integrates a 4 x 16 character LC display, two LED indicators and 4 push buttons. The receiver is connected to the antenna/converter unit by a 50 ohm coaxial cable (refer to "Mounting the Antenna"). Feeding the antenna/converter occurs DC insulated via the antenna cable. Optional an antenna splitter for up to four receivers connected to one antenna is available.

GPS167 is using the "Standard Positioning Service" SPS. The navigation message coming in from the satellites is decoded by GPS167's microprocessor in order to track the GPS system time. Compensation of the RF signal's propagation delay is done by automatical determination of the receiver's position on the globe. A correction value computed from the satellites' navigation messages increases the accuracy of the board's oven controlled master oscillator (OCXO) and automatically compensates the OCXO's aging. The last recent value is restored from the battery buffered memory at power-up.

The GPS167 provides different optional outputs, i.e. three programmable pulse outputs, modulated/unmodulated timecode output, and up to a total of four RS232 COM ports. Additionally, you can order the GPS167 with different OCXOs (e.g. OCXO-LQ / MQ / HQ or an external Rubidium) to match the required accuracy.

The hard- and software configuration of the clock is displayed if the NEXT key is pressed two times from the root menu.

Time Zone and Daylight Saving

GPS system time differs from the universal time scale UTC (Universal Time Coordinated) by the number of leap seconds which have been inserted into the UTC time scale after GPS has been initiated in 1980. The current number of leap seconds is part of the navigation message supplied by the satellites, so GPS167's internal real time is based on UTC. Conversion to local time including handling of daylight saving year by year can be done by the receiver's microprocessor if the corresponding parameters are set up by the user.

Pulse and Frequency Outputs

The pulse generator of GPS167 generates pulses once per second (P_SEC) and once per minute (P_MIN). Additionally, master frequencies of 10 MHz, 1 MHz and 100 kHz are derived from the OCXO. All the pulses are available with TTL level at the rear connector. The included synthesizer generates a frequency from 1/8 Hz up to 10 MHz synchronous to the internal timing frame. The phase of this output can be shifted from -360° to $+360^\circ$ for frequencies less than 10 kHz. Both frequency and phase can be setup from the front panel or using the serial port COM0. Synthesizer output is available at the rear connector as sine-wave output (F_SYNTH_SIN), with TTL level (F_SYNTH) and via an open drain output (F_SYNTH_OD). The open drain output can be used to drive an optocoupler when a low frequency is generated.

In the default mode of operation, pulse outputs and the synthesizer output are disabled until the receiver has synchronized after power-up. However, the system can be configured to enable those outputs immediately after power-up. An additional TTL output (TIME_SYN) reflects the state of synchronization. This output switches to TTL HIGH level when synchronization has been achieved and returns to TTL LOW level if not a single satellite can be received or the receiver is forced to another mode of operation by the user.

Time Capture Inputs

Two time capture inputs called User Capture 0 and 1 are provided at the rear connector (CAP0 and CAP1) to measure asynchronous time events. A falling TTL slope at one of these inputs lets the microprocessor save the current real time in its capture buffer. From the buffer, capture events are transmitted via COM0 or COM1 and displayed on LCD. The capture buffer can hold more than 500 events, so either a burst of events with intervals down to less than 1.5 msec can be recorded or a continuous stream of events at a lower rate depending on the transmission speed of COM0 or COM1 can be measured. The format of the output string is ASCII, see the technical specifications at the end of this document for details. If the capture buffer is full a message "*** capture buffer full" is transmitted, if the interval between two captures is too short the warning "*** capture overrun" is being sent.

Asynchronous Serial Ports (optional 4x COM)

Four asynchronous serial RS232 interfaces (COM0 ... COM3) are available to the user. In the default mode of operation, the serial outputs are disabled until the receiver has synchronized after power-up. However, the system can be configured to enable those outputs immediately after power-up. Transmission speeds, framings and mode of operation can be configured separately using the setup menu. COM0 is compatible with other radio remote clocks made by Meinberg. It sends the time string either once per second, once per minute or on request with ASCII '?' only. Also the interfaces can be configured to transmit capture data either automatically when available or on request. The format of the output strings is ASCII, see the technical specifications at the end of this document for details. A separate document with programming instructions can be requested defining a binary data format which can be used to exchange parameters with GPS167 via COM0.

DCF77 Emulation

The GPS167 satellite controlled clock generates TTL level time marks (active HIGH) which are compatible with the time marks spread by the German long wave transmitter DCF77. This long wave transmitter installed in Mainflingen near Frankfurt/Germany transmits the reference time of the Federal Republic of Germany: time of day, date of month and day of week in BCD coded second pulses. Once every minute the complete time information is transmitted. However, GPS167 generates time marks representing its local time as configured by the user, including announcement of changes in daylight saving and announcement of leap seconds. The coding scheme is given below:

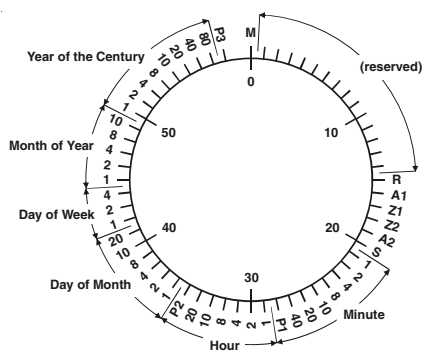

M	Start of Minute (0.1 s)
R	RF Transmission via secondary antenna
A1	Announcement of a change in daylight saving
Z1, Z2	Time zone identification
	Z1, Z2 = 0, 1: Daylight saving disabled
	Z1, Z2 = 1, 0: Daylight saving enabled
A2	Announcement of a leap second
S	Start of time code information
P1, P2, P3	Even parity bits

Time marks start at the beginning of new second. If a binary "0" is to be transmitted, the length of the corresponding time mark is 100 msec, if a binary "1" is transmitted, the time mark has a length of 200 msec. The information on the current date and time as well as some parity and status bits can be decoded from the time marks of the 15th up to the 58th second every minute. The absence of any time mark at the 59th second of a minute signals that a new minute will begin with the next time mark. The DCF emulation output is enabled immediately after power-up.

Programmable pulse (optional)

At the male connector Typ VG64 there are three programmable TTL outputs (Prog Pulse 0-2), which are arbitrarily programmable.

Other technical details are described at the end of this manual.

Timecode outputs (optional)

Abstract

The transmission of coded timing signals began to take on widespread importance in the early 1950's. Especially the US missile and space programs were the forces behind the development of these time codes, which were used for the correlation of data. The definition of time code formats was completely arbitrary and left to the individual ideas of each design engineer. Hundreds of different time codes were formed, some of which were standardized by the "Inter Range Instrumentation Group" (IRIG) in the early 60's.

Except these "IRIG Time Codes", other formats like NASA36, XR3 or 2137 are still in use. The board GPS167 however generates the IRIG-B, AFNOR NFS 87-500 code as well as IEEE1344 code which is an IRIG-B123 coded extended by information for time zone, leap second and date. Other formats may be available on request.

At the male connector Typ VG64 there are also IRIG-B modulated (3Vpp into 50 Ohm) and IRIG-B unmodulated DC level shift.

Installation

Power Supply

The power supply used with GPS167 has to provide only one output of +5V. The output voltage should be well regulated because drifting supply voltages reduce the short time accuracy of the generated frequencies and timing pulses. The power supply lines should have low resistance and be connected using both pins a and c of the rear connector.

Mounting the Antenna

The GPS satellites are not stationary but circle round the globe in a period of about 12 hours. They can only be received if no building is in the line-of-sight from the antenna to the satellite, so the antenna/converter unit must be installed in a location from which as much of the sky as possible can be seen. The best reception is given when the antenna has a free view of 8° angular elevation above horizon. If this is not possible the antenna should be installed with a mostly free view to the equator because of the satellite courses which are located between latitudes of 55° North and 55° South. If even this is not possible problems occur especially when at least four satellites for positioning have to be found.

The antenna/converter unit can be mounted on a pole with a diameter up to 60 mm or at a wall. A 50cm plastic tube, two holders for wall-mounting and clamps for pole-mounting are added to every GPS167. A standard coaxial cable with 50 ohms impedance should be used to connect the antenna/converter unit to the receiver. The maximum length of cable between antenna and receiver depends on the attenuation factor of the used coaxial cable.

Example:

Type of cable	diameter Ø [mm]	Attenuation at 100MHz [dB]/100m	max. length [m]
RG58/CU	5mm	15.9	300 ¹
RG213	10.5mm	6.9	700 ¹
1) These specifications are made for antenna/converter units produced after January, 2005			
The values are typically ones; the exact ones are to find out from the data sheet of the used cable.			

Up to four GPS167 receivers can be run with one antenna/converter unit by using the optional antenna diplexer. The total length of one antenna line between antenna, diplexer and receiver must not be longer than the max. length shown in the table above. The position of the diplexer in the antenna line does not matter.

When installing the high voltage protector CN-UB/E (CN-UB-280DC) be aware to set it directly after reaching indoor. The CN-UB/E is not for outdoor usage.

Antenna Short-Circuit

In case of an antenna line short-circuit the following message appears in the display:



If this message appears the clock has to be disconnected from the mains and the defect is to eliminate. After that the clock can be powered-up again. The antenna supply voltage must be in a range of $18.5V_{DC}$ (free) and $16V_{DC}$ (connected GPS antenna).

Assembly with CN-UB/E (optional)

Optional the overvoltage protector CN-UB/E is available. Standard you connect the antenna converter directly with the antenna cable to the system.

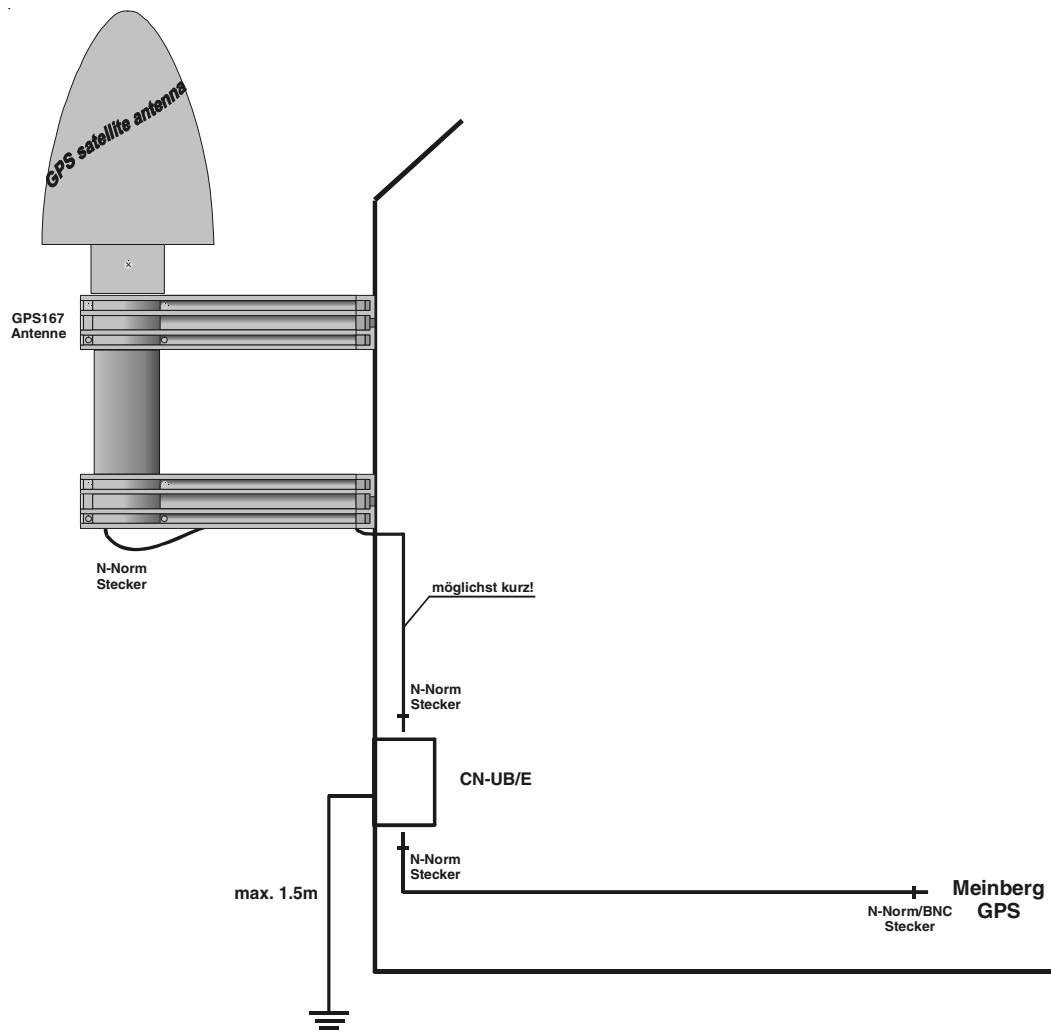

Powering Up the System

If both the antenna and the power supply have been connected the system is ready to operate. About 10 seconds after power-up the receiver's (OCXO-LQ) until 3 minutes (OCXO-MQ / HQ) has warmed up and operates with the required accuracy. If the receiver finds valid almanac and ephemeris data in its battery buffered memory and the receiver's position has not changed significantly since its last operation the receiver can find out which satellites are in view now. Only a single satellite needs to be received to synchronize and generate output pulses, so synchronization can be achieved maximally one minute after power-up (OCXO-LQ) until 10 minutes (OCXO-MQ / HQ) . After 20 minutes of operation the OCXO is full adjusted and the generated frequencies are within the specified tolerances.

If the receiver position has changed by some hundred kilometers since last operation, the satellites' real elevation and doppler might not match those values expected by the receiver thus forcing the receiver to start scanning for satellites. This mode is called **Warm Boot** because the receiver can obtain ID numbers of existing satellites from the valid almanac. When the receiver has found four satellites in view it can update its new position and switch to **Normal Operation**. If the almanac has been lost because the battery had been disconnected the receiver has to scan for a satellite and read in the current almanacs. This mode is called **Cold Boot**. It takes 12 minutes until the new almanac is complete and the system switches to **Warm Boot** mode scanning for other satellites.

In the default mode of operation, neither pulse and synthesizer outputs nor the serial ports will be enabled after power-up until synchronization has been achieved. However, it is possible to configure some or all of those outputs to be enabled immediately after power-up. If the system starts up in a new environment (e. g. receiver position has changed or new power supply) it can take some minutes until the OCXO's output frequency has been adjusted. Up to that time accuracy of frequency drops to 10^{-8} reducing the accuracy of pulses to $\pm 5\mu\text{s}$.

The Front Panel Layout

FAIL LED

The FAIL LED is turned on whenever the TIME_SYN output is low (receiver is not synchronized).

LOCK LED

The LOCK LED is turned on when after power-up the receiver has acquired at least four satellites and has computed its position. In normal operation the receiver position is updated continuously as long as at least four satellites can be received.

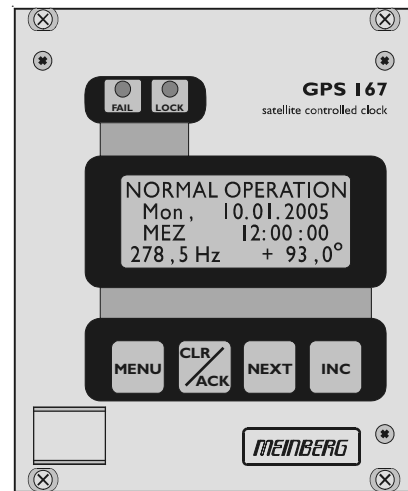

LC Display

The 4 x 16 character LC display is used to show the receiver's status and let the user edit parameters. The keys described below let the user select the desired menu. The next chapter lists all available menus in detail. A quick reference of the available menus and submenus can be found at the end of this document.

MENU Key

This key lets the user step through several display menus showing specific data.

CLR/ACK Key

This key has to be used when parameters are to be modified. When this key is pressed the parameters that have been edited are saved in the battery buffered memory. If the menu is left without pressing CLR/ACK all changes are discarded.

NEXT Key

When editing parameters (LCD cursor is visible) this key moves the cursor to the next digit resp. to the next parameter to be edited. If the current menu just displays data (cursor not visible) pressing this key switches to a submenu (if available).

INC Key

When editing parameters this key increments the digit or letter at the cursor position.

The Menus in Detail

Root Menu

The root menu is shown when the receiver has completed initialization after power-up. The first line of the display shows the receiver's mode of operation as described above. The text "NORMAL OPERATION" might be replaced by "COLD BOOT", "WARM BOOT", "UPDATE ALMANAC". If the antenna is disconnected or not working properly, the text "ANTENNA FAULTY" is displayed instead.



```
NORMAL OPERATION
MON 10.01.2005
MEZ 12:00:00
278.5Hz + 93.0°
```

The next two lines display the current date, the name of the time zone (as defined in the setup menu) and local time. The last line shows the state of the synthesizer. It might look like following:

- | | |
|---------------------|-----------------------------------------------------------------------------------------------------------------------------------------------------------------------------------------------------------------------------------|
| "Synth disabled" | Synthesizer is disabled (frequency setted on 0.000) |
| "F.synth inhibited" | GPS167 is not synchronized jet, but the synthesizer will be enabled after synchronisation. |
| ".....(free)" | The frequency is generated, but the phase is not synchronous to the pulse output P_SEC, either because the synthesizer is enabled although GPS167 has not synchronized jet or because the frequency is setted to more than 10kHz. |

".....(drft)" The frequency is generated and the phase was already synchronous to the pulse output P_SEC, but in the moment the phase can't be controlled or adjusted because no satellite is received now.

If the NEXT key is pressed one time from the root menu a submenu is displayed showing the receiver's software revision:

```
Meinberg GPS167
S/N 0240100xxx50
Rev. 4.xx
```

If the NEXT key is pressed for second time a submenu is displayed showing other receiver's infos

```
RECEIVER INFO
PROUT: 0 NCOM: 2
SYNTH: variable
OCXO_LQ gps167_i
```

Meaning of the abbreviations and adjusted standard value:

- "PROUT: 0" programmable pulse
 standard: 0 (not available)
 optional: 3 (until three prog. pulse)

- "NCOM: 2" serial interface
 standard: 2 (COM0 and COM1)
 optional: 4 (COM0 - 3)

- "SYNTH: variable" frequency synthesizer
 standard: available
 optional: N/A (only TCXO)

- "OCXO_LQ" used oscillator (see Oscillator specifications)

- "GPS167_i" EPLD Version

Menu RECEIVER POS.

This menu shows the current receiver position. The NEXT key lets the user select one of three formats. The default format is geographic latitude, longitude and altitude with latitude and longitude displayed in degrees, minutes and seconds. The next format is geographic, too, with latitude and longitude displayed in degrees with fractions of degrees. The third format displays the receiver position in earth centered, earth fixed coordinates (ECEF coordinates). The three formats are shown below:

RECEIVER POS Lat: 51°58'58" N Lon: 9°13'34" E Alt: 143 m	RECEIVER POS Lat: 51.9827° Lon: 9.2253° Alt: 143 m	RECEIVER POS x: 3885618 m y: 631097 m z: 5001697 m
-------------------------------------------------------------------	-------------------------------------------------------------	-------------------------------------------------------------

Menu SV CONSTELLATION

The SV constellation menu gives an overview of the current satellites (SVs) in view. The second line of the display shows the number of satellites with an elevation of 5° or more. The third line gives the number of satellites that can be used for navigation whereas the last line shows the selected set of satellites which are used to update the receiver position.

SV CONSTELLATION SVs in view: 6 Good SVs: 4 Sel: 1 12 13 24

The precision of the computed receiver position and time is affected by the geometric constellation of the four satellites being used. A set of values called dilutions of precision (DOP) can be computed from the geometric constellation. Those values can be displayed in a submenu of the SV constellation menu. PDOP is the position dilution of precision, TDOP is the time dilution of precision, and GDOP, computed from the others above, is the general dilution of precision. Lower DOP values mean more precision.

DILUTION OF PREC PDOP: 3.82 TDOP: 1.12 GDOP: 4.00

Menu SV POSITION

This menu gives information on the currently selected satellite (SV). The satellite's ID number, its elevation, azimuth and distance from the receiver position reflect the satellite's position in the sky whereas the doppler shows whether the satellite is coming up from the horizon (doppler positive) or going down to the horizon (doppler negative). All satellites in view can be monitored by using the NEXT key.

```
SV 12  INFO:
El: 6°   Az: 120°
Dist:   22073 km
Dopp:   +2.157 kHz
```

Menu USER CAPTURE

The time of the last recent capture event is displayed in this menu. The time zone depends on the parameters entered in the setup menu (see below). The NEXT key lets the display toggle between the two capture channels. If an error message ("Cap. Overrun" or "Cap. Buffer Full") is displayed in the second line it can be acknowledged pressing the CLR/ACK key.

```
USER CAPTURE 0
MEZ   07.01.2002
12 : 00 : 00.0000002
```

```
USER CAPTURE 1
MEZ   07.01.2002
12 : 00 : 00.0000002
```

Menu SETUP

From this menu, several topics can be selected which let the user edit parameters or force special modes of operation. A specific topic can be selected using the NEXT key. Depending on the current topic, pressing the CLR/ACK key either enters edit mode with the selected set of parameters or switches to the selected mode of operation (after the user has acknowledged his decision). Once edit mode has been entered, the NEXT key lets the cursor move to the digit or letter to be edited whereas the INC key increments the digit or letter under the cursor. If changes have been made, the CLR/ACK key must be pressed in order to save those changes in the battery buffered memory, otherwise all changes are discarded when the user presses the MENU key in order to return to the SETUP display.

SETUP FREQUENCY OUTPUT

This setup menu lets the user edit the frequency and phase to be generated by the on-board synthesizer. Frequencies from 1/3Hz up to 10MHz can be entered using four digits and a range. The range can be selected if the INC key is pressed while the cursor is positioned on the frequency's units string. If the least significant range has been selected valid fractions of the frequency are .0, .1 (displayed as 1/8), .2 (displayed as 1/4), .3 (displayed as 1/3), .5 and .6 (displayed as 2/3). Selection of 1/3 or 2/3 means real 1/3 or 2/3 Hz, not 0.33 or 0.66. If other fractions than those listed above are entered, an error message "(inval. frac.)" is displayed. In the upper ranges any fraction can be entered. If frequency is set to 0 the synthesizer is disabled.

The last line of the display lets the user enter the phase of the generated frequency from -360° to $+360^\circ$ with a resolution of 0.1° . Increasing the phase lets the signal come out later. Phase affects frequencies less than 10.00 kHz only, if a higher frequency is selected a message "(phase ignored)" informs the user that the phase value is ignored. The synthesizer is re-initialized with the parameters on the display if the CLR/ACK key is pressed.

SETUP
FREQUENCY OUTPUT

FREQUENCY OUTPUT
Freq: 287.5 Hz
Phase: +093.0° el

SETUP ENABLE OUTPUTS

This menu lets the user configure at which time after power up the serial ports, pulse outputs, and frequency synthesizer output are to be enabled. Outputs which are shown to be enabled **always** will be enabled immediately after power-up. Outputs which are shown to be enabled **if sync** will be enabled after the receiver has decoded the signals from the satellites and has checked or corrected its on-board clock. The default setting for all outputs is **if sync**.

SETUP
ENABLE OUTPUTS

ENABLE OUTPUTS
Serial: always
Pulses: if sync
Synth: if sync

SETUP TIME ZONE

This menu lets the user enter the names of the local time zone with daylight saving disabled and enabled, together with the zones' time offsets from UTC. The left part of the display shows the zone and offset if daylight saving is off whereas the right part shows name and offset if daylight saving is on. These parameters are used to convert UTC to local time, e.g. MEZ = UTC + 1h and MESZ = UTC + 2h for central europe. The range of date daylight saving comes in effect can be entered using the next two topics of the setup menu.

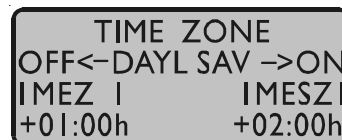
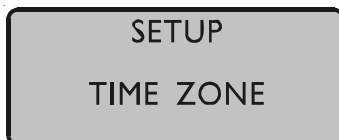

SETUP DAYLIGHT SAV ON/OFF

The two topics let the user enter the range of date for daylight saving to be in effect. Concerning parameter input both topics are handled identically, so they are described together in this chapter. Beginning and ending of daylight saving may either be defined by exact dates for a single year or using an algorithm which allows the receiver to recompute the effective dates year by year. The figures below show how to enter parameters in both cases. If the number of the year is displayed as wildcards ('*'), a day-of-week must be specified. Then, starting from the configured date, daylight saving changes the first day which matches the configured day-of-week. In the figure below March 25, 2000 is a Saturday, so the next Sunday is March 26, 2000.

All changeover rules for the daylight saving like "the first/the second/the second to last/the last Sunday/Monday etc. in the x-th month," can be described by the used format "first specified day-of-week after a defined date".

If the number of the year is not displayed as wildcards the complete date exactly determines the day daylight saving has to change (March 28, 1999 in the figures below), so the day-of-week doesn't need to be specified and therefore is displayed as wildcards.



changeover date for
a single year

changeover the last
Sunday in March/October
each year

If no changeover in daylight saving is wanted, an identical date and time must be configured in both of the submenus (see fig. below). In addition identical offsets for DAYLIGHT SAV ON/OFF should be configured in the submenu TIMEZONE.

SETUP
DAYLIGHT SAV ON

DAYLIGHT SAV ON
Date: 26.03.2000
Day of week: ***
Time: 2:00:00

SETUP
DAYLIGHT SAV OFF

DAYLIGHT SAV OFF
Date: 26.03.2000
Day of week: ***
Time: 2:00:00

SETUP
TIME ZONE

TIME ZONE
OFF<-DAYL SAV ->ON
|TIME| |TIME|
+08:00h +08:00h

(Example for a region without daylight saving time and with a local time offset of +8 hours to UTC.)

SETUP SERIAL PORT PARM

Using this topic the user can enter transmission speed and framing of each serial port. Default parameters are:

COM0:	19200 baud, 8N1	COM2:	9600 baud, 8N1
COM1:	9600 baud, 8N1	COM3:	9600 baud, 8N1

Annotation: Even if one of the setup functions "INIT USER PARMS" or "Resetting Factory Defaults" is executed, the serial port parameters are reset to default values only if invalid parameters have been configured.

SETUP
SERIAL PORT PARMS

COM 0: 19200 8N1
COM 1: 9600 8N1
COM 2: 9600 8N1
COM 3: 9600 8N1

SETUP SERIAL STRING TYPE

This topic is used to select one of several different types of serial time strings or the capture string for each serial port. Default parameters are:

COM0:	Meinberg	COM2:	Meinberg
COM1:	Capture	COM3:	Meinberg

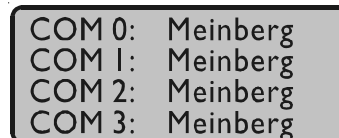
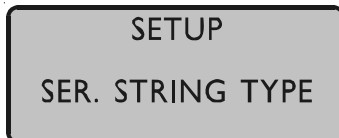

The following time strings can be selected:

- Meinberg Standard String
- GPS167 Capture String
- SAT String
- UNI-Erlangen String
- NMEA String (RMC)
- SPA String
- Computime String

Other technical details are described at the end of this manual.

SETUP SERIAL STRING MODE

This menu lets the user select the serial ports' mode of operation. The possible modes depend on the selected output string. If a time string is selected it can be sent automatically "Per Second", "Per Minute" or only "On Request" (sending an ASCII "?" to the clock). If the capture string is selected it can be sent automatically when a trigger event occurs ("String Auto") or only "On Request" (sending an ASCII "?" to the clock). If capture message "On Request" is selected it is the user's responsibility to read out the capture buffer by sending an ASCII "?" to COMx or by the binary protocol via COM0 in order to avoid a buffer-overflow and the loss of new trigger events.

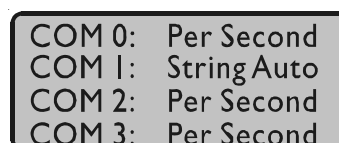
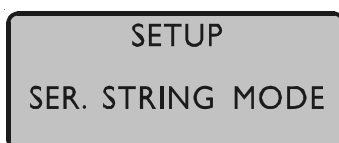

SETUP POUT X (optional)

This menu is used for configuration of the pulse outputs. There are three pulse outputs available (POUT 1-3).

```
SETUP
POUT X
```

```
SETUP POUT X
MODE: POUT OFF
AKT. : HIGH
LNG  : 00.00
```

Mode

This field selects the mode of operation of an output. Possible modes are POUT OFF, POUT TIMER, SINGLE PULSE, CYCLIC PULSE, PPS, PPM and PPH.

Timer mode

```
SETUP POUT 1
MODE: POUTTIMER
AKT. : HIGH
TIME : 1(-3)
```

```
TIMER
TIME: 1
ON  : 10:50:00
OFF : 11:00:00
```

```
TIMER
TIME: 2
ON  : 13:00:00
OFF : 14:00:00
```

```
TIMER
TIME: 3
ON  : 10:45:00
OFF : 09:30:00
```

If Timer mode is selected, a window as shown above is displayed. The switching plan is assigned per day. Three turn-on and turn-off times are programmable for each output. If a switching time has to be configured, only the turn-on and turn-off time must be programmed. Thus the example shows switching times from 10.50 to 11.00, 13.00 to 14.00 and 23.45 to 23.50. A turn-off time earlier than the turn-off time would cause the output to be enabled over midnight. For example a program '**On Time**' 10.45.00, '**Off Time**' 9.30.00 would cause an active output from 10.45 to 9.30 (the next day!). If one or more of the three switching times are unused just enter the same time into the fields '**On Time**' and '**Off Time**'. In this case the switch time does not affect the output.

Single Pulse

Selecting **Single Pulse** generates a single pulse of defined length once per day.

```
SETUP POUT I
MODE: SING.PULS
AKT. : HIGH
LNG. : 00.10
```

```
SINGLE SHOT
TIME: 12:00:00
```

You can enter the time when the pulse is generated in the field '**Single Shot Time**'. The value in field '**Length**' determines the pulse duration. A pulse duration from 10 msec to 10 sec in steps of 10 msec can be selected.

The example shows a single pulse at 12:00 every day with a duration of 100 ms.

Cyclic mode

Cyclic mode is used for generating periodically repeated pulses.

```
SETUP POUT I
MODE: CICL.PULS
AKT. : HIGH
LNG. : 00.10 sec
```

```
CYCLE
TIME: 0:00:02
```

The value in field '**Cycle Time**' determines the time between two consecutive pulses (2 sec in example above). This cycle time must be entered as hours, minutes and seconds. The pulse train is synchronized at 0:00 o'clock local time, so the first pulse of a day always occurs at midnight. A cycle time of 2 seconds for example, would cause pulses at 0:00:00, 0:00:02, 0:00:04 etc. Basically it is possible to enter any cycle time between 0 and 24 hours, however only a cycle times that causes a constant distance between all consecutive pulses make sense. For example a cycle time of 1 hour 45 minutes would generate a pulse every 6300 seconds (starting from 0 o'clock). The duration between the last pulse of a day and the first pulse of the next day (0:00:00 o'clock) would only be 4500 sec.

PPS, PPM, PPH Modes

These modes generate pulses of defined length once per second, once per minute or one per hour. '**Single Shot Time**' determines the pulse duration (10 msec...10 sec). *The respective output remains in active state, when selecting a pulse duration longer than 990ms in pulse per sec mode.*

Menu Quick Reference for progr. Pulse

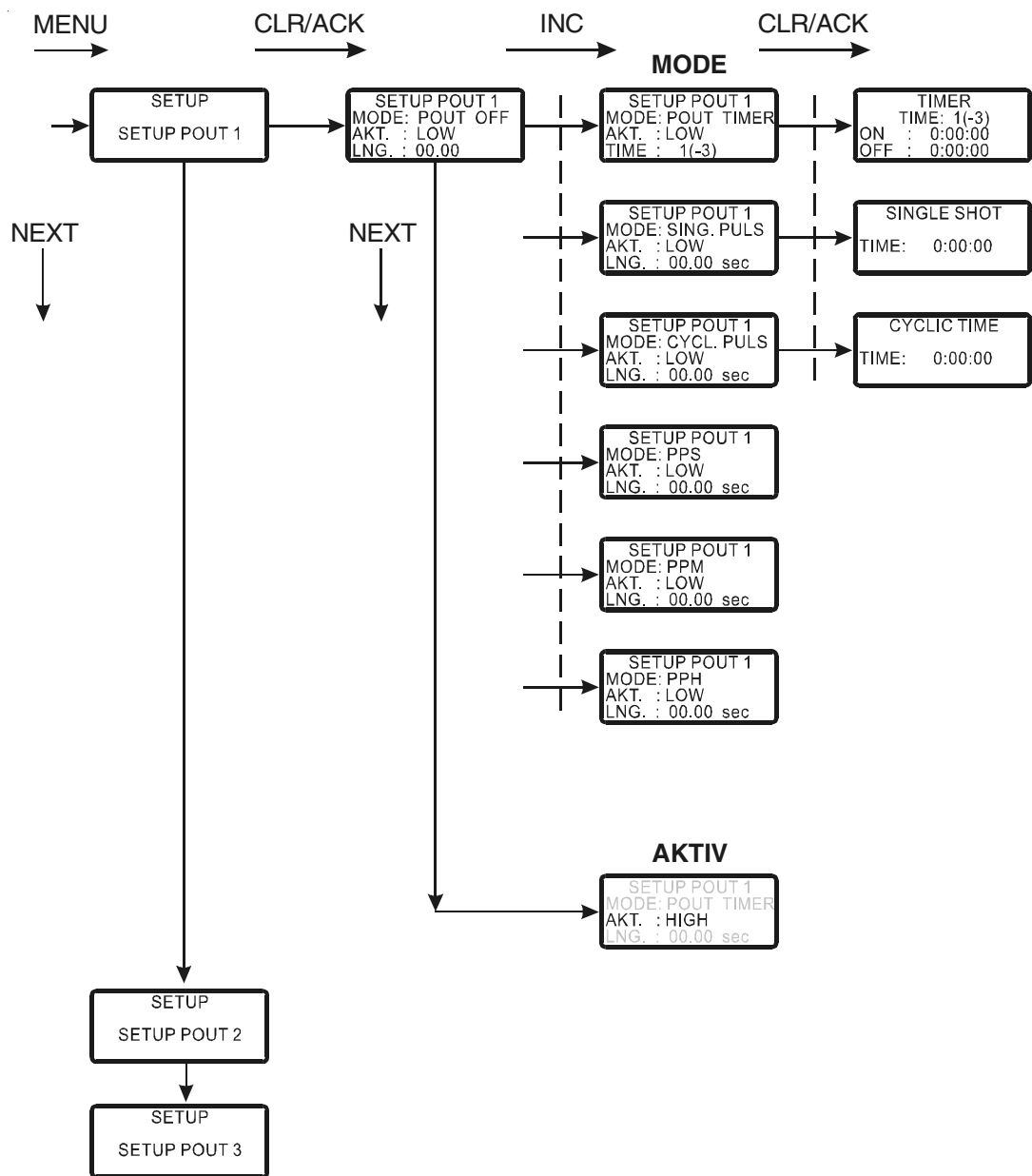

SETUP IRIG SETTINGS (optional)

This menu lets the user select the timecodes to be generated by GPS167. Most IRIG codes do not carry any time zone information, hence UTC is selected for output by default. If desired, the clock's local time can be output by selecting "TIME: LOCAL".

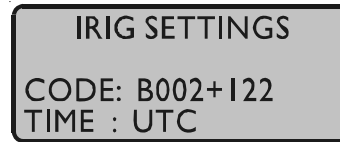

The IEEE1344 has a so called TFOM (time figure of merit) segment that carries an information on the synchronization state of the radio clock.

Whenever the selected timecode carries TFOM, it can be blanked by selecting "disable TFOM", This feature can be helpful for testing when the connected IRIG reader evaluates TFOM.

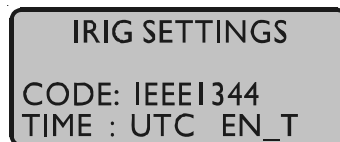

SETUP INITIAL POSITION

When the receiver is primarily installed at a new location far away from the last position saved in the receiver's memory the satellites in view and their dopplers will differ so much from those expected due to the wrong position that GPS167 has to scan for satellites in Warm Boot mode. Making the new approximately known position available to the receiver can avoid Warm Boot and speed up installation.



SETUP INITIAL TIME

If the receiver's on-board real time clock keeps a wrong time the receiver is unable to compute the satellites' correct elevation angles and dopplers. This submenu enables the user to change the receiver's system time for initialization. After the receiver has locked, its real time clock will be adjusted using the information from the satellites.

SETUP
SET INITIAL TIME

SET INITIAL TIME
MESZ
Date: 07.01.2002
Time: 12:00:00

INIT USER PARMS

This menu lets the user set all parameters back to the default settings. The user has to acknowledge this menu again before the initialisation starts.

SETUP
INIT USER PARMS

Are you sure?
Press...
CLR/ACK -> YES
MENU -> NO

INIT GPS PARMS

This menu lets the user initialize all GPS datas, i.e. all saved satellite datas will be cleared. The user has to acknowledge this menu again before the initialisation starts. The system starts operating in the COLD BOOT mode and seeks for a satellite to read its actual parameters.

SETUP
INIT GPS PARMS

Are you sure?
Press...
CLR/ACK -> YES
MENU -> NO

FORCE BOOT MODE

This menu lets the user force the receiver into the Boot Mode. This may be necessary when the satellite datas in the memory are too old or the receiver position has changed by some hundred kilometers since last operation. Synchronisation time may be reduced significant. If there are valid satellite datas in the memory the system starts in the WARM BOOT mode, otherwise the system changes into COLD BOOT to read new datas.

SETUP
FORCE BOOT MODE

Are you sure?
Press...
CLR/ACK -> YES
MENU -> NO

ANTENNA CABLE

This menu asks the user to enter the length of the antenna cable. The received time frame is delayed by approx. 5ns per meter antenna cable. The receiver is able to compensate this delay if the exact cable length is given. The default value is 20m. The maximum value that can be entered is 500m (only with low loss cable).

SETUP
ANTENNA CABLE

ANTENNA CABLE
LENGTH: 020 m

Resetting Factory Defaults

If both the NEXT key and the INC key on the front panel are pressed while the system is powered up the battery buffered memory is cleared and user definable parameters are reset to factory defaults. The key should be held until the root menu is displayed on LCD. Due to the fact that the satellites' parameters have been cleared, the system comes up in COLD BOOT mode.

Firmware Updates

Whenever the on-board software must be upgraded or modified, the new firmware can be downloaded to the internal flash memory via the serial port COM0. There is no need to open the metal case and insert a new EPROM.

If the MENU key on the front panel is pressed while the system is powered up, a bootstrap-loader is activated and waits for instructions from the serial port COM0. The new firmware can be sent to GPS167 from any standard PC with serial interface. A loader program will be shipped together with the file containing the image of the new firmware.

The contents of the program memory will not be modified until the loader program has sent the command to erase the flash memory. So if the MENU key is pressed unintentionally while the system is powered up, the firmware will not be changed accidentally. After the next power-up, the system will be ready to operate again.

Skilled/Service-Personnel only: Replacing the Lithium Battery

The life time of the lithium battery on the board is at least 10 years. If the need arises to replace the battery, the following should be noted:

ATTENTION!

Danger of explosion in case of inadequate replacement of the lithium battery. Only identical batteries or batteries recommended by the manufacturer must be used for replacement. The waste battery must be disposed as proposed by the manufacturer of the battery.

CE Label



This device conforms to the directive 89/336/EWG on the approximation of the laws of the Member States of the European Community relating to electromagnetic compatibility.

Technical Specifications GPS167

RECEIVER:	6 channel C/A code receiver with external antenna/converter unit
ANTENNA:	Antenna/converter unit with remote power supply refer to chapter "Technical Specifications GPS167 Antenna"
ANTENNA INPUT:	antenna circuit DC-insulated; dielectric strength: 1000V _{DC} Length of cable: refer to chapter "Mounting the Antenna"
LC DISPLAY:	4x16 character, menu selectable by push buttons
TIME TO SYNCHRONIZATION:	one minute with known receiver position and valid almanac 12 minutes if invalid battery buffered memory
PULSE OUTPUTS:	change of second (P_SEC, TTL level) change of minute (P_MIN, TTL level)
ACCURACY OF PULSES:	after synchronization and 20 minutes of operation TCXO HQ/OCXO LQ : better als ± 250 nsec OCXO MQ/OCXO HQ : better als ± 100 nsec better than ± 2 μ sec during the first 20 minutes of operation
FREQUENCY OUTPUTS:	10 MHz, 1 MHz, 100 kHz (TTL level)

SYNTHESIZER: 1/8 Hz up to 10 MHz

ACCURACY OF
SYNTHESIZER: base accuracy depends on system accuracy

1/8 Hz to 10 kHz Phase synchron with pulse output P_SEC
10 kHz to 10 MHz frequency deviation < 0.0047 Hz

SYNTHESIZER
OUTPUTS:

F_SYNTH: TTL level

F_SYNTH_OD: open drain
drain voltage: < 100 V
sink current to GND: < 100 mA
dissipation power at 25°C: < 360 mW

F_SYNTH_SIN sine-wave
output voltage: 1.5 V eff.
output impedance: 200 Ohm

TIME_SYN
OUTPUT: TTL HIGH level if synchronized

SERIAL PORTS: max. 4 asynchronous serial ports (RS-232)

Baud Rate: 300 up to 19200
Framing: 7N2, 7E1, 7E2, 8N1, 8N2, 8E1

default setting: COM0: 19200, 8N1
COM1: 9600, 8N1
COM2: 9600, 8N1
COM3: 9600, 8N1

Annotation: Even if one of the setup functions "INIT USER
PARMS" or "Resetting Factory Defaults" is
executed, the serial port parameters are reset
to default values only if invalid parameters
have been configured.

TIME CAPTURE
INPUTS:

triggered on falling TTL slope
Interval of events: 1.5msec min.
Resolution: 100ns

POWER

REQUIREMENTS: 5V ± 5%, max. @1100mA (see oscillator specifications)

PHYSICAL

DIMENSION: 19" module in a closed 112mm high x 102mm wide closed aluminium case

FRONT PANEL: 3U / 21HP (128mm high x 107mm wide), Aluminium

REAR EDGE

CONNECTOR: according to DIN 41612, type C 64, rows a+c (male)

RF CONNECTOR: coaxial BNC

AMBIENT

TEMPERATURE: 0 ... 50°C

HUMIDITY: 85% max.

Oscillator specifications

	TCXO	OCXO LQ	OCXO MQ	OCXO HQ
short term stability $\tau = 1 \text{ sec}$	2 * 10 E-9	1 * 10 E-9	2 * 10 E-10	1 * 10 E-11
accuracy free run one day	+/- 1 * 10 E-7 +/- 1 Hz (Note 1)	+/- 2 * 10 E-8 +/- 0.2 Hz (Note 1)	+/- 1,5 * 10 E-9 +/- 15 mHz (Note 1)	+/- 5 * 10 E-10 +/- 5 mHz (Note 1)
accuracy free run one year	+/- 1 * 10 E-6 +/- 10 Hz (Note 1)	+/- 4 * 10 E-7 +/- 4 Hz (Note 1)	+/- 1 * 10 E-7 +/- 1 Hz (Note 1)	+/- 5 * 10 E-8 +/- 0.5 Hz (Note 1)
accuracy GPS-synchronous averaged 24 h	+/- 1 * 10 E-11	+/- 1 * 10 E-11	+/- 5 * 10 E-12	+/- 1 * 10 E-12
phase noise	1 Hz -60 dBc/Hz 10 Hz -90 dBc/Hz 100 Hz -120 dBc/Hz 1 kHz -130 dBc/Hz	1 Hz -60 dBc/Hz 10 Hz -90 dBc/Hz 100 Hz -120 dBc/Hz 1 kHz -130 dBc/Hz	1 Hz -75 dBc/Hz 10 Hz -110 dBc/Hz 100 Hz -130 dBc/Hz 1 kHz -140 dBc/Hz	1 Hz -95 dBc/Hz 10 Hz -125 dBc/Hz 100 Hz -145 dBc/Hz 1 kHz -155 dBc/Hz
power supply at 25°C steady state warm up	+5V / 20 mA N/A	+5V / 160 mA +5V / 380 mA	+5V / 90 mA +5V / 330 mA	+5V / 160 mA +5V / 600 mA
temperature dependant drift free run	+/- 1 * 10 E-6 (-20...70°C)	+/- 2 * 10 E-7 (0...60°C)	+/- 5 * 10 E-8 (-20...70°C)	+/- 1 * 10 E-8 (5...70°C)

Note 1:

The accuracy in Hertz is based on the standard frequency of 10 MHz. For example:
Accuracy of TCXO (free run one day) is +/- 1 * 10 E-7 * 10 MHz = +/- 1 Hz

Technical Specifications GPS167 Antenna

ANTENNA: dielectrical patch antenna, 25 x 25mm
receive frequency: 1575.42 MHz
bandwidth: 9 MHz

CONVERTER: local oscillator to converter frequency: 10 MHz
first IF frequency: 35.4 MHz

POWER

REQUIREMENTS: 12V ... 18V, @ 100mA (provided via antenna cable)

CONNECTOR: coax type N, female

AMBIENT

TEMPERATURE: -40 ... +65°C

HOUSING: ABS plastic case for outdoor installation (IP56)

PHYSICAL

DIMENSION:

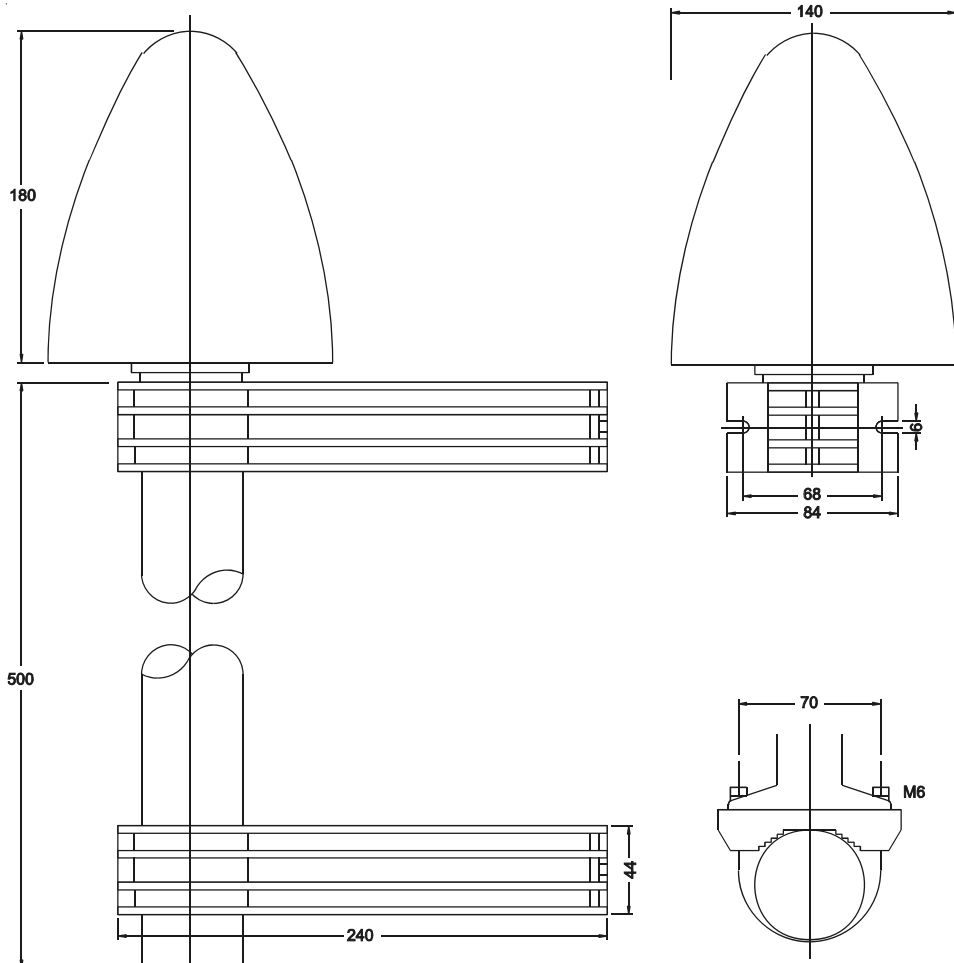

Time Strings

Format of the Meinberg Standard Time String

The Meinberg Standard Time String is a sequence of 32 ASCII characters starting with the STX (start-of-text) character and ending with the ETX (end-of-text) character. The format is:

<STX>D:dd.mm.yy;T:w;U:hh.mm.ss;uvxy<ETX>

The letters printed in *italics* are replaced by ASCII numbers whereas the other characters are part of the time string. The groups of characters as defined below:

<STX>	Start-Of-Text, ASCII Code 02h sending with one bit accuracy at change of second
dd.mm.yy	the current date: <i>dd</i> day of month (01..31) <i>mm</i> month (01..12) <i>yy</i> year of the century (00..99)
w	the day of the week (1..7, 1 = Monday)
hh.mm.ss	the current time: <i>hh</i> hours (00..23) <i>mm</i> minutes (00..59) <i>ss</i> seconds (00..59, or 60 while leap second)
uv	clock status characters (depending on clock type): <i>u</i> : ‘#’ GPS: clock is running free (without exact synchr.) PZF: time frame not synchronized DCF77: clock has not synchronized after reset ‘ ‘ (space, 20h) GPS: clock is synchronous (base accuracy is reached) PZF: time frame is synchronized DCF77: clock has synchronized after reset <i>v</i> : ‘*’ GPS: receiver has not checked its position PZF/DCF77: clock currently runs on XTAL ‘ ‘ (space, 20h) GPS: receiver has determined its position PZF/DCF77: clock is synchronized with transmitter
x	time zone indicator: ‘U’ UTC Universal Time Coordinated, formerly GMT ‘ ‘ MEZ European Standard Time, daylight saving disabled ‘S’ MESZ European Summertime, daylight saving enabled
y	announcement of discontinuity of time, enabled during last hour before discontinuity comes in effect: ‘!’ announcement of start or end of daylight saving time ‘A’ announcement of leap second insertion ‘ ‘ (space, 20h) nothing announced
<ETX>	End-Of-Text, ASCII Code 03h

Format of the Meinberg Capture String

The Meinberg Capture String is a sequence of 31 ASCII characters terminated by a CR/LF (Carriage Return/Line Feed) combination. The format is:

CH*x_tt.mm.jj_hh:mm:ss.fffffff*<CR><LF>

The letters printed in *italics* are replaced by ASCII numbers whereas the other characters are part of the time string. The groups of characters as defined below:

x 0 or 1 corresponding on the number of the capture input
– ASCII space 20h

dd.mm.yy the capture date:

dd day of month (01..31)

mm month (01..12)

yy year of the century (00..99)

hh:mm:ss.fffffff the capture time:

hh hours (00..23)

mm minutes (00..59)

ss seconds (00..59, or 60 while leap second)

fffffff fractions of second, 7 digits

<CR> Carriage Return, ASCII Code 0Dh

<LF> Line Feed, ASCII Code 0Ah

Format of the SAT Time String

The SAT Time String is a sequence of 29 ASCII characters starting with the STX (start-of-text) character and ending with the ETX (end-of-text) character. The format is:

<STX>*dd.mm.yy/w/hh:mm:ssxxxuv*<ETX>

The letters printed in *italics* are replaced by ASCII numbers whereas the other characters are part of the time string. The groups of characters as defined below:

<STX>	Start-Of-Text, ASCII Code 02h sending with one bit accuracy at change of second
<i>dd.mm.yy</i>	the current date: <i>dd</i> day of month (01..31) <i>mm</i> month (01..12) <i>yy</i> year of the century (00..99)
<i>w</i>	the day of the week (1..7, 1 = Monday)
<i>hh:mm:ss</i>	the current time: <i>hh</i> hours (00..23) <i>mm</i> minutes (00..59) <i>ss</i> seconds (00..59, or 60 while leap second)
<i>xxxx</i>	time zone indicator: 'UTC' Universal Time Coordinated, formerly GMT 'MEZ' European Standard Time, daylight saving disabled 'MESZ' European Summertime, daylight saving enabled
<i>u</i>	clock status characters: '#' clock has not synchronized after reset ' ' (space, 20h) clock has synchronized after reset
<i>v</i>	announcement of discontinuity of time, enabled during last hour before discontinuity comes in effect: '!' announcement of start or end of daylight saving time ' ' (space, 20h) nothing announced
<CR>	Carriage Return, ASCII Code 0Dh
<LF>	Line Feed, ASCII Code 0Ah
<ETX>	End-Of-Text, ASCII Code 03h

Format of the Uni Erlangen String (NTP)

The time string Uni Erlangen (NTP) of a **GPS clock** is a sequence of 66 ASCII characters starting with the STX (start-of-text) character and ending with the ETX (end-of-text) character. The format is:

<STX>tt.mm.jj; w; hh:mm:ss; voo:oo; acdfg i;bbb.bbbbn ll.llll hhhhm<ETX>

The letters printed in *italics* are replaced by ASCII numbers whereas the other characters are part of the time string. The groups of characters as defined below:

<i><STX></i>	Start-Of-Text, ASCII Code 02h sending with one bit accuracy at change of second
<i>dd.mm.yy</i>	the current date: <i>dd</i> day of month (01..31) <i>mm</i> month (01..12) <i>yy</i> year of the century (00..99)
<i>w</i>	the day of the week (1..7, 1 = Monday)
<i>hh.mm.ss</i>	the current time: <i>hh</i> hours (00..23) <i>mm</i> minutes (00..59) <i>ss</i> seconds (00..59, or 60 while leap second)
<i>v</i>	sign of the offset of local timezone related to UTC
<i>oo:oo</i>	offset of local timezone related to UTC in hours and minutes
<i>ac</i>	clock status characters: <i>a:</i> ‘#’ clock has not synchronized after reset ‘ ‘ (space, 20h) clock has synchronized after reset <i>c:</i> ‘*’ GPS receiver has not checked its position ‘ ‘ (space, 20h) GPS receiver has determined its position
<i>d</i>	time zone indicator: ‘S’ MESZ European Summertime, daylight saving enabled ‘ ‘ MEZ European Standard Time, daylight saving disabled
<i>f</i>	announcement of discontinuity of time, enabled during last hour before discontinuity comes in effect: ‘!’ announcement of start or end of daylight saving time ‘ ‘ (space, 20h) nothing announced
<i>g</i>	announcement of discontinuity of time, enabled during last hour before discontinuity comes in effect: ‘A’ announcement of leap second insertion ‘ ‘ (space, 20h) nothing announced

i leap second insertion
 'L' leap second is actually inserted
 (active only in 60th sec.)
 ' ' (space, 20h) no leap second is inserted

bbb.bbbb latitude of receiver position in degrees
 leading signs are replaced by a space character (20h)

n latitude, the following characters are possible:
 'N' north of equator
 'S' south d. equator

lll.llll longitude of receiver position in degrees
 leading signs are replaced by a space character (20h)

e longitude, the following characters are possible:
 'E' east of Greenwich
 'W' west of Greenwich

hhhh altitude above sea level in meters
 leading signs are replaced by a space character (20h)

<ETX> End-Of-Text, ASCII Code 03h

Format of the NMEA 0183 String (RMC)

The NMEA String is a sequence of 65 ASCII characters starting with the '\$' character and ending with the characters CR (carriage return) and LF (line-feed). The format is:

\$GPRMC,*hhmmss.ss,A,bbbb.bb,n,llll.ll,e,0.0,0.0,ddmmyy,0.0,a*hh*<CR><LF>

The letters printed in *italics* are replaced by ASCII numbers or letters whereas the other characters are part of the time string. The groups of characters as defined below:

\$	Start character, ASCII Code 24h sending with one bit accuracy at change of second
<i>hhmmss.ss</i>	the current time: <i>hh</i> hours (00..23) <i>mm</i> minutes (00..59) <i>ss</i> seconds (00..59, or 60 while leap second) <i>ss</i> fractions of seconds (1/10 ; 1/100)
A	Status (A = time data valid) (V = time data not valid)
<i>bbbb.bb</i>	latitude of receiver position in degrees leading signs are replaced by a space character (20h)
<i>n</i>	latitude, the following characters are possible: 'N' north of equator 'S' south d. equator
<i>llll.ll</i>	longitude of receiver position in degrees leading signs are replaced by a space character (20h)
<i>e</i>	longitude, the following characters are possible: 'E' east of Greenwich 'W' west of Greenwich
<i>ddmmyy</i>	the current date: <i>dd</i> day of month (01..31) <i>mm</i> month (01..12) <i>yy</i> year of the century (00..99)
<i>a</i>	magnetic variation
<i>hh</i>	checksum (EXOR over all characters except '\$' and '*')
<CR>	Carriage Return, ASCII Code 0Dh
<LF>	Line Feed, ASCII Code 0Ah

Format of the ABB SPA Time String

The ABB SPA Time String is a sequence of 32 ASCII characters starting with the characters ">900WD" and ending with the <CR> (Carriage Return) character. The format is:

>900WD;*yy-mm-tt_hh.mm;ss.fff:cc*<CR>

The letters printed in *italics* are replaced by ASCII numbers whereas the other characters are part of the time string. The groups of characters as defined below:

<i>yy-mm-tt</i>	the current date:	
<i>yy</i>	year of the century	(00..99)
<i>mm</i>	month	(01..12)
<i>dd</i>	day of month	(01..31)
–	Space (ASCII code 20h)	
<i>hh.mm;ss.fff</i>	the current time:	
<i>hh</i>	hours	(00..23)
<i>mm</i>	minutes	(00..59)
<i>ss</i>	seconds	(00..59, or 60 while leap second)
<i>fff</i>	milliseconds	(000..999)
<i>cc</i>	Check sum. EXCLUSIVE-OR result of the previous characters, displayed as a HEX byte (2 ASCII characters 0..9 or A..F)	
<CR>	Carriage Return, ASCII Code 0Dh	

Format of the Computime Time String

The Computime time string is a sequence of 24 ASCII characters starting with the T character and ending with the LF (line feed, ASCII Code 0Ah) character. The format is:

T:*yy:mm:dd:ww:hh:mm:ss*<CR><LF>

The letters printed in *italics* are replaced by ASCII numbers whereas the other characters are part of the time string. The groups of characters as defined below:

T	Start character sending with one bit accuracy at change of second
<i>yy:mm:dd</i>	the current date: <i>yy</i> year of the century (00..99) <i>mm</i> month (01..12) <i>dd</i> day of month (01..31)
<i>ww</i>	the day of the week (01..07, 01 = monday)
<i>hh:mm:ss</i>	the current time: <i>hh</i> hours (00..23) <i>mm</i> minutes (00..59) <i>ss</i> seconds (00..59, or 60 while leap second)
<CR>	Carriage Return, ASCII Code 0Dh
<LF>	Line Feed, ASCII Code 0Ah

Timecode (optional)

Principle of Operation

The Board GPS167 has been designed for the generation of IRIG, AFNOR and IEEE1344 standard time codes. Apart from the digitally generated amplitude-modulated code, it also provides the unmodulated DC-Level shift code. The modulated sine wave carrier and the board's internal time pattern are derived from the radio clock's disciplined oscillator.

Block Diagram Timecode

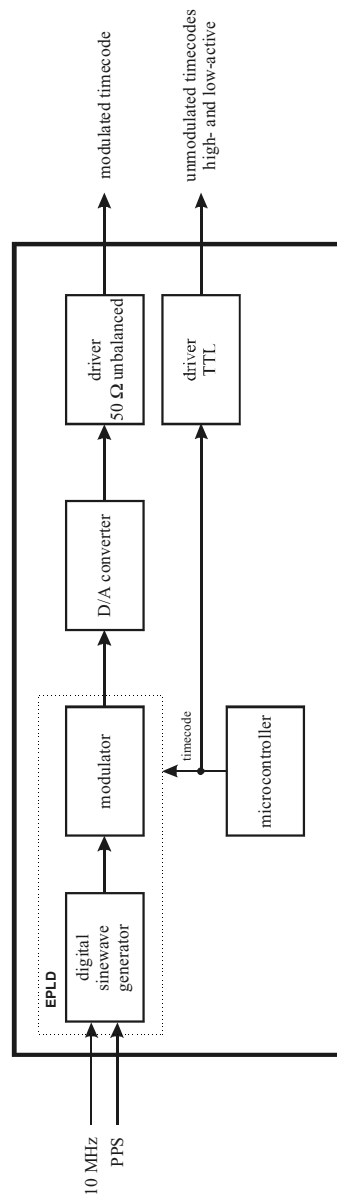

IRIG Standard Format

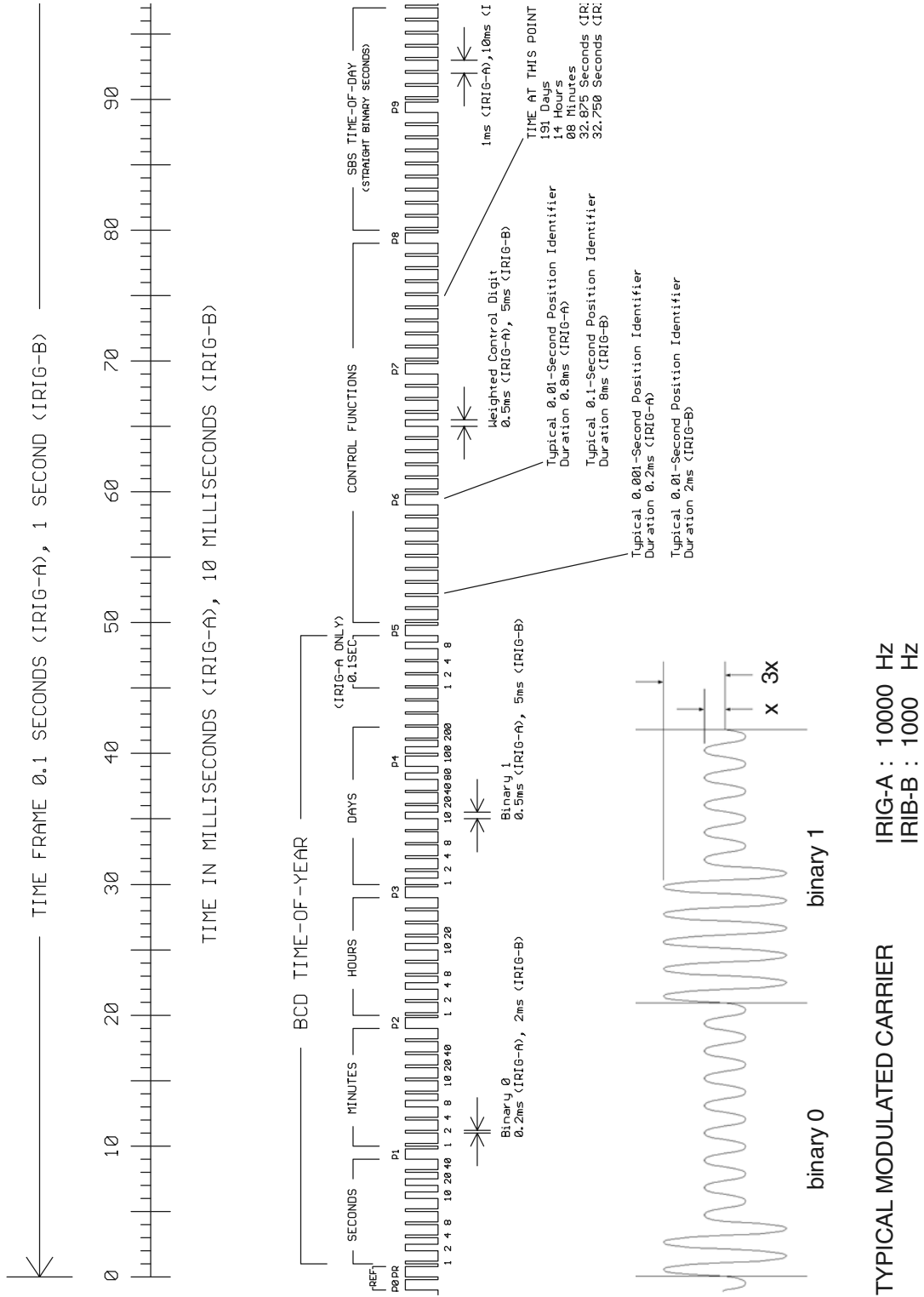

AFNOR Standard Format

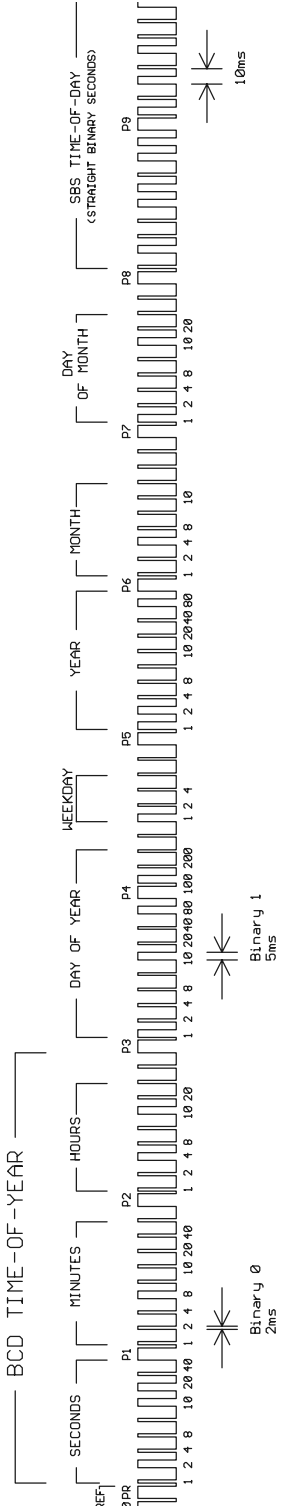
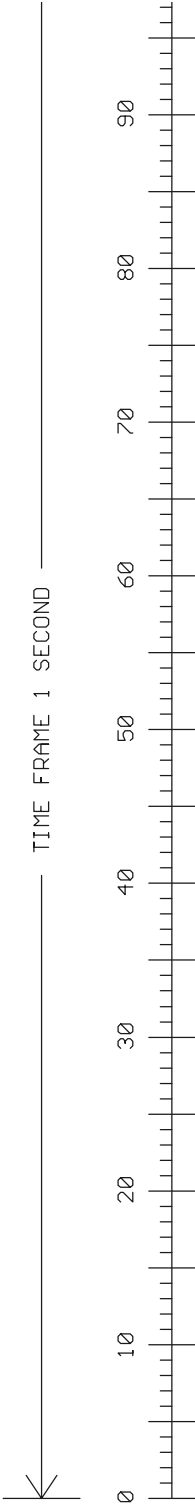

Assignment of CF Segment in IEEE1344 mode

Bit No.	Designation	Description
49	Position Identifier P5	
50	Year BCD encoded 1	low nibble of BCD encoded year
51	Year BCD encoded 2	
52	Year BCD encoded 4	
53	Year BCD encoded 8	
54	empty, always zero	
55	Year BCD encoded 10	high nibble of BCD encoded year
56	Year BCD encoded 20	
57	Year BCD encoded 40	
58	Year BCD encoded 80	
59	Position Identifier P6	
60	LSP - Leap Second Pending	set up to 59s before LS insertion
61	LS - Leap Second	0 = add leap second, 1 = delete leap second ^{1.)}
62	DSP - Daylight Saving Pending	set up to 59s before daylight saving changeover
63	DST - Daylight Saving Time	set during daylight saving time
64	Timezone Offset Sign	sign of TZ offset 0 = '+', 1 = '-'
65	TZ Offset binary encoded 1	Offset from IRIG time to UTC time. Encoded IRIG time plus TZ Offset equals UTC at all times !
66	TZ Offset binary encoded 2	
67	TZ Offset binary encoded 4	
68	TZ Offset binary encoded 8	
69	Position Identifier P7	
70	TZ Offset 0.5 hour	set if additional half hour offset
71	TFOM Time figure of merit	time figure of merit represents approximated clock error. ^{2.)} 0x00 = clock locked 0x0F = clock failed
72	TFOM Time figure of merit	
73	TFOM Time figure of merit	
74	TFOM Time figure of merit	
75	PARITY	parity on all preceding bits incl. IRIG-B time
^{1.)} current firmware does not support deletion of leap seconds		
^{2.)} TFOM is cleared, when clock is synchronized first after power up. <i>see chapter Selection of generated timecode</i>		

Generated Timecodes

Besides the amplitude modulated sine wave signal, the board also provides unmodulated DC-Level Shift TTL output in parallel. Thus six time codes are available.

- a) B002: 100pps, PWM DC signal, no carrier
BCD time of year
- b) B122: 100pps, AM sine wave signal, 1 kHz carrier frequency
BCD time of year
- c) B003: 100pps, PWM DC signal, no carrier
BCD time of year, SBS time of day
- d) B123: 100pps, AM sine wave signal, 1 kHz carrier frequency
BCD time of year, SBS time of day
- e) AFNOR: Code according to NFS-87500, 100pps,
AM sine wave signal, 1kHz carrier frequency,
BCD time of year, complete date, SBS time-of-day,
Signal level according to NFS-87500
- f) IEEE1344: Code according to IEEE1344-1995, 100pps,
AM sine wave signal, 1kHz carrier frequency,
BCD time-of-year, SBS time of day, IEEE1344
extensions for date, timezone, daylight-saving
and leap second in control functions (CF) segment.
see also table 'Assignment of CF segment in IEEE1344 mode'

Selection of Generated Time Code

The time code to be generated can be selected by Menu Setup IRIG Settings or the GPS Monitorprogram. DC-Level Shift Codes (PWM signal) B00x and modulated sine wave carrier B12x are always generated simultaneously. Both signals are provided at the VG64-Connector, i.e. if code B132 is selected also code B002 is available. This applies for the codes AFNOR NFS 87-500 and IEEE1344 as well.

The TFOM field in IEEE1344 code is set dependent on the 'already sync'ed' character ('#') which is sent in the serial time telegram. This character is set, whenever the preconnected clock was not able to synchronize after power up reset. The 'time figure of merit' (TFOM) field is set as follows.

Clock synchronized once after power up	:	TFOM = 0000
Clock <u>not</u> synchronized after power up	:	TFOM = 1111

For testing purposes the output of TFOM in IEEE1344 mode can be disabled. The segment is then set to all zeros.

Outputs

The module GPS167-TC provides modulated and unmodulated (DC-Level Shift) outputs. The format of the timecodes is illustrated "IRIG-" and "AFNOR standardformat".

AM Sine Wave Output

The amplitude-modulated carrier is available at the VG connector pin 14a. The carrier frequency depends on the code and has a value of 1 kHz (IRIG-B). The signal amplitude is $3V_{pp}$ (MARK) and $1V_{pp}$ (SPACE) into 50Ω . The encoding is made by the number of MARK amplitudes during ten carrier waves. The following agreements are valid:

- | | | |
|------------------------|---|---------------------------------------|
| a) binary "0" | : | 2 MARK amplitudes, 8 SPACE amplitudes |
| b) binary "1" | : | 5 MARK amplitudes, 5 SPACE amplitudes |
| c) position-identifier | : | 8 MARK amplitudes, 2 SPACE amplitudes |

PWM DC Outputs

The pulse width modulated DC signals labeled "IRIG" and "AFNOR standard format" are coexistent to the modulated output and is available at the VG connector pin 13a with TTL level.

Technical Data

Outputs: Unbalanced AM sine wave signal:
 $3V_{PP}$ (MARK) / $1V_{PP}$ (SPACE) into 50Ω

PWM signal: TTL, high and low active

Signal Description GPS167 V7.x

Name	Pin	Function
GND	32a+c	Ground
VCC in (+5V)	1a+c	+5V supply
VCC in (+12V)	2a+c	+12V supply
VCC in (+5V)	3a+c	+5 V supply (TCXO / OCXO)
P_SEC out	6c	Pulse when second changes, TTL level, active high, length 200 msec
P_MIN out	8c	Pulse when minute changes, TTL level, active high, length 200 msec
/RESET_out	9c	RESET signal, Push/Pull up to +5V
Prog. Pulse out	10c-12c	programmable pulse, TTLlevel
100 kHz out	10a	100 kHz frequency output, TTL level
1 MHz out	11a	1 MHz frequency output, TTL level
10 MHz out	12a	10 MHz frequency output, TTL level
TIMECODE DC	13a	Timecode unmod. out
TIMECODE AM	14a	Timecode mod. out 3Vpp
DCF_MARK out	17c	DCF77 compatible second marks, TTL level active high, length 100/200 msec
TIME_SYN	19c	TTL output, HIGH level if synchronization has been achieved, LOW level after reset or in case of serious errors (e.g. antenna faulty)
F_SYNTH	21c	Synthesizer output, TTL-Pegel
F_SYNTH_OD	22c	Synthesizer output, Open Drain, max sink current to GND: 150mA
F_SYNTH_SIN	23c	Synthesizer output, sine-wave 1.5 V eff.
CAPx	27c, 28c	Time capture inputs (TTL), capture on falling slope
COMx TxD out		COMx RS-232 transmit data output
COMx RxD in		COMx RS-232 receive data input
SDA, SCL, SCL_EN (reserved)		internal serial control bus, for extension boards reserved, do not connect

Rear Connector Pin Assignments GPS167 V7.x

	a	c
1	VCC in (+5V)	VCC in (+5V)
2	VCC in (+12V)	VCC in (+12V)
3	VDD in (TCXO/OCXO)	VDD in (TCXO/OCXO)
4	(reserved, FreqAdjust out)	
5		
6		P_SEC out
7		
8	(reserved, 10 MHz in)	P_MIN out
9		/RESET out
10	100 kHz out	ProgPulse0 out
11	1 MHz out	ProgPulse1 out
12	10 MHz out	ProgPulse2 out
13	TIME CODE DC out	SCL
14	TIME CODE AM out	SCL_EN
15	COM2 RxD in	SDA
16	COM2 TxD out	(reserved, P3.2)
17	COM3 RxD in	DCF_MARK out
18	COM3 TxD out	(reserved, Vref/TxD2 TTL)
19	GND	TIME_SYN out
20	GND	(reserved, P2.3)
21	GND	F_SYNTH out
22	GND	F_SYNTH_OD out
23	GND	F_SYNTH_SIN out
24	GND	COM1 TxD out
25	GND	
26	GND	COM0 TxD out
27	GND	CAP1 in
28	GND	CAP0 in
29	GND	COM1 RxD in
30	GND	COM0 RxD in
31	GND	GND
32	GND	GND

male connector according to DIN 41612, type C 64, rows a + c

Menu Quick Reference

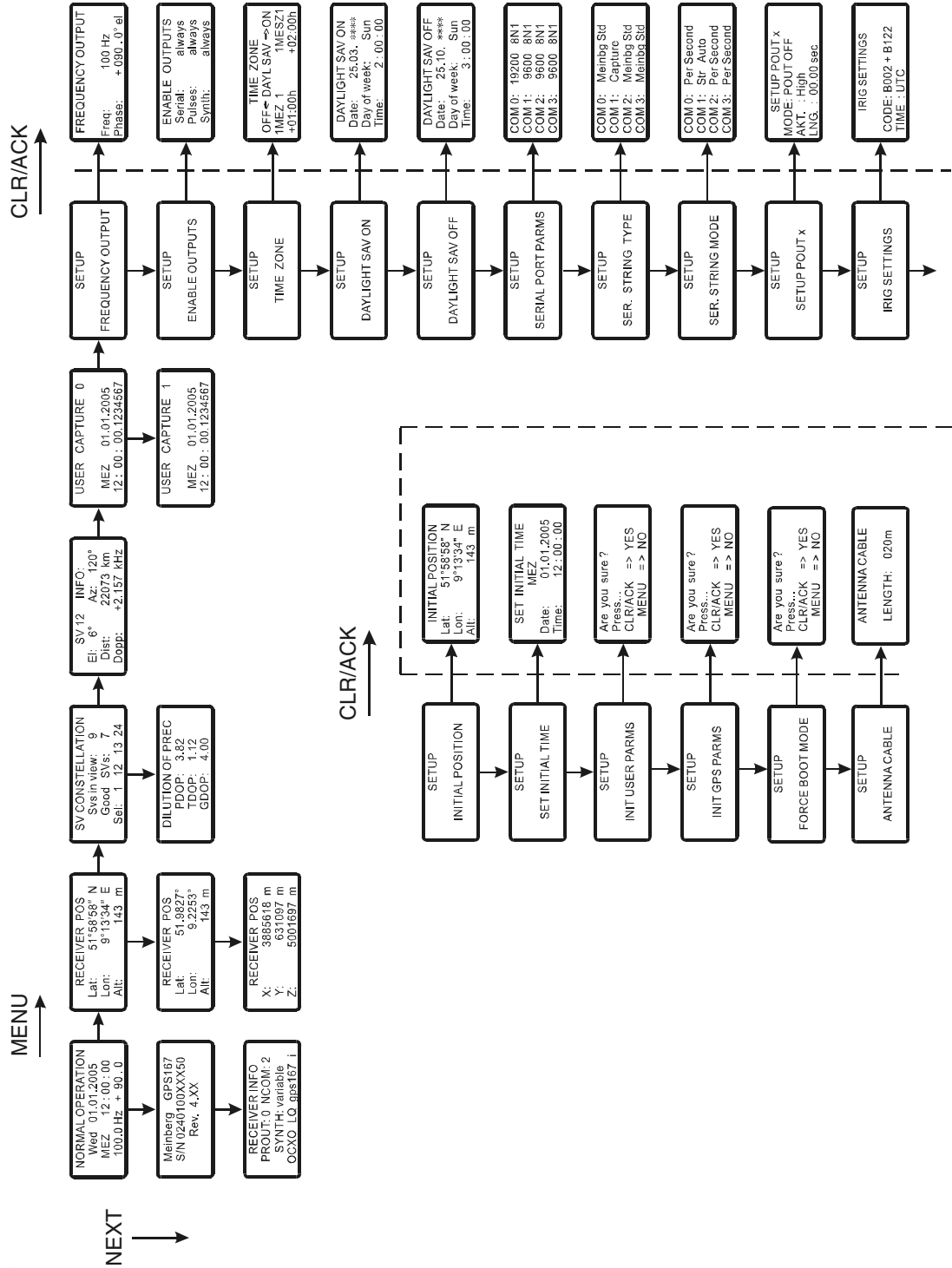



GPS167-E-250406