

# CASIO®

Digital Camera

# EX-S10

## User's Guide

E

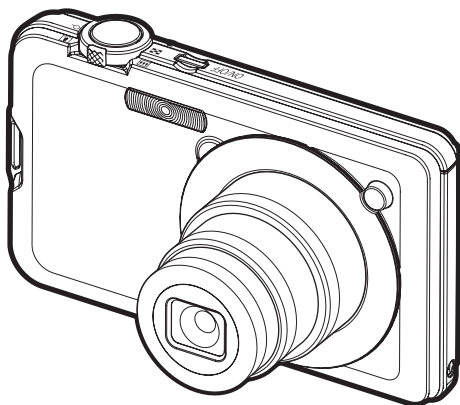

K1100PCM1DMX

Thank you for purchasing this CASIO product.

- Before using it, be sure to read the precautions contained in this User's Guide.
- Keep the User's Guide in a safe place for future reference.
- For the most up-to-date information about this product, visit the official EXILIM Website at <http://www.exilim.com/>

# EXILIM

## Unpacking

As you unpack your camera, check to make sure that all items shown below are included. If anything is missing, contact your original retailer.

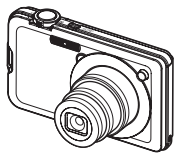

Digital camera

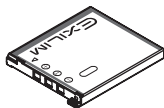

Rechargeable lithium ion battery (NP-60)

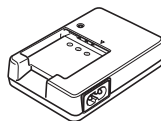

Charger unit (BC-60L)

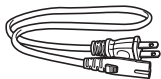

Power cord



Strap

To attach the strap to the camera

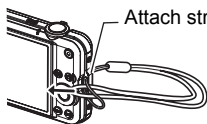

Attach strap here.



USB cable

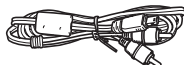

AV cable



CD-ROM

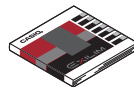

Basic Reference

## Read this first!

- The contents of this manual are subject to change without notice.
- The contents of this manual have been checked at each step of the production process. Feel free to contact us if you notice anything that is questionable, erroneous, etc.
- Any copying of the contents of this User's Guide, either in part or its entirety, is forbidden. Except for your own personal use, any other use of the contents of this manual without the permission of CASIO COMPUTER CO., LTD. is forbidden under copyright laws.
- CASIO COMPUTER CO., LTD. shall not be held liable for any damages or lost profits suffered by you or any third party due to the use or malfunction of this product.
- CASIO COMPUTER CO., LTD. shall not be held liable for any damages, lost profits, or claims by third parties arising out of the use of Photo Loader with HOT ALBUM, Photo Transport, YouTube Uploader for CASIO, or CASIO DATA TRANSPORT.
- CASIO COMPUTER CO., LTD. shall not be held liable for any damages or lost profits caused by loss of memory contents due to malfunction, repair, or any other reason.
- Note that the example screens and product illustrations shown in this User's Guide may differ somewhat from the screens and configuration of the actual camera.

### LCD Panel

The liquid crystal panel of the monitor screen uses high-precision technology that provides a pixel yield in excess of 99.99%. This means that some very small number of pixels may not light or may remain lit at all times. This is due to the characteristics of the liquid crystal panel, and does not indicate malfunction.

#### **Take a few test shots**

Before shooting your final image, shoot a test shot to ensure that the camera is recording correctly.

# Contents

Unpacking .....	2
Read this first! .....	3

## ■ Quick Start Basics 9

---

What is a digital camera? .....	9
What you can do with your CASIO camera .....	10
First, charge the battery prior to use.....	11
■ To charge the battery .....	11
■ To load the battery .....	12
Configuring the Display Language the First Time You Turn On the Camera. .	13
Preparing a Memory Card .....	14
■ Supported Memory Cards .....	14
■ To load a memory card .....	14
■ To format (initialize) a new memory card .....	15
To shoot a snapshot. ....	16
Holding the Camera Correctly .....	18
Viewing Snapshots .....	19
Deleting Images .....	20
■ To delete a single file .....	20
■ To delete all files .....	20
Snapshot Shooting Precautions .....	21
■ Auto Focus Restrictions .....	21
Turning the Camera On and Off .....	22
■ To turn power on .....	22
■ To turn off the camera .....	22

## ■ Snapshot Tutorial 23

---

Using the Control Panel .....	23
Changing the Image Size .....	(Size) .. 24
Using Flash .....	(Flash) .. 26
Using Auto Shutter .....	(Auto Shutter) .. 28
■ To use Detect Blur to minimize image blur .....	(Detect Blur) .. 28
■ To use Detect Panning to minimize image blur .....	(Detect Panning) .. 29
■ To use Detect Smile to record when a subject is smiling .....	(Detect Smile) .. 29
■ To change Auto Shutter trigger sensitivity .....	(Sensitivity) .. 30
Using Face Recognition .....	(Face Recognition) .. 32
■ To perform a face recognition recording operation .....	(Normal) .. 32
■ Using the Family First Mode .....	(Family First) .. 33
Using Continuous Shutter .....	(Continuous) .. 38
Specifying ISO Sensitivity .....	(ISO) .. 40
Correcting Image Brightness .....	(EV Shift) .. 41
Changing the Control Panel Date/Time Style .....	42
Shooting with Zoom .....	42
■ Optical Zoom and Digital Zoom Switch Point .....	43

## ■ Recording Movie Images and Audio 45

---

To record a movie .....	45
Using Prerecord Movie .....	47
Shooting a Snapshot while Shooting a Movie .....	48
Recording Audio Only .....	(Voice Recording) .. 48
■ To play back an audio recording .....	49

## ■ Using BEST SHOT 50

---

What is BEST SHOT? .....	50
■ Some Sample Scenes .....	50
To shoot an image with BEST SHOT .....	50
■ Creating Your Own BEST SHOT Setups .....	52
Shooting Images of Business Cards and Documents .....	53
Recording a Self-portrait .....	55

## ■ Advanced Settings 56

---

Using On-screen Menus .....	56
REC Mode Settings .....	(REC) .. 58
■ Selecting a Focus Mode .....	(Focus) .. 58
■ Using Continuous Shutter .....	(Continuous) .. 61
■ Using the Self-timer .....	(Self-timer) .. 61
■ Using Auto Shutter .....	(Auto Shutter) .. 62
■ Shooting with Face Recognition .....	(Face Recognition) .. 62
■ Reducing the Effects of Camera and Subject Movement .....	(Anti Shake) .. 62
■ Specifying the Auto Focus Area .....	(AF Area) .. 63
■ Using the Auto Focus Assist Light .....	(AF Assist Light) .. 63
■ Turning Digital Zoom On or Off .....	(Digital Zoom) .. 64
■ Assigning Functions to the [◀] and [▶] Keys .....	(L/R Key) .. 64
■ Shooting with Quick Shutter .....	(Quick Shutter) .. 64
■ Displaying the On-screen Grid .....	(Grid) .. 65
■ Turning on Image Review .....	(Review) .. 65
■ Using Icon Help .....	(Icon Help) .. 65
■ Configuring Power On Default Settings .....	(Memory) .. 66
Image Quality Settings .....	(Quality) .. 67
■ Specifying Snapshot Size .....	(Size) .. 67
■ Specifying Snapshot Image Quality .....	(Quality (Snapshot)) .. 67
■ Specifying Movie Image Quality .....	(Quality (Movie)) .. 67
■ Correcting Image Brightness .....	(EV Shift) .. 68
■ Controlling White Balance .....	(White Balance) .. 68
■ Specifying ISO Sensitivity .....	(ISO) .. 69
■ Specifying the Metering Mode .....	(Metering) .. 69
■ Reducing Overexposure and Underexposure .....	(Dynamic Range) .. 70
■ Enhancing Skin Tones in a Portrait .....	(Portrait Refiner) .. 70
■ Using Built-in Color Filters .....	(Color Filter) .. 70
■ Controlling Image Sharpness .....	(Sharpness) .. 70
■ Controlling Color Saturation .....	(Saturation) .. 70
■ Adjusting Image Contrast .....	(Contrast) .. 71

- Specifying Flash Intensity ..... (Flash Intensity)... 71
- Turning On Flash Assist ..... (Flash Assist)... 71

## ■ Viewing Snapshots and Movies 72

---

- Viewing Snapshots ..... 72
- Viewing a Movie ..... 72
- Zooming an On-screen Image ..... 73
- Displaying 12 Images on the Same Screen ..... 73
- Displaying Images in the Calendar Screen ..... 74
- Using Image Roulette ..... 74
- Viewing Snapshots and Movies on a TV Screen ..... 75

## ■ Other Playback Functions (PLAY) 77

---

- Playing a Slideshow on the Camera ..... (Slideshow) .. 77
  - Saving Music from Your Computer to Camera Memory ..... 78
- Laying Out Snapshots with Layout Print ..... (Layout Print) .. 79
- Creating a Snapshot of Movie Frames ..... (MOTION PRINT) .. 80
- Editing a Movie on the Camera ..... (Movie Editing) .. 81
- Reducing the Effects of Underexposure ..... (Dynamic Range) .. 82
- Adjusting White Balance ..... (White Balance) .. 83
- Adjusting the Brightness of an Existing Snapshot ..... (Brightness) .. 84
- Keystone Correction ..... (Keystone) .. 84
- Using Color Correction to Correct the Color of  
an Old Photograph ..... (Color Correction) .. 85
- Selecting Images for Printing ..... (DPOF Printing) .. 86
- Protecting a File Against Deletion ..... (Protect) .. 86
- Editing the Date and Time of an Image ..... (Date/Time) .. 87
- Rotating an Image ..... (Rotation) .. 87
- Resizing a Snapshot ..... (Resize) .. 88
- Cropping a Snapshot ..... (Trimming) .. 88
- Adding Audio to a Snapshot ..... (Dubbing) .. 89
  - To play snapshot audio ..... 90
- Copying Files ..... (Copy) .. 91

## ■ Printing 92

---

- Printing Snapshots ..... 92
- Connecting Directly to a PictBridge Compatible Printer ..... 93
- Using DPOF to Specify Images to be Printed and the Number of Copies. .. 95

## ■ Using the Camera with a Computer 98

---

- Things you can do using a computer... ..... 98
- Using the Camera with a Windows Computer ..... 99
  - Viewing and Storing Images on a Computer ..... 101
  - Save images to a computer automatically/Manage images ..... 104

■ Playing Movies	105
■ Uploading Movie Files to YouTube	105
■ Transferring Images from Your Computer to Camera Memory	107
■ Viewing User Documentation (PDF Files)	108
■ User Registration	109
Using the Camera with a Macintosh	110
■ Connecting the Camera to Your Computer and Saving Files	110
■ Transferring Images Automatically and Managing Them on Your Macintosh	112
■ Playing a Movie	113
■ Viewing User Documentation (PDF Files)	113
■ User Registration	113
Files and Folders	114
Memory Card Data	115

## ■ Transferring Document Data from Your Computer to the Camera 117

---

Transferring Document Data to the Camera	117
■ Transferring Data from a Computer Running Windows	117
■ Transferring Data from a Macintosh	118
To view document images on the camera	119
Managing Document Data on the Camera	121
■ Protecting Document Data	121
■ Deleting Document Data	121

## ■ Other Settings (Set Up) 123

---

Selecting a REC Mode Screen Layout (Panel)	123
Selecting a PLAY Mode Screen Layout (Display)	124
Adjusting Monitor Screen Brightness (Screen)	124
Configuring Camera Sound Settings (Sounds)	125
Configuring a Startup Image (Startup)	125
Specifying the File Name Serial Number Generation Rule (File No.)	126
Configuring World Time Settings (World Time)	127
Time Stamping Snapshots (Timestamp)	127
Setting the Camera's Clock (Adjust)	128
Specifying the Date Style (Date Style)	128
Specifying the Display Language (Language)	129
Specifying the Initial Data Mode Screen (DATA View)	129
Configuring Sleep State Settings (Sleep)	129
Configuring Auto Power Settings (Auto Power Off)	130
Configuring [REC] and [PLAY] Settings (REC/PLAY)	130
Configuring USB Protocol Settings (USB)	131
Selecting the Screen Aspect Ratio and Video Output System (Video Out)	131
Formatting Built-in Memory or a Memory Card (Format)	132
Resetting the Camera to Factory Defaults (Reset)	132

---

## ■ ■ **Configuring Monitor Screen Settings** **133**

---

Using the On-screen Histogram to Check Exposure . . . . . (+Histogram) . . . . .	133
■ How to Use the Histogram . . . . .	134

## ■ ■ **Appendix** **135**

---

Precautions during Use . . . . .	135
Power Supply . . . . .	144
■ Charging . . . . .	144
■ To replace the battery . . . . .	144
■ Battery Precautions. . . . .	144
■ Using the Camera in another Country . . . . .	145
Using a Memory Card . . . . .	146
■ To replace the memory card . . . . .	146
Computer System Requirements for Bundled Software . . . . .	147
General Guide . . . . .	149
Monitor Screen Contents . . . . .	150
Reset Initial Default Settings . . . . .	152
When things don't go right... . . . .	155
■ Troubleshooting . . . . .	155
■ Display Messages. . . . .	159
Number of Snapshots and Movie Recording Time . . . . .	161
Specifications . . . . .	163



# Quick Start Basics

## What is a digital camera?

A digital camera stores images on a memory card, so you can record and delete images a countless number of times.

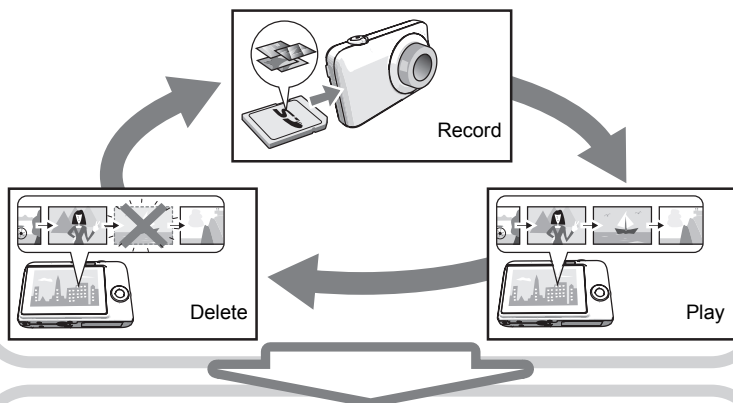

You can use the images you record in a variety of different ways.

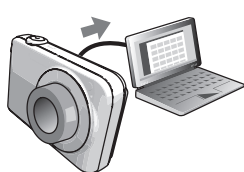

Store images on your computer.

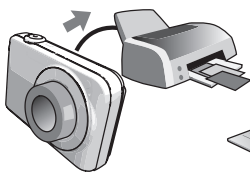

Print images.



Attach images to e-mail.

## What you can do with your CASIO camera

Your CASIO camera is packed with a powerful selection of features and functions to make recording of digital images easier, including the following three main functions.



### Auto Shutter

The camera releases the shutter automatically when it detects the camera is still, the subject is smiling, etc.

See page **28** for more information.

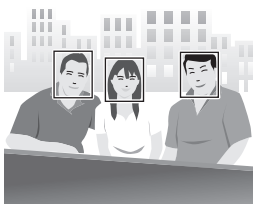

### Face Recognition

Point the camera at a person and it automatically detects the person's face for beautiful portraits every time.

See page **32** for more information.



### BEST SHOT

Simply select the sample scene you want and the camera sets up automatically. Then all you need do is press the shutter button for perfect images.

See page **50** for more information.

## First, charge the battery prior to use.

Note that the battery of a newly purchased camera is not charged. Perform the steps under “To charge the battery” to bring the battery to a full charge.

- Your camera requires a special CASIO rechargeable lithium ion battery (NP-60) for power. Never try to use any other type of battery.

### To charge the battery

- 1. Positioning the positive ⊕ and negative ⊖ terminals of the battery with those of the charger unit, load the battery into the charger unit.**

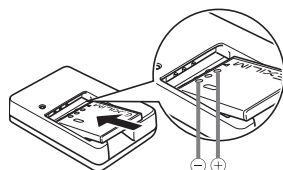

- 2. Plug the charger unit into a household power outlet.**

About 90 minutes are required to reach full charge. The [CHARGE] lamp will go out when charging is complete. Unplug the power cord from the power outlet and then remove the battery from the charger.

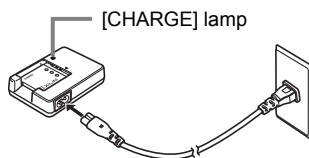

Lamp Status	Description
Lit Red	Charging
Flashing Red	Charger unit or battery problem (page 144)
Off	Charging complete or standing by, due to abnormally high or low ambient temperature (page 144)

### Other Charging Precautions

- Use the special charger (BC-60L) to charge the special lithium ion battery (NP-60). Never use any other type of charger device. Attempting to use a different charger can result in unexpected accident.
- A battery that is still warm due to normal use may not charge fully. Give the battery time to cool before charging it.
- A battery discharges slightly even when it is not loaded in the camera. Because of this, it is recommended that you charge the battery immediately before you need to use it.
- Charging the camera's battery may cause interference with TV and radio reception. If this happens, plug the charger into an outlet that is further away from the TV or radio.
- Actual charging time depends on current battery capacity and charging conditions.

## To load the battery

### 1. Open the battery cover.

Slide the battery cover slider towards OPEN and then open it as indicated by the arrows in the illustration.



### 2. Load the battery.

With the EXILIM logo on the battery facing upwards (in the direction of the monitor screen), hold the stopper next to the battery in the direction indicated by the arrow as you slide the battery into the camera. Press the battery in until the stopper secures it in place.

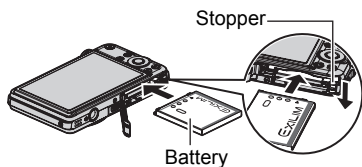



### 3. Close the battery cover.

Close the battery cover and then shift the slider towards LOCK.



## Checking Remaining Battery Power

As battery power is consumed, a battery indicator on the monitor screen indicates remaining power as shown below.

Remaining Power	High ←————→ Low
Battery Indicator	 →  →  → 
Indicator Color	Cyan → Amber → Red → Red

 indicates battery power is low. Charge the battery as soon as possible.

Recording is not possible when  is indicated. Charge the battery immediately.

- The level shown by the battery indicator may change when you switch between the REC mode and PLAY mode.
- Leaving the camera for about two days with no power supplied while the battery is dead will cause its date and time settings to be cleared. You will have to re-configure the settings after power is restored.
- See page 165 for information about battery life and memory capacity.

## Battery Power Conservation Tips

- When you do not need to use the flash, select  (flash off) for the flash setting (page 26).
- Enable the Auto Power Off and the Sleep features to protect against wasting battery power when you forget to turn off the camera (pages 129, 130).

## Configuring the Display Language the First Time You Turn On the Camera

The first time you load a battery into the camera, a screen appears for configuring the display language, date, and time settings. Failure to set the date and time correctly will cause the wrong date and time data to be recorded with images.

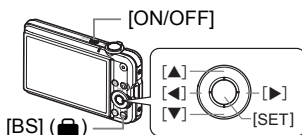

1. Press [ON/OFF] to turn on the camera.
2. Use [▲], [▼], [◀], and [▶] to select the language you want and then press [SET].

3. Use [▲], [▼], [◀], and [▶] to select the area where you will be using the camera and then press [SET].

The selected area is highlighted in red.



4. Use [▲] and [▼] to select the city where you will be using the camera and then press [SET].
5. Use [▲] and [▼] to select the summer time (DST) setting you want and then press [SET].

6. Use [▲] and [▼] to select a date style and then press [SET].

Example: 19. 12. 09  
YY/MM/DD → 09/12/19  
DD/MM/YY → 19/12/09  
MM/DD/YY → 12/19/09

7. Set the date and the time.

Use [◀] and [▶] to select the setting you want to change and then use [▲] and [▼] to change it.

To switch between 12-hour and 24-hour format, press [BS] (🔒).

8. Press [SET].

- If you make a mistake, you can change the settings later (pages 128, 129).

### NOTE

- Each country controls its local time offset and the use of summer time, and so they are subject to change.

## Preparing a Memory Card

Though the camera has built-in memory that can be used to store images and movies, you probably will want to purchase a commercially available memory card for greater capacity. The camera does not come with a memory card. Images recorded while a memory card is loaded are saved to the memory card. When no memory card is loaded, images are saved to built-in memory.

- For information about memory card capacities, see page 161.

### Supported Memory Cards

- SD Memory Card
- SDHC Memory Card
- MMC (MultiMediaCard)
- MMC*plus* (MultiMediaCard*plus*)



Use one of the above types of memory card.

### To load a memory card

#### 1. Press [ON/OFF] to turn off the camera and then open the battery cover.

Slide the battery cover slider towards OPEN and then open it as indicated by the arrows in the illustration.



#### 2. Load a memory card.

Positioning the memory card so its front is facing upwards (towards the monitor screen side of the camera), slide it into the card slot all the way in until you hear it click securely into place.

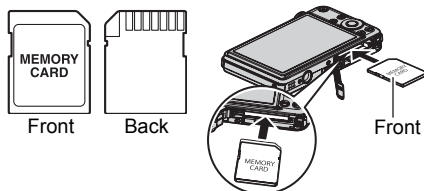

#### 3. Close the battery cover.

Close the battery cover and then shift the slider towards LOCK.



### IMPORTANT!

- Never insert anything besides a supported memory card (page 14) into the memory card slot.
- Should water or any foreign object ever get into the card slot, immediately turn off the camera, remove the battery, and contact your retailer or nearest CASIO authorized service center.

## **To format (initialize) a new memory card**

---

You need to format a new memory card before using it for the first time.

- 1. Turn on the camera and press [MENU].**

---

- 2. Select the “Set Up” tab, select “Format” and then press [▶].**

---

- 3. Use [▲] and [▼] to select “Format” and then press [SET].**



### **IMPORTANT!**

- Formatting a memory card that already has snapshots or other files on it, will delete its contents. Normally you do not need to format a memory card again. However, if storing to a card has slowed down or if you notice any other abnormality, re-format the card.
- Be sure to use the camera to format a memory card. Formatting a memory card on a computer and then using it in the camera can slow down data processing by the camera. In the case of an SD or SDHC memory card, formatting on a computer can result in non-conformity with the SD format, causing problems with compatibility, operation, etc.

## To shoot a snapshot

### 1. Press [📷] (REC) to turn on the camera.

Make sure  is on the display. If it isn't, see page 50.

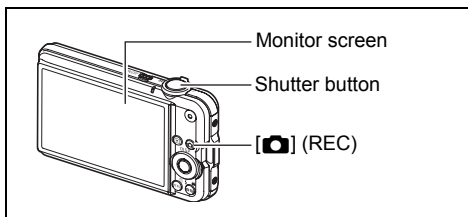
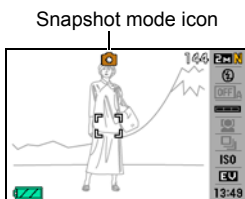

### 2. Point the camera at the subject.

You can zoom the image, if you want.

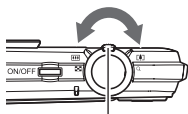

Zoom controller



 Telephoto

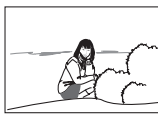

 Wide Angle

### 3. Half-press the shutter button to focus the image.

When focus is complete, the camera will beep, the back lamp will light green, and the focus frame will turn green.

Back lamp

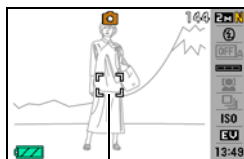
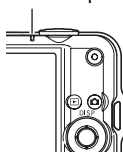

Focus frame

#### Half-press

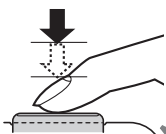

Press lightly until the button stops.

Beep, beep (Image is in focus.)

When you half-press the shutter button, the camera automatically adjusts exposure and focuses on the subject it is currently pointed at. Mastering how much pressure is required for a half-press and a full-press of the shutter button is an important technique for good-looking images.



#### 4. Continuing to keep the camera still, press the shutter button the rest of the way down.

This records the snapshot.

##### Full-press

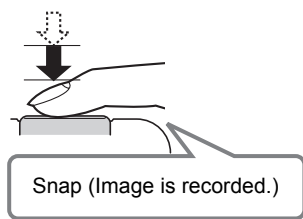

##### Shooting a Movie

Press [●] to start movie recording. Press [●] again to stop movie recording. See page 45 for details.

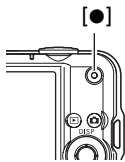

#### ■ Using Quick Shutter

Fully pressing the shutter button without waiting for Auto Focus to operate will record using Quick Shutter (page 64).

- With Quick Shutter, the camera focuses faster than normal Auto Focus, which means you can capture quick moving action more easily. Note, however, that some images may be out of focus when Quick Shutter is used.
- Whenever possible, take a little extra time to half-press the shutter button in order to ensure proper focus.

#### ■ If the image does not focus...

If the focus frame stays red and the back lamp is flashing green, it means that the image is not in focus (because the subject is too close, etc.) Re-point the camera at the subject and try to focus again.

#### ■ If the subject is not in the center of the frame...

“Focus lock” (page 60) is the name of a technique you can use when you want to shoot an image in which the subject to be focused on is not within the focus frame in the center of the screen.

## Holding the Camera Correctly

Your images will not come out clearly if you move the camera when you press the shutter button. When pressing the shutter button, be sure to hold the camera as shown in the illustration below, and keep it still by pressing your arms firmly against your sides as you shoot.

Holding the camera still, carefully press the shutter button and take care to avoid all movement as the shutter releases and for a few moments after it releases. This is especially important when available lighting is low, which slows down the shutter speed.

### Horizontal



### Vertical



Hold the camera so the flash is above the lens.

### NOTE

- Take care that your fingers and the strap do not cover any of the areas indicated in the illustration.
- To protect against accidentally dropping the camera, attach the wrist strap and make sure it is around your fingers or wrist while you are operating the camera.
- Never swing the camera around by its strap.
- The supplied strap is intended for use with this camera only. Never use it for any other purpose.

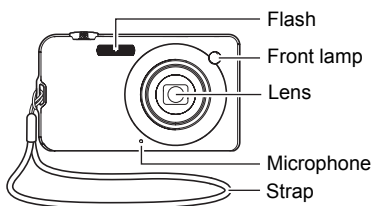

## Viewing Snapshots

Use the following procedure to view snapshots on the camera's monitor screen.

- For information about how to play back movies, see page 72.

### 1. Press [▶] (PLAY) to enter the PLAY mode.

- This will display one of the snapshots currently stored in memory.
- Information about the displayed snapshot also is included (page 151).
- You also can clear the information to view only the snapshot.
- You can zoom in on the image by sliding the zoom controller towards [▲] (page 73). If you are recording a snapshot that is very important to you, it is recommended that you zoom the image and check its details after recording it.

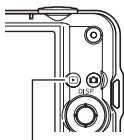

### 2. Use [◀] and [▶] to scroll between images.

- Holding down either button scrolls at high speed.



## Deleting Images

If memory becomes full, you can delete images you no longer need to free up storage and record more images.

- Remember that a file (image) delete operation cannot be undone.
- Deleting an audio snapshot (page 90) deletes both the snapshot and the audio file.

### To delete a single file

1. Press [▶] (PLAY) to enter the PLAY mode and then press [▼] (🗑️ ⚡).
2. Use [◀] and [▶] to scroll through the files until the one you want to delete is displayed.
3. Use [▲] and [▼] to select “Delete” and then press [SET].
  - To delete other files, repeat steps 2 and 3.
  - To exit the delete operation, press [MENU].

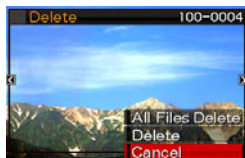

### To delete all files

1. Press [▶] (PLAY) to enter the PLAY mode and then press [▼] (🗑️ ⚡).
2. Use [▲] and [▼] to select “All Files Delete” and then press [SET].
3. Use [▲] and [▼] to select “Yes” and then press [SET] to delete all files. This will cause the message “There are no files” to appear.

## Snapshot Shooting Precautions

### Operation

- Never open the battery cover while the back lamp is flashing green. Doing so can result in the image you just shot being saved incorrectly, damage to other images stored in memory, malfunction of the camera, etc.
- If unwanted light is shining directly onto the lens, shade the lens with your hand when shooting an image.

### Monitor Screen when Shooting Snapshots

- Subject brightness conditions can cause monitor screen response to slow and can cause digital noise in the monitor screen image.
- The image that appears on the monitor screen is for image composition. The actual image will be recorded at the quality set for the image quality setting (page 67).

### Shooting Indoors under Fluorescent Lighting

- Minute flickering of fluorescent lighting can affect the brightness or color of an image.

### Auto Focus Restrictions

- Any of the following can make proper focus impossible.
  - Solid color wall or other very low contrast subject
  - Strongly back lit subject
  - Very shiny subject
  - Blinds or other subject with a repeating horizontal pattern
  - Multiple subjects at varying distances from the camera
  - Subject in a dark location
  - Subject that is too far away for light from the AF assist lamp to reach
  - Camera movement while shooting
  - Fast-moving subject
  - Subjects outside the focus range of the camera
- If you cannot focus properly, try using focus lock (page 60) or Manual Focus (page 58).

## Turning the Camera On and Off

### To turn power on

To enter the REC Mode, press [ON/OFF] (Power) or [RECORD] (REC). To enter the PLAY mode, press [PLAY] (PLAY). The back lamp will light (green) momentarily and the camera will turn on. If you are entering the REC mode, the lens will extend from the camera at this time.

- Take care to ensure that nothing is restricting or coming into contact with the lens as it extends. Holding the lens with your hand so it cannot extend creates the risk of malfunction.
- Pressing [PLAY] (PLAY) while in the REC mode switches to the PLAY mode. The lens retracts about 10 seconds after switching modes.
- The Sleep function or Auto Power Off (pages 129, 130) will turn off power automatically if you do not perform any operation for a preset amount of time.

[ON/OFF] (Power)

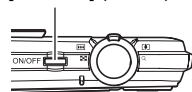

Back lamp

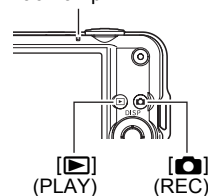

### To turn off the camera

Press [ON/OFF] (Power).

- You can configure the camera so power does not turn on when you press [RECORD] (REC) or [PLAY] (PLAY). You also can configure the camera to turn off when you press [RECORD] (REC) or [PLAY] (PLAY) (page 130).

## Using the Control Panel

The Control Panel can be used to configure camera settings.

### 1. In the REC mode, press [SET].

This will select one of the Control Panel icons and display its settings.

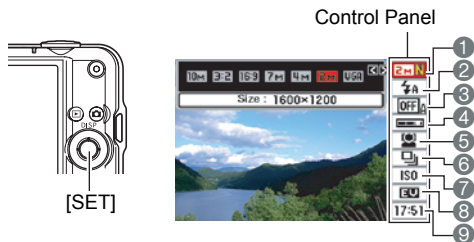

### 2. Use [▲] and [▼] to select the setting you want to change.

- |  |                                |
|--|--------------------------------|
| ① Image size/Quality* (pages 24, 67)         | ⑤ Face recognition (page 32)   |
| ② Flash mode (page 26)                       | ⑥ Continuous shutter (page 38) |
| ③ Auto Shutter (page 28)                     | ⑦ ISO sensitivity (page 40)    |
| ④ Auto Shutter trigger sensitivity (page 30) | ⑧ EV shift (page 41)           |
|  | ⑨ Date/Time (page 42)          |

\* Image quality cannot be changed using the Control Panel.

### 3. Use [◀] and [▶] to change the setting.

### 4. If you want to configure another setting, repeat steps 2 and 3.

### 5. After all of the settings are the way you want, press [SET].

This will apply the settings and return to the REC mode.

#### NOTE

- You can configure the camera to turn off display of the Control Panel when you press [SET] (page 123).
- You also can configure settings other than those listed above (page 56).
- The Control Panel cannot be displayed while a Prerecord Movie, For YouTube, or Voice Recording Operation is in progress.

## Changing the Image Size (Size)

### ■ Pixels

A digital camera image is a collection of small dots called “pixels”. The more pixels there are in an image, the more detail there will be. However, you generally can do with fewer pixels when printing an image (L size) through a print service, attaching an image to e-mail, when viewing the image on a computer, etc.

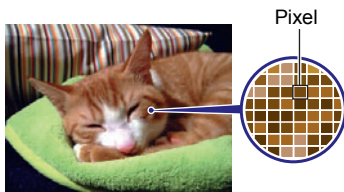

### ■ About image sizes

The size of an image indicates how many pixels it contains, and is expressed as horizontal pixels×vertical pixels.

- ① 3072×2304 size image = Approximately 7 million pixels
- ② 640×480 size image = Approximately 300,000 pixels

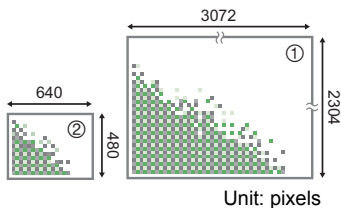

### Image Size Selection Tips

Note that larger images have more pixels, so they take up more memory space.



Large Number of Pixels

→ More detail, but takes up more memory. Best when you plan to print large-size prints (such as A3 size).



Small Number of Pixels

→ Less detail, but takes up less memory. Best when you want to send images by e-mail, etc.

- For information about image size, image quality, and number of images that can be stored, see page 161.
- For information about movie image size, see page 67.
- For information about resizing existing snapshots, see page 88.



## ■ To select the image size

1. In the REC mode, press [SET].



2. Use [▲] and [▼] to select the top Control Panel option (Image Size).

3. Use [◀] and [▶] to select an image size and then press [SET].



Image Size (Pixels)	Suggested Print Size and Application	Description
10M (3648×2736)	Poster Print	Good detail for better clarity even for images cropped (page 88) from the original
3:2 (3648×2432)	Poster Print	
16:9 (3648×2048)	HDTV	
7M (3072×2304)	A3 Print	Good detail
4M (2304×1728)	A4 Print	
2M (1600×1200)	3.5"×5" Print	Best when preserving memory capacity is relatively more important than image quality.
VGA (640×480)	E Mail	Image files are smaller, which is better when attaching images to e-mail. However, images are relatively coarser.

- The initial factory default image size setting is 10M (10 million pixels).
- Selecting 3:2 (3648×2432 pixels) records images with an aspect ratio of 3:2, which matches the standard aspect ratio of print paper.
- The letters "HDTV" stand for "High Definition Television". An HDTV screen has an aspect ratio of 16:9, which makes them wider than the usual 4:3 aspect ratio of television screens of the past. Your camera can record images that are compatible with the aspect ratio an HDTV screen.
- You should regard the print paper sizes suggested here as guidelines only (200 dpi print resolution).





## Using Flash (Flash)

1. In the REC mode, press [▼] (  ) (  ) once.

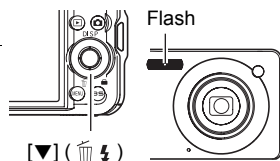
2. Use [◀] and [▶] to select the flash setting you want and then press [SET].

When the “ Panel” menu item (page 123) is “Off” (so the Control Panel is not displayed), pressing [▼] (  ) (  ) will cycle through the available flash settings.



 <b>Auto Flash</b>	Flash fires automatically in accordance with exposure (amount of light and brightness) conditions.
 <b>Flash Off</b>	Flash does not fire.
 <b>Flash On</b>	Flash always fires. This setting can be used to brighten a subject that normally comes out dark due to daylight or backlight (daylight synchro flash).
 <b>Soft Flash</b>	Soft flash always fires, regardless of exposure conditions
 <b>Red Eye Reduction</b>	Flash fires automatically. This type of flash can be used to reduce the chance of redness in the subject's eyes.

3. Press the shutter button to shoot.

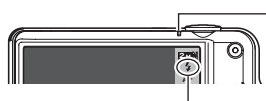

 indicates the flash will fire.

### Back lamp

Flashes orange while the flash is charging to indicate that image recording is disabled.

- You will not be able to take another flash snapshot until the lamp stops flashing orange, which indicates that charging is complete.

## NOTE

- Take care so your fingers and the strap do not block the flash.
- The desired effect may not be obtained when the subject is too far away or too close.
- Flash charging time depends on operating conditions (battery condition, ambient temperature, etc.) With a fully charged battery it takes anywhere from a few seconds to 3 seconds.
- Shooting with flash turned off when lighting is dim results in a slow shutter speed, which can cause image blur due to camera movement. Under such conditions, secure the camera with a tripod, etc.
- With red eye reduction, the flash is fired automatically in accordance with exposure. It does not fire in areas where lighting is bright.
- The presence of outdoor sunlight, fluorescent lighting, or some other light source can cause abnormal image colors.

- Select “Flash Off” for the flash setting when shooting in areas where flash photograph is prohibited.
- Approximate Flash Range (ISO Sensitivity: Auto)  
Wide Angle: 0.2 m to 2.8 m (0.7' to 9.2')  
Telephoto: 0.4 m to 1.5 m (1.3' to 4.9')
- \* The above values depend on the optical zoom setting.

### **Red-eye Reduction**

Using the flash to shoot at night or in a dimly lit room can cause red spots inside the eyes of people who are in the image. This is caused when the light from the flash reflects off of the retina of the eye. When red-eye reduction is selected as the flash mode, the camera fires a pre-flash to cause the irises in the eyes of any people in the image to close, which reduces the chance of red eye.

Note the following important points when using red-eye reduction.



- Red-eye reduction does not work unless the people in the image are looking directly at the camera (flash).
- Red-eye reduction may not work very well if the subjects are located far away from the camera.

### **Other Useful Flash Features**

- Changing the flash intensity (page 71)
- Compensating for insufficient flash intensity (page 71)

## Using Auto Shutter (Auto Shutter)

With Auto Shutter, the camera releases the shutter automatically when it detects that certain conditions are present.

 <b>Detect Blur</b>	Camera releases the shutter automatically when it detects image blur to camera and subject movement are minimized.
 <b>Detect Panning</b>	When panning, the camera releases the shutter automatically when it determines there is no blur in the subject being followed.
 <b>Detect Smile</b>	Camera releases the shutter automatically when it detects the subject is smiling.

1. In the REC mode, press [SET].
2. Use [▲] and [▼] to select the third Control Panel option from the top (Auto Shutter).
3. Use [◀] and [▶] to select the Auto Shutter type and then press [SET].

### To use Detect Blur to minimize image blur (Detect Blur)

1. Point the camera at the subject and half-press the shutter button, and wait until the camera adjusts exposure and focus automatically.
2. Press the shutter button the rest of the way down.

The camera will go into a standby mode and start detecting hand and subject movement. The camera will release the shutter automatically the moment it determines there is no image blur.

- “● Auto” flashes on the monitor screen while detection of image blur due to hand movement or subject movement is in progress.



Indicator:  
The indicator color changes from red to green when the camera is getting ready to release the shutter.

## To use Detect Panning to minimize image blur (Detect Panning)

1. Point the camera at location where the subject will pass and then half-press the shutter button to adjust exposure and focus.
2. Press the shutter button the rest of the way down.

This will put the camera into Auto Shutter standby. Move the camera to follow the movement of the subject. The camera will release the shutter automatically the moment it determines there is no blur in the subject you are following.

- “● Auto” flashes on the monitor screen while panning detection is in progress.

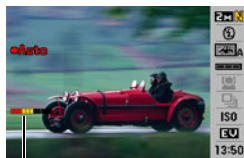

Indicator:  
The indicator color changes from red to green when the camera is getting ready to release the shutter.

## To use Detect Smile to record when a subject is smiling (Detect Smile)

1. Point the camera at the subject and half-press the shutter button, and wait until the camera adjusts exposure and focus automatically.
2. Press the shutter button the rest of the way down.

The camera will go into a standby mode and start detecting whether the subject is smiling. The camera will release the shutter automatically the moment it determines the subject is smiling.





- “● Auto” flashes on the monitor screen while smile detection is in progress.



Indicator:  
The indicator color changes from red to green when the camera is getting ready to release the shutter.

## To change Auto Shutter trigger sensitivity (Sensitivity)

---

1. In the REC mode, press [SET].
2. Use [▲] and [▼] to select the fourth Control Panel option from the top (Sensitivity).
3. Use [◀] and [▶] to select the sensitivity setting you want, and then press [SET].
  - You can select any one of three sensitivity levels, from  (Lowest) to  (Highest).
  - With the  (Highest) setting, the auto shutter release is triggered relatively easily. Auto shutter release triggering becomes more difficult with the  (Lowest) setting, but recorded images have the least blur. Experiment with Auto Shutter trigger sensitivity settings to find the one that work best for you.

### ■ Using Auto Shutter in Combination with Continuous Shutter

The following describes how Auto Shutter works while used in combination with Continuous Shutter (page 38).

- With Normal Speed Continuous Shutter, the camera will go back into Auto Shutter standby and be ready to shoot again each time it is triggered. To stop an ongoing Normal Speed Continuous Shutter operation, press [SET].
- With High-speed Continuous Shutter, 10 continuous shutter images will be shot when Auto Shutter is triggered.
- With Flash Continuous Shutter, 3 continuous shutter images will be shot with flash when Auto Shutter is triggered.

## Tips for Better Auto Shutter Snapshots

- Using Auto Shutter in combination with Anti Shake (page 62) reduces the chance of image blur even more.
- While recording with Detect Blur or Detect Smile, keep the camera as still as possible until the recording operation is complete.





### **IMPORTANT!**

- If the camera remains in Auto Shutter standby without releasing the shutter, you can record an image by pressing the shutter button all the way down again.
- Detect Blur and Detect Panning may not produce the desired effect when shooting in an area where dim lighting requires a slow shutter speed, or when the subject is moving extremely quickly.
- Since facial expressions differ from individual to individual, you may experience problems with getting the camera to release the shutter while Detect Smile is being used. If this happens, change the trigger sensitivity setting.
- The Auto Power Off (page 130) trigger time is fixed at five minutes while the camera is in Auto Shutter standby. Sleep (page 129) is disabled while Auto Shutter being used.
- To cancel Auto Shutter recording while movement, panning, or smile detection is being performed (indicated by “● Auto” flashing on the monitor screen), press [SET].
- Auto Shutter cannot be used in combination with any of the following features.
  - Some BEST SHOT sample scenes (Business cards and documents, White board, etc., Prerecord (Movie), For YouTube, Voice Recording)
- The following functions are disabled when shooting with Auto Shutter.
  - Triple Self-timer
  - Tracking AF

## Using Face Recognition (Face Recognition)

The face recognition feature adjusts focus and brightness to the faces in the image. Face recognition has two modes, described below.

 <b>Normal</b>	Detects human faces in the image.
 <b>Family First</b>	Gives priority to specific faces that have been pre-recorded as family members.

### To perform a face recognition recording operation (Normal)

- 1. In the REC mode, press [SET].**
- 2. Use [▲] and [▼] to select the fifth Control Panel option from the top (Face Recognition).**
- 3. Use [◀] and [▶] to select “ Face Detection: Normal” and then press [SET].**
- 4. Point the camera at the subject(s).**

The camera will detect human faces and display a frame around each one.
- 5. Half-press the shutter button.**

The camera will focus and the frames around the faces it focuses on will turn green.
- 6. Press the shutter button the rest of the way down.**
  - Half pressing the shutter button to perform face recognition while “ Tracking” (page 63) is selected for the AF area, will cause the focus frame to follow the movement of the face.





## Using the Family First Mode (Family First)

---

- To pre-record the faces of family members, etc.

1. In the REC mode, press [SET].
2. Use [▲] and [▼] to select the fifth Control Panel option from the top (Face Recognition).
3. Use [◀] and [▶] to select “📷 Record Family” and then press [SET].
4. With the camera pointed straight at the face of the person you want to pre-record, align the frame on the monitor screen with the face and then press the shutter button.
5. When the message “Face recognition successful!” appears, use [▲] and [▼] to select “Save” and then press [SET].



### NOTE

---

- You can pre-record a total of 12 faces, for up to six different individuals.
- Face data is stored in the camera's built-in memory, in a folder named "FAMILY" (page 115).

## ■ To assign a priority level to pre-recorded face data

You can use the procedure below to assign names and priority levels to pre-recorded faces.

**1. In the REC mode, press [SET].**

---

**2. Use [▲] and [▼] to select the fifth Control Panel option from the top (Face Recognition).**

---

**3. Use [◀] and [▶] to select “👤 Edit Family” and then press [SET].**

This will display the face data editing screen.

---

Face data editing screen



**4. Use [▲], [▼], [◀], and [▶] to select the face data you want to edit, and then press [SET].**

---

**5. Use [◀] and [▶] to select a name, and then press [▼].**

---

**6. Use [◀] and [▶] to select the priority level you want and then press [SET].**

- You can set the priority to one of four levels: • • • (Disabled: no detection), and from • • ★ (Low) to ★ ★ ★ (High).

### NOTE

- To delete pre-recorded face data, perform steps 1, 2, and 3 of the above procedure and then press [MENU]. You can use the menu to select one face data record or all face data records (page 34).
- Formatting the camera's built-in memory (page 132) deletes all the recorded face data.

## ■ To add a face data shot to an existing pre-recorded family member

Face recognition efficiency can be improved by recording three or four face data shots under various conditions for a single individual.

1. In the REC mode, press [SET].

---

2. Use [▲] and [▼] to select the fifth Control Panel option from the top (Face Recognition).

---

3. Use [◀] and [▶] to select “👤 Edit Family” and then press [SET].

---

4. Use [▲], [▼], [◀], and [▶] to select the thumbnail of face data to which you want to add another face data shot, and then press [MENU].

---

5. Use [▲] and [▼] to select “Add”, and then press [SET].

---

6. Perform steps 4 and 5 under “To pre-record the faces of family members, etc.” (page 33) to add the face data shot.

### NOTE

- Camera memory can store face data for up to six individuals, and up to 12 face data items.

## ■ To shoot a snapshot using pre-recorded face data

1. In the REC mode, press [SET].

---

2. Use [▲] and [▼] to select the fifth Control Panel option from the top (Face Recognition).

---

3. Use [◀] and [▶] to select “ Face Recognition: Family First” and then press [SET].

---

4. **Point the camera at the subject(s).**

The camera will detect human faces and display a boundary around each one.

  - The boundaries will be colored according to the priority level of the face: white (lowest), yellow, or light blue (highest). The light blue boundary indicates the highest priority face when the image is recorded.

---

5. **Half-press the shutter button.**

This will focus on the face with the highest priority (the one with the light blue boundary) and adjust its brightness. A green focus frame will appear at the highest priority face.

---

6. **When you are ready to shoot, press the shutter button the rest of the way.**

### NOTE

- Selecting the Family First mode causes the AF area setting (page 63) to change to “ Tracking” automatically.

### To give priority to detection speed or number of faces

1. In the REC mode, press [SET].

---

2. Use [▲] and [▼] to select the fifth Control Panel option from the top (Face Recognition).

---

3. Use [◀] and [▶] to select “ Priority” and then press [SET].

---

4. Use [▲] and [▼] to select the setting you want, and then press [SET].

Speed	Minimizes face recognition time, and limits the number of faces that can be detected at one time to five.
Quantity	Enables detection of a maximum of five to ten faces. With this setting, the camera recognizes faces in the image that are smaller and further away from the camera (when shooting with the Normal mode).

## Tips for Best Face Recognition Results

- Face recognition in the Family First mode is slightly faster than that in the Normal mode. Also, compared with the Normal mode, the Family First mode will not be able to detect faces that are far away and small.
- The camera performs center focus if it cannot detect a face.
- Always make sure that Auto Focus (AF) is selected as the focus mode when shooting with face recognition.
- Face recognition may take a bit longer when you hold the camera sideways.
- Even if you have the face of a family member pre-recorded, the person's facial expression, shooting conditions, or other factors can make proper detection (highest priority assignment) impossible.
- Face recognition can be improved by pre-recording multiple versions of the same person's face indoors and outdoors, with different expressions, and at different angles.
- Detection of the following types of faces is not supported.
  - Face that is obstructed by hair, sunglasses, a hat, etc., or a face in dark shade
  - A profile or a face that is at an angle
  - A face that is very far away and small, or very close and large
  - A face in an area that is very dark
  - The face of a pet or some other non-human subject





### **IMPORTANT!**

- Face recognition cannot be used in combination with any of the following features.
  - Some BEST SHOT scenes (Business cards and documents, White board, etc., Prerecord (Movie), For YouTube, Voice Recording)
  - Movie Recording
- The following functions are disabled when shooting with face recognition.
  - Multi AF

## Using Continuous Shutter (Continuous)

Your camera has three continuous shutter modes.

 <b>Normal Speed CS</b>	Continually records images until memory becomes full.
 <b>High Speed CS</b>	Continually records images at a speed that is faster than Normal-speed, until memory becomes full. Image size is fixed at 2M (1600×1200 pixels).
 <b>Flash CS</b>	Flash Continuous Shutter shoots up to three images with flash if the shutter button is kept depressed. Shooting stops if you release the shutter button before three images are recorded.

\* To turn off a continuous shutter mode, select "Off".

- 1. In the REC mode, press [SET].**

---

- 2. Use [▲] and [▼] to select the sixth Control Panel option from the top (Continuous Shutter).**

---

- 3. Use [◀] and [▶] to select the continuous shutter mode you want, and then press [SET].**



---

- 4. Press the shutter button to shoot.**

Images continue to be shot as long as you keep the shutter button depressed. Releasing the shutter button stops shooting.

## NOTE

---

- With continuous shutter, exposure and focus for the first image are applied for successive images as well.
- Continuous shutter cannot be used in combination with any of the following. Some BEST SHOT scenes (Business cards and documents, White board, etc., Prerecord (Movie), For YouTube, Voice Recording)
- The continuous shutter rate depends on the current image size and image quality settings.
- The speed of Normal-speed Continuous Shutter and High-Speed Continuous Shutter depends on the type of memory card loaded in the camera and the amount of free space available for storage. When shooting to built-in memory, continuous shutter shooting is relatively slow.
- Flash is turned off  automatically when High-speed Continuous Shutter is selected.
- With flash continuous shutter, the flash mode automatically becomes  (flash on).
- You cannot use the self-timer in combination with Normal-speed or High-speed Continuous Shutter.
- Note that images recorded with High-speed and Flash Continuous Shutter are of somewhat lower resolution and more prone to digital noise than images recorded with Normal-speed Continuous Shutter.
- The ISO sensitivity setting always is "Auto" for High-speed and Flash Continuous Shutter, regardless of the camera's current ISO sensitivity setting.
- The flash range for Flash Continuous Shutter is narrower than that for normal flash.

## Specifying ISO Sensitivity (ISO)

ISO sensitivity is a measure of sensitivity to light.

1. In the REC mode, press [SET].
2. Use [▲] and [▼] to select the seventh Control Panel option from the top (ISO Sensitivity).
3. Use [◀] and [▶] to select the setting you want and then press [SET].

<b>AUTO</b>	Adjusts sensitivity automatically according to conditions		
<b>ISO 50</b>	Lower sensitivity	Slow shutter speed	Less noise
<b>ISO 100</b>	↑ ↓	↑ ↓	↑ ↓
<b>ISO 200</b>			
<b>ISO 400</b>			
<b>ISO 800</b>			
<b>ISO 1600</b>			

- “AUTO” ISO sensitivity always is applied for movies, regardless of the current ISO sensitivity setting.



## Correcting Image Brightness (EV Shift)

You can manually adjust an image's exposure value (EV value) before shooting it.

- Exposure Compensation Range:  $-2.0\text{EV}$  to  $+2.0\text{EV}$
- Unit:  $1/3\text{EV}$

**1. In the REC mode, press [SET].**

**2. Use [▲] and [▼] to select the second Control Panel option from the bottom (EV Shift).**

**3. Use [◀] and [▶] to adjust the exposure compensation value.**

[▶]: Increases the EV value. A higher EV value is best for light-colored subjects and backlit subjects.

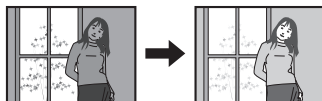

[◀]: Decreases the EV value. A lower EV value is best for dark-color subjects and for shooting outdoors on a clear day.



To cancel exposure compensation, change the EV value to 0.0.

**4. Press [SET].**

This applies the exposure compensation value.

The exposure compensation value you set remains in effect until you change it.

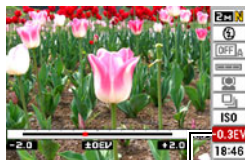

Exposure compensation value

### NOTE

- When shooting under very dark or very bright conditions, you may not be able to obtain satisfactory results even after performing exposure compensation.

## Changing the Control Panel Date/Time Style

1. In the REC mode, press [SET].
2. Use [▲] and [▼] to select the bottom Control Panel option (Date/Time).  
Use [◀] and [▶] to select the date or time.

### NOTE

- You can select either of two display style (page 128) for the date: Month/Day or Day/Month.
- The time is displayed using 24-hour format.

## Shooting with Zoom

Your camera provides you with 3X optical zoom (that changes the lens focal distance), which can be used in combination with digital zoom (that digitally processes the center portion of the image to enlarge it) for total zoom capabilities of 3X to 45.2X. The image deterioration point depends on the image size (page 44).

1. In the REC Mode, slide the zoom controller to zoom.



 Telephoto



 Wide Angle

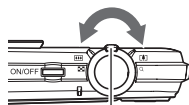

Zoom controller

 (Telephoto) :Enlarges the subject and narrows the range

 (Wide Angle):Reduces the size of the subject and broadens the range

2. Press the shutter button to shoot the image.

### IMPORTANT!

- Digital zoom is disabled while date stamping (page 127) is turned on.

## NOTE

- The higher the digital zoom factor, the coarser the recorded image. Note that the camera also has a function that lets you record using digital zoom without image deterioration (page 44).
- Use of a tripod is recommended to protect against image blur due to camera movement when shooting with telephoto.
- Performing a zoom operation changes the lens aperture.
- Digital zoom only is available during movie recording. You can adjust the optical zoom setting before you press [●] (Movie) to start movie recording.

## Optical Zoom and Digital Zoom Switch Point

If you hold the zoom controller towards [▲] (Telephoto), the zoom operation will stop when the optical zoom factor reaches its maximum. Momentarily releasing the zoom controller and then holding it again towards [▲] (Telephoto) will switch to digital zoom, which you can use to set an even higher zoom factor.

- During digital zoom, a zoom bar on the monitor screen shows the current zoom setting.

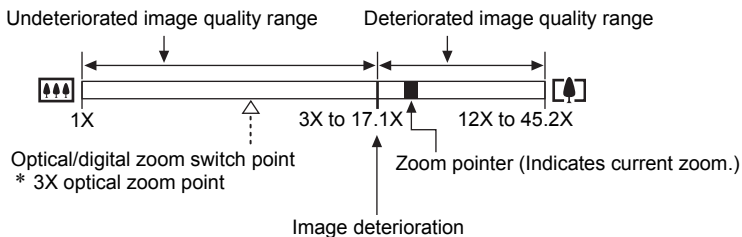
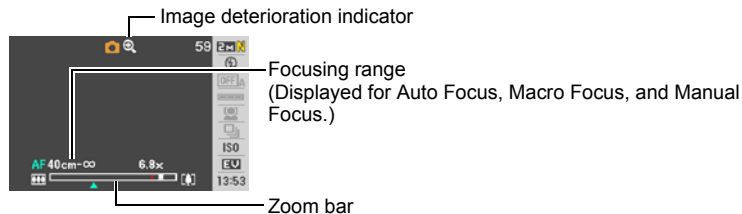

- The image deterioration point depends on the image size (page 24). The smaller the image size, the higher the zoom factor you can use before reaching the image deterioration point.

<b>Image Size</b>	<b>Maximum Zoom Factor</b>
<b>10M</b>	12X
<b>3:2</b>	12X
<b>16:9</b>	12X
<b>7M</b>	14.2X
<b>4M</b>	18.7X
<b>2M</b>	26.5X
<b>VGA</b>	45.2X

- Though digital zoom generally causes a deterioration of image quality, some digital zoom without image deterioration is possible with image sizes of "7M" and smaller. The range in which you can use digital zoom without image deterioration is indicated on the display. The deterioration point depends on the image size.

<b>Image Size</b>	<b>Undeteriorated zoom limit</b>
<b>10M</b>	3X
<b>3:2</b>	3X
<b>16:9</b>	3X
<b>7M</b>	3.6X
<b>4M</b>	4.7X
<b>2M</b>	6.8X
<b>VGA</b>	17.1X

# Recording Movie Images and Audio

## To record a movie

### 1. Configure the quality setting for the movie (page 67).

The length of the movie you can record will depend on the quality setting you select.

### 2. In the REC mode, press [●] (Movie).

This will start recording and display **REC** on the monitor screen.

Movie recording includes monaural audio.

Remaining recording time



Recording time

### 3. Press [●] again to stop recording.

- Each movie can be up to 10 minutes long. Movie recording stops automatically after 10 minutes of recording. Movie recording also will stop automatically if memory becomes full before you stop movie recording by pressing [●].

## Shooting with BEST SHOT

With BEST SHOT (page 50), you can select the sample scene that matches the type of movie you are trying to shoot and the camera will change its setup accordingly, for beautiful movies every time. Selecting the BEST SHOT scene named Night Scene, for example, will configure the camera so night scenes appear clearer and brighter.

## Minimizing the Effects of Camera Movement during Movie Recording

You can configure the camera to minimize the effects of camera movement during movie recording (page 62). Note, however, that this does not prevent image blur due to subject movement and it makes the field of view narrower.

## NOTE

- Spending a long time using movie recording will cause the camera to become slightly warm to the touch. This is normal and does not indicate malfunction.
- The camera also records audio. Note the following points when shooting a movie.
  - Take care that the microphone is not blocked by your fingers, etc.
  - Good recording results are not possible when the camera is too far away from what you are trying to record.
  - Operating camera buttons while shooting can cause button noise to be picked up in the audio.
- Shooting a very bright subject can cause a vertical band to appear in the monitor screen image. This does not indicate malfunction. The band will not be recorded in a snapshot, but will be recorded in the case of a movie.
- Use of certain types of memory cards increase the time it takes to record movies, which can cause movie frames to be lost. This condition is indicated by **MEM** and **REC** flashing on the monitor screen. To avoid loss of movie frames, use of a memory card with a maximum transfer speed of at least 10MB per second is recommended.
- Only digital zoom can be used for zooming during movie recording. Since optical zoom is not possible while recording a movie, zoom as required before pressing **[●]** to start recording.
- The effects of camera movement in an image become more pronounced when you shoot close up or with a large zoom factor. Because of this, use of a tripod is recommended under these conditions.
- Auto Focus and Macro Focus become fixed focus while shooting a movie (page 58).



## Using Prerecord Movie

With this feature, the camera prerecords up to five seconds of whatever is happening in front of the lens in a buffer that is continually updated. Pressing [●] saves the prerecorded action (buffer contents) followed by real-time recording. Real-time recording continues until you stop it.

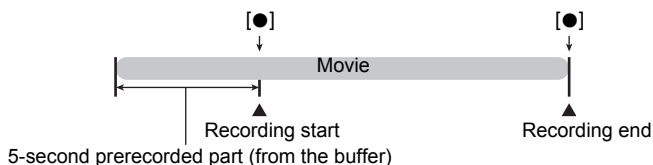

### ■ To set up the camera to shoot with Prerecord Movie

1. In the REC mode, press [BS] (🔒).
2. Use [▲], [▼], [◀], and [▶] to select the “Prerecord (Movie)” scene and then press [SET].  
This causes  to appear on the monitor screen.

### ■ To shoot a Prerecord Movie

1. With the camera pointed at the subject, press [●].  
This will save five seconds of action prerecorded in the buffer and start real-time recording.
2. Press [●] again to stop recording.
  - To turn off Prerecord Movie, press [BS] (🔒) and then select  (Auto).

## Shooting a Snapshot while Shooting a Movie

### 1. While a movie is being recorded, press the shutter button.

Movie recording continues after the snapshot is recorded.

#### NOTE

- You can use [▼] (  ) while shooting a movie to change the flash mode setting.
- Movie recording is interrupted for a few seconds at the point where a snapshot is recorded.
- Shooting a snapshot during movie recording is not possible while any one of the following BEST SHOT scenes is selected.  
Prerecord (Movie), Business cards and documents, White board, etc., For YouTube, Voice Recording

## Recording Audio Only (Voice Recording)

Voice Recording lets you record audio only, without a snapshot or movie. You can record about 36 minutes and 52 seconds of Voice Recording using the camera's built-in memory only.

### 1. In the REC mode, press [BS] ( ).

### 2. Use [▲], [▼], [◀], and [▶] to select the “Voice Recording” scene and then press [SET].

This causes  to appear on the monitor screen.

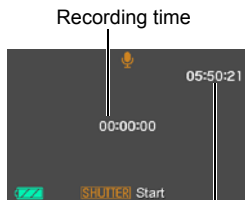

### 3. Press the shutter button to start recording.

- The back lamp flashes green while recording is in progress.
- Pressing [SET] during recording will insert a marker into the recording. During playback, you will be able to jump to the markers in the recording.



Remaining recording time

### 4. Press the shutter button again to stop audio recording.

- To create another audio recording file, repeat steps 3 and 4.
- To turn off Voice Recording, press [BS] (  ) and then select  (Auto).



## About audio data

- Audio files can be played back on a computer with Windows Media Player or QuickTime.
  - Audio Data: WAVE/IMA-ADPCM (WAV extension)
  - Audio File Size: Approximately 165KB (Approximately 30 seconds of recording at 5.5KB per second)

## To play back an audio recording

1. In the PLAY mode, use [◀] and [▶] to display the Voice Recording file you want to play.

 is displayed in place of an image for a Voice Recording file.



2. Press [SET] to start playback.

## Voice Recording Playback Controls

Fast forward/fast reverse	[◀] [▶]
Play/pause	[SET]
Jump to marker	While playback is paused, press [◀] or [▶] to jump to the next marker and then press [SET] to resume playback.
Volume adjustment	Press [▼] and then press [▲] [▼]
Monitor screen on/off	[▲] (DISP)
Playback end	[MENU]

# Using BEST SHOT

## What is BEST SHOT?

BEST SHOT provides you with a collection of sample “scenes” that show a variety of different types of shooting conditions. When you need to change the setup of the camera, simply find the scene that matches what you are trying to achieve, and the camera sets up for it automatically. This helps to minimize the chance of ruined images due to poor exposure and shutter speed settings.

## Some Sample Scenes

			
Portrait	Scenery	Night Scene	Night Scene Portrait

## To shoot an image with BEST SHOT

### 1. In the REC mode, press [BS] ( ).

This will display a menu of BEST SHOT scenes.

- The initial default selection is (Auto).

### 2. Use [▲], [▼], [◀], and [▶] to move the boundary to the scene you want to select.

- The scene menu has multiple pages. Use [▲] and [▼] to scroll between menu pages.
- You can access information about the currently selected scene. See page 51 for details.
- To return to normal snapshot recording, select Scene 1 (Auto). Pressing [MENU] while the scene selection screen or scene information screen is displayed will cause the boundary to jump directly to (Auto).

Currently selected scene (with boundary)

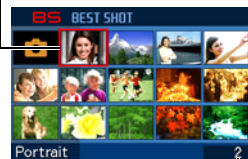

Scene name

Scene number

### 3. Press [SET] to configure the camera with the settings for the currently selected scene.

This returns to the REC mode.

- The settings of the scene you selected remain in effect until you select a different scene.
- To select a different BEST SHOT scene, repeat the above procedure from step 1.

---

#### 4. Press the shutter button (if you are shooting a snapshot) or [●] (if you are shooting a movie).

##### NOTE

- The BEST SHOT YouTube scene sets up the camera for recording movies that are optimized for uploading to YouTube. Movies recorded with the YouTube scene are stored in a special folder to make them easy to locate for uploading (page 105). Maximum recording time while the YouTube scene is selected is 10 minutes.

#### ■ Using Scene Information Screen

To find out more about a scene, select it with the boundary on the scene selection screen, and then slide the zoom controller in either direction.

- To return to the scene menu, slide the zoom controller again.
- To scroll between scenes, use [◀] and [▶].
- To configure the camera with the settings for the currently selected scene, press [SET]. To return to the scene information screen for the currently selected BEST SHOT scene, press [BS] (🔒).

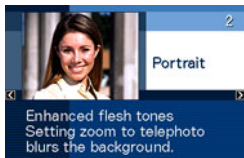

#### ■ BEST SHOT Precautions

- The following BEST SHOT scenes cannot be used while recording a movie: Self-portrait (1 person), Self-portrait (2 people), Business cards and documents, White board, etc.
- The following BEST SHOT scenes cannot be used while shooting a snapshot: Pre-record (Movie), For YouTube.
- The Voice Recording scene cannot be used while shooting a snapshot or recording a movie.
- Selecting the Night Scene or Fireworks scene results in a slow shutter speed setting. Since a slow shutter speed increases the chance of digital noise in the image, the camera automatically performs a digital noise reduction process when either of these scenes is selected. This means that it will take a bit longer for the image to be saved which is indicated by the back lamp flashing green. Do not perform any key operation during that time. Also, it is a good idea to use a tripod to avoid image blur due to camera movement when shooting at slow shutter speeds.
- Your camera includes a sample scene that optimizes settings for auction site images. Depending on your camera model, the sample scene is named either "For eBay" or "Auction". Images you record using the auction site sample scene are stored in a special folder so you can easily find them on your computer (page 115).

- High Sensitivity
  - The high sensitivity setting is disabled whenever the camera's flash fires.
  - High sensitivity may not produce the desired results in very dark conditions.
  - When shooting with slow shutter speeds, use a tripod to protect against blurring due to camera movement.
  - Under certain lighting conditions, the camera will perform an automatic noise filtering operation to reduce digital noise in the image. This operation causes the camera to take longer than normal to save the image and be ready for the next shot.
- BEST SHOT scene images were not shot using this camera.
- Images shot using a BEST SHOT scene may not produce the results you expected due to shooting conditions and other factors.
- You can modify the camera settings that are made after you select a BEST SHOT scene. Note, however, that the BEST SHOT settings revert to their defaults when you select another BEST SHOT scene or turn off the camera.

---

## Creating Your Own BEST SHOT Setups

---

You can save up to 999 camera setups as user BEST SHOT scenes for instant recall whenever you need them.

- 1. On the BEST SHOT scene menu, select the scene named BEST SHOT (Register User Scene).**

---
- 2. Use [◀] and [▶] to select the snapshot or movie whose setup you want to save.**

---
- 3. Use [▲] and [▼] to select "Save", and then press [SET].**

Your BEST SHOT scene will be assigned the name "Recall User Scene", along with a scene number.

## NOTE

- BEST SHOT snapshot scenes can be used for snapshots only and movie scenes can be used for movies only.
- You can check the settings of the currently selected BEST SHOT scene by displaying the camera's setting menus and looking at its settings.
- User snapshot scenes are assigned numbers in the sequence: SU1, SU2, and so on, while movies are assigned numbers in the sequence: MU1, MU2, and so on.
- The following are the settings that are saved for each user snapshot BEST SHOT scene.

Face Recognition, Focus, EV Shift, White Balance, Flash, ISO, Metering, Dynamic Range, Portrait Refiner, Flash Intensity, Flash Assist, Color Filter, Sharpness, Saturation, Contrast

- The following are the settings that are saved for each user movie BEST SHOT scene.  
Focus, EV Shift, White Balance, Color Filter, Sharpness, Saturation, Contrast
- User BEST SHOT scenes are stored in built-in memory (page 115) in the SCENE folder (snapshots) or MSCENE folder (movies).
- Formatting the camera's built-in memory (page 132) deletes all user BEST SHOT scenes.
- Use the following procedure when you want to delete a user BEST SHOT scene.
  - ① Display the information screen (page 51) of the user BEST SHOT scene you want to delete.
  - ② Press [▼] (  ), select "Delete", and then press [SET].

## Shooting Images of Business Cards and Documents

The Business Shot scenes of BEST SHOT produce images in which lines are straight and natural, even if rectangular subjects are shot from an angle. This process is called "keystone correction".

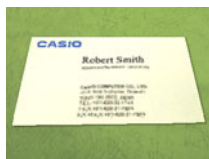

Before keystone correction

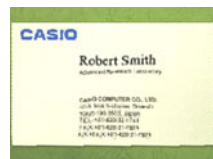

After keystone correction

BEST SHOT has two Business Shot scenes.



Business cards and documents

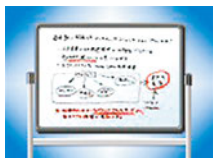

White board, etc.



## Recording a Self-portrait

With this feature, you can shoot your own self-portrait simply by pointing the camera at your face.

BEST SHOT has two self-portrait scenes from which to choose.

- Self-portrait (1 person): Shoots when the face of at least one person, including you, is detected.
- Self-portrait (2 people): Shoots when the faces of at least two people, including you, are detected.

### 1. Press [BS] (📷) and then select “Self-portrait (1 person)” or “Self-portrait (2 people)”.

### 2. Press the shutter button all the way down, and point the camera at yourself.

The camera will go into Auto Shutter standby and detect the faces of any people in the image.

When the camera is able to detect the number of required individuals, it will release the shutter automatically when it determines there is no image blur.

- The camera will emit a shutter sound and the front lamp will flash twice when the shutter is released.
- To cancel Auto Shutter standby, press [SET].



### NOTE

- You can shoot with the self-portrait feature in combination with a continuous shutter (CS) mode (page 38). Operation is the same as that when a continuous shutter (CS) mode is used in combination with Auto Shutter. See page 30 for more information.

### IMPORTANT!

- If the camera remains in Auto Shutter standby without releasing the shutter, you can record an image by pressing the shutter button all the way down again.
- Shooting with the self-portrait feature may produce a blurred image when shooting in areas where lighting is dim, which results in a very slow shutter speed setting.
- The Auto Power Off (page 130) trigger time is fixed at five minutes while the camera is in Auto Shutter standby. Sleep (page 129) is disabled while Auto Shutter being used.

# Advanced Settings

The following are menu operations you can use to configure various camera settings.

- You also can use the Control Panel (page 23) to configure some of the settings that appear on the menu screen. Refer to the page references provided in this section for information about configuring settings using the Control Panel.

## Using On-screen Menus

### ■ Example Menu Screen Operation

Press [MENU] to display the menu screen.

- Menu contents are different in the REC mode and PLAY mode.

Example: REC mode menu

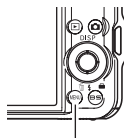
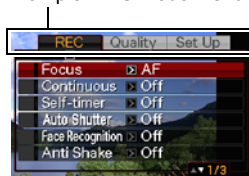

[MENU]

### Menu Screen Operation Buttons

[◀] [▶]	Selects tabs. [▶] is also used to display the options available for a setting.
[▲] [▼]	Selects a setting option.
[SET]	Registers the selected setting.
[MENU]	Exits the menu screen.

#### 1. In the REC mode, press [MENU].

This will display the menu screen.

#### 2. Use [◀] and [▶] to select the tab where the item you want to configure is located.



3. Use [▲] and [▼] to select the menu item you want, and then press [▶].

4. Use [▲] and [▼] to change the setting.

5. After the setting is the way you want, press [SET].

- Pressing [◀] registers the selected setting and returns to the menu.
- To configure settings on another tab after pressing [◀] to return to the menu, use [▲] to move the highlighting up to the tabs, and then use [◀] and [▶] to select the tab you want.

Example:  
When "Focus" is selected on the "REC" tab

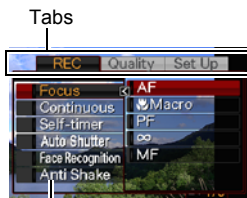

Settings

## ■ Menu Operations in This Manual

Menu operations are represented in this manual as shown below. The following operation is the same one described under "Example Menu Screen Operation" on page 56.

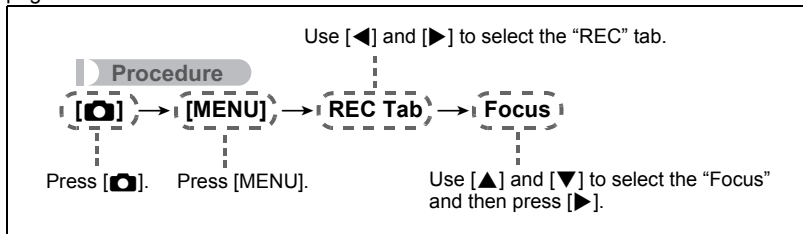

## REC Mode Settings (REC)

### Selecting a Focus Mode (Focus)

#### Procedure

[] (REC) → [MENU] → REC Tab → Focus

Settings	Type of Shot	Focus Mode		Approximate Focus Range* <sup>1</sup>	
		Snapshot	Movies	Snapshot	Movies
<b>AF</b> Auto Focus	General recording	Automatic	Fixed focal point	Approximately 40 cm to ∞ (infinity) (1.3' to ∞)	Fixed distance* <sup>2</sup> , * <sup>4</sup>
<b>Ⓜ</b> Macro	Close ups	Automatic		Approximately 15 cm to 50 cm (5.9" to 19.7")	
<b>PF</b> Pan Focus	Shooting with a relatively wide focus range	Fixed focal point		Fixed distance* <sup>2</sup> , * <sup>3</sup>	
<b>∞</b> Infinity	Scenery and other distant subjects	Fixed		Infinity	
<b>MF</b> Manual Focus	When you want to focus manually	Manual		Approximately 15 cm to ∞ (infinity)* <sup>2</sup> (5.9" to ∞)	

\*<sup>1</sup> The focus range is the distance from the lens surface.

\*<sup>2</sup> The minimum changes along with the optical zoom setting.

\*<sup>3</sup> The distance depends on shooting conditions, and appears on the monitor screen when the shutter button is half-pressed.

Zoom Steps	Normal		Macro
	Close Up	Telephoto	Center distance
Z1 (Wide)	Approx. 0.70 (2.3')	$\infty$	0.20 (7.9")
2	Approx. 0.80 (2.6')	$\infty$	0.30 (11.8")
3	Approx. 1.00 (3.3')	$\infty$	0.40 (15.7")
4	Approx. 1.20 (3.9')	$\infty$	0.40 (15.7")
5	Approx. 1.60 (5.2')	$\infty$	0.40 (15.7")
6	Approx. 2.00 (6.6')	$\infty$	0.45 (17.7")
7 (Tele)	Approx. 2.50 (8.2')	$\infty$	0.45 (17.7")

**NOTE**

- Above values are for reference only.  
For movie macro, the focus range is a few centimeters within the center distance.

**To focus with manual focus**

**1. On the monitor screen, compose the image so the subject you want to focus on is within the yellow boundary.**

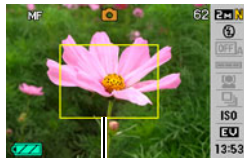

Yellow boundary

**2. Watching the image on the monitor screen use [◀] and [▶] to adjust focus.**

- At this time the image that is within the boundary will enlarge and fill the monitor screen, which aids in focusing. If you do not perform any operation for two seconds while the enlarged image is displayed, the screen in step 1 will re-appear.

**NOTE**

- An Auto Macro feature detects how far the subject is from the lens and automatically selects either Macro Focus or Auto Focus accordingly.
- Use of the flash together with Macro Focus can cause the light of the flash to become blocked, which may result in unwanted lens shadows in your image.
- Auto Macro can be used when recording snapshots only.
- Whenever you perform an optical zoom operation while shooting with Auto Focus, Macro Focus, or Manual Focus, a value will appear on the monitor screen to tell you the focus range, as shown below.



Example: ○○ cm to  $\infty$

\* ○○ is the actual focusing range value.

- The operations assigned to the [◀] and [▶] keys with the "L/R Key" setting (page 64) are disabled while Manual Focus is selected as the focus mode.

## Using Focus Lock

“Focus lock” is a technique you can use when you want to compose an image in which the subject you want to focus on is not within the focus frame in the center of the screen.

- To use focus lock, select “ Spot” or “ Tracking” for the Auto Focus area (page 63).

- 1. Align the monitor screen’s focus frame with the subject you want to focus on and then half-press the shutter button.**

Subject to be focused on

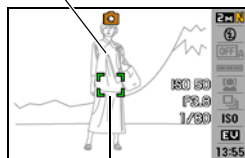

Focus Frame

- 2. Keeping the shutter button half-pressed (which maintains the focus setting), move the camera to compose the image.**

- When “ Tracking” is selected as the Auto Focus area, the focus frame will move automatically and follow the subject.

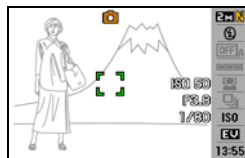

- 3. When you are ready to shoot the image, press the shutter button the rest of the way down.**

- Focus lock also locks exposure (AE).

## Using Continuous Shutter (Continuous)

### Procedure

[] (REC) → [MENU] → REC Tab → Continuous



For details, see the Control Panel procedure on page 38.

## Using the Self-timer (Self-timer)

### Procedure

[] (REC) → [MENU] → REC Tab → Self-timer

With the Self-timer, pressing the shutter button starts a timer. The shutter is released and the image is shot after a fixed amount of time.

 10 sec	10-second Self-timer
 2 sec	2-second Self-timer <ul style="list-style-type: none"><li>When shooting under conditions that slow down the shutter speed, you can use this setting to prevent image blur due to camera movement.</li></ul>
 X3 (Triple Self-timer)	Shoots three images: one image 10 seconds after the shutter button is pressed, and the next two images as soon as the camera is ready after shooting the previous image. How long it takes for the camera to get ready to shoot depends on the image size and quality settings, whether or not a memory card is loaded in the camera, and the flash charge condition.
Off	Turns off the Self-timer.

- The front lamp flashes while the Self-timer countdown is in progress.
- You can interrupt an ongoing Self-timer countdown by pressing [SET].

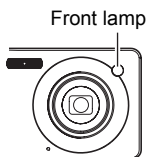

### NOTE

- The Self-timer cannot be used together with the following features. Normal-speed Continuous Shutter, High-speed Continuous Shutter, some BEST SHOT scenes (Prerecord (Movie), Voice Recording)
- The Triple Self-timer cannot be used together with the following features. Auto Shutter, Flash Continuous Shutter, Movie, some BEST SHOT scenes (Business cards and documents, White board, etc., For YouTube)

## Using Auto Shutter (Auto Shutter)

### Procedure

[] (REC) → [MENU] → REC Tab → Auto Shutter

For details, see the Control Panel procedure on page 28.

## Shooting with Face Recognition (Face Recognition)

### Procedure

[] (REC) → [MENU] → REC Tab → Face Recognition

For details, see the Control Panel procedure on page 32.

## Reducing the Effects of Camera and Subject Movement (Anti Shake)

### Procedure

[] (REC) → [MENU] → REC Tab → Anti Shake

You can turn on the camera's Anti Shake feature to reduce image blur due to subject movement or camera movement when shooting a moving subject using telephoto, when shooting a fast-moving subject, or when shooting under dim lighting conditions.

<b>Auto</b>	Minimizes the effects of hand and subject movement.
<b>Off</b>	Turns off Anti Shake settings



### NOTE

- ISO sensitivity, aperture, and shutter speed do not appear on the monitor screen when you half-press the shutter button while "Auto" is selected. These values will appear briefly, however, in the preview image that is displayed immediately after you shoot a snapshot.
- If the flash fires, the Anti Shake icon () will remain on the display, even though Anti Shake does not function during flash photography.
- Shooting with Anti Shake can cause an image to appear somewhat coarser than normal and can cause slight deterioration of image resolution.
- Anti Shake may not be able to eliminate the effects of camera or subject movement when movement is severe.

## Specifying the Auto Focus Area (AF Area)

### Procedure

[CAMERA] (REC) → [MENU] → REC Tab → AF Area

 Spot	This mode takes readings of a small area in the center of the image. This setting works well with focus lock (page 60).
 Multi	When you half-press the shutter button while this setting selected, the camera will select the optimum Auto Focus area from among nine possible areas. The focus frame of the area where the camera focuses will be displayed in green.
 Tracking	When you half-press the shutter button while this setting is selected, the focus frame will follow the movement of the subject.

“Spot” or “Tracking”



Focus frame

“Multi”

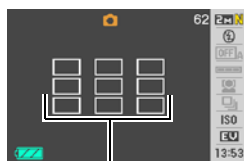

Focus frame

- “Multi” cannot be selected for the Auto Focus area while you are using Face Recognition (page 32).
- “Tracking” cannot be selected for the Auto Focus area while you are using Auto Shutter (page 28).

## Using the Auto Focus Assist Light (AF Assist Light)

### Procedure

[CAMERA] (REC) → [MENU] → REC Tab → AF Assist Light

Half-pressing the shutter button while this setting is selected causes the front lamp to light, which provides illumination for focusing in areas where lighting is dim. Leaving this function turned off is recommended when shoot portraits from short distances, etc.

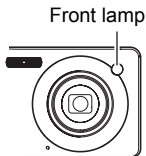

### IMPORTANT!

- Never look directly into the front lamp while it is lit.

## Turning Digital Zoom On or Off (Digital Zoom)

### Procedure

[] (REC) → [MENU] → REC Tab → Digital Zoom

You can use this setting to turn digital zoom on or off. When digital zoom is turned off, operating the zoom controller zooms the image with optical zoom only.

## Assigning Functions to the [◀] and [▶] Keys (L/R Key)

### Procedure

[] (REC) → [MENU] → REC Tab → L/R Key

You can assign one of the five functions listed below to the [◀] and [▶] keys.

Setting	[◀]/[▶] key operation
Metering	Changes the Metering Mode (page 69)
EV Shift	Adjusts the EV shift value (page 41)
White Balance	Changes the white balance setting (page 68)
ISO	Changes the ISO Sensitivity setting (page 40)
Self-timer	Sets the self-timer time (page 61)
Off	Cancels [◀] and [▶] key assignments

## Shooting with Quick Shutter (Quick Shutter)

### Procedure

[] (REC) → [MENU] → REC Tab → Quick Shutter

When Quick Shutter is turned on, you can press the shutter button all the way without waiting for Auto Focus. This will record the image using a high-speed focus operation that is much faster than Auto Focus.

<b>On</b>	Turns on Quick Shutter <ul style="list-style-type: none"><li>Some images may be out of focus when Quick Shutter is used.</li></ul>
<b>Off</b>	Turns off Quick Shutter so focus is performed using normal Auto Focus before the image is recorded. <ul style="list-style-type: none"><li>If you press fully the shutter button while Quick Shutter is turned off, images will continue to be shot without focusing.</li><li>Whenever possible, take a little extra time to half-press the shutter button in order to ensure proper focus.</li></ul>

### NOTE

- Quick Shutter is disabled when the zoom factor is greater. Recording is performed using Auto Focus at this time.



## Displaying the On-screen Grid (Grid)

---

### Procedure

[] (REC) → [MENU] → REC Tab → Grid

The on-screen grid can be displayed on the REC mode monitor screen for easy vertical and horizontal alignment when composing images.

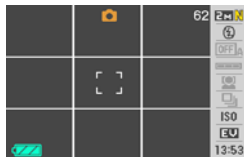

## Turning on Image Review (Review)

---

### Procedure

[] (REC) → [MENU] → REC Tab → Review

While Review is turned on, the camera will display a image for about one second immediately after you press the shutter button to record it.

## Using Icon Help (Icon Help)

---

### Procedure

[] (REC) → [MENU] → REC Tab → Icon Help

While Icon Help is turned on, a textual description will appear on the display for certain icons when you switch between REC functions.

### Functions Supported by Icon Help

- REC Mode, Flash, Metering Mode, White Balance, Self-timer, EV Shift

## Configuring Power On Default Settings (Memory)

### Procedure

[] (REC) → [MENU] → REC Tab → Memory

When you turn off the camera, it remembers the current settings of all enabled memory items and restores them when you turn it back on. Any memory item that is disabled will be returned to its initial default setting whenever you turn off the camera.

Setting	Disabled (Initial Default Setting)	Enabled
 BEST SHOT	Snapshot (Auto)	Setting at power off
Auto Shutter	Off	
Flash	Auto	
Focus	AF (Auto Focus)	
White Balance	Auto	
ISO	Auto	
AF Area	Spot	
Metering	Multi	
Continuous	Off	
Self-timer	Off	
Flash Intensity	0	
Digital Zoom	On	
MF Position	Position before manual focus was selected.	
Zoom Position*	Full wide	

\* Optical zoom setting only.

- If you turn the camera power off and then back on while the BEST SHOT memory item is enabled, all of the other memory items (except for zoom position) are initialized to the currently selected BEST SHOT sample scene setup, regardless of the enabled/disabled status of the other memory items.

## Image Quality Settings (Quality)

### Specifying Snapshot Size (Size)

#### Procedure

[] (REC) → [MENU] → Quality Tab → Size

For details, see the Control Panel procedure on page 25.

### Specifying Snapshot Image Quality (Quality (Snapshot))

#### Procedure

[] (REC) → [MENU] → Quality Tab →  Quality (Snapshot)

<b>Fine</b>	Gives image quality priority
<b>Normal</b>	Normal
<b>Economy</b>	Gives number of images priority

- The “Fine” setting helps to bring out details when shooting a finely detailed image of nature that includes dense tree branches or leaves, or an image of a complex pattern.
- Memory capacity (the number of images you can record) will be affected by the quality settings you configure (page 161).

### Specifying Movie Image Quality (Quality (Movie))

#### Procedure

[] (REC) → [MENU] → Quality Tab →  Quality (Movie)

Movie image quality is a standard that determines the detail, smoothness, and clarity of a movie during playback. Shooting with the high-quality (HQ) setting will result in better image quality, but it also shortens the amount of time you can shoot.

Image Quality (Pixels)		Approximate Data Rate	Frame Rate
UHQ	640×480	5.8 Megabits/second	30 frames/second
UHQ Wide	848×480	7.0 Megabits/second	
HQ	640×480	3.8 Megabits/second	
HQ Wide	848×480	4.4 Megabits/second	
Normal	640×480	2.1 Megabits/second	15 frames/second
LP	320×240	545 kilobits/second	

## Correcting Image Brightness (EV Shift)

### Procedure

[] (REC) → [MENU] → Quality Tab → EV Shift







For details, see the Control Panel procedure on page 41.

## Controlling White Balance (White Balance)

### Procedure

[] (REC) → [MENU] → Quality Tab → White Balance

You can adjust white balance to match the source of light available where you are shooting and avoid the blue cast that results when shooting outdoors when it is cloudy, and the green cast that results when shooting under fluorescent lighting.

<b>Auto</b>	Configures the camera to adjust white balance automatically
 <b>(Daylight)</b>	For shooting outdoors on a clear day
 <b>(Overcast)</b>	For shooting outdoors on an overcast rainy day, in the shade, etc.
 <b>(Shade)</b>	For shooting on a clear day in the shade of trees or buildings
 <b>(Day White Fluorescent)</b>	For shooting under white or day white fluorescent lighting
 <b>(Daylight Fluorescent)</b>	For shooting under daylight fluorescent lighting
 <b>(Tungsten)</b>	For shooting under light bulb lighting
<b>Manual</b>	<p>For configuring the camera manually to suit a particular light source.</p> <ol style="list-style-type: none"><li>① Select "Manual".</li><li>② Under the lighting conditions you plan to use when shooting, point the camera at a blank white piece of paper so it fills the entire monitor screen and then press the shutter button.</li><li>③ Press [SET].</li></ol> <p>The white balance setting is retained even if you turn off the camera.</p>

Blank white paper



- When "Auto" is selected for the white balance setting, the camera automatically determines the white point of the subject. Certain subject colors and light source conditions can cause problems when the camera tries to determine the white point, which makes proper white balance adjustment impossible. If this happens, select the white balance setting that matches your shooting conditions (Daylight, Overcast, etc.)

## Specifying ISO Sensitivity (ISO)

### Procedure

[] (REC) → [MENU] → Quality Tab → ISO



For details, see the Control Panel procedure on page 40.

## Specifying the Metering Mode (Metering)

### Procedure

[] (REC) → [MENU] → Quality Tab → Metering

The metering mode determines what part of the subject is metered for exposure.

 <b>Multi</b>	Multi-pattern metering divides the image into sections and measures the light in each section for a balanced exposure reading. This type of metering provides error-free exposure settings for a wide range of shooting conditions.
 <b>Center Weighted</b>	Center weighted metering concentrates on the center of the focus area to measure light. This type of metering is best when you want some level of control over contrast.
 <b>Spot</b>	Spot metering takes readings at a very small area. Use this metering method when you want exposure to be set according to the brightness of a particular subject, without being affected by surrounding conditions.

- The currently selected metering mode is indicated by an icon on the snapshot screen. No icon is displayed when “Multi” is selected as the metering mode.

## Reducing Overexposure and Underexposure (Dynamic Range)

### Procedure

[] (REC) → [MENU] → Quality Tab → Dynamic Range

You can adjust the Dynamic Range setting in order to capture the bright areas of an image while reducing the chance of overexposure and underexposure.

<b>Expand +2</b>	Suppresses overexposure and underexposure more than "Expand +1"
<b>Expand +1</b>	Suppresses overexposure and underexposure
<b>Off</b>	No suppression of overexposure and underexposure

- You also can change the dynamic range of a photograph you have already shot (page 82).

## Enhancing Skin Tones in a Portrait (Portrait Refiner)

### Procedure

[] (REC) → [MENU] → Quality Tab → Portrait Refiner

<b>Noise Filter +2</b>	Reduces skin texture roughness more than "Noise Filter +1"
<b>Noise Filter +1</b>	Reduces skin texture roughness
<b>Off</b>	Turns off skin texture enhancement

## Using Built-in Color Filters (Color Filter)

### Procedure

[] (REC) → [MENU] → Quality Tab → Color Filter

Settings: Off, B/W, Sepia, Red, Green, Blue, Yellow, Pink, and Purple

## Controlling Image Sharpness (Sharpness)

### Procedure

[] (REC) → [MENU] → Quality Tab → Sharpness

You can specify one of five sharpness settings from +2 (sharpest) to -2 (least sharp).

## Controlling Color Saturation (Saturation)

### Procedure

[] (REC) → [MENU] → Quality Tab → Saturation

You can specify one of five saturation settings from +2 (most saturated) to -2 (least saturated).

## Adjusting Image Contrast (Contrast)

---

### Procedure

[] (REC) → [MENU] → Quality Tab → Contrast

You can specify one of five contrast settings from +2 (most contrast between light and dark) to -2 (least contrast between light and dark).

## Specifying Flash Intensity (Flash Intensity)

---

### Procedure

[] (REC) → [MENU] → Quality Tab → Flash Intensity

You can specify one of five flash intensity settings, from -2 (weakest) to +2 (strongest).

- Flash intensity may not change when the subject is too far away or too close.

## Turning On Flash Assist (Flash Assist)

---

### Procedure

[] (REC) → [MENU] → Quality Tab → Flash Assist

The subject in an image will look too dark if flash intensity is not enough to reach a subject that is too far away. When this happens, you can use flash assist to supplement the brightness of the subject so it appears as if flash illumination was sufficient. Select “Auto” to turn on Flash Assist.



Flash assist turned off



Flash assist turned on

# Viewing Snapshots and Movies

## Viewing Snapshots

See page 19 for the procedure for viewing snapshots.

## Viewing a Movie

1. Press [▶] (PLAY) and then use [◀] and [▶] to display the movie you want to view.
2. Press [SET] to start playback.

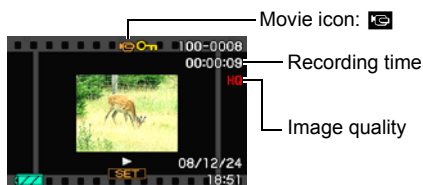

## Movie Playback Controls

<b>Fast forward/ fast reverse</b>	[◀] [▶] <ul style="list-style-type: none"><li>• Each press of either button increases the speed of the fast forward or fast reverse operation.</li><li>• To return to normal playback speed, press [SET].</li></ul>
<b>Play/pause</b>	[SET]
<b>1 frame forward/back</b>	[◀] [▶] <ul style="list-style-type: none"><li>• Holding down either button scrolls continuously.</li></ul>
<b>Volume adjustment</b>	Press [▼] and then press [▲] [▼] <ul style="list-style-type: none"><li>• Volume can be adjusted only while movie playback is in progress.</li></ul>
<b>Information display on/off</b>	[▲] (DISP)
<b>Zoom</b>	Slide the zoom controller in the direction of [⬆] (Q). <ul style="list-style-type: none"><li>• You can use [▲], [▼], [◀], and [▶] to scroll the zoomed image on the monitor screen. You can zoom a movie image up to 4.5 times normal size.</li></ul>
<b>Stop playback</b>	[MENU]

- Playback may not be possible for movies not recorded with this camera.



## Zooming an On-screen Image

1. In the PLAY mode, use [◀] and [▶] to scroll through the images until the one you want is displayed.

2. Slide the zoom controller towards [🔍] (🔍) to zoom.

You can use [▲], [▼], [◀], and [▶] to scroll the zoomed image on the monitor screen. Slide the zoom controller towards [🔍] to unzoom the image.

- If display indicators are turned on, an indicator in the lower right corner of the monitor screen shows what part of the zoomed image is currently displayed.
- To exit the zoom screen, press [MENU] or [BS] (🔑).
- Though the maximum image zoom factor is 8X, certain image sizes may not allow zooming up to the full 8X.

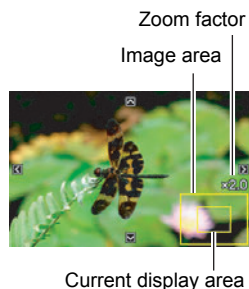

## Displaying 12 Images on the Same Screen

1. In the PLAY Mode, slide the zoom controller towards [🔍] (🔍).

Use [◀] and [▶] to scroll, 12 images at a time.



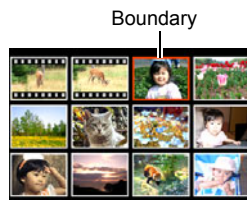

To view a particular image, use [▲], [▼], [◀], or [▶] to move the selection boundary to the image you want and then press [SET].



## Displaying Images in the Calendar Screen

### 1. In the PLAY Mode, slide the zoom controller towards () twice.

This will display the calendar screen that shows the first image recorded on each day.

To display the first image recorded on a particular day, use [, [, [, and [] to move the selection boundary to the day you want and then press [SET].

To exit the calendar screen, press [MENU] or [BS]

().

- If you save an image using any one of the following functions, the image will appear in the calendar on the date that you last saved it.

Dynamic Range, White Balance, Brightness, Keystone Correction, Color Restoration, Resizing, Cropping, Copy, Layout Print, MOTION PRINT





If you edit the date and time of an image, the image still will appear on the date it was originally recorded.



## Using Image Roulette

### 1. With the camera turned off, hold down [] and [] (PLAY) until the Image Roulette screen appears on the monitor screen.

The Image Roulette screen will cycle randomly through all the snapshots that are currently in memory and finally stop at one.

- To perform the Image Roulette operation again, press [] or [].
- To exit the Image Roulette screen, press [] (REC) to enter the REC Mode or [ON/OFF] to turn off the camera.
- For a rotated snapshot (page 87), the Image Roulette screen shows the unrotated version.
- The camera will exit Image Roulette automatically if you do not perform the next Image Roulette operation within about one minute after the final image of the previous operation appears on the monitor screen.
- Note that Image Roulette works only with images shot with this camera. Image Roulette may not operate properly when other types of images are in memory.
- You can use Image Roulette only when [] (REC) and [] (PLAY) operations (page 130) are configured for “Power On” or “Power On/Off”.

## Viewing Snapshots and Movies on a TV Screen

### 1. Use the AV cable that comes with the camera to connect it to the TV.

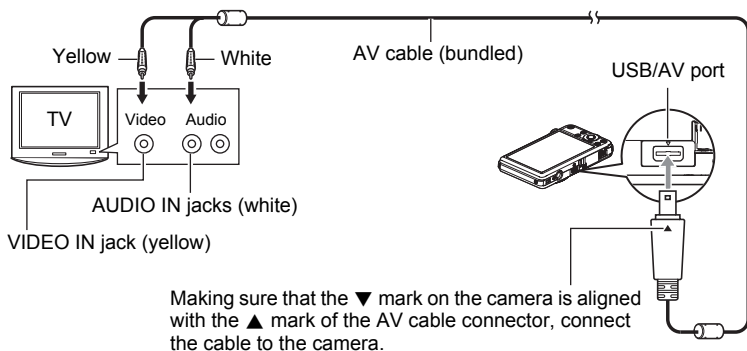

- Make sure that you insert the cable connector into the USB/AV port until you feel it click securely into place. Failure to insert the connector fully can result in poor communication or malfunction.
- Note that even while the connector is fully inserted, you still will be able to see the metal part of the connector as shown in the illustration.

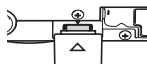

### 2. Turn on the TV and select its video input mode.

If the TV has more than one video input, select the one where the camera is connected.

### 3. Press [▶] (PLAY) to turn on the camera.

This will cause an image to appear on the TV screen, without anything appearing on the camera's monitor screen.

- Pressing [ON/OFF] or [📷] (REC) will not turn on the camera while the AV cable is connected.
- You also can change the aspect ratio of the screen and the video output system (page 131).

### 4. Now you can display images and play back movies as you normally do.

## NOTE

---

- Audio is monaural.
- Certain TVs may cut off part of the images.
- Before connecting to a TV to display images, be sure to configure the camera's [RECORD] (REC) and [PLAY] (PLAY) buttons for "Power On" or "Power On/Off" (page 130).
- Audio is initially output by the camera at maximum volume. When you first start displaying images, set the TV volume control at a relatively low level and then adjust it as required.
- All icons and indicators that appear on the monitor screen also appear on the TV screen. You can use [DISP] (DISP) to change the display contents.

### Recording Camera Images to a DVD Recorder or Video Deck

Use one of the following methods to connect the camera to the recording device using the camera's bundled AV cable.

- DVD recorder or video deck: Connect to the VIDEO IN and AUDIO IN terminals.
- Camera: USB/AV port

You can play a slideshow of snapshots and movies on the camera and record it on a DVD or video tape. You can record movies by selecting "Still Only" for the slideshow "Images" setting (page 77). When recording images to an external device, use [DISP] (DISP) to clear all indicators from the monitor screen (page 123).

For information about connecting a monitor to the recording device and about how to record, see the user documentation that comes with the recording device you are using.

## Other Playback Functions (PLAY)







This section explains menu items that you can use to configure settings and perform other playback operations.

For information about menu operations, see page 56.

### Playing a Slideshow on the Camera (Slideshow)

#### Procedure

[] (PLAY) → [MENU] → PLAY Tab → Slideshow

<b>Start</b>	Starts the slideshow
<b>Images</b>	Specifies the type of images to be included in the slideshow All images: Snapshots, movies, and audio recordings  Only: Snapshots and audio snapshots only  Only: Movies only One Image: One single selected image (selected using [  ] and [  ])
<b>Time</b>	Time from the start to the end of the slideshow 1 to 5 minutes, 10 minutes, 15 minutes, 30 minutes, 60 minutes
<b>Interval</b>	Amount of time each image remains displayed Use [  ] and [  ] to select a value from 1 to 30 seconds, or "MAX". If you specify a value from 1 to 30 seconds, images change at the specified interval, but the audio portion of movies and audio snapshots will continue to play until the end. When the slideshow reaches a movie file while "MAX" is selected, only the first frame of the movie will be displayed. Voice Recording files are not played back when "MAX" is selected.
<b>Effect</b>	Select the effect you want. Pattern 1 to 5: Plays background music and applies an image change effect. <ul style="list-style-type: none"><li>• Patterns 1 through 4 have different background music, but they all use the same image change effect.</li><li>• Pattern 5 can be used for playback of snapshots only, and the "Interval" setting is ignored.</li><li>• The currently selected image change effect setting is disabled automatically in following cases.<ul style="list-style-type: none"><li>– When playing a slideshow for which " Only" or "One Image" is selected for the "Images" setting</li><li>– When the interval setting is 1 second or 2 seconds.</li><li>– Before and after playback of a movie or Voice Recording file</li></ul></li></ul> Off: No image change effect or background music

- To stop the slideshow, press [SET]. Pressing [MENU] instead of [SET] stops the slideshow and returns to the menu screen.
- Adjust audio volume by pressing [▼] and then press [▲] or [▼] during playback.
- All button operations are disabled while the slideshow is transitioning from one image to another.
- The time required for transition from one image to another may be longer in the case of an image that was not recorded with this camera.

## **Saving Music from Your Computer to Camera Memory**

---

You can replace the built-in slideshow background music with other music from your computer.

### **Supported File Types:**

- IMA-ADPCM format WAV files
- Sampling Frequencies: 22.05 kHz/44.1 kHz
- Quality: Monaural

### **Number of Files: 9**

### **File names: SSBGM001.WAV to SSBGM009.WAV**

- Create the music files on your computer using the above names.
- Regardless of which effect pattern you select, the BGM files you store in camera memory are played back in name sequence.

### **1. Connect the camera to your computer (pages 101, 111).**

If you plan to save the music files to the camera's memory card, make sure the card is loaded in the camera.

---

### **2. Perform one of the following operations to open the memory card or built-in memory.**

This will cause the camera to be recognized by your computer as a Removable Disk (Drive).

- Windows
  - ① Windows XP: Start → My Computer  
Windows Vista: Start → Computer  
Windows 2000, Me, 98SE, or 98: Double-click "My Computer".
  - ② Double-click "Removable Disk".
- Macintosh
  - ① Double-click the camera's drive icon.

---

### **3. Create a folder named "SSBGM".**

---

**4. Double-click the “SSBGM” folder you created and copy the background music file to it.**

- See the user documentation that comes with your computer for information about moving, copying, and deleting files.
- If there are background music files both in built-in memory and on the memory card loaded in the camera, the files on the memory card take priority.
- See page 115 for information about camera folders.

---



**5. Disconnect the camera from the computer (pages 102, 111).**

## Laying Out Snapshots with Layout Print (Layout Print)

### Procedure

[] (PLAY) → [MENU] → PLAY Tab → Layout Print

You can use the following procedure to insert existing snapshots into the frames of a layout and produce a new image that contains multiple snapshots.

**1. Use [] and [] to select the layout pattern you want and then press [SET].**



Layout Pattern  
(2 images)



Layout Pattern  
(3 images)

---

**2. Use [] and [] to select the background color and then press [SET].**

---

**3. Use [] and [] to select the images you want to include in the layout then press [SET].**

---

**4. Press [SET] and repeat step 3 for the remaining frames in the layout.**  
The final layout image will be saved after you insert the final snapshot into it.

## NOTE

- You will not be able to save the new image unless there is a snapshot in all of the layout frames.
- 3:2 and 16:9 images cannot be included in a Layout Print image.
- The recording date of the resulting Layout Print image is the recording date if the image you place into the final frame, not the date you create the Layout Print image.
- The Layout Print image is saved as 7M (3072×2304 pixels) size.

## Creating a Snapshot of Movie Frames (MOTION PRINT)

### Procedure

[] (PLAY) → Movie Screen → [MENU] → PLAY Tab → MOTION PRINT

1. Use [] and [] to select either “9 frames” or “1 frame”.



When “9 frames” is selected, the frame you select in step 2 will be in the center of the MOTION PRINT image.

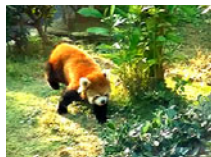

9 frames



1 frame

2. Use [] and [] to scroll through the movie frames and display the one you want to use as the image of the MOTION PRINT image.

Holding down [] or [] scrolls at high speed.

3. Press [SET].

- Only the frames of movies recorded on this camera can be used in a MOTION PRINT image.







## Editing a Movie on the Camera (Movie Editing)



### Procedure



[] (PLAY) → Movie Screen of Movie to be Edited → [MENU] → PLAY Tab → Movie Editing

The Movie Editing feature lets you use one of the following procedures to edit out a specific part of a movie.

 <b>Cut (To-Point Cut)</b>	Cuts everything from the beginning of the movie up to the current location.
 <b>Cut (Point-To-Point Cut)</b>	Cuts everything between two points.
 <b>Cut (From-Point Cut)</b>	Cuts everything from the current location to the end of the movie.

1. Use [] and [] to select the editing method you want to use and then press [SET].





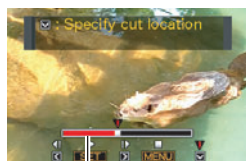

2. Use [] and [] to scroll through the movie and search for the frame (point) from which or to which you want to cut the movie (the cut point).

- You also can search for the cut location by playing back the movie and pressing [SET] to pause. During playback, you can press [] or [] to perform fast reverse or fast forward.



Cut range (red)

3. When the frame where you want the cut point to be is displayed, press [].

 <b>Cut (To-Point Cut)</b>	While the frame you want the cut to be up to is displayed, press [  ].
 <b>Cut (Point-To-Point Cut)</b>	① While the frame you want the first (From) cut to be is displayed, press [  ]. ② While the frame you want the second (To) cut to be is displayed, press [  ].
 <b>Cut (From-Point Cut)</b>	While the frame you want the cut to be from is displayed, press [  ].

4. Use [] and [] to select “Yes” and then press [SET].

The selected cut operation will take considerable time to complete. Don't try to perform any camera operation until the “Busy... Please wait...” message disappears from the monitor screen. Note that a cut operation can take a long time if the movie being edited is long.

## NOTE

- When you edit a movie, only the result is saved. The original movie is not retained. An editing operation cannot be undone.
- A movie that is shorter than five seconds cannot be edited.
- Editing of movies recorded with a different type of camera is not supported.
- You will not be able to edit a movie if the amount of remaining memory capacity is less than the size of the movie file you want to edit. If there is not enough memory available, delete files you no longer need to free up more.
- Splitting of a movie into two movies and splicing of two different movies into a single movie are not supported.
- You also can start a movie editing operation while the movie you want to edit is playing back. Press [SET] to pause playback, and then press [▼] to display the menu of editing options. Perform editing using the same procedures as described above.

## Reducing the Effects of Underexposure (Dynamic Range)

### Procedure

[▶] (PLAY) → Snapshot Screen → [MENU] → PLAY Tab → Dynamic Range

This setting can be used to suppress underexposure, while maintaining image brightness.

<b>Expand +2</b>	Suppresses underexposure more than “Expand +1”
<b>Expand +1</b>	Suppresses underexposure
<b>Cancel</b>	No suppression of underexposure

## NOTE







- You also can adjust the dynamic range when recording images (page 70).
- Altering the dynamic range of an image causes the original image and the new (altered) version to be stored as separate files.
- When you display an altered image on the camera's monitor screen, the date and time indicates when the image was originally recorded, not when the image was altered.

## Adjusting White Balance (White Balance)

### Procedure

[] (PLAY) → Snapshot Screen → [MENU] → PLAY Tab → White Balance

You can use the white balance setting to select a light source type for a recorded image, which will affect the colors of the image.

 Daylight	Outdoors, fair weather
 Overcast	Outdoors, cloudy to rain, in tree shade, etc.
 Shade	Very high temperature light, such as building shade, etc.
 Day White Fluorescent	White or daylight fluorescent lighting, without suppressing color cast
 Daylight Fluorescent	White or daylight fluorescent lighting, while suppressing color cast
 Tungsten	Suppressing of the appearance of light bulb lighting
Cancel	No white balance adjustment

### NOTE

- You also can adjust the white balance when recording images (page 68).
- Altering the white balance of an image causes the original image and the altered version to be stored as separate files.
- When you display an altered image on the camera's monitor screen, the date and time indicates when the image was originally recorded, not when the image was altered.

## Adjusting the Brightness of an Existing Snapshot (Brightness)

### Procedure

[**▶**] (PLAY) → Snapshot Screen → [MENU] → PLAY Tab → Brightness

You can select one of five brightness levels, from +2 (brightest) to -2 (least bright).

- When you display an altered image on the camera's monitor screen, the date and time indicates when the image was originally recorded, not when the image was altered.

## Keystone Correction (Keystone)

### Procedure

[**▶**] (PLAY) → Snapshot Screen → [MENU] → PLAY Tab → Keystone

You can use keystone correction to correct rectangular and square shapes in a snapshot that do not appear normal because they were not shot straight on. The corrected image is saved as 2M (1600×1200 pixels) size.

**1. Use [**◀**] and [**▶**] to select the shape in the snapshot that you want to correct.**

**2. Use [**▲**] and [**▼**] to select "Correct" and then press [SET].**

- If the original image is smaller than 2M (1600×1200 pixels) size, the new (corrected) version will be the same size as the original.
- The original snapshot is retained in memory and not deleted.
- When you display an altered image on the camera's monitor screen, the date and time indicates when the image was originally recorded, not when the image was altered.



## Using Color Correction to Correct the Color of an Old Photograph (Color Correction)

### Procedure

[] (PLAY) → Snapshot Screen → [MENU] → PLAY Tab → Color Correction

Color Correction lets you correct the color of an old photograph. The corrected image is saved as 2M (1600×1200 pixels) size.

#### 1. Perform the above operation.

- An image of the photograph you are restoring will appear on the monitor screen with a red boundary around it. If there is a black boundary, it means that the camera detected more than one rectangular area in the image. Use [◀] and [▶] to move the boundary and select the area of the photograph.

---

#### 2. Use [▲] and [▼] to select “Trim”, and then press [SET].

This will display a selection boundary for trimming the on-screen image.

---

#### 3. Slide the zoom controller to resize the selection boundary and specify the image size you want.

---

#### 4. Use [▲], [▼], [◀], and [▶] to move the selection boundary to it encloses the area of the image you want to trim to and then press [SET].

### NOTE

- If the original image is smaller than 2M (1600×1200 pixels) size, the new (corrected) version will be the same size as the original.
- The original snapshot is retained in memory and not deleted.
- If you do not want a border around the resulting image, select an area that is smaller than the original image.
- When you display a color corrected image on the camera’s monitor screen, the date and time indicates when the image was originally recorded, not when the image was color corrected.

## Selecting Images for Printing (DPOF Printing)

### Procedure



[▶] (PLAY) → [MENU] → PLAY Tab → DPOF Printing

See page 95 for details.

## Protecting a File Against Deletion (Protect)

### Procedure

[▶] (PLAY) → [MENU] → PLAY Tab → Protect

<b>On</b>	<p>Protects specific files.</p> <ol style="list-style-type: none"><li>① Use [◀] and [▶] to scroll through the files until the one you want to protect is displayed.</li><li>② Use [▲] and [▼] to select "On" and then press [SET]. An image that is protected is indicated by the  icon.</li><li>③ To protect other files, repeat steps 1 and 2.</li></ol> <p>To exit the protect operation, press [MENU]. To unprotect a file, select "Off" instead of "On" in step 2 above.</p>	
<b>All Files: On</b>	<p>Protects all files.</p> <ol style="list-style-type: none"><li>① Use [▲] and [▼] to select "All Files: On" and then press [SET].</li><li>② Press [MENU].</li></ol> <p>To unprotect all files, select "All Files: Off" instead of "All Files: On" in step 1 above.</p>	

- Note that even if a file is protected, it will be deleted if you perform the format operation (page 132).

## Editing the Date and Time of an Image (Date/Time)

### Procedure

[▶] (PLAY) → Snapshot Screen → [MENU] → PLAY Tab → Date/Time

[▲][▼]	Changes the setting at the cursor location
[◀][▶]	Moves the cursor between settings
[BS] (🔒)	Toggles between 12-hour and 24-hour format

When the date and time settings are what you want, press [SET] to apply them.

### NOTE

- The date and time stamped into an image using the Time Stamp (page 127) cannot be edited.
- You cannot edit the date and time of an image that is protected.
- You can input any date from 1980 to 2049.

## Rotating an Image (Rotation)

### Procedure

[▶] (PLAY) → Snapshot or Movie Screen → [MENU] → PLAY Tab → Rotation

- 1. Use [▲] and [▼] to select “Rotation” and then press [SET].**  
Each press of [SET] will rotate the displayed image 90 degrees left.
- 2. When the displayed image is at the orientation you want, press [MENU].**

### NOTE

- Note that this procedure does not actually change the image data. It simply alters how the image is displayed on the camera’s monitor screen.
- An image that has been protected or zoomed cannot be rotated.
- The original (unrotated) version of the image will be displayed on the 12-image screen, the calendar screen, and image roulette.

## Resizing a Snapshot (Resize)

### Procedure

[▶] (PLAY) → Snapshot Screen → [MENU] → PLAY Tab → Resize

You can reduce the size of a snapshot and save the result as a separate snapshot. The original snapshot is also retained. You can select resize an image to one of three image sizes: 7M, 4M, VGA.

- Resizing a 16:9 or 3:2 size snapshot will create an image with an aspect ratio of 4:3, with both sides cut off.
- The recording date of the resized version of the snapshot will be the same as the recording date of the original snapshot.

## Cropping a Snapshot (Trimming)

### Procedure

[▶] (PLAY) → Snapshot Screen → [MENU] → PLAY Tab → Trimming

You can crop a snapshot to trim parts you do not need, and save the result in a separate file. The original snapshot is also retained.

Use the zoom controller to zoom the image to the size you want, use [▲], [▼], [◀], and [▶] to display the portion of the image you want to cut out, and then press [SET].

- The image produced by cropping a 3:2 or 16:9 image will have an aspect ratio of 4:3.
- The recording date of the cropped image will be the same as the recording date of the original snapshot.

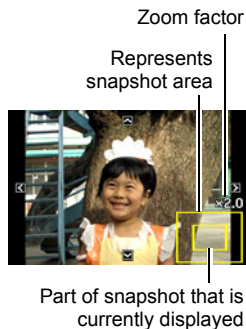



## Adding Audio to a Snapshot (Dubbing)

### Procedure

[] (PLAY) → Snapshot Screen → [MENU] → PLAY Tab → Dubbing

You can add audio to a snapshot after you shoot it. You can re-record a snapshot's audio whenever you want. You can record up to about 30 seconds of audio for a single snapshot.

#### 1. Press the shutter button to start audio recording.



Remaining recording time

#### 2. Press the shutter button again to stop audio recording.

- Take care that you do not block the camera's microphone with your fingers while recording.
- Good recording results are not possible when the camera is too far away from what you are trying to record.
- Your camera supports the following audio data formats.
  - Audio Format: WAVE/IMA-ADPCM (WAV extension)
  - Approximate Audio File Size:  
165KB (Approximately 30 seconds of recording at 5.5KB per second)
- Adding audio (dubbing) is not possible for the following types of images.
  - Images created using MOTION PRINT
  - Protected images
- To delete audio, perform the following operation:  
Dubbing → Delete → [SET] → [MENU].



#### **IMPORTANT!**

- Note that you cannot restore the original audio of an Audio Snapshot after you delete or re-record it.

## To play snapshot audio

1. In the **PLAY** mode, use [◀] and [▶] to scroll through the images until the **Audio Snapshot** you want is displayed.

An audio snapshot is one that has a  icon.

2. Press [SET] to start playback.

### Voice Recording Playback Controls

<b>Fast forward/fast reverse</b>	[◀] [▶]
<b>Play/pause</b>	[SET]
<b>Volume adjustment</b>	Press [▼] and then press [▲] [▼]
<b>Display content switching</b>	[▲] (DISP)
<b>Stop playback</b>	[MENU]







- Audio of an Audio Snapshot also can be played back on a computer with Windows Media Player or QuickTime.

## Copying Files (Copy)

### Procedure

[] (PLAY) → Snapshot Screen → [MENU] → PLAY Tab → Copy

Files can be copied from the camera's built-in memory to a memory card or from a memory card to built-in memory.

<b>Built-in → Card</b>	Copies all files from built-in camera memory to a memory card. This option copies all the files in built-in camera memory. It cannot be used to copy a single file.
<b>Card → Built-in</b>	Copies a single file on the memory card to camera built-in camera memory. Files are copied to the folder in built-in memory whose name has the largest serial number. ① Use [  ] and [  ] to select the file you want to copy. ② Use [  ] and [  ] to select "Copy" and then press [SET].

### NOTE

- You can copy snapshots, movies, audio snapshots, or Voice Recording files you recorded with this camera.
- When a copied image appears on the full-month calendar screen, it is displayed on the date that it was copied (page 74).

## Printing Snapshots

### Professional Print Service

You can take a memory card that contains the images you want to print to a professional print service and have them printed.



### Printing on a Home Printer

#### Printing Images on a Printer with Memory Card Slot

You can use a printer equipped with a memory card slot to print images directly from a memory card. For details, see the user documentation that comes with your printer.



#### Connecting Directly to a PictBridge Compatible Printer

You can print on a printer that supports PictBridge (page 93).



### Printing with a Computer

#### Windows Computer

Install the software (Photo Loader with HOT ALBUM) that comes bundled with the camera on your computer.

- For details, see "To install Photo Loader with HOT ALBUM" on page 104.

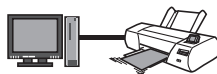

#### Macintosh

After transferring the images to your Macintosh, use commercially available software to print.

- You can specify which images you want to print, the number of copies, and date stamp settings before printing (page 95).

## Connecting Directly to a PictBridge Compatible Printer

You can connect the camera directly to a printer that supports PictBridge and print images without going through a computer.

### ■ To set up the camera before connecting to a printer

1. Turn on the camera and press [MENU].
2. On the “Set Up” tab, select “USB” and then press [▶].
3. Use [▲] and [▼] to select “PTP (PictBridge)”, and then press [SET].

### ■ Connecting the Camera to a Printer

Use the USB cable that comes bundled with the camera to connect the camera to your printer's USB port.

- The camera does not draw power over the USB cable. Make sure the camera's battery is sufficiently charged before connecting.
- Make sure that you insert the cable connector into the USB/AV port until you feel it click securely into place. Failure to insert the connector fully can result in poor communication or malfunction.
- Note that even while the connector is fully inserted, you still will be able to see the metal part of the connector as shown in the illustration.
- When connecting the USB cable to a USB port, make sure you align the connector correctly with the port.

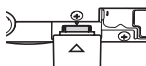
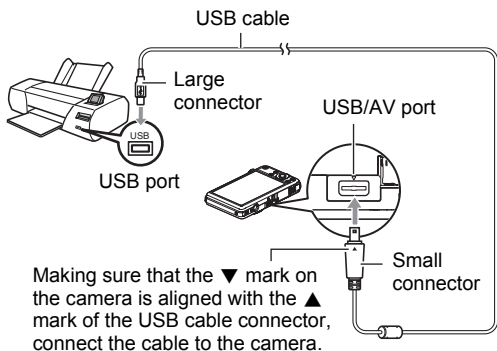

### ■ To print

1. Turn on the printer and load paper.
2. Turn on the camera.  
This will display the print menu screen.
3. Use [▲] and [▼] to select “Paper Size”, and then press [▶].



---

#### 4. Use [▲] and [▼] to select a paper size and then press [SET].

- The following are the available paper sizes.  
3.5"×5", 5"×7", 4"×6", A4, 8.5"×11", By Printer
- Selecting "By Printer" prints using a paper size selected on the printer.
- See the documentation that comes with your printer for information about paper settings.

---

#### 5. Use [▲] and [▼] to specify the print option you want.

1 Image : Prints one image. Select and then press [SET]. Next, use [◀] and [▶] to select the image you want to print.

DPOF Printing : Prints multiple images. Select and then press [SET]. With this option, images will be printed in accordance with DPOF settings (page 95).

- To toggle date stamping on and off, press [BS] ( ). The date stamp will be printed when "On" is indicated on the monitor screen.



---

#### 6. Use [▲] and [▼] to select "Print" and then press [SET].

Printing will start and the message "Busy... Please wait..." will appear on the monitor screen. The message will disappear after a short while, even though printing is still being performed. Pressing any camera button will cause the printing status to re-appear. The print menu screen will re-appear when printing is complete.

- If you selected "1 Image", you can repeat the procedure from step 5, if you want.

---

#### 7. After printing is complete, turn off the camera and disconnect the USB cable from the printer and camera.

## Using DPOF to Specify Images to be Printed and the Number of Copies

### ■ Digital Print Order Format (DPOF)

DPOF is a standard that allows you to include image type, number of copy, and time stamp on/off information on the memory card with the images. After configuring settings, you can use the memory card to print on a home printer that supports DPOF or take the memory card to a professional print service.



- Whether or not you will be able to use DPOF settings for printing depends on the printer you are using.
- Some professional print services may not support DPOF.

### ■ Configuring DPOF Settings Individually for Each Image

#### Procedure

[] (PLAY) → [MENU] → PLAY Tab → DPOF Printing → Select images

1. Use [] and [] to scroll through the files until the image you want to print is displayed.

---

2. Use [] and [] to specify the number of copies.  
You can specify a value up to 99. Specify 00 if you do not want to print the image.
  - If you want to include the date in the images, press [BS] () so "On" is shown for date stamping.
  - Repeat steps 1 and 2 to configure settings for other images, if you want.

---

3. Press [SET].

### ■ Configuring the Same DPOF Settings for All the Images

#### Procedure

[] (PLAY) → [MENU] → PLAY Tab → DPOF Printing → All images

1. Use [] and [] to specify the number of copies.  
You can specify a value up to 99. Specify 00 if you do not want to print the image.
  - If you want to include the date in the images, press [BS] () so "On" is shown for date stamping.

---

2. Press [SET].

**DPOF settings are not cleared automatically after printing is complete.**

The next DPOF print operation you execute will be performed using the last DPOF settings you configured for the images. To clear DPOF settings, specify “00” for the number of copies of all images.

**Tell your print service about your DPOF settings!**

If you take a memory card to a professional print service, be sure to tell them that it includes DPOF settings for the images to be printed and the number of copies. If you don't, the print service may print all the images without regard to your DPOF settings, or they may ignore your date stamp setting.

**■ Date Stamping**

You can use one of the following three methods to include the recording date in the printout of an image.

<b>Configuring camera settings</b>	Configure DPOF settings (page 95). You can turn date stamping on and off each time you print. You can configure settings so some images include the date stamp and some don't.
	Configure the Camera's Time Stamp setting (page 127). <ul style="list-style-type: none"><li>• The camera's Time Stamp setting imprints the date into a snapshot when you shoot it, so the date is always included when you print. It cannot be deleted.</li><li>• Do not turn on DPOF date stamping for an image that includes a date stamped with the camera's Time Stamp function. Doing so can cause the two stamps to be overprinted.</li></ul>
<b>Configuring computer settings</b>	You can stamp dates into images using the bundled Photo Loader with HOT ALBUM (page 99) software (Windows only).
<b>Professional print service</b>	Request date stamping when ordering prints from a professional print service.



## ■ Standards Supported by the Camera

- PictBridge

This is a standard of the Camera and Imaging Products Association (CIPA).



- PRINT Image Matching III

Using image editing software and printing on a printer that supports PRINT Image Matching III makes it possible to use information about shooting conditions that is recorded with the image, and produce exactly the type of image you want. PRINT Image Matching and PRINT Image Matching III are trademarks of Seiko Epson Corporation.



- Exif Print





Printing on a printer that supports Exif Print (Exif 2.2) uses information about shooting conditions recorded with the image to enhance printed image quality. Contact your printer manufacturer for information about models that support Exif Print, printer upgrades, etc.



# Using the Camera with a Computer

## Things you can do using a computer...

You can perform the operations described below while the camera is connected to a computer.

<b>Save images to a computer and view them there</b> 	<ul style="list-style-type: none"><li>• Save images and view them manually (USB connection) (pages 101, 110).</li><li>• Save images and view them automatically (Photo Loader with HOT ALBUM*) (page 104). Images will be grouped by recording date and displayed in a calendar format.</li></ul>
<b>Transfer images stored on your computer to camera memory</b> 	In addition to images, you also can transfer screen shot images from your computer to the camera (Photo Transport*) (page 107).
<b>Playback and edit movies</b> 	<ul style="list-style-type: none"><li>• You can play back movies using QuickTime 7 (pages 105, 113).</li><li>• To edit movies, use commercially available software as required.</li></ul>
<b>Transfer document data to the camera</b> 	You can transfer screen shots of documents, digital books, web pages, and more to camera memory and take them along anywhere (CASIO DATA TRANSPORT) (page 117).

\* Windows only

The procedures you need to perform when using the camera with your computer and when using the bundled software are different for Windows and the Macintosh.

- Windows users should refer to "Using the Camera with a Windows Computer" on page 99.
- Macintosh users should refer to "Using the Camera with a Macintosh" on page 110.

## Using the Camera with a Windows Computer

Install the required software in accordance with the version of Windows you are running and what you want to do.

When you want to do this:	Operating System Version	Install this software:	See page:
Save images to a computer and view them there manually	Vista / XP / 2000 / Me	Installation not required.	101
	98SE / 98	<b>USB driver Type B</b> • You can download the USB driver from the Official CASIO Digital Camera Website at <a href="http://www.exilim.com/">http://www.exilim.com/</a>	101
Save images to a computer automatically/ Manage images	Vista / XP / 2000	<b>Photo Loader with HOT ALBUM 3.1</b> <b>DirectX 9.0c</b> (When DirectX 9.0 or higher is not already installed on the computer.)	104
Play movies	Vista / XP (SP2) / 2000 (SP4)	<b>QuickTime 7</b>	105
Edit movies	Vista / XP / 2000 / Me / 98SE / 98	– • Use commercial software as required.	–
Upload movie files to YouTube	Vista / XP (SP2) / 2000 (SP4)	<b>YouTube Uploader for CASIO</b>	105
Transfer images to the camera	Vista / XP / 2000 / Me / 98SE / 98	<b>Photo Transport 1.0</b>	107
Transfer document data to the camera	Vista / XP / 2000	<b>CASIO DATA TRANSPORT 1.0</b>	117

When you want to do this:	Operating System Version	Install this software:	See page:
View the User's Guide	Vista / XP (SP2) / 2000 (SP4)	<b>Adobe Reader 8</b> (Not required if already installed.)	108
	Me / 98SE / 98	— • If your computer does not already have Adobe Reader or Adobe Acrobat Reader installed, go to the Adobe Systems Incorporated website to download and the version of Adobe Reader or Adobe Acrobat Reader that is compatible with your computer's operating system.	—

### ■ Computer System Requirements for Bundled Software

Computer system requirements are different for each of the applications. See the "Read me" file that comes with each application for details. Information about computer system requirements also can be found under "Computer System Requirements for Bundled Software" on page 147 of this manual.

### ■ Precautions for Windows Vista Users

- Photo Transport will not run under 64-bit versions of Windows Vista.
- Except for DirectX, Adobe Reader, and QuickTime, the bundled software requires Administrator privileges to run.
- Operation on a self-made computer or under a dual-processor environment is not supported.
- Operation may not be possible under certain computer environments.
- Photo Loader with HOT ALBUM provides a function for migrating image data previously saved with Photo Loader, which means you still will have access to your existing image archives.

## Viewing and Storing Images on a Computer

You can connect the camera to your computer in order to view and store images (snapshot and movie files).

**If your computer is running Windows 98SE or 98, you need to install the USB driver (page 99).**

You can download the USB driver from the Official CASIO Digital Camera Website at <http://www.exilim.com/>

**If your computer is running Windows 98SE or 98, never connect the camera to your computer without first installing the USB driver!**

If you do, the computer will not be able to recognize the camera. If your computer is running Windows 98SE or 98, be sure to install the USB driver first. Do not connect the camera to your computer without installing the USB driver first.

### ■ To connect the camera to your computer and save files

1. Turn on the camera and press [MENU].

2. On the "Set Up" tab, select "USB" and then press [▶].

3. Use [▲] and [▼] to select "Mass Storage", and then press [SET].

4. Turn off the camera and then use the USB cable that comes with the camera to connect it to your computer.

- The camera does not draw power over the USB cable. Make sure the camera's battery is sufficiently charged before connecting.
- Make sure that you insert the cable connector into the USB/AV port until you feel it click securely into place. Failure to insert the connector fully can result in poor communication or malfunction.
- Note that even while the connector is fully inserted, you still will be able to see the metal part of the connector as shown in the illustration.
- When connecting the USB cable to a USB port, make sure you align the connector correctly with the port.

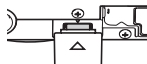
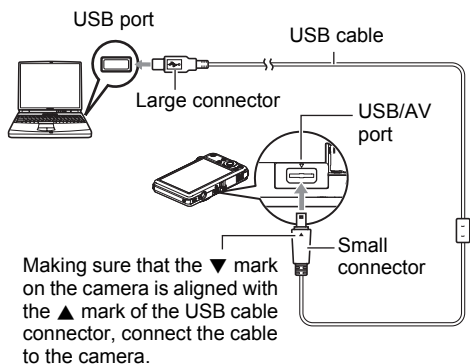

---

## 5. Turn on the camera.

---

## 6. Copy images to your computer.

### Windows XP

- ① Select "Open folder to view files" and then click "OK".
- ② Drag the "DCIM" folder to your Windows desktop to copy it.

### Windows Vista

- ① Select "Open folder to view files".
- ② Drag the "DCIM" folder to your Windows desktop to copy it.

### Windows 2000, Me, 98SE, 98

- ① Double-click "My Computer".
  - ② Double-click "Removable Disk".
  - ③ Drag the "DCIM" folder to your Windows desktop to copy it.
- 

## 7. After you finish copying images, disconnect the camera from the computer.

### Windows Vista, Windows XP, 98SE, 98

On the camera, press [ON/OFF] to turn off the camera. After making sure that the back lamp is unlit, disconnect the camera from the computer.

### Windows 2000/Me

Click card services in the task tray on your computer screen, and disable the drive number assigned to the camera. Next, after making sure that the back lamp is unlit, press the camera's [ON/OFF] button to turn off the camera and disconnect the camera from your computer.

## ■ To view images you copied to your computer

**1. Double-click the copied “DCIM” folder to open it.**

---

**2. Double-click the folder that contains the images you want to view.**

---

**3. Double-click the image file you want to view.**

- For information about file names, see “Memory Folder Structure” on page 115.
- An image that was rotated on the camera will be displayed on your computer screen in its original (unrotated) orientation.



### **IMPORTANT!**

- Never use your computer to modify, delete, move, or rename any image files that are in the camera’s built-in memory or on its memory card. Doing so can cause problems with the camera’s image management data, which will make it impossible to play back images on the camera and can drastically alter remaining memory capacity. Whenever you want to modify, delete, move, or rename an image, do so only on images that are stored on your computer.
- Never unplug the USB cable, or operate the camera while viewing or storing images. Doing so can cause data to become corrupted.

## Save images to a computer automatically/Manage images

---

Installing Photo Loader with HOT ALBUM on your computer makes it possible to transfer images from the camera to your computer automatically.

### ■ To install Photo Loader with HOT ALBUM

#### **1. Start up your computer, and place the bundled CD-ROM into its CD-ROM drive.**

Normally, this should cause the menu screen to appear automatically. If your computer does not display the menu screen automatically, navigate to the CD-ROM on your computer and then double-click the "AutoMenu.exe" file.

---

#### **2. Click "Photo Loader with HOT ALBUM 3.1" to select it and then click "Read me."**

The "Read me" file contains important information about installation, including installation conditions and computer system requirements.

---

#### **3. Click "Install" for Photo Loader with HOT ALBUM.**

---

#### **4. Follow the instructions that appear on the display to complete installation.**

### Checking Your Computer's DirectX Version

In order to manage images using Photo Loader with HOT ALBUM, your computer also needs to have Microsoft DirectX 9.0 or higher installed. Use the following procedure to check your computer's DirectX version.

#### **1. Click the following items on your computer to display System Tools: Start → All Programs → Accessories → System Tools.**

---

#### **2. On the System Tools "Tools" menu, select "DirectX Diagnostic Tool".**

On the "System" tab, check to make sure that the "DirectX Version" is 9.0 or higher.

---

#### **3. Click "Exit" to exit the DirectX Diagnostic Tool.**

- If your computer does not have Microsoft DirectX 9.0 or higher installed, install Microsoft DirectX 9.0c from the bundled CD-ROM.



## Playing Movies

---

You can play back movies on your computer if it has QuickTime 7 or higher installed. To play back a movie, first copy it to your computer and then double-click the movie file.



### ■ To install QuickTime 7

1. On the CD-ROM menu screen (page 104), select “QuickTime 7”.
2. After reading the information about installation conditions and system requirements for installation in the “Read me” file, install QuickTime 7.

### ■ Minimum Computer System Requirements for Movie Playback

Operating System : Vista / XP (SP2) / 2000 (SP4)

CPU : Pentium M, 1 GHz or higher Pentium 4, 2 GHz or higher

Required Software : QuickTime 7, DirectX 9.0c or higher

- The above are recommended system environments. Configuring one of these environments does not guarantee proper operation.
- Certain settings and other installed software may interfere with proper playback of movies.

## Uploading Movie Files to YouTube

---

Installing YouTube Uploader for CASIO from the CD-ROM that comes with your camera simplifies uploading of movie files you recorded with the “For YouTube” BEST SHOT scene to YouTube.

### ■ What is YouTube?

YouTube is a movie sharing site managed by YouTube, LLC where you can upload movies and view movies uploaded by others.

### ■ To install YouTube Uploader for CASIO

1. On the CD-ROM menu screen (page 104), select “YouTube Uploader for CASIO”.
2. After reading the information about installation conditions and system requirements for installation in the “Read me” file, install YouTube Uploader for CASIO.

## ■ To upload a movie file to YouTube

- Before you can use YouTube Uploader for CASIO, you need to go to the YouTube website (<http://www.youtube.com/>) and register as a user there.
- Do not upload any video that is copyrighted (including neighboring copyrights) unless you yourself own the copyright or you have obtained the permission of the applicable copyright holder(s).
- The maximum file size for each upload is 100 MB.

**1. Record the movie you want to upload using the “For YouTube” BEST SHOT movie scene.**

---

**2. If it isn’t already, connect your computer to the Internet.**

---

**3. Connect the camera to your computer (page 101).**

---

**4. Turn on the camera.**

YouTube Uploader for CASIO will start up automatically.

- If this is the first time you are using the application, configure the YouTube user ID and network environment settings, and then click the [OK] button.
- 

**5. The left side of the display will have an area for inputting a title, category, and other information required for uploading to YouTube. Enter the required information.**

---

**6. The right side of the display shows a list of movie files in camera memory. Select the check box next to the movie file you want to upload.**

---

**7. When everything is ready, click the [Upload] button.**

This will upload the movie file(s) to YouTube.

- After uploading is complete, click the [Exit] button to exit the application.

## Transferring Images from Your Computer to Camera Memory

---

If you want to transfer images from your computer to the camera, install Photo Transport on your computer from the CD-ROM that comes with the camera.

### ■ To install Photo Transport

1. On the CD-ROM menu screen (page 104), select “Photo Transport”.
2. After reading the information about installation conditions and system requirements for installation in the “Read me” file, install Photo Transport.

### ■ To transfer images to the camera

1. On your computer, click the following: Start → All Programs → Casio → Photo Transport.

This starts up Photo Transport.

2. Drag the file(s) you want to transfer to the [Transfer] button.
3. Follow the instructions that appear on the display to complete the transfer.
  - The details of the instructions that appear on the display and the transferred images will depend on your Photo Transport setup. For details, click the [Settings] button or [Help] button and check the setup.

### Transfer Data

- Only image files with the following extensions can be transferred to the camera: jpg, jpeg, jpe, bmp (bmp images are converted to jpeg image automatically when transferred.)
- Certain types of images may not be able to be transferred.
- You cannot transfer movies to the camera.

## ■ To transfer computer screen captures to the camera

**1. Connect the camera to your computer (page 101).**

---

**2. On your computer, click the following: Start → All Programs → Casio → Photo Transport.**

This starts up Photo Transport.

---

**3. Display the screen whose screen capture you want to transfer.**

---

**4. Click the [Capture] button.**

---

**5. Draw a boundary around the area you want to capture.**

Move your mouse pointer to the upper left corner of the area you want to capture and then hold down the mouse button. Keeping the mouse button depressed, drag the pointer down to the lower right corner of the area and then release the mouse button.

---

**6. Follow the instructions that appear on the display.**

This will send an image of the area you selected to the camera.

- The transfer operation converts screen captures to JPEG format.
  - The instructions that appear on the display and details about the transferred images will depend on your Photo Transport setup. For details, click the [Settings] button or [Help] button and check the setup.
- 

## ■ About settings and help

Click the [Settings] button when you want to change the Photo Transport setup. For help about operation procedures and troubleshooting, click the Photo Transport [Help] button.

## Viewing User Documentation (PDF Files)

---

**1. Start up your computer, and place the bundled CD-ROM into its CD-ROM drive.**

Normally, this should cause the menu screen to appear automatically. If your computer does not display the menu screen automatically, navigate to the CD-ROM on your computer and then double-click the "AutoMenu.exe" file.

---

**2. On the menu screen, click the "Language" down arrow button and then select the language you want.**

---

**3. Click "Manual" to select it and then click "Digital Camera".**

---



## **IMPORTANT!**

- You must have Adobe Reader or Adobe Acrobat Reader installed on your computer in order to view the contents of a PDF file. If you do not already have Adobe Reader or Adobe Acrobat Reader installed, install Adobe Reader from the bundled CD-ROM.

## **User Registration**

---

You can perform user registration over the Internet. To do so, of course, you need to be able to connect to the Internet with your computer.

### **1. On the CD-ROM menu screen (page 104), click the “Register” button.**

- This starts up your Web browser and accesses the user registration website. Follow the instructions that appear on your computer screen to register.

## Using the Camera with a Macintosh

Install the required software in accordance with what version of the Macintosh OS you are running and what you want to do.

When you want to do this:	Operating System Version	Install this software:	See page:
Save images to your Macintosh and view them there manually	Mac OS 9	Installation not required.	110
	Mac OS X		
Save images to your Macintosh automatically/ Manage images	Mac OS 9	Use commercially available software.	112
	Mac OS X	Use iPhoto, which comes bundled with your operating system.	
Play movies	Mac OS 9	Playback not supported.	113
	Mac OS X	Movie file playback is supported under OS X v10.3.9 or higher when QuickTime 7 or higher is installed.	113
Transfer document data to the camera	Mac OS X	<b>CASIO DATA TRANSPORT 1.0</b>	117

## Connecting the Camera to Your Computer and Saving Files



### IMPORTANT!

- The camera does not support operation with Mac OS 8.6 or earlier, or Mac OS X 10.0. Operation is supported with Mac OS 9, X (10.1, 10.2, 10.3, 10.4) only. Use the standard USB driver that comes with your supported operating system.

### ■ To connect the camera to your computer and save files

1. Turn on the camera and press [MENU].
2. On the “Set Up” tab, select “USB” and then press [▶].
3. Use [▲] and [▼] to select “Mass Storage”, and then press [SET].

---

**4. Turn off the camera and then use the USB cable that comes with the camera to connect it to your Macintosh.**

- The camera does not draw power over the USB cable. Make sure the camera's battery is sufficiently charged before connecting.
- Make sure that you insert the cable connector into the USB/AV port until you feel it click securely into place. Failure to insert the connector fully can result in poor communication or malfunction.
- Note that even while the connector is fully inserted, you still will be able to see the metal part of the connector as shown in the illustration.
- When connecting the USB cable to a USB port, make sure you align the connector correctly with the port.

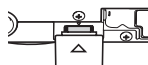
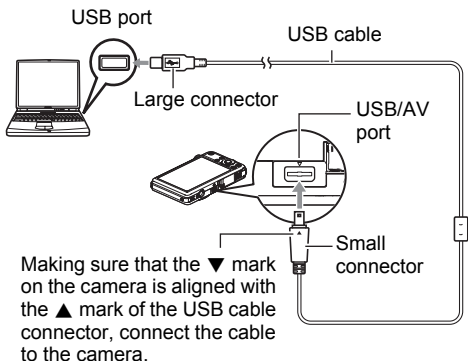

---

**5. Turn on the camera.**

The camera's back lamp will light green at this time. In this mode, your Macintosh recognizes the memory card loaded in the camera (or the camera's built-in memory if it does not have a memory card loaded) as a drive. The appearance of the drive icon depends on the Mac OS version you are using.

---

**6. Double-click the camera's drive icon.**

---

**7. Drag the "DCIM" folder to the folder to which you want to copy it.**

---

**8. After the copy operation is complete, drag the drive icon to Trash.**

---

**9. On the camera, press [ON/OFF] to turn off the camera. After making sure that the green back lamp is unlit, disconnect the camera from the computer.**

## ■ To view copied images

**1. Double-click the camera's drive icon.**

---

**2. Double-click the "DCIM" folder to open it.**

---

**3. Double-click the folder that contains the images you want to view.**

---

**4. Double-click the image file you want to view.**

- For information about file names, see "Memory Folder Structure" on page 115.
- An image that was rotated on the camera will be displayed on your Macintosh screen in its original (unrotated) orientation.



### **IMPORTANT!**

- Never use your computer to modify, delete, move, or rename any image files that are in the camera's built-in memory or on its memory card. Doing so can cause problems with the camera's image management data, which will make it impossible to play back images on the camera and can drastically alter remaining memory capacity. Whenever you want to modify, delete, move, or rename an image, do so only on images that are stored on your computer.
- Never unplug the USB cable, or operate the camera while viewing or storing images. Doing so can cause data to become corrupted.

## **Transferring Images Automatically and Managing Them on Your Macintosh**

---

If you are running Mac OS X, you can use the iPhoto application that comes bundled with the operating system to manage your images. If you are running Mac OS 9, you will need to use commercially available software.



## Playing a Movie

---

You can use QuickTime, which comes bundled with your operating system, to play back movies on a Macintosh. To play back a movie, first copy it to your Macintosh and then double-click the movie file.



### ■ Minimum System Requirements for Movie Playback

The minimum system requirements described below are necessary to play back movies recorded with this camera on a Macintosh.

Operating System : Mac OS X 10.3.9 or higher

QuickTime Version : QuickTime 7 or higher

- The above are recommended system environments. Configuring one of these environments does not guarantee proper operation.
- Even if your Macintosh meets the minimum requirements described above, certain settings and other installed software may interfere with proper playback of movies.
- Movie file playback is not supported under OS 9.

## Viewing User Documentation (PDF Files)

---

You must have Adobe Reader or Adobe Acrobat Reader installed on your computer in order to view the contents of a PDF file. If you don't, go to the Adobe Systems Incorporated website and install Acrobat Reader.

- 1. On the CD-ROM, open the “Manual” folder.**
- 2. Open the “Digital Camera” folder and then open the folder for the language whose user’s guide you want to view.**
- 3. Open the file named “camera\_xx.pdf”.**
  - “xx” is the language code (Example: camera\_e.pdf is for English.)

## User Registration

---

Internet registration only is supported. Visit the following CASIO website to register:  
<http://world.casio.com/qv/register/>

## Files and Folders

The camera creates a file and saves it each time you shoot a snapshot, record a movie, or perform any other operation that stores data. Files are grouped by storing them in folders. Each file and folder has its own unique name.

- For details about how folders are organized in memory, see “Memory Folder Structure” (page 115).

Name and Maximum Number Allowed	Example
<b>File</b>	
Each folder can contain up to 9999 files named CIMG0001 through CIMG9999. The extension on the file name depends on the file type.	26th file name:  CIMG0026.JPG               Serial number (4 digits) Extension
<b>Folders</b>	
Folders are named from 100CASIO to 999CASIO There can be up to 900 folders in memory. <ul style="list-style-type: none"><li>• The BEST SHOT mode (page 50) includes a sample scene that optimizes settings for auction site images. Depending on your camera model, the sample scene is named either “For eBay” or “Auction”.<ul style="list-style-type: none"><li>– Images recorded with the eBay scene are stored in a folder named “100_EBAY”.</li><li>– Images recorded with the Auction scene are stored in a folder named “100_AUCT”.</li></ul></li><li>• BEST SHOT also has a scene named “For YouTube” that optimizes movie settings for recording movies for upload to YouTube. Images recorded with the YouTube scene are stored in a folder named “100YOUTB”.</li></ul>	100th folder name:  100CASIO  Serial number (3 digits)

- You can view folder and file names on your computer. For details about how file names are displayed on the camera’s monitor screen, see page 151.
- The total number of folders and files allowed depends on the image size and quality, and capacity of the memory card being used for storage.

## Memory Card Data

The camera stores images you shoot in accordance with the Design Rule for Camera File System (DCF).

### ■ About DCF

DCF is a standard that makes it possible to view and print images recorded on one manufacturer's camera on DCF-compliant devices produced by other manufacturers. You can transfer DCF-compliant images recorded with another camera to this camera and view them on this camera's monitor screen.

### ■ Memory Folder Structure

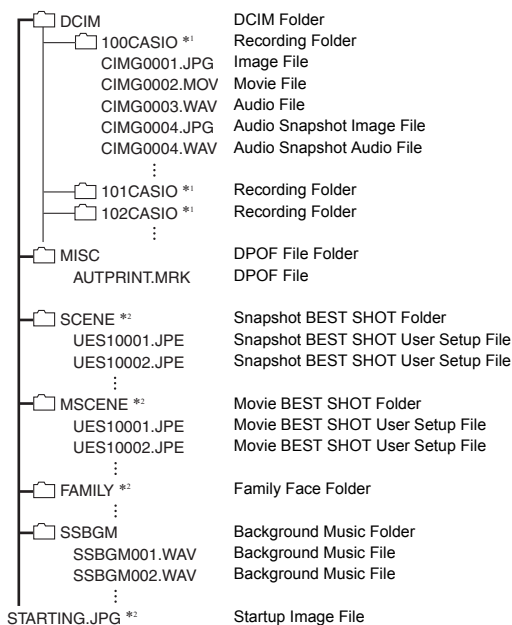

\*1 Other folders are created when the following BEST SHOT scenes are used for recording: "For eBay" or "Auction" (scene name depends on camera model), or "For YouTube". The following shows the name of the folder created for each scene.

- eBay scene: 100\_EBAY
- Auction scene: 100\_AUCT
- YouTube scene: 100YOUTB

\*2 This folder can be created in built-in memory only.

## ■ Supported Image Files

- Image files shot with this camera
- DCF-compliant image files

This camera may not be able to display an image, even if it is DCF-compliant. When displaying an image recorded on another camera, it may take a long time for the image to appear on this camera's monitor screen.

## ■ Built-in Memory and Memory Card Data Handling Precautions

- Whenever copying memory contents to your computer, you should copy the DCIM folder and all of its contents. A good way to keep track of multiple DCIM copies of the DCIM folders is to change its name to a date or something similar after you copy it to your computer. If you later decided to return the folder to the camera, however, be sure to change its name back to DCIM. The camera is designed to recognize only a root file with the name DCIM. Note the camera also will not be able to recognize the folders inside the DCIM folder unless they have the names they originally had when you copied them from the camera to your computer.
- Folders and files must be stored in accordance with the "Memory Folder Structure" shown on page 115 in order for the camera to be able to recognize them correctly.
- You also can use a PC card adapter or a memory card reader/writer to access camera files directly from the camera's memory card.

# Transferring Document Data from Your Computer to the Camera

You can use CASIO DATA TRANSPORT to transfer images of documents, digital books, web page images, and other document data you can view on your computer screen to the camera. Then you will be able to view the documents on the camera's monitor screen.

- Just about any document you can print from your computer can be transferred to the camera. Note, however, the ability to properly transfer and display any particular type of data is not guaranteed.
- Images of certain types of data may appear differently on the camera from the way they appear on your computer screen.

## Transferring Document Data to the Camera

To transfer document data on your computer to the camera so you can view it on the monitor screen, you need to install the CASIO DATA TRANSPORT application from the CD-ROM that comes with the camera.

### Transferring Data from a Computer Running Windows

#### ■ To install CASIO DATA TRANSPORT

1. On the CD-ROM menu screen (page 104), select "DATA TRANSPORT".
2. After reading the information about installation conditions and system requirements for installation in the "Read me" file, install CASIO DATA TRANSPORT.

#### ■ To transfer document data to the camera

1. Connect the camera to your computer (page 101).
  - Before connecting the camera to your computer, make sure that a memory card is loaded in the camera (page 146).
2. On your computer, open the document data that you want to transfer to the camera.
3. On the menu bar of the application you used to open the document data, select "File" → "Print" to display the print dialog box. Click the "Printer Name" down arrow button and then select "CASIO DATA TRANSPORT" from the list that appears.

---

**4. Click the [OK] button.**

- This will display a dialog box for configuring data settings.

---

**5. Check the current data settings (date, file name, icon) and then click [OK].**

This will convert the document data to a JPEG image and transfer the image to the camera.

- You can change the date, filename, and icon settings if you want.
- If you want a document image be displayed on the camera's monitor screen using an orientation that is different from that used on the computer screen, click the [Properties] button on the print dialog box, and then change the "Orientation" setting.

---

**Transferring Data from a Macintosh**

---

Before installing CASIO DATA TRANSPORT be sure to read any "readme" file that accompanies it. "readme" files contain important information about installation, including installation conditions and computer system requirements.

**■ To install CASIO DATA TRANSPORT****1. Place the CD-ROM that comes bundled with the camera into your Macintosh CD-ROM drive.**

---

**2. Open the folder named "DATA TRANSPORT".**

---

**3. Double-click "TRANSPORT\_Installer".**

---

**4. Follow the instructions that appear on your screen to install the software.**

## ■ To transfer document data to the camera

### 1. Connect the camera to your Macintosh (page 110).

- Before connecting the camera to your Macintosh, make sure that a memory card is loaded in the camera (page 146).

---

### 2. On your Macintosh, open the document data that you want to transfer to the camera.

---

### 3. On the Macintosh menu bar, click “File” → “Print” to display the print dialog box.

---

### 4. Click the [PDF] button and select “CASIO DATA TRANSPORT” from the list that appears.

This will display a dialog box for configuring data settings.

---

### 5. Check the current data settings (date, file name, icon) and then click [OK].

This will convert the document data to a JPEG image and transfer the image to the camera.

- You can change the date, filename, and icon settings if you want.

## To view document images on the camera

### 1. In the PLAY mode, press [BS] (🔒).

This enters the data mode and displays a menu of document images currently in camera memory.

- Pressing [BS] (🔒) again will return to the PLAY mode.

---

### 2. Use the [▲], [▼], [◀], and [▶] to move the selection boundary to the document image you want to select, and then press [SET].

This will display the image of the document you selected.

---

### 3. View the document pages.

[◀][▶]	Scroll between pages
[SET]	Toggles between the document menu screen and document page





- All the pages of document data on a memory card will be printed if you use the card to transfer image data to a printer or a professional print service (page 95).

## ■ To zoom a document page

**1. Display the page of the document you want to zoom.**

---

**2. Slide the zoom controller towards  to enlarge.**

You can use , , , and  to scroll the zoomed image on the monitor screen. Slide the zoom controller towards  to unzoom the image.

- If display indicators are turned on, an indicator in the lower right corner of the monitor screen shows what part of the zoomed image is currently displayed.
- To exit the zoom screen, press [MENU] or [BS] ().
- Though the maximum image zoom factor is 8X, certain image sizes may not allow zooming up to the full 8X.

## ■ To rotate a document page

**1. Display any page in the document that contains the page you want to rotate and then press [MENU].**

---

**2. On the “DATA” tab, select “Rotation”, and then press .**

---

**3. Use  and  to select “Rotate”, and then press [SET].**

Each press of [SET] will rotate the displayed image 90 degrees left.

---

**4. When the displayed image is at the orientation you want, press [MENU].**



## ■ To specify the initial data mode screen

1. Display the page of the document and then press [MENU].
2. On the “Set Up” tab, select “DATA View”, and then press [▶].
3. Use [▲] and [▼] to select the setting you want, and then press [SET].

Page View	Displays the last document page viewed
List View	Displays the document image menu

## Managing Document Data on the Camera

### Protecting Document Data

You can protect a specific document or all documents against deletion.

1. Display any page in the document that contains the page you want to protect and then press [MENU].
2. On the “DATA” tab, select “Protect”, and then press [▶].

You also can use the same procedure as above in the PLAY mode to protect a document (page 86).

### Deleting Document Data

#### ■ To delete a document page

1. Display any page in the document that contains the page you want to delete and then press [▼] (  ).
2. Use [◀] and [▶] to select the page you want to delete.
3. Use [▲] and [▼] to select “1 page” and then press [SET].  
To delete all of the pages in the document, select “All pages”.
4. To delete other pages in the document, repeat steps 2 and 3.
  - To exit the delete operation, press [MENU].

## ■ Deleting a Document

You can delete a single document or you can batch delete all of the documents.

- Formatting camera memory (page 132) also will delete all contents on the memory card or in built-in memory.

### To delete a single document

**1.** On the document menu, use [▲], [▼], [◀], and [▶] to move the selection boundary to the document you want to delete.

---

**2.** Press [MENU].

---

**3.** Use [▲] and [▼] to select “1 doc” and then press [SET].

---

**4.** In response to the confirmation message that appears, use [▲] and [▼] to select “Yes”, and then press [SET].

### To delete all documents

**1.** While the document menu is displayed, press [MENU].

---

**2.** Use [▲] and [▼] to select “All docs” and then press [SET].

---

**3.** In response to the confirmation message that appears, use [▲] and [▼] to select “Yes”, and then press [SET].

## Other Settings (Set Up)

This section explains menu items that you can use to configure settings and perform other operations in both the REC mode and PLAY mode.



For information about menu operations, see page 56.

### Selecting a REC Mode Screen Layout ( Panel)

#### Procedure

[MENU] → Set Up Tab →  Panel

The REC mode screen layout settings let you select the layout of icons.

<b>On</b>	Displays the Control Panel. The Control Panel makes it quick and easy to change certain camera settings.	 The image shows a camera viewfinder with a landscape scene. A semi-transparent Control Panel is overlaid on the right side of the image, containing various camera settings icons and text such as '62', 'OFF', 'ISO', '+1.0EV', and '12:38'.
<b>Off</b>	Turns off Control Panel display. This setting helps to view more of the image when the 16:9 aspect ratio is selected. Certain camera settings are indicated by icons on the image.	 The image shows the same camera viewfinder with the landscape scene, but the Control Panel overlay is absent. Instead, camera settings are indicated by small icons directly on the image, including '62', 'OFF', 'ISO', '+1.0', '08/12/24', and '12:38'.



- All screen shots in this manual show what appears when the Control Panel is turned on.

## Selecting a PLAY Mode Screen Layout ( Display)

### Procedure

[MENU] → Set Up Tab →  Display

The PLAY mode screen layout settings let you select how display images are shown on the monitor screen.

<b>Wide</b>	With this setting, the display image is the maximum possible size that allows the entire image to be displayed horizontally. With some aspect ratios, the top and bottom of the image will be cut off.	
<b>4:3</b>	100% of the display image is always visible. With some aspect ratios, black bands may appear above and below, or to the left and right of the image.	

## Adjusting Monitor Screen Brightness (Screen)

### Procedure

[MENU] → Set Up Tab → Screen



You can change the brightness of the monitor screen.

<b>Auto 1 or Auto 2</b>	With this setting, the camera detects available light levels and automatically adjusts the brightness of the monitor screen accordingly. <ul style="list-style-type: none"><li>• Auto 2 adjusts to a brighter setting more quickly than Auto 1.</li></ul>
<b>+2</b>	Brightness that is greater than +1, which makes the screen easier to view. This setting consumes more power.
<b>+1</b>	Bright setting for outdoor use, etc. Brightness that is greater than 0.
<b>0</b>	Normal monitor screen brightness for indoor use, etc.

## Configuring Camera Sound Settings (Sounds)

### Procedure

[MENU] → Set Up Tab → Sounds

<b>Startup</b>	
<b>Half Shutter</b>	Specifies the startup sound
<b>Shutter</b>	Sound 1 - 5: Built-in sounds (1 through 5) Off: Sound off
<b>Operation</b>	
<b>Operation (  )</b>	Specifies the sound volume. This setting is also used as the audio level during video output (page 75).
<b>Play (  )</b>	Specifies the volume of movie and Audio Snapshot audio output. This volume setting is not used during video output (from the USB/AV port).

- Setting a volume level of 0 mutes output.

## Configuring a Startup Image (Startup)

### Procedure

[MENU] → Set Up Tab → Startup

Display the image you want to use as your startup image and then select “On”.

- The startup image does not appear when you turn on the camera by pressing [  ] (PLAY).
- You can specify a snapshot you recorded as the startup image, or you can use the special startup image provided in the camera’s built-in memory.
- If you select an audio snapshot as the startup image, the audio will not play at startup.
- Formatting built-in memory (page 132) will delete the current startup image setting.

## Specifying the File Name Serial Number Generation Rule (File No.)

### Procedure

[MENU] → Set Up Tab → File No.

Use the following procedure to specify the rule that governs generation of the serial number used in file names (page 114).

<b>Continue</b>	Tells the camera to remember the last used file number. A new file will be named using the next sequential number, even if files are deleted or if a blank memory card is loaded. If a memory card is loaded and that card already has files stored on it and the largest sequential number in the existing file names is greater than the largest sequential number remembered by the camera, numbering of new files will start from the largest sequential number in the existing file names plus 1.
<b>Reset</b>	Restarts the serial number from 0001 whenever all files are deleted or when the memory card is replaced with a blank one. If a memory card is loaded and that card already has files stored on it, numbering of new files will start from the largest sequential number in the existing file names number plus 1.

## Configuring World Time Settings (World Time)

### Procedure

#### [MENU] → Set Up Tab → World Time

You can use the World Time screen to view the current time in a zone that is different from your Home City when you go on a trip, etc. World Time displays the current time in 162 cities in 32 time zones around the globe.

1. Use [▲] and [▼] to select “World” and then press [▶].
  - To change the geographic area and city for the time where you normally use the camera, select “Home”.
2. Use [▲] and [▼] to select “City” and then press [▶].
  - To change the “World” setting to summer time, use [▲] and [▼] to select “DST” and then select “On”. Summer time is used in some geographical areas to advance the current time setting by one hour during the summer months.
3. Use [▲], [▼], [◀], and [▶] to select the geographic area you want and then press [SET].
4. Use [▲] and [▼] to select the city you want and then press [SET].
5. Press [SET].

## Time Stamping Snapshots (Timestamp)

### Procedure

#### [MENU] → Set Up Tab → Timestamp

You can configure the camera to stamp the recording date only, or date and time in the lower right corner of each snapshot.

- Once date and time information is stamped into a snapshot, it cannot be edited or deleted.

Example: December 19, 2009, 1:25 p.m.

Date	2009/12/19
Date&Time	2009/12/19 1:25pm
Off	No stamping of date and/or time

- Even if you do not stamp the date and/or time with Timestamp, you can do so later using the DPOF function or some printing application (page 96).
- Digital zoom is disabled while date stamping is turned on.
- Date stamping is not possible for the following types of images.
  - Images recorded with certain BEST SHOT scenes (Business cards and documents, White board, etc.)

## Setting the Camera's Clock (Adjust)

### Procedure

[MENU] → Set Up Tab → Adjust

[▲] [▼]	Change the setting at the cursor location
[◀] [▶]	Move the cursor between settings
[BS] (🔒)	Toggles between 12-hour and 24-hour format

When the date and time settings are what you want, press [SET] to apply them.

- You can specify a date from 1980 to 2049.
- Be sure to select your Home City (page 127) before setting the time and date. If you set the time and date while the wrong city is selected for your Home City, the times and dates of all of the World Time cities (page 127) will be wrong.

## Specifying the Date Style (Date Style)

### Procedure

[MENU] → Set Up Tab → Date Style

You can select from among three different styles for the date.

Example: December 19, 2009

<b>YY/MM/DD</b>	09/12/19
<b>DD/MM/YY</b>	19/12/09
<b>MM/DD/YY</b>	12/19/09

- This setting also affects the Control Panel date format as shown below (page 23).  
YY/MM/DD or MM/DD/YY: MM/DD  
DD/MM/YY: DD/MM



## Specifying the Display Language (Language)

### Procedure

[MENU] → Set Up Tab → Language

Specify the display language you want.

- ① Select the tab on the right.
- ② Select "Language".
- ③ Select the language you want.



## Specifying the Initial Data Mode Screen (DATA View)

### Procedure

[MENU] → Set Up Tab → DATA View

See page 121 for details.

## Configuring Sleep State Settings (Sleep)

### Procedure

[MENU] → Set Up Tab → Sleep

This feature turns off the monitor screen whenever no camera operation is performed for a preset amount of time. Press any button to turn the monitor screen back on.

Trigger Time Settings: 30 sec, 1 min, 2 min, Off (Sleep is disabled while "Off" is selected.)

Sleep is disabled under any of the following conditions.

- In the PLAY Mode
- While the camera is connected to a computer or other device
- During a slideshow
- During Auto Shutter standby
- During Voice Recording playback or recording
- During movie recording and playback
- When both sleep and Auto Power Off are turned on, Auto Power Off takes priority.

## Configuring Auto Power Settings (Auto Power Off)

### Procedure

#### [MENU] → Set Up Tab → Auto Power Off

Auto Power Off turns off the camera whenever no camera operation is performed for a preset amount of time.

Trigger Time Settings: 1 min, 2 min, 5 min (The trigger time is always 5 minutes in the PLAY mode.)

Auto Power Off is disabled under any of the following conditions.

- While the camera is connected to a computer or other device
- During a slideshow
- During Voice Recording playback or recording
- During movie recording and playback

## Configuring [📷] and [▶] Settings (REC/PLAY)

### Procedure

#### [MENU] → Set Up Tab → REC/PLAY

<b>Power On</b>	Camera turns on whenever [📷] (REC) or [▶] (PLAY) is pressed.
<b>Power On/Off</b>	Camera turns on or off whenever [📷] (REC) or [▶] (PLAY) is pressed.
<b>Disable</b>	Camera does not turn on or off whenever [📷] (REC) or [▶] (PLAY) is pressed.

- With “Power On/Off”, the camera turns off when you press [📷] (REC) in the REC mode or [▶] (PLAY) in the PLAY mode.
- Change this setting to anything besides “Disable” before connecting to a TV for image viewing.

## Configuring USB Protocol Settings (USB)

### Procedure

#### [MENU] → Set Up Tab → USB

You can use the procedure below to select the USB communication protocol, which is used when exchanging data with a computer, printer, or other external device.

<b>Mass Storage</b>	Select this setting when connecting to a computer or other device that supports USB DIRECT-PRINT (page 93). With this setting, the computer sees the camera as an external storage device. Use this setting for normal transfer of images from the camera to a computer (using the bundled Photo Loader with HOT ALBUM application).
<b>PTP (PictBridge)</b>	Select this setting when connecting to a printer that supports PictBridge (page 93). This setting simplifies the transfer of image data to the connected device.

## Selecting the Screen Aspect Ratio and Video Output System (Video Out)

### Procedure

#### [MENU] → Set Up Tab → Video Out

You can use the procedure in this section to select either NTSC or PAL as the video output system. You can also specify an aspect ratio of 4:3 or 16:9.

<b>NTSC</b>	Video system used in Japan, the U.S., and other countries
<b>PAL</b>	Video system used in Europe and other areas
<b>4:3</b>	Normal TV screen aspect ratio
<b>16:9</b>	Wide screen aspect ratio

- Select the aspect ratio (4:3 or 16:9) that matches the type of TV you plan to use. Images will not display correctly if you select the wrong aspect ratio.
- Images will not display correctly unless the camera's video signal output setting matches the video signal system of the TV or other video equipment.
- Images cannot be displayed correctly on a TV or video equipment that is not NTSC or PAL.

## Formatting Built-in Memory or a Memory Card (Format)

### Procedure

#### [MENU] → Set Up Tab → Format

If a memory card is loaded in the camera, this operation will format the memory card. It will format built-in memory if no memory card is loaded.

- The format operation will delete all contents on the memory card or in built-in memory. It cannot be undone. Make sure you do not need any data currently on the card or in built-in memory before you format it.
- Formatting built-in memory will delete the following data.
  - Pre-recorded face data for face recognition
  - Protected images
  - BEST SHOT mode user setups
  - Startup screen
- Formatting a memory card will delete the following data.
  - Protected images
- Make sure that the battery is charged fully before starting a formatting operation. Formatting may not be performed correctly and the camera may stop operating normally if the camera powers down while formatting is in progress.
- Never open the battery cover while formatting is in progress. Doing so can cause the camera to stop operating normally.

## Resetting the Camera to Factory Defaults (Reset)

### Procedure

#### [MENU] → Set Up Tab → Reset

See page 152 for details about the camera's factory default settings.

The settings below are not reset.

World Time settings, clock settings, date style, screen language, video output

# Configuring Monitor Screen Settings

You can turn display information on and off by pressing [▲] (DISP). You can configure separate settings for the REC mode and PLAY mode.

<b>Show</b>	Displays information about image settings, etc.
<b>+Histogram</b>	Turns on display of camera setting and other indicators, along with a histogram (page 134)  Histogram
<b>Hide</b>	No information displayed

## Using the On-screen Histogram to Check Exposure (+Histogram)

Displays a histogram on the monitor screen which you can use to check the exposure of an image before you shoot it. You also can display the histogram in the PLAY mode for information about the exposure levels of images.

- You can use key customization (page 64) to configure the [◀] and [▶] buttons so they control the EV shift setting (page 41), and perform EV shift while viewing the results on the on-screen histogram.



Histogram

### NOTE

- A centered histogram does not necessarily guarantee optimum exposure. The recorded image may be over-exposed or under-exposed, even though its histogram is centered.
- Due to the limitations of exposure compensation, you may not be able to achieve an optimum histogram configuration.
- Use of the flash and certain shooting conditions can cause the histogram to indicate exposure that is different from the actual exposure of the image when it is shot.

## How to Use the Histogram

A histogram is a graph that represents the lightness of an image in terms of the number of pixels. The vertical axis indicates the number of pixels, while the horizontal axis indicates lightness. If the histogram appears too lopsided for some reason, you can use EV shift to move it left or right in order to achieve better balance. Optimum exposure can be achieved by EV shifting so the graph is as close to the center as possible. For snapshots, you can even display individual histograms for R (red), G (green), and B (blue).

### Example Histograms

A histogram towards the left side results when the overall image is dark. A histogram that is too far to the left may result in “black out” of the dark areas of an image.



A histogram towards the right side results when the overall image is light. A histogram that is too far to the right may result in “white out” of the light areas of an image.



An overall well-balanced histogram results when the overall image is at optimal lightness.



## Precautions during Use

### ■ Avoid Use While In Motion

- Never use the camera to record or play back images while operating an automobile or other vehicle, or while walking. Looking at the monitor while in motion creates the risk of serious accident.

### ■ Directly Viewing the Sun or Bright Light

- Never look at the sun or any other bright light through the camera's viewfinder. Doing so can damage your eyesight.

### ■ Flash

- Never use the flash unit in areas where flammable or explosive gas may be present. Such conditions create the risk of fire and explosion.
- Never fire the flash in the direction of a person operating a motor vehicle. Doing so can interfere with the driver's vision and create the risk of accident.
- Never fire the flash too close to the eyes of the subject. Doing so creates the risk of loss of eyesight.

### ■ Monitor Screen

- The monitor screen of the camera uses reinforced glass. However, you still need to exercise caution against subjecting it to strong impact. Should the monitor screen glass crack, do not touch the broken part with your hand. Doing so creates the risk of personal injury.
- Be sure to put the camera into the optional soft case whenever carrying it in your pocket, bag, etc. to keep the monitor screen from coming into contact with other objects.
- Should the monitor screen ever become cracked, never touch any of the liquid inside the monitor screen. Doing so creates the risk of skin inflammation.
- Should monitor screen liquid ever get into your mouth, immediately rinse your mouth out and contact your physician.
- Should monitor screen liquid ever get into your eyes or onto your skin, immediately rinse with clean water for at least 15 minutes and contact your physician.

### ■ Connections

- Never plug any devices that are not specified for use with this camera into connectors. Connecting a non-specified device creates the risk of fire and electric shock.

### ■ Transport

- Never operate the camera inside of an aircraft or anywhere else where operation of such devices is restricted. Improper use creates the risk of serious accident.

### ■ **Smoke, abnormal odor, overheating, and other abnormalities**

- Continued use of the camera while it is emitting smoke or strange odor, or while it is overheating creates the risk of fire and electric shock. Immediately perform the following steps whenever any of the above symptoms are present.
  1. Turn off the camera.
  2. Remove the battery from the camera, taking care to protect yourself against burn injury.
  3. Contact your dealer or nearest CASIO authorized service center.

### ■ **Water and Foreign Matter**

- Water, other liquids, or foreign matter (especially metal) getting inside the camera creates the risk of fire and electric shock. Immediately perform the following steps whenever any of the above symptoms are present. Particular care is required when using the camera where it is raining or snowing, near the ocean or other body of water, or in a bathroom.
  1. Turn off the camera.
  2. Remove the battery from the camera.
  3. Contact your dealer or nearest CASIO authorized service center.

### ■ **Dropping and Rough Treatment**

- Continued use of the camera after it is damaged by dropping or other rough treatment creates the risk of fire and electric shock. Immediately perform the following steps whenever any of the above symptoms are present.
  1. Turn off the camera.
  2. Remove the battery from the camera.
  3. Contact your dealer or nearest CASIO authorized service center.

### ■ **Keep Away From Fire**

- Never expose the camera to fire, which can cause it to explode and creates the risk of fire and electric shock.

### ■ **Disassembly and Modification**

- Never try to take the camera apart or modify it in any way. Doing so creates the risk of electric shock, burn injury, and other personal injury. Be sure to leave all internal inspection, maintenance, and repair up to your dealer or nearest CASIO authorized service center.



## ■ Locations To Be Avoided

- Never leave the camera in any of the following types of locations. Doing so creates the risk of fire and electric shock.
  - Areas subject to large amounts of humidity or dust
  - Food preparation areas or other locations where oil smoke is present
  - Near heaters, on a heated carpet, in areas exposed to direct sunlight, in a closed vehicle parked in the sun, or other areas subject to very high temperatures
- Never place the camera on an unstable surface, on a high shelf, etc. Doing so can cause the camera to fall, creating the risk of personal injury.

## ■ Backing Up Important Data

- Always keep backup copies of important data in camera memory by transferring it to a computer or other storage device. Note that data can be deleted in the case of camera malfunction, repair, etc.

## ■ Memory Protection

- Whenever replacing the battery, be sure to follow the correct procedure as described in the documentation that comes with the camera. Incorrectly replacing the battery can result in corruption or loss of data in camera memory.

## ■ Rechargeable Battery

- Use only the specified charger unit or the specified device to charge the battery. Attempting to charge the battery by an unauthorized means creates the risk of battery overheating, fire, and explosion.
- Do not expose or immerse the battery in fresh water or salt water. Doing so can damage the battery, and cause deterioration of its performance and loss of service life.
- The battery is intended for use with a CASIO Digital Camera only. Use with any other device creates the risk of the battery damage, or deterioration of battery performance and service life.
- Failure to observe any of the following precautions creates the risk of battery overheating, fire, and explosion.
  - Never use or leave the battery near open flame.
  - Do not expose the battery to heat or fire.
  - Make sure the battery is oriented correctly when it is connected to the charger unit.
  - Never carry or store the battery together with items that can conduct electricity (necklaces, pencil lead, etc.)
  - Never disassemble the battery, pierce it with a needle, or expose it to strong impact (hit it with a hammer, step on it, etc.), and never apply solder to it. Never place the battery into a microwave oven, heater, high-pressure generating device, etc.

- Should you ever notice leakage, strange odor, heat generation, discoloration, deformation, or any other abnormal condition while using, charging, or storing a battery, immediately remove it from the camera or charger unit and keep it away from open flame.
- Do not use or leave the battery under direct sunlight, in an automobile parked in the sun, or in any other area subject to high temperatures. Doing so can damage the battery, and cause deterioration of its performance and loss of service life.
- If battery charging does not end normally within the specified charging time, stop charging anyway and contact your local CASIO authorized service center. Continued charging creates the risk of battery overheating, fire, and explosion.
- Battery fluid can damage your eyes. Should battery fluid get into your eyes accidentally, immediately rinse them with clean tap water and then consult a physician.
- Be sure to read the user documentation that comes with the camera and special charger unit before using or charging the battery.
- If a battery is to be used by young children, make sure that a responsible adult makes them aware of the precautions and proper handling instructions, and make sure that they handle the battery correctly.
- Should fluid from a battery accidentally get onto clothing or your skin, immediately rinse it off with clean tap water. Prolonged contact with battery fluid can cause skin irritation.

## ■ Battery Life

- Battery continuous operation times provided in this manual represent the approximate amount of time before the camera turns off due to low battery power when being powered by the special battery under normal temperature (23°C (73°F)). They do not guarantee that you will be able to achieve the indicated level of operation. Actual battery life is greatly affected by ambient temperature, battery storage conditions, the amount of time spent in storage, etc.
- Leaving the camera on can run down the battery and cause the low battery warning to appear. Turn off the camera whenever you are not using it.
- The low battery warning indicates that the camera is about to turn off due to low battery power. Charge the battery as soon as possible. Leaving a low or dead battery in the camera can lead to battery leakage and data corruption.

## ■ Power Supply

- Use only the special rechargeable lithium ion battery (NP-60) to power this camera. Use of any other type of battery is not supported.
- The camera does not have a separate battery for the clock. The date and time settings of the camera are cleared about two days after power is cut off from the battery. If this happens, be sure to reconfigure these settings after power is restored (page 128).

## ■ Data Error Precautions

Your digital camera is manufactured using precision digital components. Any of the following creates the risk of corruption of data in camera memory.

- Removing the battery or memory card while the camera is performing some operation
- Removing the battery or memory card while the back lamp is flashing green after turning off the camera
- Disconnecting the USB cable while communication is in progress
- Using a battery that is low
- Other abnormal operations

Any of the above conditions can cause an error message to appear on the monitor screen (page 159). Perform the action indicated by the message that appears.

## ■ Operating Environment

- Operating Temperature: 0 to 40°C (32 to 104°F)
- Operating Humidity: 10 to 85% (non condensation)
- Do not place the camera in any of the following locations.
  - In an area exposed to direct sunlight, or large amounts of moisture or dust
  - Near an air conditioner or in other areas subjected to extreme temperature or humidity
  - Inside of a motor vehicle on a hot day, or in an area subjected to strong vibration

## ■ Condensation

Sudden and extreme temperature changes, such as when the camera is moved from the outdoors on a cold winter day into a warm room, can cause water droplets called “condensation” to form on the interior and the exterior of the camera, which creates the risk of malfunction. To prevent condensation from forming seal the camera in a plastic bag before changing locations. Then leave the bag sealed to allow the air inside to naturally change to the same temperature as the air in the new location. After that, remove the camera from the bag and open the battery cover for a few hours.

## ■ Lens

- Never apply too much force when cleaning the surface of the lens. Doing so can scratch the lens surface and cause malfunction.
- You may sometimes notice some distortion in certain types of images, such as a slight bend in lines that should be straight. This is due to the characteristics of lenses, and does not indicate malfunction of the camera.

## ■ Caring for your camera

- Never touch the lens or flash window with your fingers. Finger smudges, dirt, and other foreign matter on the lens or flash window can interfere with proper operation of the camera. Use a blower or other means to keep the lens and flash window free of dirt and dust, and wipe gently with a soft, dry cloth.
- To clean the camera, wipe it with a soft, dry cloth.
- The monitor screen of the camera uses reinforced glass, which can make smudges, fingerprints, dust, and other soiling more noticeable. Use a blower or other means to keep the monitor screen free of dirt and dust, and wipe with a soft, dry cloth to clean it.

## ■ Old Rechargeable Battery Handling Precautions

- Insulate the positive and negative terminals with tape, etc.
- Do not peel the covering off of the battery.
- Do not try to take the battery apart.

## ■ Charger Unit Handling Precautions



- Never plug the power cord into an outlet whose voltage rating is different from that marked on the power cord. Doing so creates the risk of fire, malfunction, and electric shock.
  - Take care to protect the power cord against damage and breaking. Never place heavy objects onto the power cord, or expose it to intense heat. Doing so can damage the power cord, creating the risk of fire and electric shock.
  - Never try to modify the power cord, or subject it to severe bending, twisting, or pulling. Doing so creates the risk of fire, malfunction, and electric shock.
  - Never plug in or unplug the power cord while your hands are wet. Doing so creates the risk of electric shock.
  - Do not plug the power cord into an outlet or extension cord that is shared by other devices. Doing so creates the risk of fire, malfunction, and electric shock.
  - Should the power cord ever become damaged (to the point that internal wires are exposed or cut), immediately contact your original retailer or authorized CASIO authorized service center to request repair. Continued use of a damaged power cord creates the risk of fire, malfunction, and electric shock.
- The charger unit becomes slightly warm during charging. This is normal and does not indicate malfunction.
  - Unplug the power cord from the power outlet when you are not using the charger unit.
  - Never use detergent to clean the power cord (especially the plug).
  - Never cover the charger unit with a blanket, etc. Doing so creates the risk of fire.

## ■ Other Precautions

The camera becomes slightly warm during use. This is normal and does not indicate malfunction.

## ■ Copyrights

Except for your own personal enjoyment, unauthorized use of use of snapshots or movies of images whose rights belong to others, without the permission of the right holder, is forbidden by copyright laws. In some cases, shooting of public performances, shows, exhibitions, etc. may be restricted entirely, even if it is for your own personal enjoyment. Regardless of whether such files are purchased by you or obtained for free, posting them on a website, a file sharing site, or any other Internet site, or otherwise distributing them to third parties without the permission of the copyright holder is strictly prohibited by copyright laws and international treaties. For example, uploading or distributing on the Internet images of TV programs, live concerts, music videos, etc. that were photographed or recorded by you may infringe upon the rights of others. Note that CASIO COMPUTER CO., LTD. shall not be held liable for use of this product in any way that infringes on the copyrights of others or that violates copyright laws.

The following terms, which are used in this manual, are registered trademarks or trademarks of their respective owners.

Note that trademark <sup>™</sup> and registered trademark <sup>®</sup> are not use within the text of this manual.

- The SDHC logo is a trademark.
- Microsoft, Windows, Internet Explorer, Windows Media, Windows Vista, and DirectX are registered trademarks or trademarks of Microsoft Corporation in the United States and other countries.
- Macintosh, Mac OS, QuickTime, the QuickTime logo, and iPhoto are trademarks of Apple Inc.
- MultiMediaCard is a trademark of Infineon Technologies AG of Germany, and licensed to the MultiMediaCard Association (MMCA).
- MMC*plus* is a trademark of the MultiMediaCard Association.
- Adobe and Reader are trademarks or registered trademarks in the United States and other countries of Adobe Systems Incorporated.
- HOT ALBUM and the HOT ALBUM logo are registered trademarks or trademarks of Konica Minolta Photo Imaging, Inc.
- YouTube, the YouTube logo, and "Broadcast Yourself" are trademarks or registered trademarks of YouTube, LLC.
- EXILIM, Photo Loader, Photo Transport, CASIO DATA TRANSPORT, and YouTube Uploader for CASIO are registered trademarks or trademarks of CASIO COMPUTER CO., LTD.
- Photo Loader with HOT ALBUM was developed based on HOT ALBUM and Photo Loader and is copyrighted by CASIO COMPUTER CO., LTD. and HOTALBUM COM, Inc. Copyright and all other rights revert to them.
- All other company or product names mentioned herein are registered trademarks or trademarks of their respective companies.

Any and all unauthorized commercial copying, distribution, and copying of the bundled software over a network are prohibited.

This product contains PrKERNELv4 Real-time OS of eSOL Co., Ltd. Copyright © 2007 eSOL Co., Ltd.



PrKERNELv4 is a registered trademark of eSOL Co., Ltd. in Japan.

This product's YouTube upload functionality is included under license from YouTube, LLC. The presence of YouTube upload functionality in this product is not an endorsement or recommendation of the product by YouTube, LLC.

### Charging

#### If the [CHARGE] lamp does not light red...

Charging cannot be performed because ambient temperature or the temperature of the charger is too hot or too cold. Wait until the camera returns to normal temperature. When the camera returns to a temperature where charging can be performed, the [CHARGE] lamp will light red.

#### If the [CHARGE] lamp flashes red...

The battery is faulty or the battery is loaded in the charger incorrectly. Remove the battery from the charger and check if its contacts are dirty. If contacts become dirty, wipe them clean with a dry cloth. When experiencing charging problems, also check to make sure that the power cord is not disconnected from the power outlet or charger.

If problems continue to occur after you perform the above steps, it could mean that the battery is faulty. Contact your nearest CASIO authorized service center.

### To replace the battery

#### 1. Open the battery cover and remove the current battery.

With the monitor screen side of the camera facing upwards, slide the stopper in the direction indicated by the arrow in the illustration. After the battery pops out, pull it the rest of the way out of the camera.

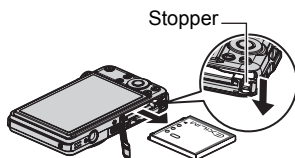

#### 2. Load a new battery.

### Battery Precautions

#### ■ Precautions during Use

- Operation provided by a battery under cold conditions is always less than operation under normal temperatures. This is due to the characteristics of the battery, not the camera.
- Charge the battery in an area where the temperature is within the range of 5°C to 35°C (41°F to 95°F). Outside this temperature range charging can take longer than normal or even fail.
- If a battery provides only very limited operation following a full charge, it probably means the battery has reached the end of its service life. Replace the battery with a new one.



## ■ Storage Precautions

- Storing the battery for a long time while it is charged can cause deterioration of battery characteristics. If you do not plan to use a battery for some time, fully use up its charge before storing it.
- Always remove the battery from the camera when you are not using it. A battery left in the camera can discharge and go dead, which will require some time to charge when you need to use the camera.
- Store batteries in a cool, dry place (20°C (68°F) or lower).

## ■ Using the Camera in another Country

---

### ■ Precautions during Use

- The bundled charger is designed for operation with any power supply in the range of 100V to 240V AC, 50/60Hz. Note, however, that the shape of the power cord plug depends on each country or geographic area. Before taking the camera and charger along on a trip, check with travel agent about the power supply requirements in your destination(s).
- Do not connect the charger to a power supply through a voltage converter or similar device. Doing so can lead to malfunction.

### ■ Extra Batteries

- Taking along extra fully charged batteries (NP-60) is recommended while on a trip in order to avoid not being able to shoot images due to the battery going dead.

## Using a Memory Card

See page 14 for information about supported memory cards and how to load a memory card.

### To replace the memory card

Press the memory card and then release it. This will cause it to pop out of the memory card slot slightly. Pull the card out the rest of the way and then insert another one.

- Never remove a card from the camera while the back lamp is flashing green. Doing so can cause the image save operation to fail and even damage the memory card.

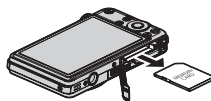

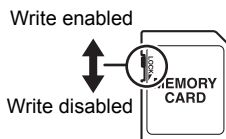

### Using a Memory Card

- SD memory cards and SDHC memory cards have a write protect switch. Use the switch when you need to guard against accidentally deleting data. Note, however, if you write protect an SD memory card you must then turn write protection off whenever you want to record to it, format it, or delete any of its images.
- If a memory card starts to behave abnormally during image playback, you can restore normal operation by reformatting it (page 132). However, it is recommended that you always take along multiple memory cards whenever using the camera far away from the home or office.
- As you record data to and delete data from a memory card a number of times, it loses its ability to retain data. Because of this, periodic re-formatting of a memory card is recommended.
- Electrostatic charge, electrical noise, and other phenomena can cause data to become corrupted or even lost. Make sure that you always back up important data on other media (CD-R, CD-RW, hard disk, etc.)



### Memory Card Handling Precautions

Certain types of cards can slow down processing speeds. In particular, you may experience problems saving high-quality (UHQ, UHQ Wide, HQ, and HQ Wide) movies. Use of certain types of memory cards increase the time it takes to record movies, which can cause movie frames to be lost. This condition is indicated by  and  flashing on the monitor screen. Use of a memory card with a maximum transfer speed of at least 10MB per second is recommended.

## ■ Discarding or Transferring Ownership of a Memory Card or the Camera

The format and delete functions of the camera do not actually delete files from the memory card. The original data remains on the card. Note that responsibility for the data on a memory card lies with you. The following procedures are recommended whenever you discard a memory card or the camera, or if you transfer ownership to another party.

- When discarding a memory card, either physically destroy the memory card or use commercially available data delete software to completely delete the data on the memory card.
- When transferring ownership of a memory card to another party, use commercially available data deletion software to completely delete the data on it.
- Use the format function (page 132) to completely delete the data in built-in memory before discarding or transferring ownership of the camera.

## Computer System Requirements for Bundled Software

Computer system requirements are different for each of the applications. Be sure to check the requirements for the particular application you are trying to use. Note that the values provided here are minimum requirements for running each application. Actual requirements are greater, depending on the number of images and the sizes of the images being handled.

### ● Windows

#### Photo Loader with HOT ALBUM

Hard Disk Drive Space: At least 2GB

Other : Internet Explorer 5.5 or higher  
DirectX 9.0 or higher  
Windows Media Player 9 or higher  
QuickTime 7.1.3 or higher

#### DirectX 9.0c

Hard Disk Drive Space: 65MB for installation (18MB on hard disk)

#### YouTube Uploader for CASIO

- Sufficient memory to run the operating system
- Computer configuration that enables playback of movies on the YouTube site
- Computer configuration that enables upload of movies to the YouTube site

#### Photo Transport 1.0

Memory : At least 64MB

Hard Disk Drive Space: At least 2MB

#### CASIO DATA TRANSPORT 1.0

- Sufficient memory to run the operating system

**Adobe Reader 8**

CPU : Pentium III Class  
Memory : At least 128MB  
Hard Disk Drive Space : At least 180MB  
Other : Internet Explorer 6.0 or higher installed

**QuickTime 7**

Memory : At least 128MB  
Operating System : Windows Vista/2000 Service Pack 4/XP

For details about the minimum system requirements for each software application, see the "Read me" files on the CASIO Digital Camera Software CD-ROM that comes bundled with the camera.

**● Macintosh****CASIO DATA TRANSPORT 1.0**

Operating System : Mac OS X 10.2.8 or greater  
Other : Sufficient memory to run the operating system.

## General Guide

The numbers in parentheses indicate the pages where each item is explained.

### ■ Camera

#### Front

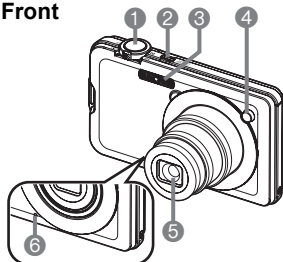

- 1 Shutter button (page 16)
- 2 [ON/OFF] (Power) (page 22)
- 3 Flash (page 26)
- 4 Front lamp (pages 18, 61, 63)
- 5 Lens
- 6 Microphone (pages 45, 89)

#### Back

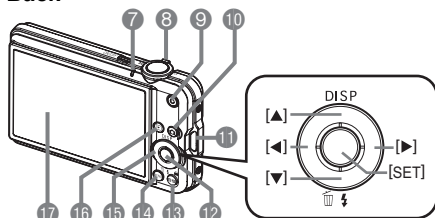

- 7 Back lamp (pages 16, 22, 26)
- 8 Zoom controller (pages 16, 42, 73, 74)
- 9 [●] (movie) button (page 45)
- 10 [RECORD] (REC) button (pages 16, 22)
- 11 Strap hole (page 2)
- 12 [SET] button (page 23)
- 13 [BS] ( ) button (page 50)
- 14 [MENU] button (page 56)
- 15 Control Button ([▲] [▼] [◀] [▶]) (page 23)
- 16 [▶] (PLAY) button (pages 19, 22)
- 17 Monitor screen (pages 133, 150)

#### Bottom

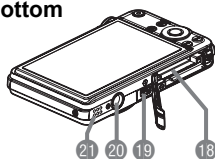

- 18 Battery/memory card slots (pages 12, 14, 144, 146)
- 19 USB/AV port (pages 75, 93, 101, 110)
- 20 Tripod hole  
Use this hole when attaching to a tripod.
- 21 Speaker

### ■ Charger Unit

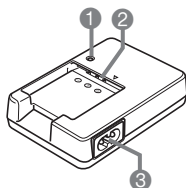

- 1 [CHARGE] Lamp
- 2 + - Contacts
- 3 AC jack

## Monitor Screen Contents

The monitor screen uses various indicators, icons, and values to keep you informed of the camera's status.

- The sample screens in this section are intended to show you the locations of all the indicators and figures that can appear on the monitor screen in various modes. They do not represent screens that actually appear on the camera.

### ■ Snapshot Recording

#### Panel : On

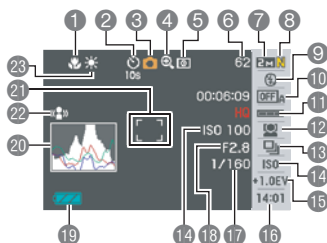

#### Panel : Off

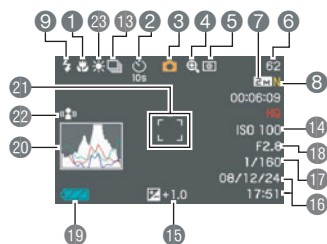

- 1 Focus mode (page 58)
- 2 Self-timer (page 61)
- 3 Recording mode (page 16)
- 4 Image deterioration indicator (page 43)
- 5 Metering mode (page 69)
- 6 Remaining snapshot memory capacity (page 161)
- 7 Snapshot image size (page 24)
- 8 Snapshot image quality (page 67)
- 9 Flash mode (page 26)
- 10 Auto shutter (page 28)
- 11 Auto shutter trigger sensitivity (page 30)
- 12 Face recognition (page 32)
- 13 Continuous shutter (page 38)
- 14 ISO sensitivity (page 40)
- 15 Exposure compensation (page 41)
- 16 Date/time (page 42)
- 17 Shutter speed
- 18 Aperture value
- 19 Battery level indicator (page 12)
- 20 Histogram (page 133)
- 21 Focus frame (pages 16, 63)
- 22 Anti Shake (page 62)
- 23 White balance setting (page 68)

### NOTE

- If the current aperture, shutter speed, ISO sensitivity, or Auto Exposure is not correct, the setting will turn orange when you half-press the shutter button.

## ■ Movie Recording

### Panel : On

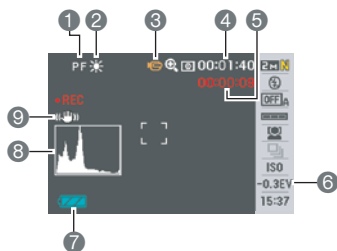

- 1 Focus mode (page 58)
- 2 White balance setting (page 68)
- 3 Recording mode (page 45)
- 4 Remaining movie memory capacity (page 45)
- 5 Movie recording time (page 45)
- 6 Exposure compensation (page 41)
- 7 Battery level indicator (page 12)
- 8 Histogram (page 133)
- 9 Anti Shake (page 62)

### Panel : Off

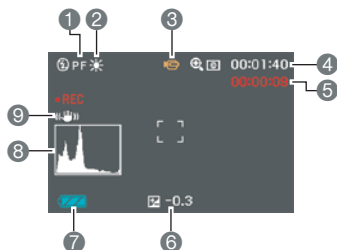

## ■ Snapshot Viewing

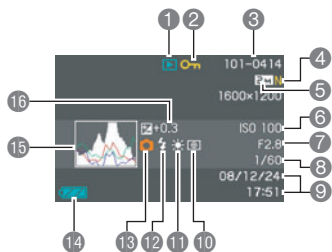

- 1 File type
- 2 Protect indicator (page 86)
- 3 Folder name/file name (page 114)
- 4 Snapshot image quality (page 67)
- 5 Snapshot image size (page 24)
- 6 ISO sensitivity (page 40)
- 7 Aperture value
- 8 Shutter speed
- 9 Date/time (page 42)
- 10 Metering mode (page 69)
- 11 White balance setting (page 83)
- 12 Flash mode (page 26)
- 13 Recording mode
- 14 Battery level indicator (page 12)
- 15 Histogram (page 133)
- 16 Exposure compensation (page 41)

## Movie Playback

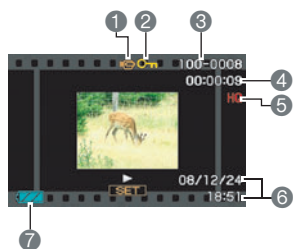

- 1 File type
- 2 Protect indicator (page 86)
- 3 Folder name/file name (page 114)
- 4 Movie recording time (page 72)
- 5 Movie image quality (page 67)
- 6 Date/time (page 42)
- 7 Battery level indicator (page 12)

## Reset Initial Default Settings

The tables in this section show the initial default settings that are configured for menu items (displayed when you press [MENU]) after you reset the camera (page 132). Menu items depend on whether the camera is in the REC mode or PLAY mode.

- A dash (-) indicates an item whose setting is not reset or an item for which there is no reset setting.

## REC Mode



### “REC” Tab

Focus	<b>AF</b> (Auto Focus)
Continuous	Off
Self-timer	Off
Auto Shutter	Off
Face Recognition	Off
Anti Shake	Off
AF Area	<b>Spot</b>
AF Assist Light	On
Digital Zoom	On
L/R Key	Off
Quick Shutter	On

Grid	Off
Review	On
Icon Help	On
Memory	<b>BS</b> BEST SHOT: Off / Auto Shutter: Off / Flash: On / Focus: Off / White Balance: Off / ISO: Off / AF Area: On / Metering: Off / Continuous: Off / Self-timer: Off / Flash Intensity: Off / Digital Zoom: On / MF Position: Off / Zoom Position: Off





## “Quality” Tab

<b>Size</b>	10M (3648×2736)
 <b>Quality (Snapshots)</b>	Normal
 <b>Quality (Movies)</b>	HQ
<b>EV Shift</b>	0.0
<b>White Balance</b>	Auto
<b>ISO</b>	Auto
<b>Metering</b>	 Multi

<b>Dynamic Range</b>	Off
<b>Portrait Refiner</b>	Off
<b>Color Filter</b>	Off
<b>Sharpness</b>	0
<b>Saturation</b>	0
<b>Contrast</b>	0
<b>Flash Intensity</b>	0
<b>Flash Assist</b>	Auto

## “Set Up” Tab

 <b>Panel</b>	On
 <b>Display</b>	Wide
<b>Screen</b>	Auto 2
<b>Sounds</b>	–
<b>Startup</b>	Off
<b>File No.</b>	Continue
<b>World Time</b>	Home
<b>Timestamp</b>	Off
<b>Adjust</b>	–
<b>Date Style</b>	–

<b>Language</b>	–
<b>DATA View</b>	List View
<b>Sleep</b>	1 min
<b>Auto Power Off</b>	1 min
<b>REC/PLAY</b>	Power On
<b>USB</b>	Mass Storage
<b>Video Out</b>	NTSC 4:3
<b>Format</b>	–
<b>Reset</b>	–

## ■ PLAY Mode

### “PLAY” Tab

<b>Slideshow</b>	–
<b>Layout Print</b>	–
<b>MOTION PRINT</b>	9 frames
<b>Movie Editing</b>	–
<b>Dynamic Range</b>	–
<b>White Balance</b>	–
<b>Brightness</b>	0
<b>Keystone</b>	–
<b>Color Correction</b>	–

<b>DPOF Printing</b>	–
<b>Protect</b>	–
<b>Date/Time</b>	–
<b>Rotation</b>	–
<b>Resize</b>	7M (3072×2304)
<b>Trimming</b>	–
<b>Dubbing</b>	–
<b>Copy</b>	–

---









### “Set Up” Tab

- The contents of the “Set Up” tab are the same in the REC mode and PLAY mode.

## When things don't go right...

### Troubleshooting

Problem	Possible Cause and Recommended Action
<b>Power Supply</b>	
Power does not turn on.	<ol style="list-style-type: none"><li>1)The battery may not be loaded correctly (page 12).</li><li>2)The battery may be dead. Charge the battery (page 11). If the battery goes dead soon after being charged, it means the battery has reached the end of its life and needs to be replaced. Purchase a separately available CASIO NP-60 rechargeable lithium ion battery.</li></ol>
The camera suddenly powers down.	<ol style="list-style-type: none"><li>1)Auto Power Off may have activated (page 130). Turn power back on.</li><li>2)The battery may be dead. Charge the battery (page 11).</li><li>3)The camera's protection function may have activated because camera temperature is too high. Turn off the camera and wait until it cools down before trying to use it again.</li></ol>
Power will not turn off. Nothing happens when a button is pressed.	Remove the battery from the camera and then reload it.
<b>Image Recording</b>	
Image is not recorded when the shutter button is pressed.	<ol style="list-style-type: none"><li>1)If the camera is in the PLAY mode, press <b>[RECORD]</b> (REC) to enter the REC Mode.</li><li>2)If the flash is charging, wait until the charge operation finishes.</li><li>3)If the message "Memory Full" appears, transfer images to your computer, delete images you no longer need, or use a different memory card.</li></ol>
Auto Focus does not focus properly	<ol style="list-style-type: none"><li>1)If the lens is dirty, clean it off.</li><li>2)The subject may not be in the center of the focus frame when you compose the image.</li><li>3)The subject you are shooting may not be a type that is compatible with Auto Focus (page 21). Use manual focus (page 58).</li><li>4)You may be moving the camera when shooting. Try shooting with Anti Shake or use a tripod.</li><li>5)You may be pressing the shutter button all the way without waiting for Auto Focus. Half-press the shutter button and allow enough time for Auto Focus to focus.</li></ol>
The subject is out of focus in the recorded image.	The image may not be focused properly. When composing the image, make sure the subject is located inside the focus frame.

Problem	Possible Cause and Recommended Action
The flash does not fire.	1) If  (Flash Off) is selected as the flash mode, change to another mode (page 26). 2) If the battery is dead, charge it (page 11). 3) If a BEST SHOT scene that uses  (Flash Off) is selected, change to a different flash mode (page 26) or select a different BEST SHOT scene (page 50).
Camera powers down during Self-timer countdown.	The battery may be dead. Charge the battery (page 11).
The monitor screen image is out of focus.	1) You may be using Manual Focus and have not focused the image. Focus the image (page 58). 2) You may be using  (Macro Mode) for scenery or portraits. Use Auto Focus for scenery and portrait shots (page 58). 3) You may be trying to use Auto Focus or  (Infinity Mode) when shooting a close-up shot. Use the  (Macro Mode) for close ups (page 58).
There is a vertical line in the monitor screen image.	Shooting a very brightly lit subject can cause a vertical band to appear in the monitor screen image. This is a CCD phenomenon known as “vertical smear”, and does not indicate malfunction of the camera. Note that vertical smear is not recorded with the image in the case of a snapshot, but it is recorded in the case of a movie.
There is digital noise in images.	1) Sensitivity may have been increased automatically for a dark subject, which increases the chance of digital noise. Use a light or some other means to illuminate the subject. 2) You may be attempting to shoot in a dark location with  (Flash Off) selected, which can increase digital noise and make images appear coarse. In this case, turn on flash (page 26) or use lights for illumination. 3) Flash assist or dynamic range may be enabled for snapshots, which can cause an increase in digital noise. Use a light or some other means to illuminate the subject.
A recorded image was not saved.	1) Camera power may have been turned off before the save operation was complete, which will result in the image not being saved. If the battery indicator shows  , charge the battery as soon as possible (page 12). 2) You may have removed the memory card from the camera before the save operation was complete, which will result in the image not being saved. Do not remove the memory card before the save operation is complete.
Though available lighting is bright, the faces of people in the image are dark.	Not enough light is reaching the subjects. Change the flash mode setting to  (Flash On) for daylight synchro flash (page 26), or adjust EV shift to the + side (page 41).

Problem	Possible Cause and Recommended Action
Subjects are too dark when shooting images in a seashore or ski area.	Sunlight reflected by water, sand, or snow, can cause underexposure of images. Change the flash mode setting to <b>☑</b> (Flash On) for daylight synchro flash (page 26), or adjust EV shift to the + side (page 41).
The focus frame does not appear on the monitor screen.	Normally, turning off the camera while “Detect Smile” is selected for Auto Shutter will cause the camera’s face recognition setting to change to “Normal”. You will need to change the face recognition setting again after turn on the camera. You can tell the camera to remember the Auto Shutter setting by selecting “On” for the “Auto Shutter” power on default setting (page 66).
Digital zoom (including HD zoom) does not work. The zoom bar indicates zoom only up to a zoom factor of 3.0.	<ol style="list-style-type: none"> <li>1)The digital zoom setting may be turned off. Turn on digital zoom (page 64).</li> <li>2)Date stamping may be turned on, which will cause digital zoom to be disabled. Turn off date stamping (page 127).</li> </ol>
A family member’s face is not detected correctly, even though the face has been pre-recorded.	Though face characteristics were pre-recorded for your family member, the data may have been faulty. Other possible causes may be shooting at an angle or the facial features of the subject. Try re-recording the face of the family member who is not being detected (page 33).
When shooting with Auto Shutter, the shutter does not trigger.	Auto Shutter may not trigger when shooting under very bright or very dark conditions, or when shooting a fast moving subject, etc. If this happens, try changing the Auto Shutter Trigger Sensitivity setting (page 30), or press the shutter button all the way down to release the shutter and shoot the image.
The image is out of focus during movie recording.	<ol style="list-style-type: none"> <li>1)Focusing may not be possible because the subject is outside the focus range. Shoot within the allowable range.</li> <li>2)The lens may be dirty. Clean the lens (page 140).</li> </ol>
<b>Playback</b>	
The color of the playback image is different from what appears on the monitor screen when shooting.	Sunlight or light from another source may be shining directly into the lens when you are shooting. Position the camera so sunlight does not shine directly into the lens.
Images are not displayed.	This camera cannot display non-DCF images recorded onto a memory card using another digital camera.

Problem	Possible Cause and Recommended Action
<p>Images cannot be edited (with Layout Print, resizing, trimming, keystone correction, color restoration, date/ time editing, rotation).</p>	<p>Note that you cannot edit the following types of snapshots.</p> <ul style="list-style-type: none"> <li>• Snapshots created using MOTION PRINT</li> <li>• Movies</li> <li>• Snapshots recorded with another camera</li> </ul>
<b>Other</b>	
<p>The wrong date and time are displayed.</p>	<p>The date and time setting is off. Set the correct date and time (page 128).</p>
<p>The messages on the display are in the wrong language.</p>	<p>The wrong display language is selected. Change the display language setting (page 129).</p>
<p>Images cannot be transferred over a USB connection.</p>	<ol style="list-style-type: none"> <li>1)The USB cable may not be connected securely. Check all connections.</li> <li>2)Your computer is running Windows 98SE or 98 and does not have the USB driver installed. Install the USB driver (page 101). You can download the USB driver from the Official CASIO Digital Camera Website at <a href="http://www.exilim.com/">http://www.exilim.com/</a></li> <li>3)Your computer is running Windows 98SE or 98 and does not have the USB driver installed correctly. Reinstall the USB driver correctly (page 101).</li> <li>4)The wrong USB communication protocol is selected. Select the correct USB communication protocol in accordance with the type of device you are connecting (pages 101, 110).</li> <li>5)If the camera is not turned on, turn it on.</li> </ol>
<p>Language selection screen appears when the camera is turned on.</p>	<ol style="list-style-type: none"> <li>1)You did not configure initial settings after purchasing the camera or the battery may have been left with a dead battery. Check the camera setup (pages 13, 129).</li> <li>2)There may be a problem with the camera's memory data. If this is the case, perform the reset operation to initialize the camera's setup (page 132). After that, configure each setting. If the language selection screen does not re-appear when you turn the camera on, it means that the camera's memory management data has been restored. If the same message appears after you turn power back on, contact your retailer or a CASIO authorized service center.</li> </ol>

## Display Messages

<b>ALERT</b>	The camera's protection function may have activated because camera temperature is too high. Turn off the camera and wait until it cools down before trying to use it again.
<b>Battery is low.</b>	Battery power is low.
<b>Cannot correct image!</b>	Keystone correction of the image cannot be performed for some reason. The image will be stored as-is, without correction (page 53).
<b>Cannot find the file.</b>	The image you specified with the slideshow "Images" setting cannot be found. Change the "Images" setting (page 77) and try again.
<b>Cannot register any more files.</b>	You are attempting to save a user BEST SHOT scene in the "SCENE" folder when the folder already contains 999 user scenes (page 52).
<b>Card ERROR</b>	<p>There is something wrong with the memory card. Turn off the camera, remove the memory card and then reload it into the camera. If this message re-appears when you turn the camera back on, format the memory card (page 132).</p> <p> <b>IMPORTANT!</b></p> <ul style="list-style-type: none"><li>• Formatting a memory card deletes all its files. Before formatting, try transferring recoverable files to a computer or some other storage device.</li></ul>
<b>Check connections!</b>	<ul style="list-style-type: none"><li>• You are attempting to connect the camera to a printer while the camera's USB settings are not compatible with the USB system of the printer (page 93).</li><li>• Your computer is running Windows 98SE or 98 and does not have the USB driver installed (page 101).</li></ul>
<b>Files could not be saved because battery is low.</b>	Battery power is low, so an image file could not be saved.
<b>Folder cannot be created.</b>	You are trying to record a file while there are already 9999 files stored in the 999th folder. If you want to record more, delete files you no longer need (page 20).
<b>LENS ERROR</b>	This message appears and the camera turns off whenever lens performs some unexpected operation. If the same message appears after you turn power back on, contact a CASIO authorized service center or your original retailer.
<b>Load paper!</b>	The printer ran out of paper while printing.
<b>Memory Full</b>	Memory is full with images you recorded and/or files saved by editing operations. Delete files you no longer need (page 20).

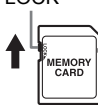
<b>Printing Error</b>	An error occurred while printing. <ul style="list-style-type: none"> <li>• The printer is turned off.</li> <li>• The printer generated an error, etc.</li> </ul>
<b>Record Error</b>	Image compression could not be performed for some reason during image data storage. Shoot the image again.
<b>RETRY POWER ON</b>	The lens came into contact with an obstruction while moving. The camera will turn off automatically when this message appears. Remove the obstruction and turn power back on again.
<b>SYSTEM ERROR</b>	Your camera system is corrupted. Contact your retailer or an authorized CASIO authorized service center.
<b>The card is locked.</b>	The LOCK switch of the SD or SDHC memory card loaded in the camera is in the locked position. You cannot store images to or delete images from a memory card that is locked. <div style="float: right; text-align: center;"> <p>LOCK</p>  </div>
<b>There are no files.</b>	There are no files in built-in memory or on the memory card.
<b>There are no printing images. Set up DPOF.</b>	There are currently no files specified for printing. Configure the required DPOF settings (page 95).
<b>There is no image to register.</b>	The setup you are trying to save is for an image that cannot be saved as a user BEST SHOT scene.
<b>This card is not formatted.</b>	The memory card loaded in the camera is not formatted. Format the memory card (page 132).
<b>This file cannot be played.</b>	The file you are trying to access is corrupted or is a type that cannot be displayed by this camera.
<b>This function cannot be used.</b>	You attempted to copy images from built-in memory to a memory card while there is no memory card loaded in the camera (page 91).



## Number of Snapshots and Movie Recording Time

### Snapshot

Image Size (Pixels)	Image Quality	Approximate Image File Size	Built-in Memory (11.8MB) Capacity	SD Memory Card (1GB) Capacity
10M (3648×2736)	Fine	6.4 MB	1 shot	151 shots
	Normal	3.38 MB	3 shots	286 shots
	Economy	2.27 MB	5 shots	426 shots
3:2 (3648×2432)	Fine	5.6 MB	2 shots	172 shots
	Normal	2.97 MB	4 shots	325 shots
	Economy	2 MB	5 shots	483 shots
16:9 (3648×2048)	Fine	4.59 MB	2 shots	210 shots
	Normal	2.46 MB	4 shots	393 shots
	Economy	1.67 MB	7 shots	579 shots
7M (3072×2304)	Fine	4.3 MB	2 shots	224 shots
	Normal	2.31 MB	5 shots	418 shots
	Economy	1.57 MB	7 shots	616 shots
4M (2304×1728)	Fine	2.5 MB	4 shots	386 shots
	Normal	1.4 MB	8 shots	690 shots
	Economy	900 KB	13 shots	1074 shots
2M (1600×1200)	Fine	1.26 MB	9 shots	767 shots
	Normal	790 KB	15 shots	1224 shots
	Economy	470 KB	25 shots	2057 shots
VGA (640×480)	Fine	330 KB	35 shots	2930 shots
	Normal	190 KB	61 shots	5088 shots
	Economy	140 KB	83 shots	6906 shots

## Movies

Image Quality (Pixels)	Approximate Data Rate (Frame Rate)	Built-in Memory (11.8MB) Capacity	SD Memory Card (1GB) Capacity	File Size of 1-minute Movie
UHQ 640×480	5.8 Megabits/second (30 frames/second)	13 seconds	22 minutes 47 seconds	43.3 MB
UHQ Wide 848×480	7.0 Megabits/second (30 frames/second)	11 seconds	18 minutes 52 seconds	52.3 MB
HQ 640×480	3.8 Megabits/second (30 frames/second)	19 seconds	34 minutes 49 seconds	28.3 MB
HQ Wide 848×480	4.4 Megabits/second (30 frames/second)	17 seconds	30 minutes 3 seconds	32.8 MB
Normal 640×480	2.1 Megabits/second (30 frames/second)	34 seconds	62 minutes	15.7 MB
LP 320×240	545 Kilobits/second (15 frames/second)	129 seconds	4 hours	4.1 MB
YouTube 640×480	1.4 Megabits/second (30 frames/second)	51 seconds	94 minutes	10.4 MB

- \* The number of image values are approximate and are provided for reference only. The actual number of images you may be able to record may be less than that indicated on the monitor screen.
- \* Image file sizes are approximate and are provided for reference only. Actual image file sizes vary depending on subject type.
- \* The above values are based on use of a Panasonic brand PRO HIGH SPEED SD memory card. The number of images you can save depends on the type of memory card you are using.
- \* When using a memory card with a different capacity, calculate the number of images as a percentage of 1GB.
- \* Each movie can be up to 10 minutes long. Movie recording stops automatically after 10 minutes of recording.

## Specifications

<b>Product Type</b>	Digital Camera
<b>Model</b>	EX-S10
<b>File Format</b>	Snapshots: JPEG (Exif Version 2.2); DCF 1.0 standard; DPOF compliant Movies: MOV, H.264/AVC standard, IMA-ADPCM audio (monaural) Audio (Voice Recording): WAV (monaural)
<b>Recording Media</b>	Built-in Memory (Image Storage Area: 11.8MB) SD/SDHC/MMC/MMC <i>plus</i>
<b>Recorded Image Sizes</b>	Snapshot: 10M (3648×2736), 3:2 (3648×2432), 16:9 (3648×2048), 7M (3072×2304), 4M (2304×1728), 2M (1600×1200), VGA (640×480) Movies: UHQ, HQ, Normal (640×480), LP (320×240), UHQ Wide, HQ Wide (848×480)
<b>Delete</b>	1 file; all files (with memory protection feature)
<b>Effective Pixels</b>	10.10 Megapixels
<b>Imaging Element</b>	Size: 1/2.3-inch square pixel CCD Total Pixels: 10.34 Megapixels
<b>Lens/Focal Distance</b>	F2.8 (W) to 5.3 (T) f= 6.3 to 18.9 mm (equivalent to 36 to 108 mm in 35 mm format) Six lenses in five groups, including aspherical lens.
<b>Zoom</b>	3X optical zoom, 4X digital zoom (12X in combination with optical zoom) 17.1X maximum HD Zoom (in combination with optical zoom, VGA size)
<b>Focusing</b>	Contrast Detection Auto Focus <ul style="list-style-type: none"> <li>• Focus Modes: Auto Focus, Macro Focus, Pan Focus, Infinity, Manual Focus</li> <li>• AF Area: Spot, Multi, Tracking; with AF assist lamp</li> </ul>
<b>Approximate Focus (Snapshot) (From Lens Surface)</b>	Auto Focus: 40 cm to ∞ (1.3' to ∞) (Wide Angle) Macro Focus: 15 cm to 50cm (5.9" to 19.7") (Wide Angle) Infinity: ∞ (Wide Angle) Manual: 15 cm to ∞ (5.9" to ∞) (Wide Angle) * Range is affected by optical zoom.
<b>Metering</b>	Multi-pattern, center weighted, and spot by imaging element
<b>Exposure Control</b>	Program AE
<b>Exposure Compensation</b>	-2.0 EV to +2.0 EV (in 1/3EV steps)
<b>Shutter</b>	CCD shutter, mechanical shutter
<b>Shutter Speed</b>	Snapshot (Auto): 1/2 to 1/2000 second Snapshot (Night Scene): 4 to 1/2000 second * May differ due to the camera setup.

<b>Aperture Value</b>	F2.8 (W) to F7.9 (W) (When used with ND filter) * Using optical zoom changes the aperture value.
<b>White Balance</b>	Auto, Daylight, Overcast, Shade, Day White Fluorescent, Daylight Fluorescent, Tungsten, Manual WB
<b>Sensitivity (Standard Output Sensitivity, Recommended Exposure Index)</b>	Snapshots: Auto, ISO 50, ISO 100, ISO 200, ISO 400, ISO 800, ISO 1600 equivalent Movies: Auto
<b>Self-timer</b>	Approximate Trigger Times: 10 seconds, 2 seconds, Triple Selftimer
<b>Flash Modes</b>	Auto, Off, On, Soft, Red-eye reduction
<b>Flash Range (ISO Sensitivity: Auto)</b>	Wide Angle: Normal: 0.2 m to 2.8 m (0.7' to 9.2') Flash Continuous Shutter: 0.4 m to 1.8 m (1.3' to 5.9') Telephoto: Normal: 0.4 m to 1.5 m (1.3' to 4.9') Flash Continuous Shutter: 0.4 m to 1.0 m (1.3' to 3.3') * Range is affected by optical zoom.
<b>Flash Charging Time</b>	Approximately 3 seconds maximum
<b>Recording</b>	Snapshots (with audio); Macro; Self-timer; Continuous Shutter (Normal Speed CS, HighSpeed CS, Flash CS); BEST SHOT; Auto Shutter; Face Recognition; Movies (normal movie, Prerecord Movie, and For YouTube) (with monaural audio); Audio (Voice Recording)
<b>Approximate Maximum Audio Recording Times</b>	After Recording: 30 seconds per image Voice Recording: 36 minutes 52 seconds (when using built-in memory)
<b>Monitor Screen</b>	2.7-inch wide TFT color LCD (high-performance clear liquid crystal) 230,160 (959×240) dots
<b>Viewfinder</b>	Monitor Screen
<b>Timekeeping Function</b>	Built-in quartz digital clock Date and Time: Recorded with image data With time stamp function Auto Calendar: To 2049
<b>World Time</b>	162 cities in 32 time zones City name, date, time, summer time
<b>Input/Output Terminals</b>	USB/AV port, Hi-Speed USB compatible
<b>Microphone</b>	Monaural
<b>Speaker</b>	Monaural
<b>Power Requirements</b>	Rechargeable lithium ion battery (NP-60) ×1

## Approximate Battery Life

All of the values provided below represent the approximate amount of time under normal temperature (23°C (73°F)) before the camera turns off. These values are not guaranteed. Low temperatures shorten battery life.

<b>Number of Shots (CIPA) (Operating Time)*<sup>1</sup></b>	280 shots
<b>Continuous Playback (Snapshots)*<sup>2</sup></b>	3 hours 10 minutes
<b>Approximate continuous movie recording time</b>	120 minutes
<b>Continuous Voice Recording*<sup>3</sup></b>	6 hours 40 minutes

- Battery: NP-60 (Rated Capacity: 720 mAh)
- Recording Medium: 1GB SD memory card (Panasonic brand PRO HIGH SPEED)
- Measurement Conditions

\*<sup>1</sup> Approximate number of shots (CIPA) (Operating Time)

In accordance with CIPA (Camera and Imaging Products Association) standards Normal temperature (23°C (73°F)), monitor on, zoom operation between full wide and full telephoto every 30 seconds, during which two images are shot with flash; power turned off and back on every time 10 images are shot.

\*<sup>2</sup> Approximate playback time

Standard temperature (23°C (73°F)), one-image scroll approximately every 10 seconds

\*<sup>3</sup> Approximate continuous recording time

- The above values are based a new battery, starting from a full charge. Repeated charging shortens battery life.
- Frequency of flash, zoom, and Auto Focus usage, and the time the camera is on greatly affects recording time and number of shots values.

---

<b>Power Consumption</b>	3.7 V DC, Approximately 4.2 W
<b>Dimensions</b>	94.2 (W) × 54.6 (H) × 15.0 (D) mm (3.7" (W) × 2.1" (H) × 0.6" (D)) (excluding projections; 13.8 mm (0.5") at thinnest point)
<b>Weight</b>	Approximately 113 g (4.0 oz) (excluding battery and bundled accessories)

---

## ■ Rechargeable lithium ion battery (NP-60)

<b>Rated Voltage</b>	3.7 V
<b>Rated Capacitance</b>	720 mAh
<b>Operating Temperature</b>	0 to 40°C (32 to 104°F)
<b>Dimensions</b>	37.9 (W) × 42.3 (H) × 5.0 (D) mm (1.49" (W) × 1.67" (H) × 0.20" (D))
<b>Weight</b>	Approximately 18 g (0.63 oz)

## ■ Charger unit (BC-60L)

<b>Input Power</b>	100 to 240 V AC, 80 mA, 50/60 Hz
<b>Output Power</b>	4.2 V DC, 600 mA
<b>Operating Temperature</b>	5 to 35°C (41 to 95°F)
<b>Supported Battery Type</b>	Rechargeable lithium ion battery (NP-60)
<b>Charging Time</b>	90 minutes
<b>Dimensions</b>	60 (W) × 20 (H) × 86 (D) mm (2.4" (W) × 0.79" (H) × 3.4" (D)) (excluding projections)
<b>Weight</b>	Approximately 62 g (2.2 oz)

- Power cord precautions for use in Singapore  
The power cord set is not supplied. The power cord used must comply with relevant national and/or international standards.

**CASIO®**

**CASIO COMPUTER CO.,LTD.**  
6-2, Hon-machi 1-chome  
Shibuya-ku, Tokyo 151-8543, Japan