

EXILIM

E

Digital Camera

EX-S20/EX-M20

User's Guide

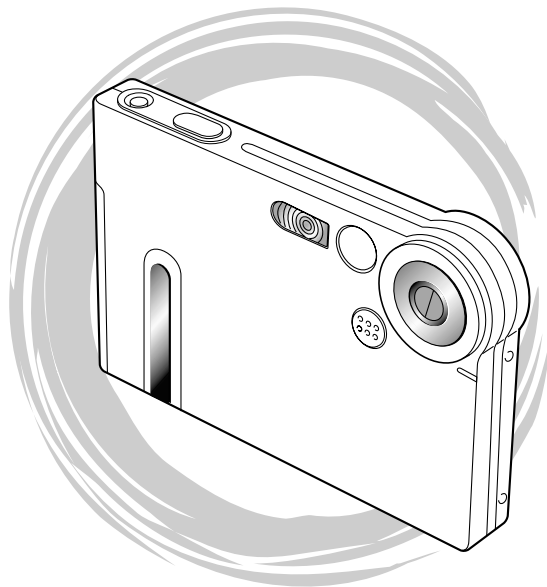

EX-M20

Thank you for purchasing this CASIO Product.

- Before using it, be sure to read the precautions contained in this User's Guide.
- Keep the User's Guide in a safe place for future reference.
- For the most up-to-date information about this product, visit the official Exilim Website at <http://www.exilim.com/>.

K858PCM1DMX

CASIO®

INTRODUCTION

Unpacking

Check to make sure that all of the items shown below are included with your camera. If something is missing, contact your dealer as soon as possible.

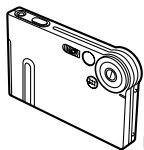

EX-M20

Camera

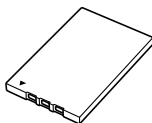

Rechargeable lithium ion battery
(NP-20)

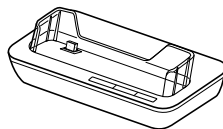

USB Cradle (CA-23)

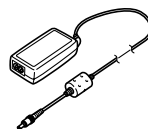

Special AC Adaptor
(AD-C51G)

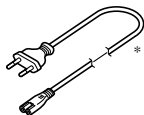

* The shape of the AC power cord plug varies according to country or geographic area.

AC power cord *



Strap



CD-ROM

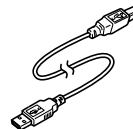

USB Cable



* Comes with EX-M20 only

LCD Remote Controller

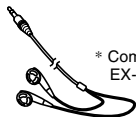

* Comes with EX-M20 only

Stereo Headphones



Basic Reference

Contents

2 INTRODUCTION

Unpacking	2
Features	9
Precautions	11
General Precautions	11
Data Error Precautions	13
Operating conditions	13
Condensation	14
Lens	14
Other	15

16 QUICK START GUIDE

First, charge the battery!	16
To configure display language and clock settings	17
To record an image	18
To view a recorded image	18
To delete an image	19

20 GETTING READY

About This Manual	20
General Guide	21
Camera	21
USB Cradle	22
Monitor Screen Contents	23
REC mode	23
PLAY mode	24
Changing the Contents of the Monitor Screen	25
Indicator Lamps	25
Attaching the Strap	26
Power Requirements	26
To load the battery	26
To charge the battery	28
Power Supply Precautions	32
Turning the Camera On and Off	35
Auto Power Off (APO)	36
Using the On-screen Menus	37
Configuring Display Language and Clock Settings ...	39
To configure display language and clock settings	40

43 BASIC IMAGE RECORDING

Recording an Image	43
Aiming the Camera	43
Recording an Image	44
About the REC Mode Monitor Screen	45
Recording Precautions	45
Using Zoom	46
Using the Flash	47
Flash Precautions	49
Recording Macro Images	50
Using the Self-timer	51
Specifying Image Size and Quality	52
To specify the image size	52
To specify image quality	53

55 OTHER RECORDING FUNCTIONS

Exposure Compensation (EV Shift)	55
Adjusting White Balance	56
Adjusting White Balance Manually	57
Using the BESTSHOT Mode	58
Creating Your Own BESTSHOT Setup	60
Combining Shots of Two People into a Single Image (Coupling Shot)	62
Recording a Subject onto an Existing Background Image (Pre-shot)	64

Using the Movie Mode	66
Recording Audio (EX-M20 Only)	67
Adding Audio to a Snapshot	67
Recording Your Voice	69
Using the Histogram	70
REC Mode Camera Settings	72
Specifying ISO Sensitivity	72
Turning the On-screen Grid On and Off	73
Turning Image Review On and Off	73
Assigning Functions to the [◀] and [▶] Keys	74
Assigning Functions to the [▲] and [▼] Keys	75
Specifying Power On Default Settings	76
Resetting the Camera	77

78 PLAYBACK

Basic Playback Operation	78
Playing an Audio Snapshot (EX-M20 Only)	79
Flipping the Display	80
Zooming the Display Image	81
Resizing an Image	82
Cropping an Image	83
Playing a Movie	84
Displaying the Calendar Screen	86

INTRODUCTION

Playing a Slide Show	87
To specify the slideshow images	88
To specify the slideshow time	89
To set the slideshow interval	90
Using the Photo Stand Feature	90
Rotating the Display Image	91
Using Image Roulette	92
Adding Audio to a Snapshot (EX-M20 Only)	93
To re-record audio	94
Playing Back a Voice Recording File (EX-M20 Only)	95

97 DELETING FILES

Deleting a Single File	97
Deleting All Files	98

99 FILE MANAGEMENT

Folders	99
Memory Folders and Files	99
Protecting Files	100
To protect a single file	100
To protect all files in memory	101
DPOF	101
To configure print settings for a single image	102
To configure print settings for all images	103

PRINT Image Matching II	104
Exif Print	104
Using USB DIRECT-PRINT	105
Using the FAVORITE Folder	107
To copy a file to the FAVORITE folder	107
To display a file in the FAVORITE folder	108
To delete a file from the FAVORITE folder	109
To delete all files from the FAVORITE folder	110

111 OTHER SETTINGS

Turning the Key Tone On and Off (EX-S20)	111
Configuring Sound Settings (EX-M20)	111
To configure sound settings	111
To set the volume level	112
Specifying an Image for the Startup Screen	113
Configuring Power Down Image Settings	114
Specifying the File Name Serial Number Generation Method	116
Using the Alarm	117
To set an alarm	117
Stopping the Alarm	118
Setting the Clock	118
To select your Home Time zone	118
To set the current time and date	119
Changing the Date Format	120

INTRODUCTION

Using World Time	120
To display the World Time screen	120
To configure World Time settings	121
To configure summer time (DST) settings	122
Changing the Display Language	123
Formatting Built-in Memory	123

125 USING A MEMORY CARD

Using a Memory Card	126
To insert a memory card into the camera	126
To remove a memory card from the camera	126
Formatting a Memory Card	127
Memory Card Precautions	128
Copying Files	129
To copy all the files in built-in memory to a memory card	129
To copy a file from a memory card to built-in memory	130

131 VIEWING IMAGES ON A COMPUTER

Using the Camera with a Windows Computer	131
USB Connection Precautions	136
Using the Camera with a Macintosh Computer	136
USB Connection Precautions	140
Operations You Can Perform from Your Computer ...	140
Using a Memory Card to Transfer Images to a Computer	141

Memory Data	142
DCF Protocol	142
Memory Directory Structure	142
Image Files Supported by the Camera	144
Built-in Memory and Memory Card Precautions	144

145 USING THE CAMERA WITH A COMPUTER

Using the Album Feature	145
Creating an album	145
Selecting an Album Layout	146
Configuring Detailed Album Settings	147
Viewing Album Files	149
Saving an Album	152
Installing the Software from the CD-ROM	152
About the bundled CD-ROM	152
Computer System Requirements	153
Installing Software from the CD-ROM in Windows ...	154
Getting Started	154
Selecting a Language	154
Viewing the Contents of the "Read me" File	155
Installing an Application	155
Viewing User Documentation (PDF Files)	156
User Registration	156
Exiting the Menu Application	156
Installing Software from the CD-ROM on a Macintosh	157
Installing Software	157
Viewing User Documentation (PDF Files)	158

159 PLAYING AN AUDIO FILE (EX-M20 Only)

Transferring Audio Files to the Camera	159
Preparing the Camera for Audio Player Operation ...	160
Using the Camera as an Audio Player	161
General Guide	161
Basic Remote Controller Operations	163
Playing Back Audio Files	164
Specifying the Audio Playback Mode	164
Playing Back Tracks Randomly	164
Selecting a Specific Track for Playback	165
Specifying the Track Playback Sequence	166
Using BASS BOOST	168
Deleting MP3 Files from File Memory	169
Deleting a Single MP3 File	170
Deleting All MP3 Files	171
Disabling Remote Controller Button Operations	171
LCD Remote Control Error Messages	172
Audio Playback Precautions	172

173 APPENDIX

Menu Reference	173
Indicator Lamp Reference	175
Camera Indicator Lamps	175
USB Cradle Indicator Lamps	177
Troubleshooting Guide	178
Display Messages	181
Specifications	182
Main Specifications	182

INTRODUCTION

»» IMPORTANT! ««

- The contents of this manual are subject to change without notice.
- CASIO COMPUTER CO., LTD. assumes no responsibility for any damage or loss resulting from the use of this manual.
- CASIO COMPUTER CO., LTD. assumes no responsibility for any loss or claims by third parties which may arise through the use of the EX-S20/EX-M20.
- CASIO COMPUTER CO., LTD. shall not be held liable for any damages or losses suffered by you or any third party due to the use of Photo Loader and/or Photohands.
- CASIO COMPUTER CO., LTD. assumes no responsibility for any damage or loss caused by deletion of data as a result of malfunction, repairs, or battery replacement. Be sure to back up all important data on other media to protect against its loss.
 - *The SD logo is a registered trademark.*
 - *Windows, Internet Explorer, and DirectX are registered trademarks of Microsoft Corporation.*
 - *Macintosh is a registered trademark of Apple Computer, Inc.*
 - *MultiMediaCard is a trademark of Infineon Technologies AG of Germany, and licensed to the MultiMediaCard Association (MMCA).*
 - *Acrobat and Acrobat Reader are trademarks of Adobe Systems Incorporated.*

- *The USB driver (mass storage) uses Phoenix Technologies Ltd. software.
Compatibility Software Copyright © 1997
Phoenix Technologies Ltd., All Rights Reserved.*
- *MPEG Layer-3 audio decoding technology licensed from Fraunhofer IIS and Thomson Multimedia.*
- *Other company, product and service names used herein may also be trademarks or service marks of others.*
- *Photo Loader and Photohands are the property of CASIO COMPUTER CO., LTD. Except as stipulated above, all copyrights and other related rights to these applications revert to CASIO COMPUTER CO., LTD.*

■ Copyright Restrictions

Except for the purposes of your own personal enjoyment, unauthorized copying of snapshot files, movie files, audio files, and music files violates copyright laws and international contracts. Distribution to third parties of such files over the Internet without permission of the copyright holder, whether for profit or for free, violates copyright laws and international contracts.

Features

- **2.0 million Effective Pixels**
A high-resolution megapixel CCD provides 2.0 million effective pixels (2.11 million total pixels) for images that print beautifully.
- **Fixed focus lens for quick operation**
Fixed focus eliminates the need for lens movement, which shortens startup time and shooting time.
- **Macro Function**
Text images come out clear and easy-to read.
- **Compact electric lens barrier**
Protects the lens against damage.
- **1.6-inch TFT color LCD monitor screen**
- **4X digital zoom**
- **10MB Flash memory**
Images can be recorded without using a memory card.
- **Support for SD memory cards and MMC (MultiMedia Cards) for memory expansion**
- **Easy Charging**
Just place the camera onto the USB cradle to charge its battery.
- **Easy Image Transfer**
Transfer images to a computer simply by placing the camera onto the USB cradle.
- **Photo Stand feature**
A slideshow of images in file memory can be played while the camera is on its USB cradle.
- **BESTSHOT**
Simply select the sample scene that matches the type of image you are trying to record and the camera performs troublesome setups automatically for beautiful pictures every time.
- **Coupling Shot and Pre-shot**
Coupling Shot lets you combine two subjects into a single image, while Pre-shot lets you add a subject to a previously recorded background image. This means you can create images that include you and your friend, even if you are the only two people around. You can use Coupling Shot and Pre-shot by selecting the applicable sample images in the BESTSHOT mode.
- **Image Roulette Feature**
Images cycle like a slot machine on the display until one of them remains.
- **Triple Self-timer mode**
The self-timer can be set up to repeat three times, automatically.

INTRODUCTION

- **Real-time histogram**
An on-screen histogram lets you adjust exposure as you view the effect on overall image brightness, which makes shooting under difficult lighting conditions easier than ever before.
- **World Time**
A simple operation sets the current time for your current location. You can select from among 162 cities in 32 time zones.
- **Alarm**
A built-in alarm helps to keep you on time for important events, and even can be used in place of an alarm clock. You can also have a specific image appear on the monitor screen when the alarm time is reached.
- **Album Function**
HTML files are generated automatically to create an album of recorded images. Album contents can be viewed and printed using a standard Web browser. Images can also be incorporated into Web pages quickly and easily.
- **Calendar screen**
A simple operation displays a full-month calendar on the camera's monitor screen. Each day of the full-month calendar shows a thumbnail of the first image recorded for that date, which helps to make searching for a particular image quicker and easier.
- **DCF Data Storage**
DCF (Design rule for Camera File system) data storage protocol provides image inter-compatibility between the digital camera and printers.
- **Digital Print Order Format (DPOF)**
Images can be printed easily in the sequence you want using a DPOF compatible printer. DPOF can also be used when specifying images and quantities for printing by professional print services.
- **PRINT Image Matching II Compatible**
Images include PRINT Image Matching II data (mode setting and other camera setup information). A printer that supports PRINT Image Matching II reads this data and adjusts the printed image accordingly, so your images come out just the way you intended when you recorded them.
- **USB DIRECT-PRINT support**
Your camera supports USB DIRECT-PRINT, which was developed by Seiko Epson Corporation. When connected directly to a printer that supports USB DIRECT-PRINT, you can select images to print and start the print operation directly from the camera.
- **Bundled with Photo Loader and Photohands**
Your camera comes bundled with Photo Loader, the popular application that automatically loads images from your camera to your PC. Also included is Photohands, an application that makes image retouching quick and easy.

INTRODUCTION

* EX-M20 Only

- Snapshot + Audio Mode
Adds audio to a snapshot.
- Movie + Audio Mode
- Voice Recording
Quick and easy recording of voice input.
- After Recording
Adds audio to images after they are recorded.
- Audio Player Capabilities
Use the camera to play back music data from standard MP3 (MPEG-1 Audio Layer-3/MPEG-2 Audio Layer-3) files.
- Selectable Sound Settings
You can configure different sounds to play whenever you turn on the camera, press the shutter release button, or perform a key operation.

Precautions

General Precautions

Be sure to observe the following important precautions whenever using the EX-S20/EX-M20.

All references in this manual to “this camera” and “the camera” refer to the CASIO EX-S20/EX-M20 Digital Camera.

- Never try to take pictures or use the built-in display while operating a motor vehicle or while walking. Doing so creates the danger of serious accident.
- Never try to open the case of the camera or attempt your own repairs. High-voltage internal components create the risk of electric shock when exposed. Always leave maintenance and repair work up to a CASIO authorized service center.
- Never look at the sun or any other bright light through the camera’s viewfinder. Doing so can damage your eyesight.
- Keep the small parts and accessories of this camera out of the reach of small children. If swallowed accidentally, contact your physician immediately.
- Never fire the flash in the direction of a person operating a motor vehicle. Doing so can interfere with the driver’s vision and create the danger of accident.

INTRODUCTION

- Never fire the flash while it is too close to the subject's eyes. Intense light from the flash can cause eye damage if it is fired too close to the eyes. This is especially true with young children. When using the flash, the camera should be at least one meter (3.3') from the eyes of the subject.
- Keep the camera away from water and other liquids, and never let it get wet. Moisture creates the danger of fire and electric shock. Never use the camera outdoors in the rain or snow, at the seashore or beach, in the bathroom, etc.
- Should foreign matter or water ever get into the camera, immediately turn it off. Next, remove the camera's battery and/or unplug the AC adaptor power cord from the power outlet, and contact your dealer or nearest CASIO authorized service center. Using the camera under these conditions creates the danger of fire and electric shock.
- Should you ever notice smoke or a strange odor coming out of the camera, immediately turn it off. Next, taking care you do not burn your fingers, remove the camera's battery and/or unplug the AC adaptor power cord from the power outlet, and contact your dealer or nearest CASIO authorized service center. Using the camera under these conditions creates the danger of fire and electric shock. After making sure there is no more smoke coming from the camera, take it to your nearest CASIO authorized service center for repair. Never attempt your own maintenance.
- Never use the AC adaptor to power any other device besides this camera. Never use any other AC adaptor besides the one that comes with this camera.
- Never cover the AC adaptor with a quilt, blanket, or other cover while it is in use, and do not use it near a heater.
- At least once a year, unplug the AC adaptor power cord from the power outlet and clean the area around the prongs of the plug. Dust build up around the prongs can create the danger of fire.
- If the camera's case should ever become cracked due to dropping it or otherwise subjecting it to rough treatment, immediately turn it off. Next, remove the camera's battery and/or unplug the AC adaptor power cord from the power outlet, and contact your dealer or nearest CASIO authorized service center.
- Never use the camera inside of an aircraft or in any other areas where its use is prohibited. Doing so can result in an accident.
- Physical damage and malfunction of this camera can cause the data stored in its memory to be deleted. Be sure to always keep backup copies of data by transferring them to personal computer memory.
- Never open the battery cover, disconnect the AC adaptor from the camera, or unplug the AC adaptor from the wall socket while recording images. Doing so will not only make storage of the current image impossible, it can also corrupt other image data already stored in file memory.

Data Error Precautions

- Your digital camera is manufactured using precision digital components. Any of the following creates the risk of corruption of data in file memory.
 - Removing the battery or memory card, or setting the camera onto the USB cradle while the camera is performing a record or memory access operation
 - Removing the battery, removing the memory card, or placing the camera onto the USB cradle while the operation/flash charge lamp is still flashing after you turn off the camera
 - Disconnecting the USB cable, removing the camera from the USB cradle, or disconnecting the AC adaptor from the USB cradle while a data communication operation is being performed
 - Using low battery
 - Other abnormal operations

Any of the above conditions can cause an error message to appear on the monitor screen (page 181). Follow the instructions provided by the message to eliminate the cause of the error.

Operating conditions

- This camera is designed for use in temperatures ranging from 0°C to 40°C (32°F to 104°F).
- Do not use or keep the camera in the following areas.
 - In areas subject to direct sunlight
 - In areas subject to high humidity or dust
 - Near air conditioners, heaters, or other areas subject to temperature extremes
 - Inside of a closed vehicle, especially one parked in the sun
 - In areas subject to strong vibration

Condensation

- When you bring the camera indoors on a cold day or otherwise expose it to a sudden change of temperature, there is the possibility that condensation can form on the exterior or on interior components. Condensation can cause malfunction of the camera, so you should avoid exposing it to conditions that might cause condensation.
- To keep condensation from forming, place the camera into a plastic bag before moving it into a location that is much warmer or colder than your current location. Leave it in the plastic bag until the air inside the bag has a chance to reach the same temperature as the new location. If condensation does form, remove the battery from the camera and leave the battery cover open for a few hours.

Lens

- Never apply too much force when cleaning the surface of the lens. Doing so can scratch the lens surface and cause malfunction.
- Fingerprints, dust, or any other soiling of the lens can interfere with proper image recording. Never touch the lens with your fingers. You can remove dust particles from the lens surface by using a lens blower to blow them off. Next, wipe the surface of the lens with a soft lens cloth.

Other

- Take care never to sit down with the camera in the pocket of your slacks or otherwise subject the camera to severe stress. Doing so can crack the LCD monitor screen.
- The camera may become slightly warm during use. This does not indicate malfunction.
- If the exterior of the camera needs cleaning, wipe it with a soft, dry cloth.

QUICK START GUIDE

First, charge the battery!

1. Load the battery (page 26).

1

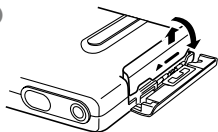

2

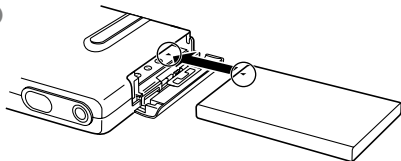

3

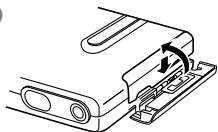

2. Place the camera onto the USB cradle to charge the battery (page 28).

- It takes about two hours to achieve a full charge.

1

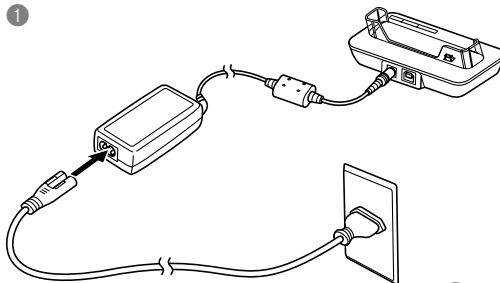

2

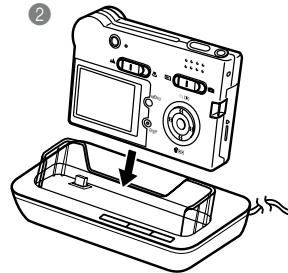

To configure display language and clock settings

▶▶ IMPORTANT! ◀◀

- Be sure to configure the following settings before using the camera to record images (See page 40 for details).

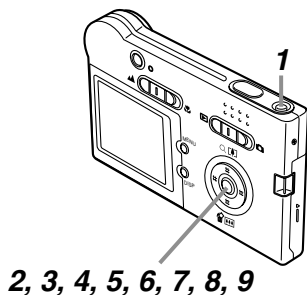

1. Press the power button to turn on the camera.
2. Press [▲], [▼], [◀], and [▶] to select the language you want.
3. Press [SET] to register the language setting.
4. Use [▲], [▼], [◀], and [▶] to select the geographical area you want, and then press [SET].
5. Use [▲] and [▼] to select the city you want, and then press [SET].
6. Use [▲] and [▼] to select the summer time (DST) setting you want, and then press [SET].
7. Use [▲] and [▼] to select the date format setting you want, and then press [SET].
8. Set the date and the time.
9. Press [SET] to register the clock settings and exit the setting screen.

To record an image

(See page 44 for details.)

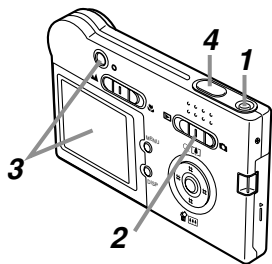

1. Press the power button to turn on the camera.
2. Align the mode selector with “” (REC).
3. Point the camera at the subject, use the monitor screen or viewfinder to compose the image.
4. Holding the camera still, gently press the shutter release button.

To view a recorded image

(See page 78 for details.)

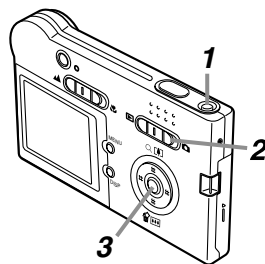

1. Press the power button to turn on the camera.
2. Align the mode selector with “” (PLAY).
3. Use [◀] and [▶] to scroll through the images on the monitor screen.

To delete an image

(See page 97 for details.)

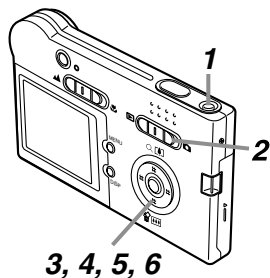

1. Press the power button to turn on the camera.
2. Align the mode selector with “▶” (PLAY).
3. Press [▼] (⏏).
4. Use [◀] and [▶] to display the image you want to delete.
5. Use [▲] and [▼] to select “Delete”.
 - To exit the image delete operation without deleting anything, select “Cancel”.
6. Press [SET] to delete the image.

GETTING READY

This section contains information about things you need to know about and do before trying to use the camera.

About This Manual

This section contains information about the conventions used in this manual.

Terminology

The following table defines the terminology used in this manual.

This term as used in this manual:	Means this:
"this camera" or "the camera"	The CASIO EX-S20/EX-M20 Digital Camera
"file memory"	The location where the camera is currently storing images you record (page 44)
"battery"	The NP-20 Rechargeable Lithium Ion Battery
"optional charger unit"	The optionally available CASIO BC-10L Charger Unit

Button Operations

Button operations are indicated by the button name inside of brackets ([]).

On-screen Text

On-screen text is always enclosed by double quotation marks (" ").

File Memory

The term "file memory" in this manual is a general term that refers to the location where your camera is currently storing the images you record. File memory can be any one of the following three locations.

- The camera's built-in Flash memory
- An SD memory card loaded in the camera
- A MultiMediaCard loaded in the camera

For more information about how the camera stores images, see page 99.

General Guide

The following illustrations show the names of each component, button, and switch on the camera.

- All the illustrations in this manual show the EX-M20. See the text that accompanies the illustrations for information about how the EX-S20 and EX-M20 differ from each other.

Camera

■ Front

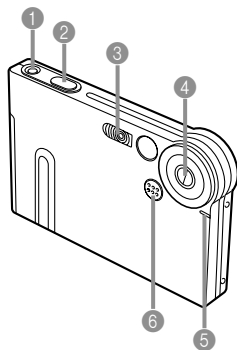

- ① Power button
- ② Shutter release button
- ③ Flash
- ④ Lens
- ⑤ Self-timer lamp
- ⑥ Microphone (EX-M20 only)

■ Back

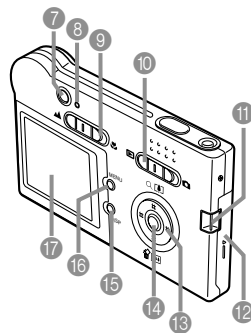

- ⑦ Viewfinder
- ⑧ Operation/Flash charge lamp
- ⑨ Normal (▲) / Macro (▼) selector
- ⑩ Mode selector
- ⑪ Strap bar
- ⑫ Battery cover
- ⑬ [▲][▼][◀][▶]
- ⑭ [SET] button
- ⑮ [DISP] button
- ⑯ [MENU] button
- ⑰ Monitor Screen

Bottom

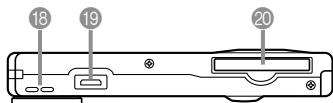

- 18 Speaker (EX-M20 only)
- 19 Connector
- 20 Memory card slot

USB Cradle

Simply placing your CASIO digital camera onto the USB cradle lets you perform the following tasks.

- Battery charging (page 28)
- Automatic transfer of images to a computer (page 131)
- Viewing of images using the Photo Stand slideshow feature (page 90).

Front

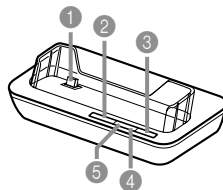

- 1 Camera connector
- 2 [PHOTO] button
- 3 [USB] button
- 4 [USB] lamp
- 5 [CHARGE] lamp

Back

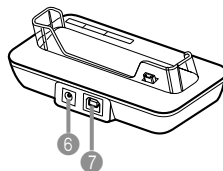

- 6 [DC IN 5.3V]
(AC adaptor connector)
- 7 [USB]
(USB port)

NOTE

- See "Using the Camera as an Audio Player" on page 161 for information about the LCD remote controller that comes with the EX-M20.

Monitor Screen Contents

The monitor screen uses various indicators and icons to keep you informed of the camera's status.

REC mode

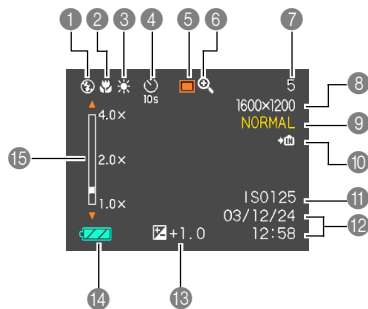



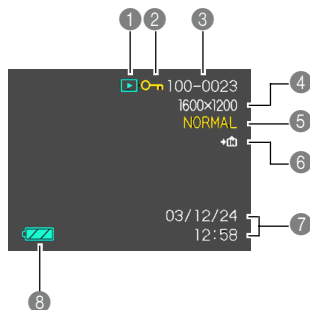

- Flash Mode indicator**
 None Auto
 Flash Off
 Flash On
 Red-eye reduction
- Focus Mode indicator**
 None Normal
 Macro
- White balance indicator**
 None Auto
 Sunlight
 Shade
 Light Bulb
 Fluorescent
 MWB Manual
- Self-timer**
 None 1-Image
 Self-timer 10 sec
 Self-timer 2 sec
 Triple self-timer
- REC modes**
 Snapshot
 BESTSHOT
 Movie
 Snapshot Audio (EX-M20 only)
 Voice Recording (EX-M20 only)
- Digital zoom indicator**
- Memory capacity**
 (Remaining number of storable images)
- Image size**
 1600 × 1200 pixels
 1600 × 1072 pixels
 1280 × 960 pixels
 640 × 480 pixels
 Movie Recording: recording time (seconds)
- Quality**
 FINE
 NORMAL
 ECONOMY
- Built-in memory selected for data storage.**
Memory card selected for data storage.
- ISO sensitivity**
- Date and time**
- EV value**
- Battery capacity**
- Digital zoom factor**

PLAY mode



① PLAY mode file type

-  Snapshot
-  Movie
-  Snapshot Audio (EX-M20 only)
-  Voice Recording (EX-M20 only)

② Image protection indicator



③ Folder number/File number

④ Image size

- 1600 × 1200 pixels
- 1600 × 1072 pixels
- 1280 × 960 pixels
- 640 × 480 pixels

⑤ Quality

- FINE
- NORMAL
- ECONOMY

- ⑥  Built-in memory selected for data storage.
-  Memory card selected for data storage.

⑦ Date and time

⑧ Battery capacity

▶▶ IMPORTANT! ◀◀

- Some information may not display properly if you display an image that was recorded using a different digital camera model.

Changing the Contents of the Monitor Screen

Each press of the [DISP] button changes the contents of the monitor screen as shown below.

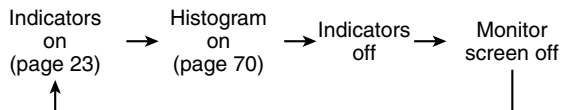

▶▶ IMPORTANT! ◀◀

- You cannot turn off the monitor screen in the following cases:
In the PLAY mode, in the BESTSHOT mode, when not recording in the Movie mode
- You cannot use the [DISP] button to change the contents of the monitor screen while a movie is being recorded, or while standing by for or performing audio recording.
- In the Voice Recording mode, you can only turn indicators on and off.

Indicator Lamps

You can find out the operational status of the camera and the USB cradle at a glance by checking the color of the indicator lamps, and whether a lamp is lit or flashing. For details, see “Indicator Lamp Reference” on page 175.

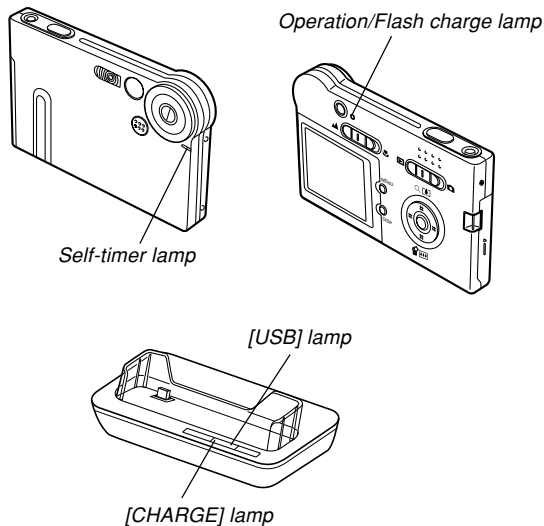

Attaching the Strap

Attach the strap to the strap bar as shown in the illustration.

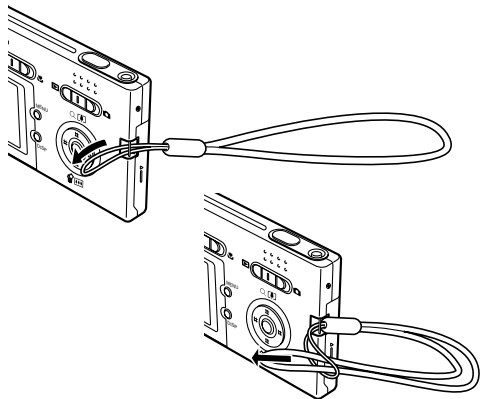

►► IMPORTANT! ◀◀

- Be sure to keep the strap around your wrist when using the camera to protect against accidentally dropping it.
- The supplied strap is intended for use with this camera only. Do not use it for any other purpose.
- Never swing the camera around by the strap.

Power Requirements

Your camera is powered by a rechargeable lithium ion battery (NP-20).

To load the battery

1. Pressing the battery cover on the side of the camera, slide it in the direction indicated by the ▲ mark and then swing it open.

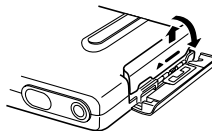

2. Align the arrow mark on the battery with the arrow mark on the camera as shown in the illustration, and slide the battery into the battery compartment.

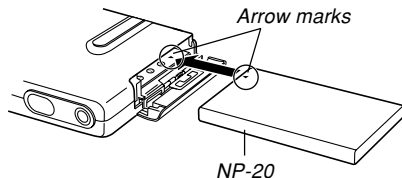

3. Swing the battery cover closed, and then slide it in the direction indicated by the arrow while pressing down on it.

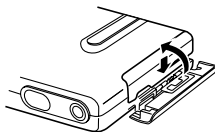

▶▶ IMPORTANT! ◀◀

- Use only the special NP-20 rechargeable lithium ion battery to power this camera. Use of any other type of battery is not supported.

▶▶ NOTE ◀◀

- To remove the battery, open the battery cover. Taking care that the battery does not suddenly fall out of the camera, tilt the camera towards the side. When the battery slides out part way, pull it out by hand.

The battery is not charged when you purchase the camera. You need to charge the battery before using the camera for the first time.

To charge the battery

1. Connect the AC power cord to the bundled AC adaptor.
2. Plug the other end of the AC power cord into a household power outlet.
3. Connect the AC adaptor to the [DC IN 5.3V] connector of the USB cradle.

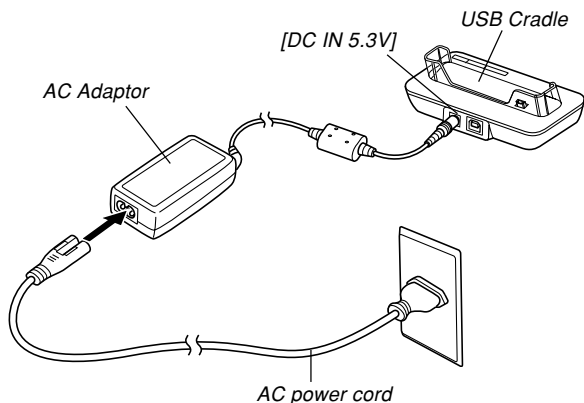

4. Turn off the camera.

5. Set the camera onto the USB cradle.

- Do not place the camera onto the USB cradle while it is turned on.
- The [CHARGE] lamp on the USB cradle should turn red, indicating that charging has started. When charging is complete, the [CHARGE] lamp will turn green.

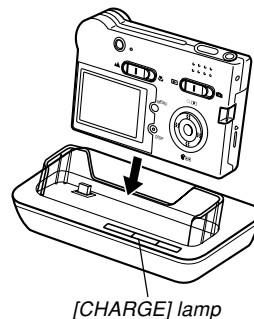

6. After charging is complete, remove the camera from the USB cradle.

- While holding the USB cradle in one hand, use your other hand to lift the left side from the USB cradle first (as if you were rotating it clockwise vertically). This ensures that you properly disengage the connector on the bottom of the camera from the USB cradle's connector.

»» IMPORTANT! ««

- It takes about two hours to achieve a full charge. Actual charging time depends on current battery capacity and charging conditions.
- Use only the USB cradle (CA-23) or the optionally available charger unit (BC-10L) to charge the special NP-20 rechargeable lithium ion battery. Never use any other charging device.
- Use only the bundled AC adaptor. Never use any other type of AC adaptor. Do not use optionally available AD-C40, AD-C620 and AD-C630 AC adaptors with this camera.
- Make sure that the camera connector of the USB cradle is securely inserted into the camera's connector as far as it will go.
- The [CHARGE] lamp may remain amber colored and the charge operation may not start right away if you try to charge immediately after using the camera (which causes battery to become warm) or when it is too hot or too cold where you are performing the charge operation. If this happens, simply wait until the battery reaches normal temperature. The [CHARGE] lamp will turn red and charging will start when the battery temperature returns to the allowable charging temperature range.

- If the [CHARGE] lamp starts flashing red, it means that an error occurs while charging. An error can be caused by any of the following: a problem with the USB cradle, a problem with the camera, or a problem with the battery or how it is loaded. Remove the camera from the USB cradle and see if it works normally.
- You can use the USB cradle to charge the camera's battery, to exchange data with a computer over a USB connection, or when using the Photo Stand feature only.

»» NOTE ««

- The bundled AC adaptor is designed for operation with any power supply in the range of 100V to 240V AC. Note, however, that the shape of the AC power cord plug varies according to country or geographic area. If you plan to use the AC adaptor in a geographic area where the power receptacle shape is different from that in your area, replace the AC power cord with one of the other ones that comes with the camera, or purchase a commercially available AC power cord that is compatible with the power outlets in that area.

■ If the camera works normally

1. Continue using the camera until the current charge is used up, and then charge the battery.

■ If the camera does not work normally

This can mean there is a problem with how the battery is loaded.

1. Remove the battery from the camera and check the battery contacts for dirt. If the contacts are dirty, wipe them clean with a dry cloth.
2. Check to make sure that the AC adaptor's power cord is connected securely to the power outlet and USB cradle.
 - If the same symptoms occur again when you place the camera on the USB cradle after taking the above steps, contact a CASIO authorized service center.

■ Battery Life Guidelines

The battery life guideline values given below indicate the amount of time under the conditions defined below the table, until power automatically turns off due to battery failure. They do not guarantee that the battery will provide the amount of service indicated. Low temperatures and continued use reduce battery life.

Operation	Approximate Battery Life
Number of Shots, Continuous Recording* ¹ (Recording Time)	720 shots (120 minutes)
Number of Shots, Normal Recording* ² (Recording Time)	190 shots (95 minutes)
Continuous Playback* ³ (Continuous Snapshot Recording)	180 minutes
Continuous Voice Recording* ⁴	170 minutes
Continuous Audio Playback* ⁵	450 minutes

Supported Battery: NP-20 (Rated Capacitance: 680mAh)

*1 Continuous Recording Conditions

- Temperature: 23°C (73°F)
- Monitor screen: On
- Flash: Off
- Image recorded about every 10 seconds

GETTING READY

*2 Normal Recording Conditions

- Temperature: 23°C (73°F)
- Monitor screen: On
- Flash: On (one flash every two shots)
- Image recorded about every 30 seconds
- Power off/on every 10 shots

*3 Continuous Playback Conditions

- Temperature: 23°C (73°F)
- Scroll one image about every 10 seconds

*4 Voice recording times are based on continuous recording.



*5 Audio playback times are based on continuous output (through headphones).





- Voice recording and audio playback times apply to the EX-M20 only.
- The above values are based on a new battery starting from a full charge. Repeated charging shortens battery life.
- Battery life is greatly affected by how much you use flash, zoom and other functions, and how long you leave power turned on.

■ Tip to Make the Battery Last Longer

- If you do not need the flash while recording, select  (flash off) for the flash mode. See page 47 for more information.
- You can also conserve battery power by using the [DISP] button to turn off the monitor screen.

■ Low Battery Indicator

The following shows how the battery capacity indicator on the monitor screen changes as battery power is used. The  indicator means that remaining battery power is low. Note that you will not be able to record images while the battery indicator is . Charge the battery immediately whenever either of these indicators appears.

Battery Level	High ←————→ Low
Indicator	 →  →  → 

Power Supply Precautions

Note the following precautions when handling or using the battery and the optional charger unit.

■ Battery Handling Precautions

● SAFETY PRECAUTIONS

Be sure to read the following Safety Precautions before trying to use the battery for the first time. Keep these safety precautions and all operating instructions on hand for future reference.

))) NOTES (((

- The term “battery” in this manual refers to the CASIO NP-20 Rechargeable Lithium Ion Battery.
- The term “optional charger unit” in the following precautions refers to the optionally available CASIO BC-10L Charger Unit.

- Failure to observe any of the following precautions while using the battery creates the risk of over-heating, fire, and explosion.
 - Never use any other type of charger except the optional charger unit specified for the battery.
 - Never try to use the battery to power any other device other than this camera.
 - Never use or leave the battery near open flame.
 - Never place the battery in a microwave oven, throw it into fire, or otherwise expose it to intense heat.
 - Make sure the battery is oriented correctly when you load it into the camera or attach it to the optional charger unit.
 - Never carry or store the battery together with items that can conduct electricity (necklaces, pencil lead, etc.)
 - Never try to take the battery apart, modify it in any way, or expose it to strong impact.
 - Do not immerse the battery in fresh water or salt water.
 - Do not use or leave the battery under direct sunlight, in an automobile parked in the sun, or in any other area subject to high temperatures.

GETTING READY

- Should you ever notice leakage, strange odor, heat generation, discoloration, deformation, or any other abnormal condition while using, charging, or storing a battery, immediately remove it from the camera or optional charger unit and keep it away from open flame.
- If the battery does not achieve full charge after the normal charging time has passed, stop charging. Continued charging creates the risk of overheating, fire, and explosion.
- Battery fluid can damage your eyes. Should battery fluid get into your eyes accidentally, immediately rinse them with clean tap water and then consult a physician.
- Be sure to read page 28 of this User's Guide and the instructions that come with the optional charger unit before using or charging the battery.
- If the battery is to be used by young children, make sure that a responsible adult makes them aware of the precautions and proper handling instructions and make sure that they handle the battery correctly.
- Should fluid from the battery accidentally get onto clothing or your skin, immediately rinse it off with clean tap water. Prolonged contact with battery fluid can cause skin irritation.

● PRECAUTIONS DURING USE

- The battery is designed for use with this CASIO digital camera only.
- Use only the USB cradle that comes with the camera or the specified optional charger unit to charge the battery. Never use any other type of charger unit for charging.
- A new battery is not charged. Be sure to charge the battery before using it for the first time.
- Use of a battery in cold environments shortens the operating time you can expect on a full charge. Charge the battery in a location where the temperature is in the range of 10°C to 35°C (50°F to 95°F). Charging outside this temperature range can cause charging to take longer than normal or even cause charging to fail.
- Very limited operation following a full charge indicates that the battery has reached the end of its service life. Replace the battery with a new one.
- Never wipe the battery with thinner, benzene, alcohol, or other volatile agents or chemically treated rags. Doing so can cause deformation of the battery and lead to malfunction.

● BATTERY STORAGE PRECAUTIONS

- Make sure you remove the battery when you do not plan to use the camera for a long time. A battery left in the camera discharges very small amounts of power even when power is turned off, which can lead to a dead battery or the need for longer charging before the next use.
- Store the battery in a cool, dry place (20°C (68°F) or lower).

● USING THE BATTERY

- See page 28 of this manual or the instructions that come with the optional charger unit for information about charging procedures and charging times.
- When transporting a battery, keep it either loaded in the camera or stored in its case.

■ USB Cradle and AC Adaptor Precautions



- Never use an electrical outlet whose voltage is outside the rating marked on the AC adaptor. Doing so can create the danger of fire or electric shock. Use only the bundled AC adaptor specified for this camera.
- Do not allow the AC adaptor cord to become cut or damaged, do not place heavy objects on it, and keep it away from heat. A damaged power cord creates the risk of fire and electric shock.
- Never try to modify the AC adaptor cord, or subject it to severe bending, twisting, or pulling. Doing so creates the risk of fire and electric shock.
- Never touch the AC adaptor while your hands are wet. Doing so creates the risk of electric shock.
- Do not overload extension cords or wall outlets. Doing so creates the danger of fire and electric shock.
- Should the cord of the AC adaptor become damaged (exposed internal wiring), request a replacement from a CASIO authorized service center. A damaged AC adaptor cord creates the danger of fire or electric shock.

GETTING READY



Caution!

- Use the AC adaptor where it will not be splashed with water. Water creates the risk of fire and electric shock.
- Do not place a vase or any other container filled with liquid on top of the AC adaptor. Water creates the risk of fire and electric shock.
- Make sure you always remove the camera from the USB cradle before connecting or disconnecting the AC adaptor.
- Charging, USB data communication, and using the Photo Stand feature can cause the AC adaptor to become warm. This is normal and does not indicate malfunction.
- Unplug the AC power cord from the power outlet whenever you are not using it.
- Never place a blanket or any other cover on the AC adaptor. Doing so creates the risk of fire.

Turning the Camera On and Off

Press the power button to turn the camera on and off. Pressing the power button to turn on the camera causes the operation/flash charge lamp to turn green. Press the power button again to turn off the camera.

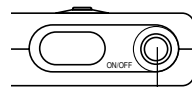



Power button

►► IMPORTANT! ◀◀

- If camera power is turned off by the Auto Power Off feature, press the power button to turn it back on again.

Auto Power Off (APO)

Auto Power Off (APO) automatically turns off the camera when you do not perform any operation for a certain amount of time.

1. Turn on the camera, and then align the mode selector with “” (REC) or “” (PLAY).
2. Press [MENU].
3. Use [◀] and [▶] to select the “Set Up” tab.
4. Use [▲] and [▼] to select “Auto Power Off”, and then press [▶].
 - See page 37 for information about how to use menus.

5. Use [▲] and [▼] to change the currently selected setting, and then press [SET].

To do this:	Select this setting:
Set the Auto Power Off trigger time to 2 minutes	2 min
Set the Auto Power Off trigger time to 5 minutes	5 min

»» IMPORTANT! ««

- Auto Power Off is automatically disabled under any one of the following conditions.
 - While the camera is connected to a computer via the USB cradle
 - While a slideshow is playing
 - While playing back a voice recording file (EX-M20 only)

Using the On-screen Menu

Pressing [MENU] displays menus on the monitor screen that you can use to perform various operations. The menu that appears depends on whether you are in the REC mode or the PLAY mode. The following shows an example menu procedure in the REC mode.

1. Turn on the camera, and then align the mode selector with “” (REC) to enter the REC mode.

- If you want to enter the PLAY mode instead, you would align the mode selector with “” (PLAY).

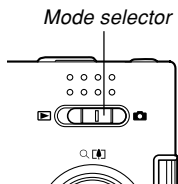

2. Press [MENU].

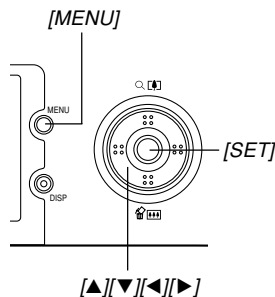

Settings

Selection cursor (indicates the currently selected item)

GETTING READY

● Menu Screen Operations

When you want to do this:	Do this:
Move between tabs	Press [◀] and [▶].
Move from the tab to the settings	Press [▼].
Move from the settings to the tab	Press [▲].
Move between the settings	Press [▲] and [▼].
Display the options available for a setting	Press [▶] or press [SET].
Select an option	Press [▲] and [▼].
Register an option selection and exit the menu screen	Press [SET].
Register an option selection and return to the menu screen	Press [◀].
Exit the menu screen	Press the [MENU] button.

3. Press [◀] or [▶] to select the tab you want, and then press [SET] to move the selection cursor from the tab to the settings.

4. Use [▲] and [▼] to select the feature whose setting you want to configure, and then press [▶].

- Instead of pressing [▶], you could also press [SET].



Example: To select the "Flash" item.

5. Use [▲] and [▼] to change the currently selected setting.

6. Perform one of the following operations to apply the setting you configured.

To do this:	Perform this key operation:
Apply the setting and exit the menu screen.	Press [SET].
Apply the setting and return to feature selection in step 4.	Press [◀].
Apply the setting and return to tab selection in step 3.	1. Press [◀]. 2. Use [▲] to move back up to tab selection.

- See “Menu Reference” on page 173 for more information about menus.

Configuring Display Language and Clock Settings

Be sure to configure the following settings before using the camera to record images.

- Display language
- Home city
- Date Style
- Date and time

Note that the current date and time settings are used by the camera to generate the date and time that are stored along with image data, etc.

▶▶ IMPORTANT! ◀◀

- The camera's clock settings are cleared whenever power is totally cut off. This can happen if the battery goes dead while the camera is not being supplied power by the USB cradle. The clock setting screen will appear automatically the next time you turn on power after the settings are cleared. Set the date and time before using the camera.
- The current date and time settings will be cleared if the battery remains dead without being charged for about two days.
- Recording images without configuring the clock settings causes incorrect time information to be registered. Be sure to configure the clock settings before using the camera.

To configure display language and clock settings

1. Press the power button to turn on the camera.
2. Use [▲], [▼], [◀], and [▶] to select the language you want, and then press [SET].



日本語	: Japanese
English	: English
Français	: French
Deutsch	: German
Español	: Spanish
Italiano	: Italian
Português	: Portuguese
中國語	: Chinese (Complex)
中国語	: Chinese (Simplified)
한국어	: Korean

GETTING READY

3. Use [▲], [▼], [◀], and [▶] to select the geographical area where you live, and then press [SET].



4. Use [▲] and [▼] to select the name of the city where you live, and then press [SET].



5. Use [▲] and [▼] to select the summer time (DST) setting you want, and then press [SET].

When you want to do this:	Select this setting:
Keep time using summer time (Daylight Saving Time)	On
Keep time using standard time	Off

6. Use [▲] and [▼] to change the date format setting, and then press [SET].

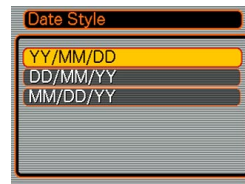

Example: December 24, 2003

To display the date like this:	Select this format:
03/12/24	YY/MM/DD
24/12/03	DD/MM/YY
12/24/03	MM/DD/YY

7. Set the current date and the time.

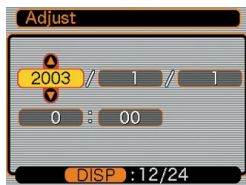

To do this:	Do this:
Change the setting at the current cursor location	Press [▲] and [▼].
Move the cursor between settings	Press [◀] and [▶].
Toggle between 12-hour and 24-hour timekeeping	Press [DISP].

8. Press [SET] to register the settings and exit the setting screen.