

EXILIM

E

Digital Camera

EX-Z4U

User's Guide

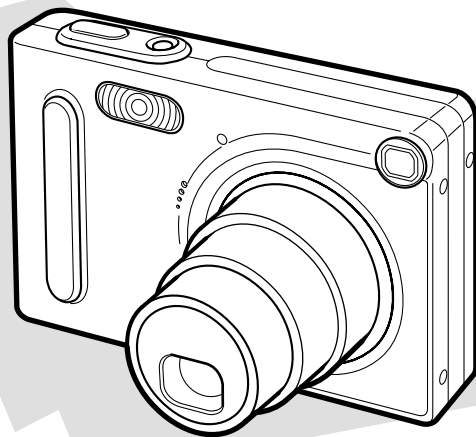

Thank you for purchasing this CASIO Product.

- Before using it, be sure to read the precautions contained in this User's Guide.
- Keep the User's Guide in a safe place for future reference.
- For the most up-to-date information about this product, visit the official Exilim Website at <http://www.exilim.com/>.

K857PCM2DMX

CASIO®

INTRODUCTION

Unpacking

Check to make sure that all of the items shown below are included with your camera. If something is missing, contact your dealer as soon as possible.



Camera

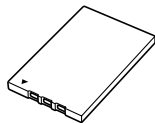

Rechargeable lithium ion battery (NP-20)

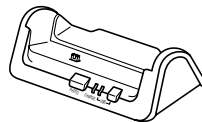

USB Cradle (CA-21A)

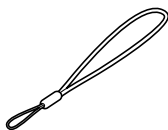

Strap



CD-ROM

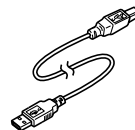

USB Cable

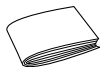

Basic Reference

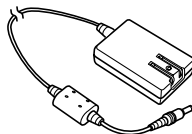

Special AC Adaptor (AD-C51J)

Contents

2 INTRODUCTION

Unpacking	2
Features	9
Precautions	11
General Precautions	11
Data Error Precautions	13
Operating conditions	13
Condensation	14
Lens	14
Other	14

15 QUICK START GUIDE

First, charge the battery!	15
To configure display language and clock settings	16
To record an image	17
To view a recorded image	17
To delete an image	18

19 GETTING READY

About This Manual	19
General Guide	20
Camera	20
USB Cradle	21
Monitor Screen Contents	22
REC mode	22
PLAY mode	24
Changing the Contents of the Monitor Screen	25
Indicator Lamps	25
Attaching the Strap	26
Power Requirements	26
To load the battery	26
To remove the battery	28
To charge the battery	28
Power Supply Precautions	32
Turning the Camera On and Off	36
Configuring Power Saving Settings	36
Using the On-screen Menus	37
Configuring Display Language and Clock Settings ...	40
To configure display language and clock settings	41

INTRODUCTION

43 BASIC IMAGE RECORDING

Recording an Image	43
Aiming the Camera	43
Recording an Image	44
Recording Precautions	46
About Auto Focus	47
About the REC Mode Monitor Screen	47
Using the Optical Viewfinder	48
Using Zoom	49
Optical Zoom	49
Digital Zoom	50
Using the Flash	51
Flash Unit Status	53
Flash Precautions	53
Using the Self-timer	54
Specifying Image Size and Quality	55
To specify the image size	55
To specify image quality	56

58 OTHER RECORDING FUNCTIONS

Selecting the Focus Mode	58
Using Auto Focus	58
Using the Macro Mode	60
Using the Pan Focus Mode	60
Using the Infinity Mode	61
Using Manual Focus	62
Using Focus Lock	63

Exposure Compensation (EV Shift)	64
Adjusting White Balance	65
Adjusting White Balance Manually	66
Using the BESTSHOT Mode	67
Creating Your Own BESTSHOT Setup	69
Combining Shots of Two People into a Single Image (Coupling Shot)	71
Recording a Subject onto an Existing Background Image (Pre-shot)	73
Recording Audio	75
Adding Audio to a Snapshot	75
Recording Your Voice	76
Using the Histogram	78
REC Mode Camera Settings	79
Specifying ISO Sensitivity	80
Turning the On-screen Grid On and Off	81
Turning Image Review On and Off	81
Assigning Functions to the [◀] and [▶] Keys	82
Specifying Power On Default Settings	83
Resetting the Camera	84

85 PLAYBACK

Basic Playback Operation	85
Playing an Audio Snapshot	86
Flipping the Display	87
Zooming the Display Image	88
Resizing an Image	89
Cropping an Image	90
Displaying the 9-image View	91
Selecting a Specific Image in the 9-image View	92
Displaying the Calendar Screen	92
Playing a Slide Show	93
To specify the slideshow images	95
To specify the slideshow time	96
To set the slideshow interval	96
Using the Photo Stand Feature	97
Rotating the Display Image	98
Using Image Roulette	99
Adding Audio to a Snapshot	100
To re-record audio	101
Playing Back a Voice Recording File	102

103 DELETING FILES

Deleting a Single File	103
Deleting All Files	104

105 FILE MANAGEMENT

Folders	105
Memory Folders and Files	105
Protecting Files	106
To protect a single file	106
To protect all files in memory	107
DPOF	107
To configure print settings for a single image	108
To configure print settings for all images	109
PRINT Image Matching II	110
Exif Print	110
Using USB DIRECT-PRINT	111
Using the FAVORITE Folder	113
To copy a file to the FAVORITE folder	113
To display a file in the FAVORITE folder	114
To delete a file from the FAVORITE folder	115
To delete all files from the FAVORITE folder	116

117 OTHER SETTINGS

Configuring Sound Settings	117
To configure sound settings	117
To set the volume level	118
Specifying an Image for the Startup Screen	118
Configuring Power Down Image Settings	119
Specifying the File Name Serial Number Generation Method	121
Using the Alarm	122
To set an alarm	122
Stopping the Alarm	123
Setting the Clock	123
To select your Home Time zone	123
To set the current time and date	124
Changing the Date Format	125
Using World Time	125
To display the World Time screen	125
To configure World Time settings	126
To configure summer time (DST) settings	127
Changing the Display Language	128
Formatting Built-in Memory	128

130 USING A MEMORY CARD

Using a Memory Card	131
To insert a memory card into the camera	131
To remove a memory card from the camera	132
Formatting a Memory Card	132
Memory Card Precautions	133
Copying Files	134
To copy all the files in built-in memory to a memory card	134
To copy a file from a memory card to built-in memory	135

136 VIEWING IMAGES ON A COMPUTER

Using the Camera with a Windows Computer	136
USB Connection Precautions	141
Using the Camera with a Macintosh Computer	141
USB Connection Precautions	145
Operations You Can Perform from Your Computer	145
Using a Memory Card to Transfer Images to a Computer	146
Memory Data	147
DCF Protocol	147
Memory Directory Structure	147
Image Files Supported by the Camera	149
Built-in Memory and Memory Card Precautions	149

150 USING THE CAMERA WITH A COMPUTER

Using the Album Feature	150
Creating an album	150
Selecting an Album Layout	151
Configuring Detailed Album Settings	152
Viewing Album Files	154
Saving an Album	157
Installing the Software from the CD-ROM	157
About the bundled CD-ROM	157
Computer System Requirements	158
Installing Software from the CD-ROM	
in Windows	159
Getting Started	159
Viewing the Contents of the "Read me" File	160
Installing an Application	160
Viewing User Documentation (PDF Files)	161
User Registration	161
Exiting the Menu Application	161
Installing Software from the CD-ROM on	
a Macintosh	162
Installing Software	162
Viewing User Documentation (PDF Files)	163

164 APPENDIX

Menu Reference	164
Indicator Lamp Reference	166
REC mode	167
PLAY mode	168
USB Cradle Indicator Lamps	168
Troubleshooting Guide	169
Display Messages	172
Specifications	173
Main Specifications	173

»» IMPORTANT! ««

- The contents of this manual are subject to change without notice.
- CASIO COMPUTER CO., LTD. assumes no responsibility for any damage or loss resulting from the use of this manual.
- CASIO COMPUTER CO., LTD. assumes no responsibility for any loss or claims by third parties which may arise through the use of the EX-Z4U.
- CASIO COMPUTER CO., LTD. shall not be held liable for any damages or losses suffered by you or any third party due to the use of Photo Loader and/or Photohands.
- CASIO COMPUTER CO., LTD. assumes no responsibility for any damage or loss caused by deletion of data as a result of malfunction, repairs, or battery replacement. Be sure to back up all important data on other media to protect against its loss.
- *The SD logo is a registered trademark.*
- *Windows, Internet Explorer, and DirectX are registered trademarks of Microsoft Corporation.*
- *Macintosh is a registered trademark of Apple Computer, Inc.*
- *MultiMediaCard is a trademark of Infineon Technologies AG of Germany, and licensed to the MultiMediaCard Association (MMCA).*
- *Acrobat and Acrobat Reader are trademarks of Adobe Systems Incorporated.*

- *The USB driver (mass storage) uses Phoenix Technologies Ltd. software.
Compatibility Software Copyright © 1997
Phoenix Technologies Ltd., All Rights Reserved.*
- *Other company, product and service names used herein may also be trademarks or service marks of others.*
- *Photo Loader and Photohands are the property of CASIO COMPUTER CO., LTD. Except as stipulated above, all copyrights and other related rights to these applications revert to CASIO COMPUTER CO., LTD.*

■ Copyright Restrictions

Except for the purposes of your own personal enjoyment, unauthorized copying of snapshot files and audio files violates copyright laws and international contracts. Distribution to third parties of such files over the Internet without permission of the copyright holder, whether for profit or for free, violates copyright laws and international contracts.

Features

- **4.0 million Effective Pixels**
A high-resolution megapixel CCD provides 4.0 million effective pixels (4.23 million total pixels) for images that print beautifully.
- **2.0-inch TFT color LCD monitor screen**
- **12X seamless zoom**
3X optical zoom, 4X digital zoom
- **10MB Flash memory**
Images can be recorded without using a memory card.
- **Multi Auto Focus**
When “Multi” is selected for the Auto Focus area, the camera takes simultaneous meter readings at seven different points and automatically selects the best one. This makes it possible to avoid erroneous focusing on the background, and ensure proper focus for a wide range of image types.
- **Pan Focus**
This feature lets you lock the focus point and ensures that you do not miss that special moment when it happens.
- **Support for SD memory cards and MMC (MultiMedia Cards) for memory expansion**
- **Easy Charging**
Just place the camera onto the USB cradle to charge its battery.
- **Easy Image Transfer**
Transfer images to a computer simply by placing the camera onto the USB cradle.
- **Photo Stand feature**
A slideshow of images in file memory can be played while the camera is on its USB cradle.
- **BESTSHOT**
Simply select the sample scene that matches the type of image you are trying to record and the camera performs troublesome setups automatically for beautiful pictures every time.
- **Coupling Shot and Pre-shot**
Coupling Shot lets you combine two subjects into a single image, while Pre-shot lets you add a subject to a previously recorded background image. This means you can create images that include you and your friend, even if you are the only two people around. You can use Coupling Shot and Pre-shot by selecting the applicable sample images in the BESTSHOT mode.
- **Image Roulette Feature**
Images cycle like a slot machine on the display until one of them remains.
- **Triple Self-timer mode**
The self-timer can be set up to repeat three times, automatically.

INTRODUCTION

- **Real-time histogram**
An on-screen histogram lets you adjust exposure as you view the effect on overall image brightness, which makes shooting under difficult lighting conditions easier than ever before.
- **World Time**
A simple operation sets the current time for your current location. You can select from among 162 cities in 32 time zones.
- **Alarm**
A built-in alarm helps to keep you on time for important events, and even can be used in place of an alarm clock. You can also have a specific image appear, or an audio file to play when the alarm time is reached.
- **Album Function**
HTML files are generated automatically to create an album of recorded images. Album contents can be viewed and printed using a standard Web browser. Images can also be incorporated into Web pages quickly and easily.
- **Calendar screen**
A simple operation displays a full-month calendar on the camera's monitor screen. Each day of the full-month calendar shows a thumbnail of the first image recorded for that date, which helps to make searching for a particular image quicker and easier.
- **Snapshot + Audio Mode**
Adds audio to a snapshot.
- **Voice Recording**
Quick and easy recording of voice input.
- **After Recording**
Adds audio to images after they are recorded.
- **Selectable Sound Settings**
You can configure different sounds to play whenever you turn on the camera, press the shutter release button half-way or all the way, or perform a key operation.
- **DCF Data Storage**
DCF (Design rule for Camera File system) data storage protocol provides image inter-compatibility between the digital camera and printers.
- **Digital Print Order Format (DPOF)**
Images can be printed easily in the sequence you want using a DPOF compatible printer. DPOF can also be used when specifying images and quantities for printing by professional print services.
- **PRINT Image Matching II Compatible**
Images include PRINT Image Matching II data (mode setting and other camera setup information). A printer that supports PRINT Image Matching II reads this data and adjusts the printed image accordingly, so your images come out just the way you intended when you recorded them.

INTRODUCTION

- **USB DIRECT-PRINT support**
Your camera supports USB DIRECT-PRINT, which was developed by Seiko Epson Corporation. When connected directly to a printer that supports USB DIRECT-PRINT, you can select images to print and start the print operation directly from the camera.
- **Bundled with Photo Loader and Photohands**
Your camera comes bundled with Photo Loader, the popular application that automatically loads images from your camera to your PC. It also comes with Photohands, and application that makes image retouching quick and easy.

Precautions

General Precautions

Be sure to observe the following important precautions whenever using the EX-Z4U.

All references in this manual to “this camera” and “the camera” refer to the CASIO EX-Z4U Digital Camera.

- Never try to take pictures or use the built-in display while operating a motor vehicle or while walking. Doing so creates the danger of serious accident.
- Never try to open the case of the camera or attempt your own repairs. High-voltage internal components create the risk of electric shock when exposed. Always leave maintenance and repair work up to a CASIO authorized service center.
- Never look at the sun or any other bright light through the camera’s viewfinder. Doing so can damage your eyesight.
- Keep the small parts and accessories of this camera out of the reach of small children. If swallowed accidentally, contact your physician immediately.
- Never fire the flash in the direction of a person operating a motor vehicle. Doing so can interfere with the driver’s vision and create the danger of accident.

INTRODUCTION

- Never fire the flash while it is too close to the subject's eyes. Intense light from the flash can cause eye damage if it is fired too close to the eyes. This is especially true with young children. When using the flash, the camera should be at least one meter (3.3') from the eyes of the subject.
- Keep the camera away from water and other liquids, and never let it get wet. Moisture creates the danger of fire and electric shock. Never use the camera outdoors in the rain or snow, at the seashore or beach, in the bathroom, etc.
- Should foreign matter or water ever get into the camera, immediately turn it off. Next, remove the camera's battery and/or unplug the AC adaptor power cord from the power outlet, and contact your dealer or nearest CASIO authorized service center. Using the camera under these conditions creates the danger of fire and electric shock.
- Should you ever notice smoke or a strange odor coming out of the camera, immediately turn it off. Next, taking care you do not burn your fingers, remove the camera's battery and/or unplug the AC adaptor power cord from the power outlet, and contact your dealer or nearest CASIO authorized service center. Using the camera under these conditions creates the danger of fire and electric shock. After making sure there is no more smoke coming from the camera, take it to your nearest CASIO authorized service center for repair. Never attempt your own maintenance.
- Never use the AC adaptor to power any other device besides this camera. Never use any other AC adaptor besides the one that comes with this camera.
- Never cover the AC adaptor with a quilt, blanket, or other cover while it is in use, and do not use it near a heater.
- At least once a year, unplug the AC adaptor power cord from the power outlet and clean the area around the prongs of the plug. Dust build up around the prongs can create the danger of fire.
- If the camera's case should ever become cracked due to dropping it or otherwise subjecting it to rough treatment, immediately turn it off. Next, remove the camera's battery and/or unplug the AC adaptor power cord from the power outlet, and contact your dealer or nearest CASIO authorized service center.
- Never use the camera inside of an aircraft or in any other areas where its use is prohibited. Doing so can result in an accident.
- Physical damage and malfunction of this camera can cause the data stored in its memory to be deleted. Be sure to always keep backup copies of data by transferring them to personal computer memory.
- Never open the battery compartment cover, disconnect the AC adaptor from the camera, or unplug the AC adaptor from the wall socket while recording images. Doing so will not only make storage of the current image impossible, it can also corrupt other image data already stored in file memory.

Data Error Precautions

- Your digital camera is manufactured using precision digital components. Any of the following creates the risk of corruption of data in file memory.
 - Removing the battery or memory card, or setting the camera onto the USB cradle while the camera is performing a record or memory access operation
 - Removing the battery, removing the memory card, or placing the camera onto the USB cradle while the operation lamp is still flashing after you turn off the camera
 - Disconnecting the USB cable, removing the camera from the USB cradle, or disconnecting the AC adaptor from the USB cradle while a data communication operation is being performed
 - Low battery power
 - Other abnormal operations

Any of the above conditions can cause an error message to appear on the monitor screen (page 172). Follow the instructions provided by the message to eliminate the cause of the error.

Operating conditions

- This camera is designed for use in temperatures ranging from 0°C to 40°C (32°F to 104°F).
- Do not use or keep the camera in the following areas.
 - In areas subject to direct sunlight
 - In areas subject to high humidity or dust
 - Near air conditioners, heaters, or other areas subject to temperature extremes
 - Inside of a closed vehicle, especially one parked in the sun
 - In areas subject to strong vibration

Condensation

- When you bring the camera indoors on a cold day or otherwise expose it to a sudden change of temperature, there is the possibility that condensation can form on the exterior or on interior components. Condensation can cause malfunction of the camera, so you should avoid exposing it to conditions that might cause condensation.
- To keep condensation from forming, place the camera into a plastic bag before moving it into a location that is much warmer or colder than your current location. Leave it in the plastic bag until the air inside the bag has a chance to reach the same temperature as the new location. If condensation does form, remove the battery from the camera and leave the battery compartment cover open for a few hours.

Lens

- Never apply too much force when cleaning the surface of the lens. Doing so can scratch the lens surface and cause malfunction.
- Fingerprints, dust, or any other soiling of the lens can interfere with proper image recording. Never touch the lens with your fingers. You can remove dust particles from the lens surface by using a lens blower to blow them off. Next, wipe the surface of the lens with a soft lens cloth.

Other

- The camera may become slightly warm during use. This does not indicate malfunction.
- If the exterior of the camera needs cleaning, wipe it with a soft, dry cloth.

QUICK START GUIDE

First, charge the battery!

1. Load the battery (page 26).

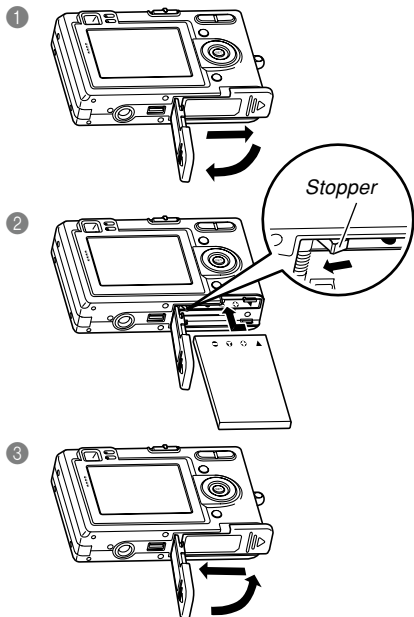

2. Place the camera onto the USB cradle to charge the battery (page 28).

- It takes about two hours to achieve a full charge.

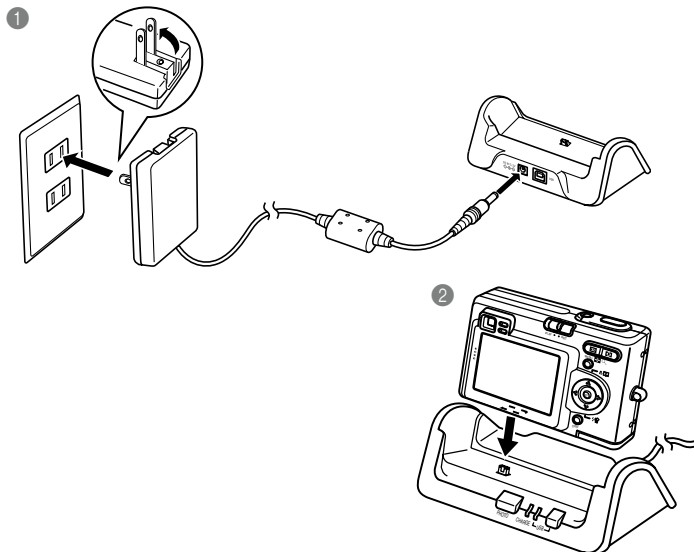

To configure display language and clock settings

- Be sure to configure the following settings before using the camera to record images. (See page 40 for details.)

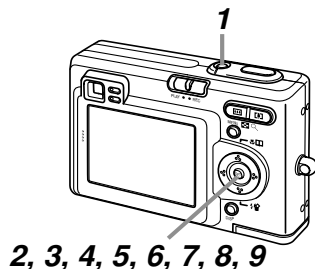

1. Press the power button to turn on the camera.
2. Press [▲] to select the language you want.
3. Press [SET] to register the language setting.
4. Use [▲], [▼], [◀], and [▶] to select the geographical area you want, and then press [SET].
5. Use [▲] and [▼] to select the city you want, and then press [SET].
6. Use [▲] and [▼] to select the summer time (DST) setting you want, and then press [SET].
7. Use [▲] and [▼] to select the date format setting you want, and then press [SET].
8. Set the date and the time.
9. Press [SET] to register the clock settings and exit the setting screen.

To record an image

(See page 43 for details.)

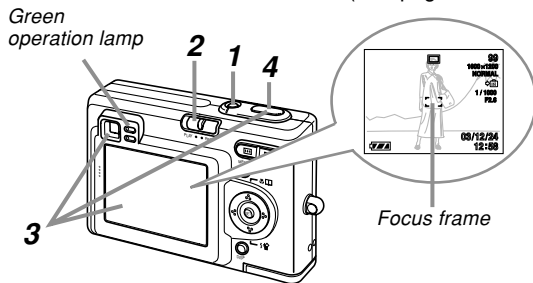

1. Press the power button to turn on the camera.
2. Align the mode selector with “REC”.
3. Point the camera at the subject, use the monitor screen or viewfinder to compose the image, and then press the shutter release button half way.
 - When proper focus is achieved, the focus frame turns green and the green operation lamp lights.
4. Holding the camera still, gently press the shutter release button.

To view a recorded image

(See page 85 for details.)

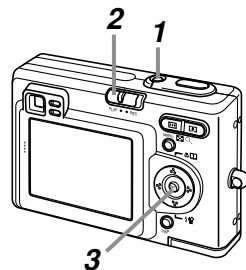

1. Press the power button to turn on the camera.
2. Align the mode selector with “PLAY”.
3. Use [◀] and [▶] to scroll through the images.

To delete an image

(See page 103 for details.)

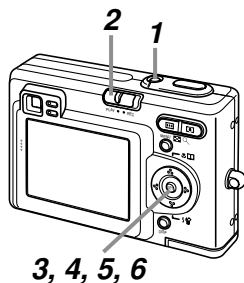

- 1. Press the power button to turn on the camera.**
- 2. Align the mode selector with “PLAY”.**
- 3. Press [▼] (⚡🗑).**
- 4. Use [◀] and [▶] to display the image you want to delete.**
- 5. Use [▲] and [▼] to select “Delete”.**
 - To exit the image delete operation without deleting anything, select “Cancel”.
- 6. Press [SET] to delete the image.**

GETTING READY

This section contains information about things you need to know about and do before trying to use the camera.

About This Manual

This section contains information about the conventions used in this manual.

Terminology

The following table defines the terminology used in this manual.

This term as used in this manual:	Means this:
"this camera" or "the camera"	The CASIO EX-Z4U Digital Camera
"file memory"	The location where the camera is currently storing images you record (page 44)
"battery"	The NP-20 Rechargeable Lithium Ion Battery
"optional charger unit"	The optionally available CASIO BC-10L Charger Unit

Button Operations

Button operations are indicated by the button name inside of brackets ([]).

On-screen Text

On-screen text is always enclosed by double quotation marks (" ").

File Memory

The term "file memory" in this manual is a general term that refers to the location where your camera is currently storing the images you record. File memory can be any one of the following three locations.

- The camera's built-in Flash memory
- An SD memory card loaded in the camera
- A MultiMediaCard loaded in the camera

For more information about how the camera stores images, see page 130.

General Guide

The following illustrations show the names of each component, button, and switch on the camera.

Camera

■ Front

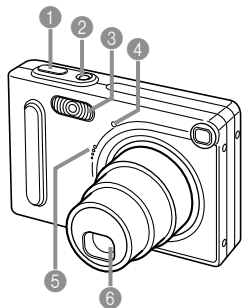

- ① Shutter release button
- ② Power button
- ③ Flash
- ④ Self-timer lamp
- ⑤ Microphone
- ⑥ Lens

■ Back

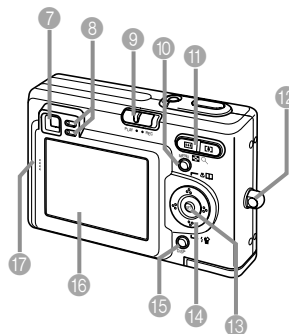

- ⑦ Viewfinder
- ⑧ Operation lamp
- ⑨ Mode selector
- ⑩ [MENU] button
- ⑪ Zoom button
- ⑫ Strap ring
- ⑬ [SET] button
- ⑭ [▲][▼][◀][▶]
- ⑮ [DISP] button
- ⑯ Monitor Screen
- ⑰ Speaker

Bottom

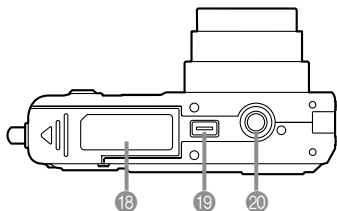

18 Battery compartment cover

19 Connector

20 Tripod screw hole

* Use this hole when attaching to a tripod.

21 Stopper

22 Battery compartment

23 Memory card slot

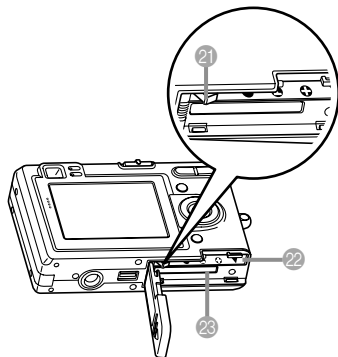

USB Cradle

Simply placing your CASIO digital camera onto the USB cradle lets you perform the following tasks.

- Battery charging (page 28)
- Automatic transfer of images to a computer (page 136)
- Viewing of images using the Photo Stand slideshow feature (page 97).

Front

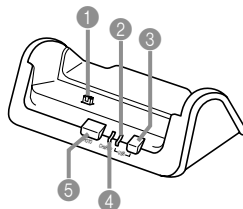

1 Camera connector

2 [USB] lamp

3 [USB] button

4 [CHARGE] lamp

5 [PHOTO] button

Back

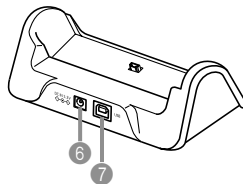

6 [DC IN 5.3V]

(AC adaptor connector)

7 [USB]

(USB port)

Monitor Screen Contents

The monitor screen uses various indicators and icons to keep you informed of the camera's status.

REC mode

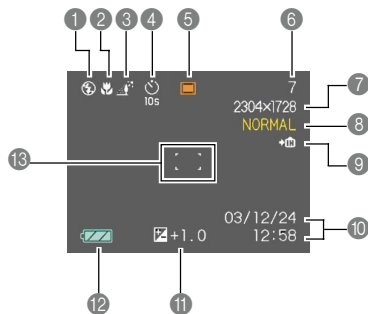

1 Flash Mode indicator

- None Auto
- Flash Off
 - Flash On
 - Red-eye reduction

- If the camera detects that flash is required while auto flash is selected, the flash on indicator will appear when the shutter release button is pressed half way.

2 Focus Mode indicator

- None Auto Focus
- Macro
 - Pan Focus
 - Infinity
 - Manual Focus

3 White balance indicator

- None Auto
- Sunlight
 - Shade
 - Light Bulb
 - Fluorescent
 - Manual

4 Self-timer

- None 1-Image
- Self-timer 10 sec
 - Self-timer 2 sec
 - Triple self-timer

5 REC modes

- Snapshot
- BESTSHOT
- Snapshot Audio
- Voice Recording

6 Memory capacity

(Remaining number of storable images)

7 Image size

- 2304 × 1728 pixels
- 2304 × 1536 (3:2) pixels
- 1600 × 1200 pixels
- 1280 × 960 pixels
- 640 × 480 pixels

8 Quality

- FINE
- NORMAL
- ECONOMY

- 9 Built-in memory selected for data storage.
 Memory card selected for data storage.

10 Date and time

11 EV value

12 Battery capacity

13 Focus frame

- Focusing complete: Green
- Focusing failed: Red

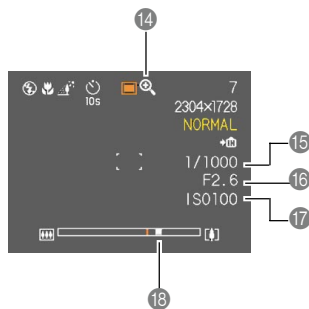

14 Digital zoom indicator

15 Shutter speed value

- An out of range aperture or shutter speed causes the corresponding monitor screen value to turn amber.

16 Aperture value

17 ISO sensitivity



18 Zoom indicator

- Left side indicates optical zoom.
- Right side indicates digital zoom.

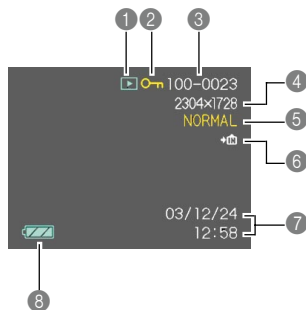
PLAY mode



1 PLAY mode file type

-  Snapshot
-  Snapshot Audio
-  Voice Recording

2 Image protection indicator



3 Folder number/File number

4 Image size

- 2304 × 1728 pixels
- 2304 × 1536 (3:2) pixels
- 1600 × 1200 pixels
- 1280 × 960 pixels
- 640 × 480 pixels

5 Quality

- FINE
- NORMAL
- ECONOMY

- 6  Built-in memory selected for data storage.
-  Memory card selected for data storage.

7 Date and time

8 Battery capacity

▶▶ IMPORTANT! ◀◀

- Some information may not display properly if you display an image that was recorded using a different digital camera model.

Changing the Contents of the Monitor Screen

Each press of the [DISP] button changes the contents of the monitor screen as shown below.

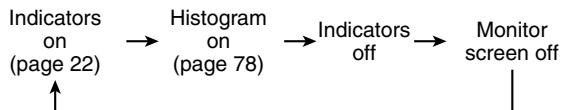

▶▶ IMPORTANT! ◀◀

- You cannot turn off the monitor screen in the following cases:
In the PLAY mode, in the BESTSHOT mode.
- You cannot use the [DISP] button to change the contents of the monitor screen while standing by for or performing audio recording.
- In the Voice Recording mode, you can only turn indicators on and off.

Indicator Lamps

You can find out the operational status of the camera and the USB cradle at a glance by checking the color of the indicator lamps, and whether a lamp is lit or flashing. For details, see “Indicator Lamp Reference” on page 166.

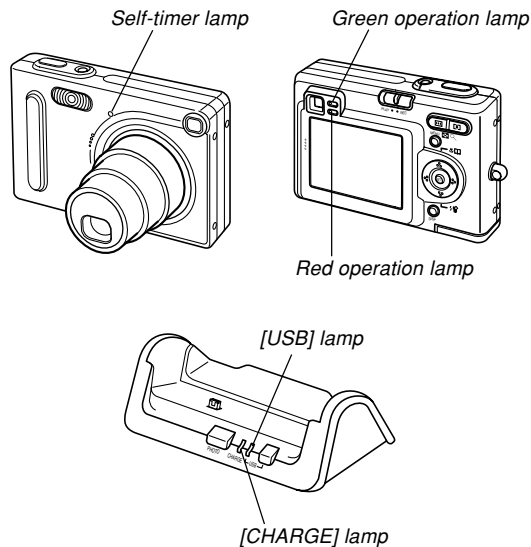

Attaching the Strap

Attach the strap to the strap ring as shown in the illustration.

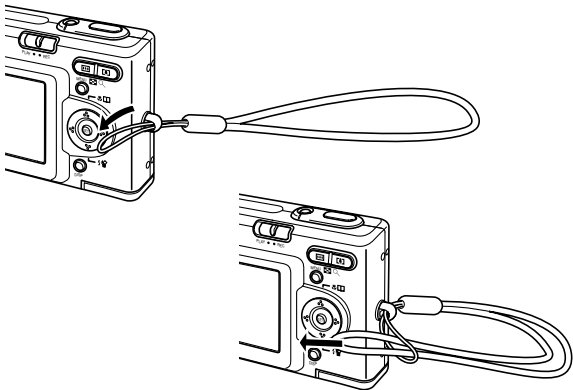

►► IMPORTANT! ◀◀

- Be sure to keep the strap around your wrist when using the camera to protect against accidentally dropping it.
- The supplied strap is intended for use with this camera only. Do not use it for any other purpose.
- Never swing the camera around by the strap.

Power Requirements

Your camera is powered by a rechargeable lithium ion battery (NP-20).

To load the battery

1. While pressing the battery compartment cover on the bottom of the camera, slide the cover in the direction indicated by the arrow, and then swing it open.

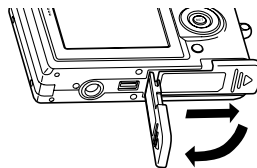

GETTING READY

2. While pulling the stopper in the direction indicated by the arrow in the illustration, align the arrow mark on the battery with the arrow mark on the camera and slide the battery into the camera.

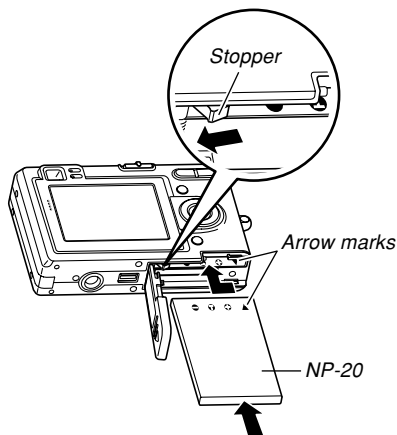

- Push the bottom of the battery, and make sure that the stopper securely locks the battery in place.

3. Swing the battery compartment cover closed, and then slide it in the direction indicated by the arrow.

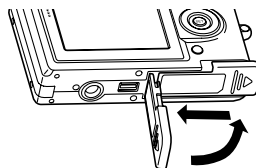

►► IMPORTANT! ◀◀

- Use only the special NP-20 rechargeable lithium ion battery to power this camera. Use of any other type of battery is not supported.

The battery is not charged when you purchase the camera. You need to charge the battery before using the camera for the first time (page 28).

To remove the battery

1. Open the battery compartment cover.
2. Pull the stopper in the direction indicated by the arrow.
 - This will cause the battery to come part way out of the slot.

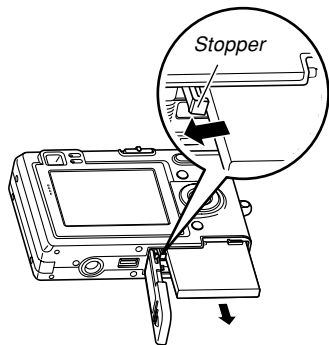

3. Release the stopper and pull the battery from the camera.

- Take care so you do not drop the battery.

To charge the battery

1. Connect the bundled AC adaptor to the [DC IN 5.3V] connector of the USB cradle.
2. Extend the prongs of the AC adaptor, and then plug it into a household power outlet.

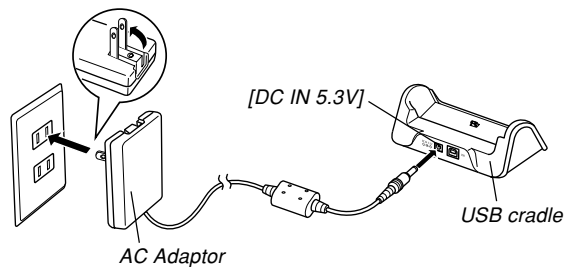

3. Turn off the camera.**4. Set the camera onto the USB cradle.**

- Do not place the camera onto the USB cradle while it is turned on.
- The [CHARGE] lamp on the USB cradle should turn red, indicating that charging has started. When charging is complete, the [CHARGE] lamp will turn green.

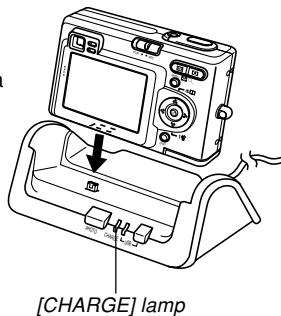
**5. After charging is complete, remove the camera from the USB cradle.****▶▶ IMPORTANT! ◀◀**

- It takes about two hours to achieve a full charge. Actual charging time depends on current battery capacity and charging conditions.
- Use only the USB cradle (CA-21A) that comes with the camera, the optionally available USB cradle (CA-21), or the optionally available charger unit (BC-10L) to charge the special NP-20 rechargeable lithium ion battery. Never use any other charging device.
- Use only the bundled AC adaptor. Never use any other type of AC adaptor. Do not use optionally available AD-C40, AD-C620 and AD-C630 AC adaptors with this camera.
- Make sure that the camera connector of the USB cradle is securely inserted into the camera's connector as far as it will go.
- The [CHARGE] lamp may remain amber colored and the charge operation may not start right away if you try to charge immediately after using the camera (which causes battery to become warm) or when it is too hot or too cold where you are performing the charge operation. If this happens, simply wait until the battery reaches normal temperature. The [CHARGE] lamp will turn red and charging will start when the battery temperature returns to the allowable charging temperature range.

GETTING READY

- If the [CHARGE] lamp starts flashing red, it means that an error occurs while charging. An error can be caused by any of the following: a problem with the USB cradle, a problem with the camera, or a problem with the battery or how it is loaded. Remove the camera from the USB cradle and see if it works normally.
- You can use the USB cradle to charge the camera's battery, to exchange data with a computer over a USB connection, or when using the Photo Stand feature only.

»» NOTE ««

- The AC adaptor is designed for operation on power ranging from 100V AC to 240V AC. Note, however, that the shape of the power cord plug varies according to country or geographic area. It is up to you to find out if the shape of the AC adaptor power cord plug is compatible with local power outlets when traveling abroad.

■ If the camera works normally

1. **Continue using the camera until the current charge is used up, and then charge the battery.**

■ If the camera does not work normally

This can mean there is a problem with how the battery is loaded.

1. **Remove the battery from the camera and check the battery contacts for dirt. If the contacts are dirty, wipe them clean with a dry cloth.**
2. **Check to make sure that the AC adaptor's power cord is connected securely to the power outlet and USB cradle.**
 - If the same symptoms occur again when you place the camera on the USB cradle after taking the above steps, contact a CASIO authorized service center.

■ Battery Life Guidelines

The battery life guideline values given below indicate the amount of time under the conditions defined below the table, until power automatically turns off due to battery failure. They do not guarantee that the battery will provide the amount of service indicated. Low temperatures and continued use reduce battery life.

Operation	Approximate Battery Life
Number of Shots, Continuous Recording* ¹ (Recording Time)	540 shots (90 minutes)
Number of Shots, Normal Recording* ² (Recording Time)	140 shots (70 minutes)
Continuous Playback* ³ (Continuous Snapshot Recording)	150 minutes
Continuous Voice Recording* ⁴	130 minutes

Supported Battery: NP-20 (Rated Capacitance: 680mAh)

*1 Continuous Recording Conditions

- Temperature: 23°C (73°F)
- Monitor screen: On
- Flash: Off
- Image recorded about every 10 seconds

*2 Normal Recording Conditions

- Temperature: 23°C (73°F)
- Monitor Screen: On
- Zoom operation between full wide to full telephoto every 30 seconds, during which two images are recorded, one image with flash; power turned off and back on every time 10 images are recorded.

*3 Continuous Playback Conditions

- Temperature: 23°C (73°F)
- Scroll one image about every 10 seconds



*4 Voice recording times are based on continuous recording.





- The above values are based on a new battery starting from a full charge. Repeated charging shortens battery life.
- Battery life is greatly affected by how much you use flash, zoom and other functions, and how long you leave power turned on.

■ Tip to Make the Battery Last Longer

- If you do not need the flash while recording, select  (flash off) for the flash mode. See page 51 for more information.
- You can also conserve battery power by using the [DISP] button to turn off the monitor screen.

■ Low Battery Indicator

The following shows how the battery capacity indicator on the monitor screen changes as battery power is used. The  indicator means that remaining battery power is low. Note that you will not be able to record images while the battery indicator is . Charge the battery immediately whenever either of these indicators appears.

Battery Level	High  Low
Indicator	 →  →  → 

Power Supply Precautions

Note the following precautions when handling or using the battery and the optional charger unit.

■ Battery Handling Precautions

● SAFETY PRECAUTIONS

Be sure to read the following Safety Precautions before trying to use the battery for the first time. Keep these safety precautions and all operating instructions on hand for future reference.

»» NOTES ««

- The term “battery” in this manual refers to the CASIO NP-20 Rechargeable Lithium Ion Battery.
- Use only the USB cradle (CA-21A) that comes with the camera, the optionally available USB cradle (CA-21), or the optionally available charger unit (BC-10L) to charge the special NP-20 rechargeable lithium ion battery. Never use any other charging device.

GETTING READY

- Failure to observe any of the following precautions while using the battery creates the risk of overheating, fire, and explosion.
 - Never use any other type of charger except the optional charger unit specified for the battery.
 - Never try to use the battery to power any other device other than this camera.
 - Never use or leave the battery near open flame.
 - Never place the battery in a microwave oven, throw it into fire, or otherwise expose it to intense heat.
 - Make sure the battery is oriented correctly when you load it into the camera or attach it to the optional charger unit.
 - Never carry or store the battery together with items that can conduct electricity (necklaces, pencil lead, etc.)
 - Never try to take the battery apart, modify it in any way, or expose it to strong impact.
 - Do not immerse the battery in fresh water or salt water.
 - Do not use or leave the battery under direct sunlight, in an automobile parked in the sun, or in any other area subject to high temperatures.
- Should you ever notice leakage, strange odor, heat generation, discoloration, deformation, or any other abnormal condition while using, charging, or storing a battery, immediately remove it from the camera or optional charger unit and keep it away from open flame.
- If the battery does not achieve full charge after the normal charging time has passed, stop charging. Continued charging creates the risk of overheating, fire, and explosion.
- Battery fluid can damage your eyes. Should battery fluid get into your eyes accidentally, immediately rinse them with clean tap water and then consult a physician.
- Be sure to read page 28 of this User's Guide and the instructions that come with the optional charger unit before using or charging the battery.
- If the battery is to be used by young children, make sure that a responsible adult makes them aware of the precautions and proper handling instructions and make sure that they handle the battery correctly.
- Should fluid from the battery accidentally get onto clothing or your skin, immediately rinse it off with clean tap water. Prolonged contact with battery fluid can cause skin irritation.

● PRECAUTIONS DURING USE

- The battery is designed for use with this CASIO digital camera only.
- Use only the USB cradle that comes with the camera or the specified optional charger unit to charge the battery. Never use any other type of charger unit for charging.
- A new battery is not charged. Be sure to charge the battery before using it for the first time.
- Use of a battery in cold environments shortens the operating time you can expect on a full charge. Charge the battery in a location where the temperature is in the range of 10°C to 35°C (50°F to 95°F). Charging outside this temperature range can cause charging to take longer than normal or even cause charging to fail.
- Very limited operation following a full charge indicates that the battery has reached the end of its service life. Replace the battery with a new one.
- Never wipe the battery with thinner, benzene, alcohol, or other volatile agents or chemically treated rags. Doing so can cause deformation of the battery and lead to malfunction.

● BATTERY STORAGE PRECAUTIONS

- Make sure you remove the battery when you do not plan to use the camera for a long time. A battery left in the camera discharges very small amounts of power even when power is turned off, which can lead to a dead battery or the need for longer charging before the next use.
- Store the battery in a cool, dry place (20°C (68 °F) or lower).

● USING THE BATTERY

- See page 28 of this manual or the instructions that come with the optional charger unit for information about charging procedures and charging times.
- When transporting a battery, keep it either loaded in the camera or stored in its case.

■ USB Cradle and AC Adaptor Precautions



Caution!

- Never use an electrical outlet whose voltage is outside the rating marked on the AC adaptor. Doing so can create the danger of fire or electric shock. Use only the bundled AC adaptor specified for this camera.
- Do not allow the AC adaptor cord to become cut or damaged, do not place heavy objects on it, and keep it away from heat. A damaged power cord creates the risk of fire and electric shock.
- Never try to modify the AC adaptor cord, or subject it to severe bending, twisting, or pulling. Doing so creates the risk of fire and electric shock.
- Never touch the AC adaptor while your hands are wet. Doing so creates the risk of electric shock.
- Do not overload extension cords or wall outlets. Doing so creates the danger of fire and electric shock.
- Should the cord of the AC adaptor become damaged (exposed internal wiring), request a replacement from a CASIO authorized service center. A damaged AC adaptor cord creates the danger of fire or electric shock.



Caution!

- Use the AC adaptor where it will not be splashed with water. Water creates the risk of fire and electric shock.
- Do not place a vase or any other container filled with liquid on top of the AC adaptor. Water creates the risk of fire and electric shock.
- Make sure you always remove the camera from the USB cradle before connecting or disconnecting the AC adaptor.
- Charging, USB data communication, and using the Photo Stand feature can cause the AC adaptor to become warm. This is normal and does not indicate malfunction.
- Unplug the AC power cord from the power outlet whenever you are not using it.
- Never place a blanket or any other cover on the AC adaptor. Doing so creates the risk of fire.

Turning the Camera On and Off

Press the power button to turn the camera on and off. Pressing the power button to turn on the camera causes the green operation lamp to light temporarily. Press the power button again to turn off the camera.

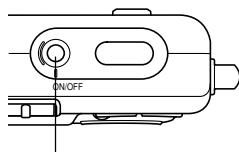

Power button

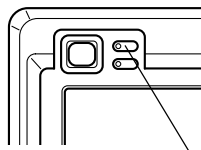

Green operation lamp

»» IMPORTANT! ««

- If camera power is turned off by the Auto Power Off feature, press the power button to turn it back on again.
- Turning on camera power while the REC mode is selected by the mode selector causes the lens to extend from the camera. Make sure there is nothing in front of the camera that can be hit by the lens when you turn on the camera.

Configuring Power Saving Settings

You can configure the settings described below to conserve battery power.

- Sleep** : Automatically turns off the monitor screen if no operation is performed for a specified amount of time in the REC mode. Performing any button operation causes the monitor screen to turn back on.
- Auto Power Off** : Turns off power if you do not perform any operation for a specified amount of time.

- 1. Turn on the camera, and then align the mode selector with “REC” or “PLAY”.**
- 2. Press [MENU].**
- 3. Use [◀] and [▶] to select the “Set Up” tab.**
- 4. Use [▲] and [▼] to select the feature whose setting you want to configure, and then press [SET].**

GETTING READY

- See page 37 for information about how to use menus.

To configure this feature:	Select this setting:
Sleep	Sleep
Auto Power Off	Auto Power Off

5. Use [▲] and [▼] to change the currently selected setting, and then press [SET].

- Available Sleep settings are: “30 sec”, “1 min”, “2 min”, and “Off”.
- Available Auto Power Off settings are: “2 min” and “5 min”.
- Note that the Sleep feature does not operate in the PLAY mode.
- Pressing any button while the camera is in the Sleep state immediately turns the monitor screen back on.
- The Auto Power Off and Sleep features are disabled in the following cases.
 - When the camera is connected to a computer or some other device through the USB cradle
 - While a slideshow is in progress
 - While playing back a voice recording file

Using the On-screen Menus

Pressing [MENU] displays menus on the monitor screen that you can use to perform various operations. The menu that appears depends on whether you are in the REC mode or the PLAY mode. The following shows an example menu procedure in the REC mode.

1. Turn on the camera, and then align the mode selector with “REC” to enter the REC mode.

- If you want to enter the PLAY mode instead, you would align the mode selector with “PLAY”.

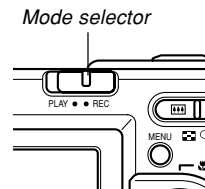

2. Press [MENU].

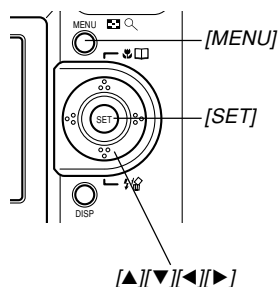
**Settings**

Selection cursor (indicates the currently selected item)

● Menu Screen Operations

When you want to do this:	Do this:
Move between tabs	Press [◀] and [▶].
Move from the tab to the settings	Press [▼].
Move from the settings to the tab	Press [▲].
Move between the settings	Press [▲] and [▼].
Display the options available for a setting	Press [▶] or press [SET].
Select an option	Press [▲] and [▼].
Register an option selection and exit the menu screen	Press [SET].
Register an option selection and return to the menu screen	Press [◀].
Exit the menu screen	Press the [MENU] button.

3. Press [◀] or [▶] to select the tab you want, and then press [SET] to move the selection cursor from the tab to the settings.

4. Use [▲] and [▼] to select the feature whose setting you want to configure, and then press [▶].

- Instead of pressing [▶], you could also press [SET].



Example: To select the "REC Mode" item.

5. Use [▲] and [▼] to change the currently selected setting.

6. Perform one of the following operations to apply the setting you configured.

To do this:	Perform this key operation:
Apply the setting and exit the menu screen.	Press [SET].
Apply the setting and return to feature selection in step 4.	Press [◀].
Apply the setting and return to tab selection in step 3.	<ol style="list-style-type: none"> 1. Press [◀]. 2. Use [▲] to move back up to tab selection.

- See "Menu Reference" on page 164 for more information about menus.

Configuring Display Language and Clock Settings

Be sure to configure the following settings before using the camera to record images.

- Display language
- Home city
- Date Style
- Date and time

Note that the current date and time settings are used by the camera to generate the date and time that are stored along with image data, etc.

►► IMPORTANT! ◀◀

- The camera's clock settings are cleared whenever power is totally cut off. This can happen if the battery goes dead while the camera is not being supplied power by the USB cradle. The clock setting screen will appear automatically the next time you turn on power after the settings are cleared. Set the date and time before using the camera.
- The current date and time settings will be cleared if the battery remains dead without being charged for about two days.
- Recording images without configuring the clock settings causes incorrect time information to be registered. Be sure to configure the clock settings before using the camera.

To configure display language and clock settings

1. Press the power button to turn on the camera.
2. Use [▲], [▼], [◀], and [▶] to select the language you want, and then press [SET].



日本語	: Japanese
English	: English
Français	: French
Deutsch	: German
Español	: Spanish
Italiano	: Italian
Português	: Portuguese
中國語	: Chinese (Complex)
中国語	: Chinese (Simplified)
한국어	: Korean

3. Use [▲], [▼], [◀], and [▶] to select the geographical area where you live, and then press [SET].



4. Use [▲] and [▼] to select the name of the city where you live, and then press [SET].



5. Use [▲] and [▼] to select the summer time (DST) setting you want, and then press [SET].

When you want to do this:	Select this setting:
Keep time using summer time (Daylight Saving Time)	On
Keep time using standard time	Off

GETTING READY

6. Use [▲] and [▼] to change the date format setting, and then press [SET].

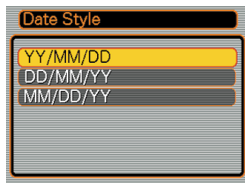

Example: December 24, 2003

To display the date like this:	Select this format:
03/12/24	YY/MM/DD
24/12/03	DD/MM/YY
12/24/03	MM/DD/YY

7. Set the current date and the time.

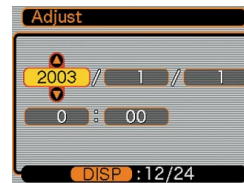

To do this:	Do this:
Change the setting at the current cursor location	Press [▲] and [▼].
Move the cursor between settings	Press [◀] and [▶].
Toggle between 12-hour and 24-hour timekeeping	Press [DISP].

8. Press [SET] to register the settings and exit the setting screen.

BASIC IMAGE RECORDING

This section describes the basic procedure for recording an image.

Recording an Image

Aiming the Camera

Use both hands to hold the camera still when shooting an image. Holding the camera with one hand increases the chance of movement, which can blur your images.

- Horizontal



Hold the camera still in both hands, with your arms firmly against your sides.

- Vertical



When holding the camera vertically, make sure that the flash is above the lens. Hold the camera still with both hands.

IMPORTANT!

- Make sure your fingers or the strap does not block the flash, microphone or lens.

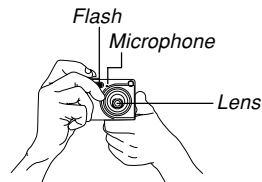

NOTE

- Your image will be blurred if you move the camera when pressing the shutter release button. Press the shutter release button carefully, taking care that there is no camera movement. This is especially important when available lighting is low, which slows down the shutter speed.

Recording an Image

Your camera automatically adjusts shutter speed in accordance with the brightness of the subject. Images you record are stored in the camera's built-in memory, or to a memory card if you have one loaded in the camera.

- When an optionally available SD memory card or MultiMediaCard (MMC) is loaded in the camera, images are stored on the card (page 130).

1. Press the power button to turn on the camera.

- This causes an image or a message to appear on the monitor screen.

Power button

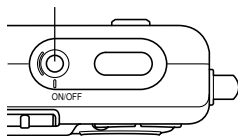

2. Align the mode selector with "REC".

- This enters the REC mode for image recording.

Mode selector

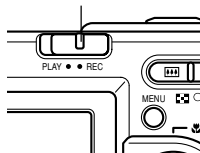

3. Compose the image on the monitor screen so the main subject is within the focus frame.

- The focusing range of the camera in the Auto Focus mode is approximately 40cm (1.3 feet) to infinity (∞) (page 58).
- You can compose images using either the monitor screen or the optical viewfinder (page 48).
- When using the optical viewfinder to compose images, you can use the [DISP] button to turn off the monitor screen and conserve battery power.

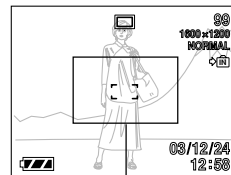

Focus frame

4. Press the shutter release button half way to focus the image.

- When you press the shutter release button half way, the camera's Auto Focus feature automatically focuses the image, and displays the shutter speed and aperture values.
- You can tell whether the image is focused by observing the focus frame and the green operation lamp.

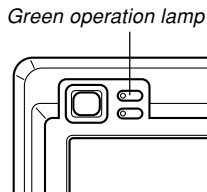
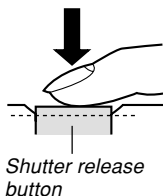

● Operation Lamp and Focus Frame Operation

When you see this:	It means this:
Green focus frame Green operation lamp	The image is in focus.
Red focus frame Flashing green operation lamp	The image is not in focus.

- Make sure you are not blocking the lens or the flash with your fingers while recording an image.

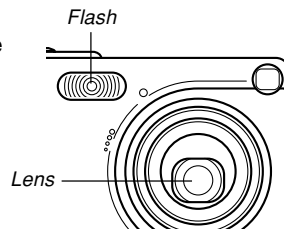

5. After making sure that the image is focused properly, press the shutter release button the rest of the way down to record.

- The number of images that can be stored in memory depends on the resolution setting you are using (pages 55,174).
- Press the shutter release button gently to avoid camera movement.

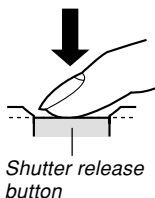

Recording Precautions

- Never open the battery compartment cover or place the camera onto the USB cradle while the green operation lamp is flashing. Doing so not only causes the current image to be lost, it can also corrupt images already stored in file memory and even lead to malfunction of the camera.
- Never remove the memory card while an image is being recorded to the memory card.
- Fluorescent lighting actually flickers at a frequency that cannot be detected by the human eye. When using the camera indoors under such lighting, you may experience some brightness or color problems with recorded images.
- When "Auto" is selected for the ISO sensitivity setting (page 80), the camera automatically adjusts its sensitivity in accordance with the brightness of the subject. This can cause some static noise to appear in images of relatively dark subjects.
- When recording a dimly lit subject while "Auto" is selected for the ISO sensitivity setting (page 80), the camera increases sensitivity and uses a slower shutter speed. Because of this, you need to guard against camera movement if you have flash turned off (page 51).
- If unwanted light is shining on the lens, shade the lens with your hand when recording the image.

About Auto Focus

- Auto Focus tends not to work well if the camera is moved during recording, or when recording the types of subjects listed below.
 - Solid color walls or objects with little contrast
 - Strongly backlit objects
 - Polished metal or other brightly reflective objects
 - Venetian blinds or other horizontally repeating patterns
 - Multiple images that are varying distances from the camera
 - Subjects in poorly lit areas
 - Moving subjects
- Note that a green operation lamp and focus frame do not necessarily guarantee that an image is in focus.
- If Auto Focus does not produce the results you want for some reason, try using focus lock (page 63) or manual focus (page 62).

About the REC Mode Monitor Screen

- The image shown on the monitor screen in the REC mode is a simplified image for composing purposes. The actual image is recorded in accordance with the image quality setting currently selected on your camera. The image saved in file memory has much better resolution and detail than the REC mode monitor screen image.
- Certain levels of subject brightness can cause the response of the REC mode monitor screen to slow down, which causes some static noise in the monitor screen image.

Using the Optical Viewfinder

You can conserve battery power by turning off the camera's monitor screen (page 25) and using the optical viewfinder to compose images.

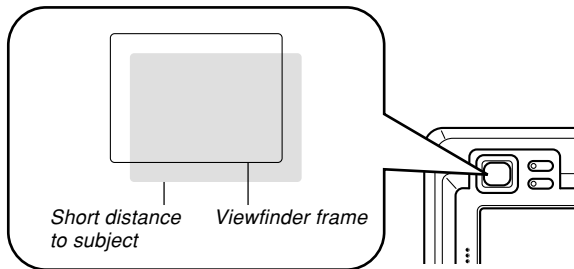

►► IMPORTANT! ◀◀

- The frame that is visible inside of the viewfinder indicates the image recorded at a distance of about one meter (3.3'). When the subject is closer than one meter, the recorded image will be different from what you see inside the viewfinder frame.
- Since the monitor screen shows exactly what will be recorded, always use it for composing your images in the Macro and Manual Focus modes.

Using Zoom

Your camera is equipped with two types of zoom: optical zoom and digital zoom.

Optical Zoom

The range of the optical zoom factor is shown below.

Optical Zoom Factor Range: 1X to 3X

1. In the REC mode, press the zoom button to change the zoom factor.

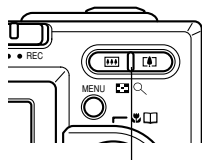

Zoom button

To do this:	Press this side of the zoom button:
Zoom out	(Wide Angle)
Zoom in	(Telephoto)

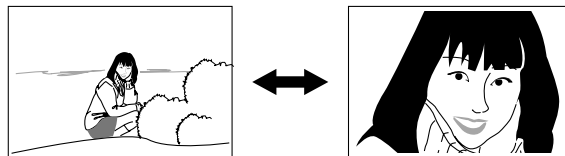

Zoom out

Zoom in

2. Compose the image and then press the shutter release button.

NOTES

- The optical zoom factor also affects the lens aperture.
- Use of a tripod is recommended to protect against hand movement when using the telephoto setting (zoom in).

Digital Zoom

Digital zoom is activated after you reach the maximum optical zoom factor (3X). It enlarges the part of the image at the center of the image screen. The range of the digital zoom factor is shown below.

Digital Zoom Factor Range: 3X to 12X
(in combination with optical zoom)

1. In the REC mode, press [MENU].
2. Use [◀] and [▶] to select the “REC” tab.
3. Use [▲] and [▼] to select “Digital Zoom”, and then press [▶].
4. Select “On”, and then press [SET].
 - Selecting “Off” disables digital zoom.

5. Hold down the [⏏] (Telephoto) zoom button to increase the optical zoom factor.

- When the digital zoom factor reaches its maximum value (3X), it stops momentarily. Keep the [⏏] (Telephoto) zoom button depressed and zoom will switch over to digital zoom automatically.
- Switching to digital zoom causes the zoom indicator to appear on the monitor screen. The zoom indicator shows the current approximate zoom factor.

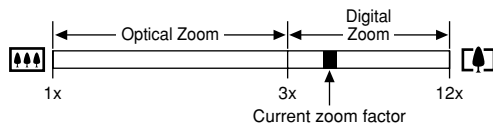
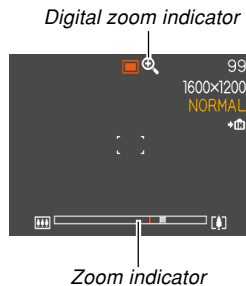

6. Compose the image and then press the shutter release button.

▶▶ IMPORTANT! ◀◀

- Digital zoom is disabled whenever the monitor screen is turned off (page 25).
- Using digital zoom can cause degradation of the recorded image.

Using the Flash

Perform the following steps to select the flash mode you want to use.

1. In the REC mode, press [MENU].

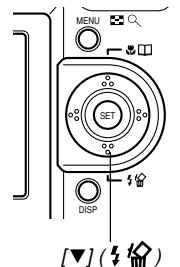

2. Press [▼] (⚡🏠) to select the flash mode.

- Each press of [▼] (⚡🏠) cycles through the flash mode settings shown below on the monitor screen.

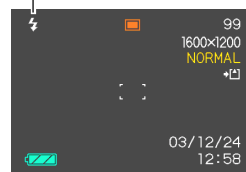

Flash mode indicator



To do this:	Select this setting:
Have the flash fire automatically when required (Auto Flash)	None
Turn off the flash (Flash Off)	
Always fire the flash (Flash On)	
Fire a pre-flash followed by image recording with flash, reducing the chance of red-eye in the image (Red-eye reduction) In this case, the flash fires automatically when required	

3. Record the image.

▶▶ IMPORTANT! ◀◀

- The flash unit of this camera fires a number of times when you record an image. The initial flashes are pre-flashes, which the camera uses to obtain information that it uses for exposure settings. The final flash is for recording. Make sure that you keep the camera still until the shutter releases.
- Image recording may not be performed if you press the shutter release button while the red operation lamp is flashing.

■ About Red-eye Reduction

Using the flash to record at night or in a dimly lit room can cause red spots inside the eyes of people who are in the image. This is caused when the light from the flash reflects off of the retina of the eye. When red-eye reduction is selected as the flash mode, the camera performs two pre-flash operations, one designed to cause the irises in the eyes of any people in the image to close, and one for the Auto Focus operation. This is followed by another flash operation for actual recording of the image.

▶▶ IMPORTANT! ◀◀

Note the following important points when using red-eye reduction.

- Red-eye reduction does not work unless the people in the image are looking directly at the camera during the pre-flash. Before pressing the shutter release button, call out to the subjects so they all look at the camera while the pre-flash operation is performed.
- Red-eye reduction may not work very well if the subjects are located far away from the camera.

Flash Unit Status

You can find out the current flash unit status by pressing the shutter release button half way and checking the monitor screen and red operation lamp.

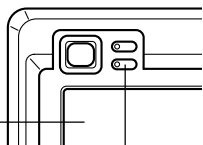

The  indicator is also shown on the monitor screen when the flash unit is ready to fire.

Red operation lamp*



* Red operation lamp

When the red operation lamp is this:	It means this:
Flashing	Flash unit is charging
Lit	Flash unit is ready to fire

Flash Precautions

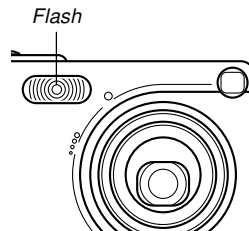
Take care that your fingers do not block the flash when you hold the camera. Covering the flash with your finger can greatly reduce its effectiveness.



- You may not be able to achieve the desired results using a flash if the subject is too close or too far away.
- The flash takes anywhere from a few seconds to as long as 10 seconds to attain full charge after being fired. The actual time required depends on the battery level, temperature, and other conditions.
- The flash unit may not be able to charge when battery power is low. Low battery power is indicated by  (Flash Off) on the monitor screen, and when the flash fails to fire properly resulting in poor image exposure. When these symptoms occur, charge the camera's battery as soon as possible.
- When the red-eye reduction mode  is selected, flash intensity is adjusted automatically in accordance with the exposure. The flash may not fire at all when the subject is brightly lit.
- Using flash in combination with another light source (daylight, fluorescent light, etc.) can result in abnormal image colors.

Using the Self-timer

The self-timer lets you select either a 2-second or 10-second delay of the shutter release after you press the shutter release button. A Triple Self-timer feature lets you perform three consecutive self-timer operations to record three images.

1. In the REC mode, press [MENU].
2. Use [◀] and [▶] to select the “REC” tab.
3. Use [▲] and [▼] to select “Self-timer”, and then press [▶].
4. Use [▲] and [▼] to select the self-timer time you want to use, and then press [SET].
 - Selecting “Off” in step 4 disables the self-timer.

To do this:	Select this setting:
Specify a 10-second self-timer	10 sec
Specify a 2-second self-timer	2 sec
Specify Triple Self-timer	X3
Disable the self-timer	Off

- With the Triple Self-timer, the camera records a series of three images in the sequence described below.
 1. The camera performs a 10-second countdown and then records the first image.
 2. The camera prepares to record the next image. The amount of time required for preparation depends on the camera’s current “Size” and “Quality” settings, the type of memory (built-in or card) you are using for image storage, and whether or not the flash is charging.
 3. After preparation is complete, the indicator “1 sec” appears on the monitor screen, and another image is recorded one second later.
 4. Steps 2 and 3 are repeated once more to record the third image.

5. Record the image.

- When you press the shutter release button, the self-timer lamp flashes and the shutter releases after the self-timer reaches the end of its countdown.
- You can interrupt an ongoing self-timer countdown by pressing the shutter release button while the self-timer lamp is flashing.

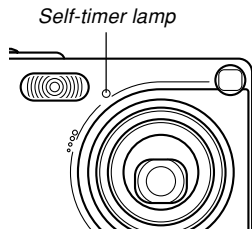

NOTE

- The “2 sec” self-timer setting is best when shooting with a slow shutter speed, because it helps to avoid blurring of images due to hand movement.

Specifying Image Size and Quality

You can specify the image size and image quality to suit the type of image you are recording.

To specify the image size

1. In the REC mode, press [MENU].
2. Use [◀] and [▶] to select the “REC” tab.
3. Use [▲] and [▼] to select “Size”, and then press [▶].
4. Use [▲] and [▼] to select the setting you want, and then press [SET].

2304 x 1728	:	2304 x 1728	pixels
2304 x 1536 (3:2)	:	2304 x 1536 (3:2)	pixels
1600 x 1200	:	1600 x 1200	pixels
1280 x 960	:	1280 x 960	pixels
640 x 480	:	640 x 480	pixels

»» NOTES ««

- If you plan to make large prints of your images or otherwise use them in applications where high-resolution is your top priority, select the “2304 x 1728” image size.
- If you plan to send images as e-mail attachments or otherwise use them in applications where data economy is your top priority, select the “640 x 480” image size.
- Selecting the “2304 x 1536 (3:2)” image size records images with a 3:2 (vertical : horizontal) aspect ratio, which is optimal for printing on paper with an aspect ratio of 3:2.

To specify image quality

1. In the REC mode, press [MENU].
2. Use [◀] and [▶] to select the “REC” tab.
3. Use [▲] and [▼] to select “Quality”, and then press [▶].
4. Use [▲] and [▼] to select the setting you want, and then press [SET].

To get this:	Select this setting:
Very high quality, but large file size	Fine
Normal quality	Normal
Small file size, but low quality	Economy

»» NOTE ««

- Use the “Fine” setting when image quality is your top priority and file size is secondary. Conversely, use the “Economy” setting when file size is your top priority and image quality is secondary.

»» IMPORTANT! ««

- Actual file size depends on the type of image you record. This means that the remaining image capacity noted on the monitor screen may not be exactly accurate (pages 22 and 174).