

CASIO®

Digital Camera

EX-Z33

User's Guide

E

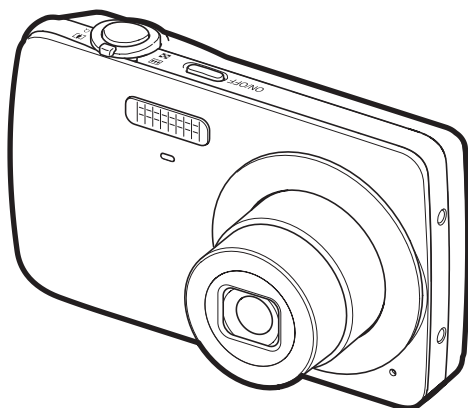

Thank you for purchasing this CASIO product.

- Before using it, be sure to read the precautions contained in this User's Guide.
- Keep the User's Guide in a safe place for future reference.
- For the most up-to-date information about this product, visit the official EXILIM Website at <http://www.exilim.com/>

EXILIM

Unpacking

As you unpack your camera, check to make sure that all items shown below are included. If anything is missing, contact your original retailer.



Digital camera



Rechargeable lithium ion
battery (NP-82*)

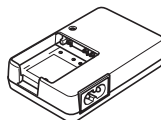

Charger unit (BC-80L)

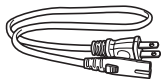

Power cord



Strap

To attach the strap to the camera

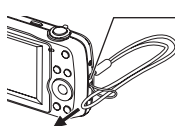

Attach strap here.



USB cable



CD-ROM

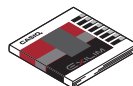

Basic Reference

* The NP-82 battery is specially designed to be included with this EXILIM model. When purchasing a replacement or spare, be sure to purchase an NP-80 battery.

Read this first!

- The contents of this manual and the bundled Basic Reference are subject to change without notice.
- The contents of this manual have been checked at each step of the production process. Feel free to contact us if you notice anything that is questionable, erroneous, etc.
- Any copying of the contents of this User's Guide, either in part or its entirety, is forbidden. Except for your own personal use, any other use of the contents of this manual without the permission of CASIO COMPUTER CO., LTD. is forbidden under copyright laws.
- CASIO COMPUTER CO., LTD. shall not be held liable for any damages or lost profits suffered by you or any third party due to the use or malfunction of this product.
- CASIO COMPUTER CO., LTD. shall not be held liable for any damages, lost profits, or claims by third parties arising out of the use of Photo Transport or YouTube Uploader for CASIO.
- CASIO COMPUTER CO., LTD. shall not be held liable for any damages or lost profits caused by loss of memory contents due to malfunction, repair, or any other reason.
- Note that the example screens and product illustrations shown in this User's Guide may differ somewhat from the screens and configuration of the actual camera.

LCD Panel

The liquid crystal panel of the monitor screen uses high-precision technology that provides a pixel yield in excess of 99.99%. This means that some very small number of pixels may not light or may remain lit at all times. This is due to the characteristics of the liquid crystal panel, and does not indicate malfunction.

Take a few test shots

Before shooting your final image, shoot a test shot to ensure that the camera is recording correctly.

Contents

Unpacking	2
Read this first!	3
General Guide	8
Monitor Screen Contents	10

■ Quick Start Basics 13

What is a digital camera?	13
What you can do with your CASIO camera	14
First, charge the battery prior to use.	15
■ To charge the battery	15
■ To load the battery	16
Configuring Basic Settings the First Time You Turn On the Camera.	18
Preparing a Memory Card	19
■ Supported Memory Cards	19
■ To load a memory card	19
■ To format (initialize) a new memory card	20
Turning the Camera On and Off	21
■ To turn power on	21
■ To turn off the camera	21
To shoot a snapshot.	22
Holding the Camera Correctly	25
Viewing Snapshots	26
Deleting Images.	27
■ To delete a single file	27
■ To delete all files	27
Snapshot Shooting Precautions	28
■ Auto Focus Restrictions	28

■ Snapshot Tutorial 29

Using the Control Panel.	29
Changing the Image Size (Size)	30
Using Flash (Flash)	33
Using Face Detection (Face Detection)	35
Reducing the Effects of Camera and Subject Movement (Anti Shake)	36
Specifying ISO Sensitivity (ISO)	37
Adjusting White Balance (White Balance)	37
Correcting Image Brightness (EV Shift)	39
Using the easy Mode.	40
Changing the Control Panel Date/Time Style	42
Shooting with Zoom.	42
■ Optical Zoom and Digital Zoom Switch Point	43

■ Recording Movie Images and Audio 45

To record a movie	45
-----------------------------	----

Shooting a Snapshot while Shooting a Movie	47
Recording Audio Only	(Voice Recording) .. 47
■ To play back an audio recording	48

■ Using BEST SHOT 49

What is BEST SHOT?	49
■ Some Sample Scenes	49
To shoot an image with BEST SHOT	49

■ Advanced Settings 52

Using On-screen Menus	52
REC Mode Settings	(REC) .. 54
■ Selecting a Focus Mode	(Focus) .. 54
■ Changing the Focus Frame Shape	(Focus Frame) .. 57
■ Using Continuous Shutter	(CS) .. 58
■ Using the Self-timer	(Self-timer) .. 59
■ Shooting with Face Detection	(Face Detection) .. 60
■ Reducing the Effects of Camera and Subject Movement	(Anti Shake) .. 60
■ Specifying the Auto Focus Area	(AF Area) .. 60
■ Using the easy Mode	(easy Mode) .. 61
■ Assigning Functions to the [◀] and [▶] Keys	(L/R Key) .. 61
■ Displaying the On-screen Grid	(Grid) .. 61
■ Turning Digital Zoom On or Off	(Digital Zoom) .. 62
■ Turning on Image Review	(Review) .. 62
■ Using Icon Help	(Icon Help) .. 62
■ Configuring Power On Default Settings	(Memory) .. 63
Image Quality Settings	(Quality) .. 64
■ Specifying Snapshot Size	(Size) .. 64
■ Specifying Snapshot Image Quality	(Quality (Snapshot)) .. 64
■ Specifying Movie Image Quality	(Quality (Movie)) .. 65
■ Correcting Image Brightness	(EV Shift) .. 65
■ Controlling White Balance	(White Balance) .. 65
■ Specifying ISO Sensitivity	(ISO) .. 66
■ Specifying the Metering Mode	(Metering) .. 66
■ Using Built-in Color Filters	(Color Filter) .. 66
■ Controlling Image Sharpness	(Sharpness) .. 67
■ Controlling Color Saturation	(Saturation) .. 67
■ Adjusting Image Contrast	(Contrast) .. 67
■ Specifying Flash Intensity	(Flash Intensity) .. 67

■ Viewing Snapshots and Movies 68

Viewing Snapshots	68
Viewing a Movie	68
Zooming an On-screen Image	69
Displaying the Image Menu	69
Viewing Snapshots and Movies on a TV Screen	70

■ Other Playback Functions (PLAY) 72

Playing a Slideshow on the Camera (Slideshow)	72
Selecting Images for Printing (DPOF Printing)	73
Protecting a File Against Deletion (Protect)	73
Rotating an Image (Rotation)	74
Resizing a Snapshot (Resize)	74
Cropping a Snapshot (Trimming)	75
Adding Audio to a Snapshot (Dubbing)	75
■ To play snapshot audio	76
Copying Files (Copy)	77

■ Printing 78

Printing Snapshots	78
Connecting Directly to a PictBridge Compatible Printer	79
Using DPOF to Specify Images to be Printed and the Number of Copies	81

■ Using the Camera with a Computer 84

Things you can do using a computer...	84
Using the Camera with a Windows Computer	85
■ Viewing and Storing Images on a Computer	86
■ Playing Movies	89
■ Uploading Movie Files to YouTube	90
■ Transferring Images from Your Computer to Camera Memory	92
■ Viewing User Documentation (PDF Files)	94
■ User Registration	94
Using the Camera with a Macintosh	95
■ Connecting the Camera to Your Computer and Saving Files	95
■ Transferring Images Automatically and Managing Them on Your Macintosh	98
■ Playing a Movie	98
■ Viewing User Documentation (PDF Files)	99
■ User Registration	99
Using an Eye-Fi Wireless SD Memory Card to Transfer Images . (Eye-Fi)	99
Files and Folders	101
Memory Card Data	102

■ Other Settings (Set Up) 104

Selecting a REC Mode Screen Layout ( Panel)	104
Turning off Eye-Fi Card Communication (Eye-Fi)	104
Configuring Camera Sound Settings (Sounds)	105
Configuring a Startup Image (Startup)	105
Specifying the File Name Serial Number Generation Rule (File No.)	106
Configuring World Time Settings (World Time)	106
Time Stamping Snapshots (Timestamp)	107
Setting the Camera's Clock (Adjust)	108

Specifying the Date Style (Date Style)	108
Specifying the Display Language (Language)	109
Configuring Sleep State Settings (Sleep)	109
Configuring Auto Power Settings (Auto Power Off)	110
Configuring [📷] and [▶] Settings (REC/PLAY)	110
Configuring USB Protocol Settings (USB)	111
Selecting the Screen Aspect Ratio and Video Output System (Video Out)	111
Formatting Built-in Memory or a Memory Card (Format)	112
Resetting the Camera to Factory Defaults (Reset)	112

■ ■ **Configuring Monitor Screen Settings** **113**

Using the On-screen Histogram to Check Exposure (+Histogram)	113
■ How to Use the Histogram	114

■ ■ **Appendix** **115**

Precautions during Use	115
Power Supply	122
■ Charging	122
■ To replace the battery	122
■ Battery Precautions	123
■ Using the Camera in another Country	123
Using a Memory Card	124
■ To replace the memory card	124
Computer System Requirements for Bundled Software	126
Reset Initial Default Settings	127
When things don't go right...	129
■ Troubleshooting	129
■ Display Messages	134
Number of Snapshots/Movie Recording Time/Voice Recording Time	136
Specifications	138

General Guide

The numbers in parentheses indicate the pages where each item is explained.

■ Camera

Front

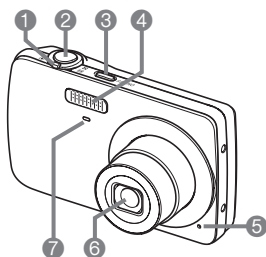

- 1 Zoom controller (pages 22, 42, 69)
- 2 Shutter button (page 22)
- 3 [ON/OFF] (Power) (page 21)
- 4 Flash (page 33)
- 5 Microphone (pages 46, 76)
- 6 Lens
- 7 Front lamp (pages 25, 59)

Back

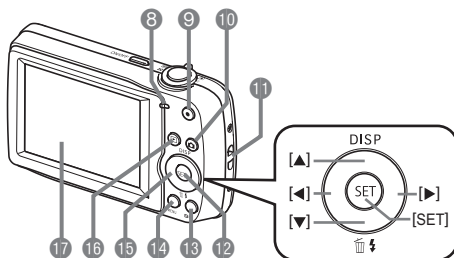

- 8 Back lamp (pages 21, 23, 33)
- 9 [●] (movie) button (page 45)
- 10 [📷] (REC) button (pages 21, 22)
- 11 Strap hole (page 2)
- 12 [SET] button (page 29)
- 13 [BS] button (page 49)
- 14 [MENU] button (page 52)
- 15 Control button ([▲] [▼] [◀] [▶]) (pages 27, 29, 33, 52, 113)
- 16 [▶] (PLAY) button (pages 21, 26)
- 17 Monitor screen (pages 10, 113)

Bottom

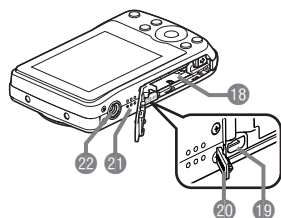

- 18 Battery/memory card slots (pages 16, 19, 122, 124)
- 19 USB/AV port (pages 70, 79, 87, 96)
- 20 Connector cover
- 21 Speaker
- 22 Tripod hole
Use this hole when attaching to a tripod.

■ Charger Unit

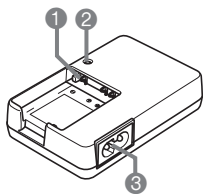

- ① ⊕ ⊖ Contacts
- ② [CHARGE] Lamp
- ③ AC jack

Monitor Screen Contents

The monitor screen uses various indicators, icons, and values to keep you informed of the camera's status.

- The sample screens in this section are intended to show you the locations of all the indicators and figures that can appear on the monitor screen in various modes. They do not represent screens that actually appear on the camera.

■ Snapshot Recording

Panel : Off

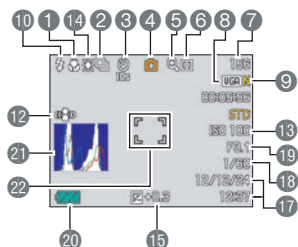

Panel : On

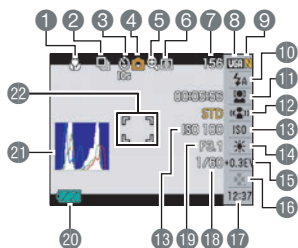

- 1 Focus mode (page 54)
- 2 Continuous shutter (page 58)
- 3 Self-timer (page 59)
- 4 Recording mode (page 22)
- 5 Image deterioration indicator (page 43)
- 6 Metering mode (page 66)
- 7 Remaining snapshot memory capacity (page 136)
- 8 Snapshot image size (page 30)
- 9 Snapshot image quality (page 64)
- 10 Flash (page 33)
- 11 Face detection (page 35)
- 12 Anti Shake (page 36)
- 13 ISO sensitivity (page 37)
- 14 White balance setting (page 37)
- 15 Exposure compensation (page 39)
- 16 easy Mode (page 40)
- 17 Date/time (page 42)
- 18 Shutter speed
- 19 Aperture value
- 20 Battery level indicator (page 17)
- 21 Histogram (page 113)
- 22 Focus frame (pages 23, 60)

NOTE

- If the current aperture, shutter speed, ISO sensitivity, or Auto Exposure is not correct, the setting will turn orange when you half-press the shutter button.

easy Mode

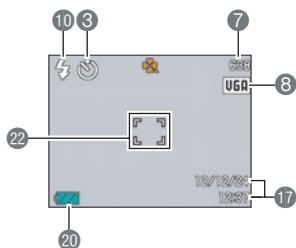

Movie Recording

Panel : Off

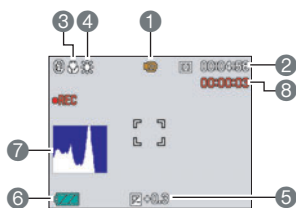

- 1 Recording mode (page 45)
- 2 Remaining movie memory capacity (page 45)
- 3 Focus mode (page 54)
- 4 White balance setting (page 37)
- 5 Exposure compensation (page 39)
- 6 Battery level indicator (page 17)
- 7 Histogram (page 113)
- 8 Movie recording time (page 45)

Panel : On

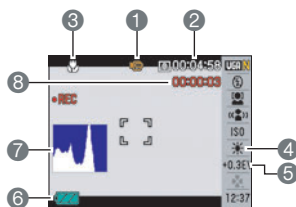

■ Snapshot Viewing

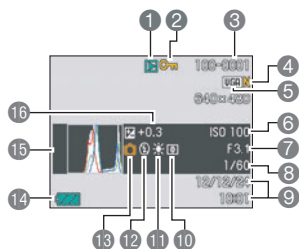

- 1 File type
- 2 Protect indicator (page 73)
- 3 Folder name/file name (page 101)
- 4 Snapshot image quality (page 64)
- 5 Snapshot image size (page 30)
- 6 ISO sensitivity (page 37)
- 7 Aperture value
- 8 Shutter speed
- 9 Date/time (page 42)
- 10 Metering mode (page 66)
- 11 White balance setting (page 37)
- 12 Flash (page 33)
- 13 Recording mode
- 14 Battery level indicator (page 17)
- 15 Histogram (page 113)
- 16 Exposure compensation (page 39)

■ Movie Playback



- 1 File type
- 2 Protect indicator (page 73)
- 3 Folder name/file name (page 101)
- 4 Movie recording time (page 68)
- 5 Movie image quality (page 65)
- 6 Date/time (page 42)
- 7 Battery level indicator (page 17)

Quick Start Basics

What is a digital camera?

A digital camera stores images on a memory card, so you can record and delete images a countless number of times.

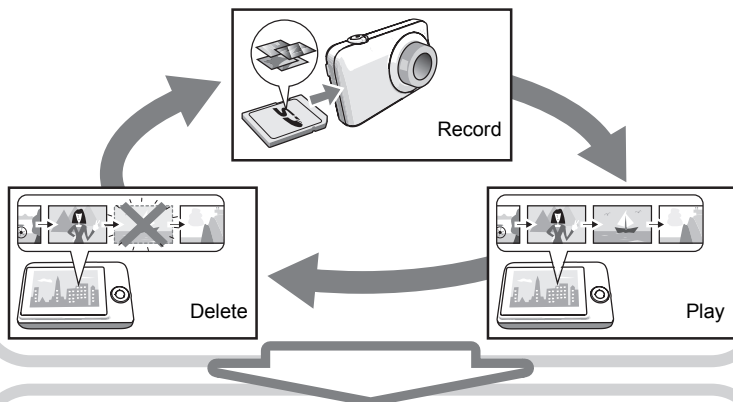

You can use the images you record in a variety of different ways.



Store images on your computer.



Print images.



Attach images to e-mail.

What you can do with your CASIO camera

Your CASIO camera is packed with a powerful selection of features and functions to make recording of digital images easier, including the following three main functions.



Face Detection

Point the camera at a person and it automatically detects the person's face for beautiful portraits every time.

See page **35** for more information.

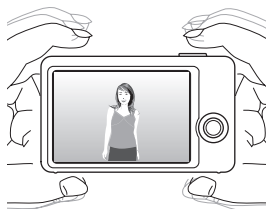

Anti Shake

The camera corrects automatically to minimize image blur due to camera movement and high-speed subject movement.

See page **36** for more information.



BEST SHOT

Simply select the sample scene you want and the camera sets up automatically. Then all you need do is press the shutter button for perfect images.

See page **49** for more information.

First, charge the battery prior to use.

Note that the battery of a newly purchased camera is not charged. Perform the steps under “To charge the battery” to bring the battery to a full charge.

- Your camera requires a special CASIO rechargeable lithium ion battery (NP-82) or an optionally available rechargeable lithium ion battery (NP-80) for power. Never try to use any other type of battery.

To charge the battery

- 1. Positioning the positive \oplus and negative \ominus terminals of the battery with those of the charger unit, load the battery into the charger unit.**

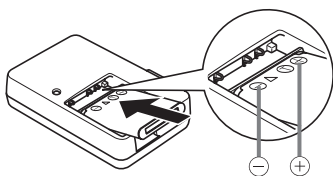

- 2. Plug the charger unit into a household power outlet.**

About 100 minutes are required to reach full charge. The [CHARGE] lamp will go out when charging is complete. Unplug the power cord from the power outlet and then remove the battery from the charger.

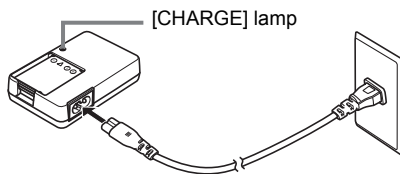

Lamp Status	Description
Lit Red	Charging
Flashing Red	Abnormal ambient temperature, charger problem, or battery problem (page 122)
Off	Charging complete

Other Charging Precautions

- Use the special charger (BC-80L) to charge the special lithium ion battery (NP-82 or NP-80). Never use any other type of charger device. Attempting to use a different charger can result in unexpected accident.
- A battery that is still warm due to normal use may not charge fully. Give the battery time to cool before charging it.
- A battery discharges slightly even when it is not loaded in the camera. Because of this, it is recommended that you charge the battery immediately before you need to use it.
- Charging the camera's battery may cause interference with TV and radio reception. If this happens, plug the charger into an outlet that is further away from the TV or radio.
- Actual charging time depends on current battery capacity and charging conditions.

To load the battery

1. Open the battery cover.

Slide the battery cover slider towards OPEN and then open it as indicated by the arrows in the illustration.

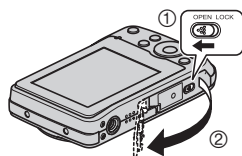

2. Load the battery.

With the EXILIM logo on the battery facing upwards (in the direction of the monitor screen), hold the stopper next to the battery in the direction indicated by the arrow as you slide the battery into the camera. Press the battery in until the stopper secures it in place.

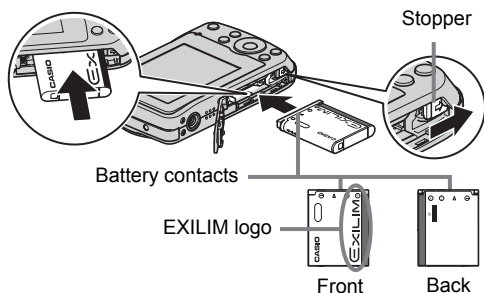

3. Close the battery cover.



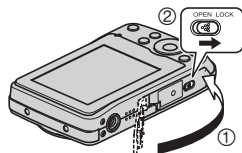

Close the battery cover and then shift the slider towards LOCK.

- For information about how to replace the battery, see page 122.



Checking Remaining Battery Power

As battery power is consumed, a battery indicator on the monitor screen indicates remaining power as shown below.

Remaining Power	High ←————→ Low
Battery Indicator	 →  →  → 
Indicator Color	Cyan → Amber → Red → Red

 indicates battery power is low. Charge the battery as soon as possible.

Recording is not possible when  is indicated. Charge the battery immediately.

- The level shown by the battery indicator may change when you switch between the REC mode and PLAY mode.
- The camera date and time display will not be correct if the camera is left for about two days with no power supplied while the battery is dead. If this happens, load new battery and then set the correct time and date (page 108).
- See page 140 for information about battery life and memory capacity.

Battery Power Conservation Tips

- When you do not need to use the flash, select  (flash off) for the flash setting (page 33).
- Enable the Auto Power Off and the Sleep features to protect against wasting battery power when you forget to turn off the camera (pages 109, 110).

Configuring Basic Settings the First Time You Turn On the Camera

The first time you load a battery into the camera, a screen appears for configuring the display language, date, and time settings. Failure to set the date and time correctly will cause the wrong date and time data to be recorded with images.

IMPORTANT!

- A screen for language selection will not appear in step 2 of the procedure below if you purchased a camera intended for the Japanese market. To change the display language from Japanese in this case, use the procedure under “Specifying the Display Language (Language)” (page 109). Note that a version of this manual in the language you select may not be included with a camera intended for the Japanese market.

1. Press [ON/OFF] to turn on the camera.

2. Use [▲], [▼], [◀], and [▶] to select the language you want and then press [SET].

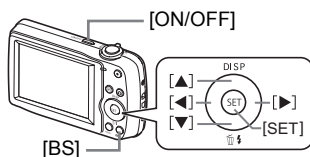

3. Use [▲] and [▼] to select a date style and then press [SET].

Example: 19. 12. 10

YY/MM/DD → 10/12/19

DD/MM/YY → 19/12/10

MM/DD/YY → 12/19/10

4. Set the date and the time.

Use [◀] and [▶] to select the setting you want to change and then use [▲] and [▼] to change it. To switch between 12-hour and 24-hour format, press [BS].



5. After setting the date and time, use [◀] and [▶] to select “Apply” and then press [SET].

If you make a mistake configuring display language, date, or time settings with the above procedure, refer to the following pages for information about how to correct the settings.

- Display language: Page 109
- Date and time: Page 108

NOTE

- Each country controls its local time offset and the use of summer time, and so they are subject to change.
- Removing the battery too soon after you set the time and date can cause the date and time display to become incorrect. Do not remove the battery for at least 24 hours after configuring settings.

Preparing a Memory Card

Though the camera has built-in memory that can be used to store images and movies, you probably will want to purchase a commercially available memory card for greater capacity. The camera does not come with a memory card. Images recorded while a memory card is loaded are saved to the memory card. When no memory card is loaded, images are saved to built-in memory.

- For information about memory card capacities, see page 136.

Supported Memory Cards

- SD Memory Card
- SDHC Memory Card



Use one of the above types of memory card.

To load a memory card

1. Press [ON/OFF] to turn off the camera and then open the battery cover.

Slide the battery cover slider towards OPEN and then open it as indicated by the arrows in the illustration.

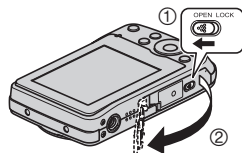

2. Load a memory card.

Positioning the memory card so its front is facing upwards (in the direction of the monitor screen), slide it into the card slot all the way in until you hear it click securely into place.

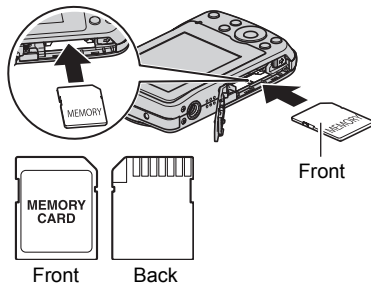

3. Close the battery cover.

Close the battery cover and then shift the slider towards LOCK.

- For information about how to replace the memory card, see page 124.

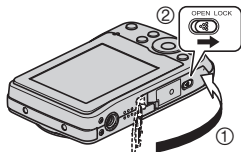

IMPORTANT!

- Never insert anything besides a supported memory card (page 19) into the memory card slot.
- Should water or any foreign object ever get into the card slot, immediately turn off the camera, remove the battery, and contact your retailer or nearest CASIO authorized service center.

To format (initialize) a new memory card

You need to format a new memory card before using it for the first time.

1. Turn on the camera and press [MENU].

2. Select the “Set Up” tab, select “Format” and then press [▶].

3. Use [▲] and [▼] to select “Format” and then press [SET].

IMPORTANT!

- Formatting a memory card that already has snapshots or other files on it, will delete its contents. Normally you do not need to format a memory card again. However, if storing to a card has slowed down or if you notice any other abnormality, re-format the card.
- Be sure to use the camera to format a memory card. Formatting a memory card on a computer and then using it in the camera can slow down data processing by the camera. In the case of an SD or SDHC memory card, formatting on a computer can result in non-conformity with the SD format, causing problems with compatibility, operation, etc.
- Before formatting a new Eye-Fi card to use it for the first time, copy the Eye-Fi Manager install files to your computer. Do this before formatting the card.

Turning the Camera On and Off

To turn power on

To enter the REC mode, press [ON/OFF] (Power) or [RECORD] (REC). To enter the PLAY mode, press [PLAY] (PLAY).

The back lamp will light (green) momentarily and the camera will turn on. If you are entering the REC mode, the lens will extend from the camera at this time.

- Take care to ensure that nothing is restricting or coming into contact with the lens as it extends. Holding the lens with your hand so it cannot extend creates the risk of malfunction.
- Pressing [PLAY] (PLAY) while in the REC mode switches to the PLAY mode. The lens retracts about 10 seconds after switching modes.
- The Sleep function or Auto Power Off (pages 109, 110) will turn off power automatically if you do not perform any operation for a preset amount of time.

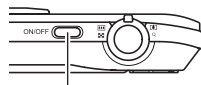

[ON/OFF] (Power)

Back lamp

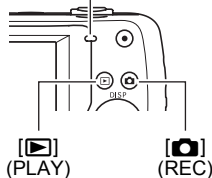

[PLAY] (PLAY)

[RECORD] (REC)

To turn off the camera

Press [ON/OFF] (Power).

- You can configure the camera so power does not turn on when you press [RECORD] (REC) or [PLAY] (PLAY). You also can configure the camera to turn off when you press [RECORD] (REC) or [PLAY] (PLAY) (page 110).

To shoot a snapshot

1. Press [📷] (REC) to turn on the camera.

Make sure  is on the display. If it isn't, see page 49.

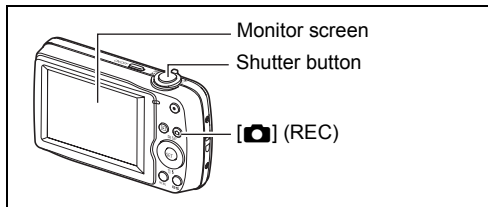
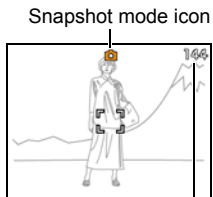

Remaining Snapshot Memory Capacity (page 136)

2. Point the camera at the subject.

You can zoom the image, if you want.

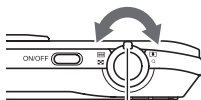

Zoom controller



 Wide Angle



 Telephoto

3. Half-press the shutter button to focus the image.

When focus is complete, the camera will beep, the back lamp will light green, and the focus frame will turn green.

Back lamp

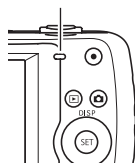

Focus frame

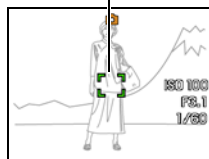

Half-press

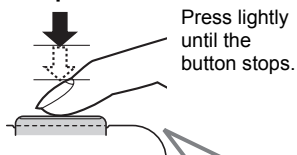

Beep, beep (Image is in focus.)

When you half-press the shutter button, the camera automatically adjusts exposure and focuses on the subject it is currently pointed at. Mastering how much pressure is required for a half-press and a full-press of the shutter button is an important technique for good-looking images.

- The focus frame in the screen shots included in this manual is shown at . Note that you can change the form of the focus frame, if you want (page 57).

4. Continuing to keep the camera still, press the shutter button the rest of the way down.

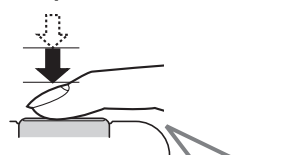

This records the snapshot.

Full-press



Snap (Image is recorded.)

Shooting a Movie

Press  (Movie) to start movie recording. Press  (Movie) again to stop movie recording. See page 45 for details.

 (Movie)



■ If the image does not focus...

If the focus frame stays red and the back lamp is flashing green, it means that the image is not in focus (because the subject is too close, etc.) Re-point the camera at the subject and try to focus again.

■ If the subject is not in the center of the frame...

“Focus lock” (page 56) is the name of a technique you can use when you want to shoot an image in which the subject to be focused on is not within the focus frame in the center of the screen.

Holding the Camera Correctly

Your images will not come out clearly if you move the camera when you press the shutter button. When pressing the shutter button, be sure to hold the camera as shown in the illustration below, and keep it still by pressing your arms firmly against your sides as you shoot.

Holding the camera still, carefully press the shutter button and take care to avoid all movement as the shutter releases and for a few moments after it releases. This is especially important when available lighting is low, which slows down the shutter speed.

Horizontal



Vertical



Hold the camera so the flash is above the lens.

NOTE

- Take care that your fingers and the strap do not cover any of the areas indicated in the illustration.
- To protect against accidentally dropping the camera, attach the wrist strap and make sure it is around your fingers or wrist while you are operating the camera.
- Never swing the camera around by its strap.
- The supplied strap is intended for use with this camera only. Never use it for any other purpose.

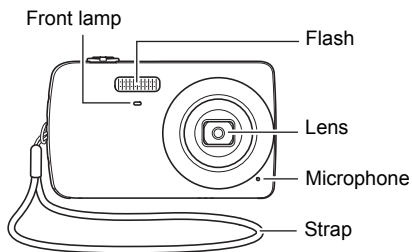

Viewing Snapshots

Use the following procedure to view snapshots on the camera's monitor screen.

- For information about how to play back movies, see page 68.

1. Press **[▶]** (PLAY) to enter the **PLAY mode.**

- This will display one of the snapshots currently stored in memory.
- Information about the displayed snapshot also is included (page 12).
- You also can clear the information to view only the snapshot (page 113).
- You can zoom in on the image by sliding the zoom controller towards **[📏]** (page 69). If you are recording a snapshot that is very important to you, it is recommended that you zoom the image and check its details after recording it.

[▶] (PLAY)

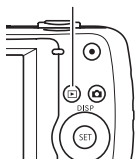

2. Use **[◀]** and **[▶]** to scroll between images.

- Holding down either button scrolls at high speed.



NOTE

- Half-pressing the shutter button while in the PLAY mode or while a menu screen is displayed will switch directly to the REC mode.

Deleting Images

If memory becomes full, you can delete images you no longer need to free up storage and record more images.



IMPORTANT!

- Remember that a file (image) delete operation cannot be undone.
- Deleting an audio snapshot (page 75) deletes both the snapshot and the audio file.

To delete a single file

1. Press [▶] (PLAY) to enter the PLAY mode and then press [▼] (🗑️ ⚡).



2. Use [◀] and [▶] to scroll through the files until the one you want to delete is displayed.

3. Use [▲] and [▼] to select “Delete” and then press [SET].
 - To delete other files, repeat steps 2 and 3.
 - To exit the delete operation, press [MENU].

To delete all files

1. Press [▶] (PLAY) to enter the PLAY mode and then press [▼] (🗑️ ⚡).
2. Use [▲] and [▼] to select “Delete All Files” and then press [SET].
3. Use [▲] and [▼] to select “Yes” and then press [SET] to delete all files. This will cause the message “There are no files” to appear.

Snapshot Shooting Precautions

Operation

- Never open the battery cover while the back lamp is flashing green. Doing so can result in the image you just shot being saved incorrectly, damage to other images stored in memory, malfunction of the camera, etc.
- If unwanted light is shining directly onto the lens, shade the lens with your hand when shooting an image.

Monitor Screen when Shooting Snapshots

- Subject brightness conditions can cause monitor screen response to slow and can cause digital noise in the monitor screen image.
- The image that appears on the monitor screen is for image composition. The actual image will be recorded at the quality set for the image quality setting (page 64).

Shooting Indoors under Fluorescent Lighting

- Minute flickering of fluorescent lighting can affect the brightness or color of an image.

Auto Focus Restrictions

- Any of the following can make proper focus impossible.
 - Solid color wall or other very low contrast subject
 - Strongly back lit subject
 - Very shiny subject
 - Blinds or other subject with a repeating horizontal pattern
 - Multiple subjects at varying distances from the camera
 - Subject in a dark location
 - Camera movement while shooting
 - Fast-moving subject
 - Subjects outside the focus range of the camera
- If you cannot focus properly, try using focus lock (page 56) or Manual Focus (page 54).

Using the Control Panel

The Control Panel can be used to configure camera settings.

1. In the REC mode, press [SET].

This will cause a Control Panel to appear along the right side of the monitor screen. The settings available for the currently selected Control Panel also appear. You can use the control panel to configure various camera settings.

- If "On" is selected for the Panel setting (page 104), the Control Panel is always displayed along the right side of the monitor screen.

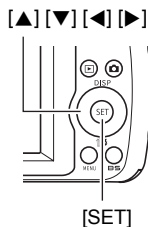

2. Use [▲] and [▼] to select the setting you want to change.

- 1 Image size/Quality* (pages 30, 64)
- 2 Flash (page 33)
- 3 Face detection (page 35)
- 4 Anti shake (page 36)
- 5 ISO sensitivity (page 37)
- 6 White balance (page 37)
- 7 EV shift (page 39)
- 8 easy Mode (page 40)
- 9 Date/Time (page 42)

Available settings

Control Panel

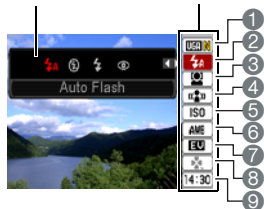

- * Snapshot image quality cannot be changed using the Control Panel.

3. Use [◀] and [▶] to change the setting.

4. If you want to configure another setting, repeat steps 2 and 3.

5. After all of the settings are the way you want, press [SET].

This will apply the settings and return to the REC mode.

NOTE

- You also can configure settings other than those listed above (page 52).
- The Control Panel cannot be displayed while an easy Mode, For YouTube, or Voice Recording Operation is in progress.

Changing the Image Size (Size)

■ Pixels

A digital camera image is a collection of small dots called "pixels". The more pixels there are in an image, the more detail there will be. However, you generally can do with fewer pixels when printing an image (L size) through a print service, attaching an image to e-mail, when viewing the image on a computer, etc.

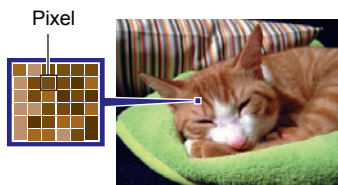

■ About image sizes

The size of an image indicates how many pixels it contains, and is expressed as horizontal pixels×vertical pixels.

7M (3072×2304) size image =
Approximately 7 million pixels

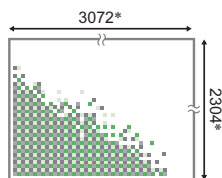

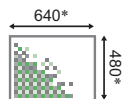

VGA (640×480) size image =
Approximately 300,000 pixels



* Unit: pixels

Image Size Selection Tips

Note that larger images have more pixels, so they take up more memory space.

Large Number of Pixels	More detail, but takes up more memory. Best when you plan to print large-size prints (such as A3 size).	
Small Number of Pixels	Less detail, but takes up less memory. Best when you want to send images by e-mail, etc.	

- For information about image size, image quality, and number of images that can be stored, see page 136.
- For information about movie image size, see page 65.
- For information about resizing existing snapshots, see page 74.

■ To select the image size

1. In the REC mode, press [SET].

2. Use [▲] and [▼] to select the top Control Panel option (Image Size).

3. Use [◀] and [▶] to select an image size and then press [SET].

Image Size (Pixels)	Suggested Print Size and Application	Description
10M (3648×2736)	Poster Print	Good detail for better clarity even for images cropped (page 75) from the original
3:2 (3648×2432)	Poster Print	
16:9 (3648×2048)	HDTV	
7M (3072×2304)	A3 Print	Good detail
4M (2304×1728)	A4 Print	
2M (1600×1200)	3.5"×5" Print	Best when preserving memory capacity is relatively more important than image quality.
VGA (640×480)	E Mail	Image files are smaller, which is better when attaching images to e-mail. However, images are relatively coarser.

- The initial factory default image size setting is "10M".
- Selecting "3:2" records images with an aspect ratio of 3:2, which matches the standard aspect ratio of print paper.
- The letters "HDTV" stand for "High Definition Television". An HDTV screen has an aspect ratio of 16:9, which makes them wider than the usual 4:3 aspect ratio of television screens of the past. Your camera can record images that are compatible with the aspect ratio an HDTV screen.
- You should regard the print paper sizes suggested here as guidelines only (200 dpi print resolution).





Using Flash (Flash)

1. In the REC mode, press [▼] () to select the flash setting you want.

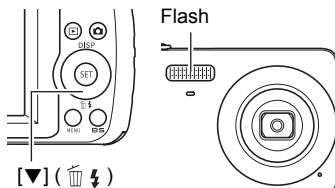
Each press of [▼] () cycles through the available flash settings.

- If “On” is selected for the Panel setting (page 104), you can change the flash setting by pressing [▼] () once, using [◀] and [▶] to select the setting, and then pressing [SET].



 Auto Flash	Flash fires automatically in accordance with exposure (amount of light and brightness) conditions.
 Flash Off	Flash does not fire.
 Flash On	Flash always fires. This setting can be used to brighten a subject that normally comes out dark due to daylight or backlight (daylight synchro flash).
 Red Eye	Flash fires automatically. This type of flash can be used to reduce the chance of redness in the subject's eyes.

2. Press the shutter button to shoot.

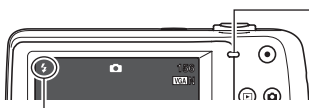

 indicates the flash will fire.

Back lamp

Flashes orange while the flash is charging to indicate that image recording is disabled.

- You will not be able to take another flash snapshot until the lamp stops flashing orange, which indicates that charging is complete.

- For information about Flash Range, see page 139.

NOTE

- Take care so your fingers and the strap do not block the flash.
- The desired effect may not be obtained when the subject is too far away or too close.
- Flash charging time (page 139) depends on operating conditions (battery condition, ambient temperature, etc.)
- Shooting with flash turned off when lighting is dim results in a slow shutter speed, which can cause image blur due to camera movement. Under such conditions, secure the camera with a tripod, etc.
- With red eye reduction, the flash is fired automatically in accordance with exposure. It does not fire in areas where lighting is bright.
- The presence of outdoor sunlight, fluorescent lighting, or some other light source can cause abnormal image colors.
- Select  (Flash Off) for the flash setting when shooting in areas where flash photograph is prohibited.

Red-eye Reduction

Using the flash to shoot at night or in a dimly lit room can cause red spots inside the eyes of people who are in the image. This is caused when the light from the flash reflects off of the retina of the eye. When red-eye reduction is selected as the flash mode, the camera fires a pre-flash to cause the irises in the eyes of any people in the image to close, which reduces the chance of red eye.

Note the following important points when using red-eye reduction.

- Red-eye reduction does not work unless the people in the image are looking directly at the camera (flash).
- Red-eye reduction may not work very well if the subjects are located far away from the camera.

Other Useful Flash Features

- Changing the flash intensity (page 67)

Using Face Detection (Face Detection)

The face detection feature adjusts focus and brightness to the faces in the image.

- 1. In the REC mode, press [SET].**

- 2. Use [▲] and [▼] to select the third Control Panel option from the top (Face Detection).**

- 3. Use [◀] and [▶] to select “ Face Detection: On” and then press [SET].**

- 4. Point the camera at the subject(s).**

The camera will detect human faces and display a frame around each one.

- 5. Half-press the shutter button.**

The camera will focus and the frames around the faces it focuses on will turn green.

- 6. Press the shutter button the rest of the way down.**



Tips for Best Face Detection Results

- The camera performs center focus if it cannot detect a face.
- Always make sure that Auto Focus (AF) is selected as the focus mode when shooting with face detection.
- Face detection may take a bit longer when you hold the camera sideways.
- Detection of the following types of faces is not supported.
 - Face that is obstructed by hair, sunglasses, a hat, etc., or a face in dark shade
 - A profile or a face that is at an angle
 - A face that is very far away and small, or very close and large
 - A face in an area that is very dark
 - The face of a pet or some other non-human subject

IMPORTANT!

- Face detection cannot be used in combination with any of the following features.
 - Some BEST SHOT scenes (For YouTube, Voice Recording)
 - easy Mode
 - Movie Recording
- The following function is disabled when shooting with face detection.
 - Multi AF

Reducing the Effects of Camera and Subject Movement (Anti Shake)

You can turn on the camera's Anti Shake feature to reduce image blur due to subject movement or camera movement when shooting a moving subject using telephoto, when shooting a fast-moving subject, or when shooting under dim lighting conditions.

- 1. In the REC mode, press [SET].**

- 2. Use [▲] and [▼] to select the fourth Control Panel option from the top (Anti Shake).**

- 3. Use [◀] and [▶] to select the setting you want and then press [SET].**

Auto	Minimizes the effects of hand and subject movement.
Off	Turns off Anti Shake settings

NOTE

- ISO sensitivity, aperture, and shutter speed do not appear on the monitor screen when you half-press the shutter button while "Auto" is selected. These values will appear briefly, however, in the preview image that is displayed immediately after you shoot a snapshot.
- If the flash fires, the Anti Shake icon  will remain on the display, even though Anti Shake does not function during flash photography.
- The ISO sensitivity setting (page 37) must be "AUTO" for Anti Shake to work.
- Shooting with Anti Shake can cause an image to appear somewhat coarser than normal and can cause slight deterioration of image resolution.
- Anti Shake may not be able to eliminate the effects of camera or subject movement when movement is severe.
- Anti Shake is disabled during movie recording.

Specifying ISO Sensitivity (ISO)

ISO sensitivity is a measure of sensitivity to light.

1. In the REC mode, press [SET].
2. Use [▲] and [▼] to select the fifth Control Panel option from the top (ISO Sensitivity).
3. Use [◀] and [▶] to select the setting you want and then press [SET].

AUTO	Adjusts sensitivity automatically according to conditions		
ISO 64	Lower sensitivity	Slow shutter speed	Less noise
ISO 100	↑ ↓	↑ ↓	↑ ↓
ISO 200			
ISO 400			
ISO 800			
ISO 1600			
	Higher sensitivity	Fast shutter speed (Set for shooting in dimly lit areas.)	Some coarseness (increased digital noise)

- “AUTO” ISO sensitivity always is applied for movies, regardless of the current ISO sensitivity setting.

Adjusting White Balance (White Balance)

You can adjust white balance to match the source of light available where you are shooting and avoid the blue cast that results when shooting outdoors when it is cloudy, and the green cast that results when shooting under fluorescent lighting.

1. In the REC mode, press [SET].
2. Use [▲] and [▼] to select the sixth Control Panel option from the top (White Balance).

3. Use [◀] and [▶] to select the shooting condition you want and then press [SET].

AWB Auto WB	Configures the camera to adjust white balance automatically
☀ Daylight	For shooting outdoors on a clear day
☁ Overcast	For shooting outdoors on an overcast rainy day, in the shade, etc.
🌳 Shade	For shooting on a clear day in the shade of trees or buildings
☀N Day White Fluorescent	For shooting under white or day white fluorescent lighting
☀D Daylight Fluorescent	For shooting under daylight fluorescent lighting
💡 Tungsten	For shooting under light bulb lighting
MWB Manual WB	<p>For configuring the camera manually to suit a particular light source.</p> <p>① Select “MWB Manual WB”.</p> <p>② Under the lighting conditions you plan to use when shooting, point the camera at a blank white piece of paper so it fills the entire monitor screen and then press the shutter button.</p> <p>③ Press [SET].</p> <p>The white balance setting is retained even if you turn off the camera.</p>

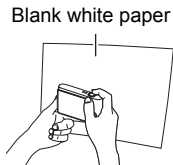

- When “**AWB Auto WB**” is selected for the white balance setting, the camera automatically determines the white point of the subject. Certain subject colors and light source conditions can cause problems when the camera tries to determine the white point, which makes proper white balance adjustment impossible. If this happens, select the white balance setting that matches your shooting conditions (Daylight, Overcast, etc.)

Correcting Image Brightness (EV Shift)

You can manually adjust an image's exposure value (EV value) before shooting it.

- Exposure Compensation Range: -2.0EV to $+2.0\text{EV}$
- Unit: $1/3\text{EV}$

1. In the REC mode, press [SET].

2. Use [▲] and [▼] to select the third Control Panel option from the bottom (EV Shift).

3. Use [◀] and [▶] to adjust the exposure compensation value.

[▶]: Increases the EV value. A higher EV value is best for light-colored subjects and backlit subjects.

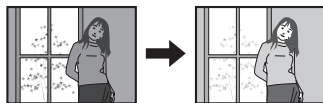

[◀]: Decreases the EV value. A lower EV value is best for dark-color subjects and for shooting outdoors on a clear day.

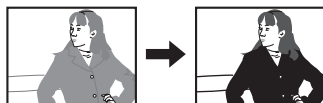

To cancel exposure compensation, change the EV value to 0.0.



Exposure compensation value

4. Press [SET].

This applies the exposure compensation value. The exposure compensation value you set remains in effect until you change it.

NOTE

- When shooting under very dark or very bright conditions, you may not be able to obtain satisfactory results even after performing exposure compensation.

Using the easy Mode

The easy mode eliminates troublesome setups and simplifies snapshot recording. This mode is recommended for those who are new to digital imaging.

1. In the REC mode, press [SET].

2. Use [▲] and [▼] to select the second Control Panel option from the bottom (easy Mode).

3. Use [◀] and [▶] to select “☒ On” and then press [SET].
This enters the easy mode.

4. Focus the image.
While the focus frame is aligned with the subject, half-press the shutter button.

5. Shoot the image.
When the image is focused, press the shutter button the rest of the way.
This records the snapshot.

■ Using the easy Menu

The easy menu contains flash, self-timer, and image size settings, plus an item for exiting the easy mode.

While the camera is in the easy mode, all the other settings (besides Flash, Self-timer, Image Size, and easy Mode) on the REC tab menu (page 127) and Quality tab menu (page 127) are fixed at preset optimum values. Any settings you configured on these tabs are not used in the easy mode.

IMPORTANT!

- To use the Set Up tab menu (page 128), you need to exit the easy mode. To do this, select the “easy Mode” item in step 2 of the following procedure, and then select **OFF** in step 3. After that, you can use the Set up tab menu as you normally do.

1. Press [MENU].

The easy menu displays larger text than standard menus.

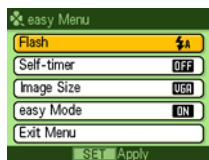

2. Use [▲] and [▼] to select the menu item you want, and then press [SET].

3. Use [▲] and [▼] to select the setting you want, and then press [SET].

Menu Item:	Available Settings:
Flash	(Auto Flash)* / (Flash On) / (Flash Off)
Self-timer	(10-second self-timer) / OFF *
Image Size	10M * / 4M / UGA
easy Mode	ON / OFF *
Exit Menu	Exit the easy menu

- An asterisk (*) indicates reset default settings.
- See the following for details.
 - Flash (page 33)
 - Self-timer (page 59)
 - Image Size (page 30)
- The following are the settings you can select for “easy Mode”.

To do this:	Select this setting:
Stay in the easy mode, without switching to another recording type	ON
Switch from the easy mode to a standard recording type	OFF

- On-screen pop-up help text provides a brief explanation of each setting.

Changing the Control Panel Date/Time Style

1. In the REC mode, press [SET].
2. Use [▲] and [▼] to select the bottom Control Panel option (Date/Time).
Use [◀] and [▶] to select the date or time.

NOTE

- You can select either of two display style (page 108) for the date: Month/Day or Day/Month.
- The time is displayed using 24-hour format.

Shooting with Zoom

Your camera provides you with 3X optical zoom (that changes the lens focal distance), which can be used in combination with digital zoom (that digitally processes the center portion of the image to enlarge it) for total zoom capabilities of 3X to 45.2X. The image deterioration point depends on the image size (page 44).

1. In the REC mode, slide the zoom controller to zoom.



 Wide Angle



 Telephoto

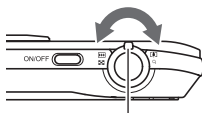

Zoom controller

 (Wide Angle) : Reduces the size of the subject and broadens the range

 (Telephoto) : Enlarges the subject and narrows the range

2. Press the shutter button to shoot the image.



IMPORTANT!

- Digital zoom is disabled while date stamping (page 107) is turned on.

NOTE

- The higher the digital zoom factor, the coarser the recorded image. Note that the camera also has a function that lets you record using digital zoom without image deterioration (page 43).
- Use of a tripod is recommended to protect against image blur due to camera movement when shooting with telephoto.
- Performing a zoom operation changes the lens aperture.
- Digital zoom only is available during movie recording. You can adjust the optical zoom setting before you press the shutter button to start movie recording.

Optical Zoom and Digital Zoom Switch Point

If you hold the zoom controller towards  (Telephoto), the zoom operation will stop when the optical zoom factor reaches its maximum. Momentarily releasing the zoom controller and then holding it again towards  (Telephoto) will switch to digital zoom, which you can use to set an even higher zoom factor.

- During zoom, a zoom bar on the monitor screen shows the current zoom setting.

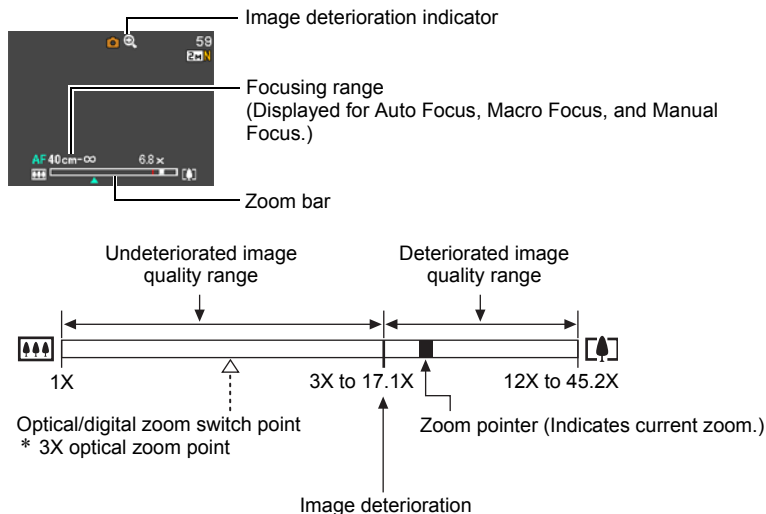

- The image deterioration point depends on the image size (page 30). The smaller the image size, the higher the zoom factor you can use before reaching the image deterioration point.
- Though digital zoom generally causes a deterioration of image quality, some digital zoom without image deterioration is possible with image sizes of "7M" and smaller. The range in which you can use digital zoom without image deterioration is indicated on the display. The deterioration point depends on the image size.

Image Size	Maximum Zoom Factor	Undeteriorated zoom limit
10M	12X	3X
3:2	12X	3X
16:9	12X	3X
7M	14.2X	3.6X
4M	18.7X	4.7X
2M	26.5X	6.8X
VGA	45.2X	17.1X

Recording Movie Images and Audio

To record a movie

1. Configure the quality setting for the movie (page 65).

The length of the movie you can record will depend on the quality setting you select.

2. In the REC mode, press [●] (Movie).

This will start recording and display  on the monitor screen.

Movie recording includes monaural audio.

Remaining recording time
(page 137)

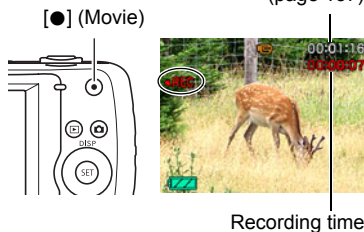

3. Press [●] again to stop recording.

- Each movie can be up to 10 minutes long. Movie recording stops automatically after 10 minutes of recording. Movie recording also will stop automatically if memory becomes full before you stop movie recording by pressing [●].

Shooting with BEST SHOT

With BEST SHOT (page 49), you can select the sample scene that matches the type of movie you are trying to shoot and the camera will change its setup accordingly, for beautiful movies every time. Selecting the BEST SHOT scene named Night Scene, for example, will configure the camera so night scenes appear clearer and brighter.

NOTE

- Spending a long time using movie recording will cause the camera to become slightly warm to the touch. This is normal and does not indicate malfunction.
- The camera also records audio. Note the following points when shooting a movie.
 - Take care that the microphone is not blocked by your fingers, etc.
 - Good recording results are not possible when the camera is too far away from what you are trying to record.
 - Operating camera buttons while shooting can cause button noise to be picked up in the audio.
- Shooting a very bright subject can cause a vertical band to appear in the monitor screen image. This does not indicate malfunction. The band will not be recorded in a snapshot, but will be recorded in the case of a movie.
- Use of certain types of memory cards increase the time it takes to record movies, which can cause movie frames to be lost. This condition is indicated by **MC** and **REC** flashing on the monitor screen. To avoid loss of movie frames, use of a memory card with a maximum transfer speed of at least 10MB per second is recommended (page 125).
- Only digital zoom can be used for zooming during movie recording. Since optical zoom is not possible while recording a movie, zoom as required before pressing **[●]** to start recording.
- The effects of camera movement in an image become more pronounced when you shoot close up or with a large zoom factor. Because of this, use of a tripod is recommended under these conditions.
- Auto Focus and Macro Focus become fixed focus while shooting a movie (page 54).

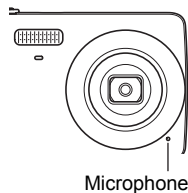

Shooting a Snapshot while Shooting a Movie

1. While a movie is being recorded, press the shutter button.

Movie recording continues after the snapshot is recorded.

NOTE

- You can use [▼] () while shooting a movie to change the flash mode setting.
- Movie recording is interrupted for a few seconds at the point where a snapshot is recorded.
- Shooting a snapshot during movie recording is not possible while any one of the following BEST SHOT scenes is selected.
For YouTube, Voice Recording

Recording Audio Only (Voice Recording)

Voice Recording lets you record audio only, without a snapshot or movie.

- For information about Voice Recording capacities, see page 137.

1. In the REC mode, press [BS].

2. Use [▲], [▼], [◀], and [▶] to select the (Voice Recording) scene and then press [SET].

This causes  to appear on the monitor screen.

3. Press the shutter button to start recording.

- The back lamp flashes green while recording is in progress.
- Pressing [SET] during recording will insert a marker into the recording. During playback, you will be able to jump to the markers in the recording.

4. Press the shutter button again to stop audio recording.

- To create another audio recording file, repeat steps 3 and 4.
- To turn off Voice Recording, press [BS] and then select  (Auto).

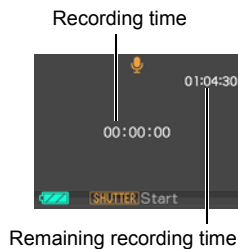

NOTE

- You can use [▲] (DISP) during audio recording to toggle the monitor screen on and off.
- When monitor screen contents are turned off, selecting the “Voice Recording” scene will cause the monitor screen to turn off immediately (page 113).

About audio data

- Audio files can be played back on a computer using Windows Media Player or QuickTime (pages 89, 98)
 - Audio Data: WAVE/IMA-ADPCM (WAV extension)

To play back an audio recording

1. In the PLAY mode, use [◀] and [▶] to display the Voice Recording file you want to play.

 is displayed in place of an image for a Voice Recording file.



2. Press [SET] to start playback.

Voice Recording Playback Controls

Fast forward/fast reverse	[◀] [▶]
Play/pause	[SET]
Jump to marker	While playback is paused, press [◀] or [▶] to jump to the next marker and then press [SET] to resume playback.
Volume adjustment	Press [▼] and then press [▲] [▼]
Monitor screen on/off	[▲] (DISP)
Playback end	[MENU]

Using BEST SHOT

What is BEST SHOT?

BEST SHOT provides you with a collection of sample “scenes” that show a variety of different types of shooting conditions. When you need to change the setup of the camera, simply find the scene that matches what you are trying to achieve, and the camera sets up for it automatically. This helps to minimize the chance of ruined images due to poor exposure and shutter speed settings.

Some Sample Scenes

			
Portrait	Scenery	Night Scene	Night Scene Portrait



To shoot an image with BEST SHOT

1. In the REC mode, press [BS].

This will display a menu of BEST SHOT scenes.

- The initial default selection is  (Auto).

2. Use [▲], [▼], [◀], and [▶] to move the boundary to the scene you want to select.

- The scene menu has multiple pages. Use [▲] and [▼] to scroll between menu pages.
- You can access information about the currently selected scene. See page 50 for details.
- To return to normal snapshot recording, select Scene 1  (Auto). Pressing [MENU] while the scene selection screen or scene information screen is displayed will cause the boundary to jump directly to  (Auto).

Currently selected scene
(with boundary)

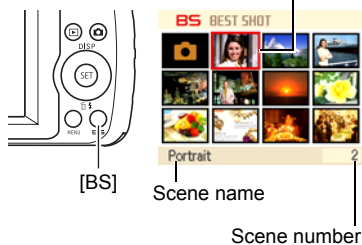

3. Press [SET] to configure the camera with the settings for the currently selected scene.

This returns to the REC mode.

- The settings of the scene you selected remain in effect until you select a different scene.
- To select a different BEST SHOT scene, repeat the above procedure from step 1.

4. Press the shutter button.

NOTE

- The BEST SHOT YouTube scene sets up the camera for recording movies that are optimized for uploading to YouTube. Movies recorded with the YouTube scene are stored in a special folder to make them easy to locate for uploading (page 102). Maximum recording time while the YouTube scene is selected is 10 minutes.

■ Using Scene Information Screen

To find out more about a scene, select it with the boundary on the scene selection screen, and then slide the zoom controller in either direction.

- To return to the scene menu, slide the zoom controller again.
- To scroll between scenes, use [◀] and [▶].
- To configure the camera with the settings for the currently selected scene, press [SET]. To return to the scene information screen for the currently selected BEST SHOT scene, press [BS].

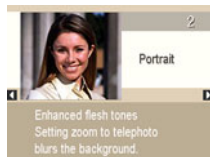

■ BEST SHOT Precautions

- Some scenes like Night Scene and Fireworks result in a slow shutter speed setting. Since a slow shutter speed increases the chance of digital noise in the image, the camera automatically performs a digital noise reduction process when either of these scenes is selected. This means that it will take a bit longer for the image to be saved which is indicated by the back lamp flashing green. Do not perform any key operation during that time. Also, it is a good idea to use a tripod to avoid image blur due to camera movement when shooting at slow shutter speeds.
- Your camera includes a sample scene that optimizes settings for auction site images. Depending on your camera model, the sample scene is named either “For eBay” or “Auction”. Images you record using the auction site sample scene are stored in a special folder so you can easily find them on your computer (page 102). When using this feature, image size is fixed at 2M (1600×1200 pixels).
- High Sensitivity
 - The high sensitivity setting is disabled whenever the camera's flash fires.
 - High sensitivity may not produce the desired results in very dark conditions.
 - When shooting with slow shutter speeds, use a tripod to protect against blurring due to camera movement.
 - Under certain lighting conditions, the camera will perform an automatic noise filtering operation to reduce digital noise in the image. This operation causes the camera to take longer than normal to save the image and be ready for the next shot.
- BEST SHOT scene images were not shot using this camera.
- Images shot using a BEST SHOT scene may not produce the results you expected due to shooting conditions and other factors.
- You can modify the camera settings that are made after you select a BEST SHOT scene. Note, however, that the BEST SHOT settings revert to their defaults when you select another BEST SHOT scene or turn off the camera.

Advanced Settings

The following are menu operations you can use to configure various camera settings.

- You also can use the Control Panel (page 29) to configure some of the settings that appear on the menu screen. Refer to the page references provided in this section for information about configuring settings using the Control Panel.

Using On-screen Menus

■ Example Menu Screen Operation

Press [MENU] to display the menu screen.

- Menu contents are different in the REC mode and PLAY mode.

Example: REC mode menu



[▲] [▼] [◀] [▶]

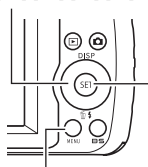

[MENU]

[SET]

Menu Screen Operation Buttons

[◀] [▶]	Selects tabs. [▶] is also used to display the options available for a setting.
[▲] [▼]	Selects a setting option.
[SET]	Registers the selected setting.
[MENU]	Exits the menu screen.

NOTE

- Pressing the shutter button while the REC menu screen is displayed will cancel the current menu operation and exit the menu screen.

1. In the REC mode, press [MENU].

This will display the menu screen.

2. Use [◀] and [▶] to select the tab where the item you want to configure is located.

3. Use [▲] and [▼] to select the menu item you want, and then press [▶].

4. Use [▲] and [▼] to change the setting.

5. After the setting is the way you want, press [SET].

- Pressing [◀] registers the selected setting and returns to the menu.
- To configure settings on another tab after pressing [◀] to return to the menu, use [▲] to move the highlighting up to the tabs, and then use [◀] and [▶] to select the tab you want.

Example:
When "Focus" is selected on the "REC" tab



■ Menu Operations in This Manual

Menu operations are represented in this manual as shown below. The following operation is the same one described under "Example Menu Screen Operation" on page 52.

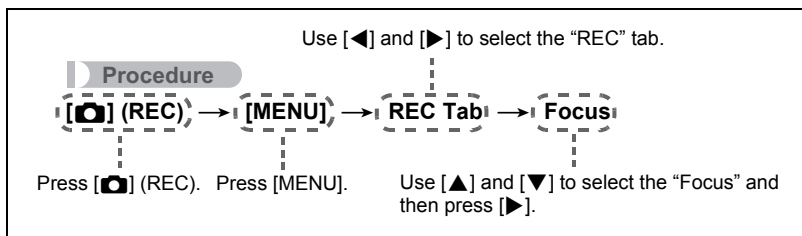





REC Mode Settings (REC)

Selecting a Focus Mode (Focus)

Procedure

[] (REC) → [MENU] → REC Tab → Focus

Settings	Type of Shot	Focus Mode		Approximate Focus Range* ¹	
		Snapshot	Movies	Snapshot	Movies
 Auto Focus	General recording	Automatic	* ²	Approximately 10 cm to ∞ (infinity) (3.9" to ∞)	* ²
 Macro	Close ups	Automatic	Fixed focal point	Approximately 10 cm to 50 cm (3.9" to 19.7")	Fixed distance * ³ , * ⁵
 Pan Focus	Shooting with a relatively wide focus range	Fixed focal point		Fixed distance* ³ , * ⁴	
 Infinity	Scenery and other distant subjects	Fixed		Infinity	
 Manual Focus	When you want to focus manually	Manual		Approximately 10 cm to ∞ (infinity)* ³ (3.9" to ∞)	

*¹ The focus range is the distance from the lens surface.

*² During movie recording, the Auto Focus mode is disabled.

*³ The minimum changes along with the optical zoom setting.

*⁴ The distance depends on shooting conditions, and appears on the monitor screen when the shutter button is half-pressed.

Zoom Steps	Normal		Macro
	Close Up	Telephoto	Center distance
Z1 (Wide)	Approx. 0.71 (2.3')	∞	0.30 (11.8")
2	Approx. 0.94 (3.1')	∞	0.30 (11.8")
3	Approx. 1.33 (4.4')	∞	0.30 (11.8")
4	Approx. 1.74 (5.7')	∞	0.32 (12.6")
5	Approx. 1.95 (6.4')	∞	0.35 (13.8")
6	Approx. 3.09 (10.1')	∞	0.40 (15.7")
7 (Tele)	Approx. 3.51 (11.5')	∞	0.45 (17.7")

NOTE

- Above values are for reference only.
For movie macro, the focus range is a few centimeters within the center distance.

To focus with manual focus

1. On the monitor screen, compose the image so the subject you want to focus on is within the yellow boundary.

2. Watching the image on the monitor screen use [◀] and [▶] to adjust focus.

- At this time the image that is within the boundary will enlarge and fill the monitor screen, which aids in focusing. If you do not perform any operation for two seconds while the enlarged image is displayed, the screen in step 1 will re-appear.

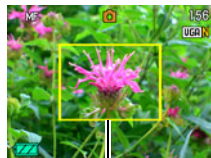

Yellow boundary

NOTE

- An Auto Macro feature detects how far the subject is from the lens and automatically selects either Macro Focus or Auto Focus accordingly.
- Use of the flash together with Macro Focus can cause the light of the flash to become blocked, which may result in unwanted lens shadows in your image.
- Auto Macro can be used when recording snapshots only.
- Whenever you perform an optical zoom operation while shooting with Auto Focus, Macro Focus, or Manual Focus, a value will appear on the monitor screen to tell you the focus range, as shown below.
Example: ○○ cm to ∞
- * ○○ is the actual focusing range value.
- The operations assigned to the [◀] and [▶] keys with the “L/R Key” setting (page 61) are disabled while Manual Focus is selected as the focus mode.

Using Focus Lock

“Focus lock” is a technique you can use when you want to compose an image in which the subject you want to focus on is not within the focus frame in the center of the screen.

- To use focus lock, select “[] Spot” for the Auto Focus area (page 60).

1. Align the monitor screen’s focus frame with the subject you want to focus on and then half-press the shutter button.

Subject to be focused on

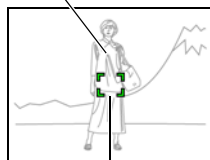

Focus frame

2. Keeping the shutter button half-pressed (which maintains the focus setting), move the camera to compose the image.

3. When you are ready to shoot the image, press the shutter button the rest of the way down.



NOTE







- Focus lock also locks exposure (AE).

Changing the Focus Frame Shape (Focus Frame)

Procedure

[] (REC) → [MENU] → REC Tab → Focus Frame

You can use this procedure to select from among seven different shapes, including a heart shape, for the focus frame.

Settings							
-----------------	---	---	---	---	---	---	---

NOTE

- Half-pressing the shutter button will cause the focus frame to change one of the shapes shown below.

Focus successful						
Focus not successful						

- When shooting with face detection or the easy mode, the frame shape is .

Using Continuous Shutter (CS)

Procedure

[] (REC) → [MENU] → REC Tab → CS

While Continuous Shutter is turned on, images are continually recorded until memory becomes full, as long as you keep the shutter button depressed.

Releasing the shutter button stops shooting.

NOTE



- With continuous shutter, exposure and focus for the first image are applied for successive images as well.
- Continuous shutter cannot be used in combination with any of the following.
 - Some BEST SHOT scenes (For YouTube, Voice Recording)
 - easy Mode
 - Movie Recording
- When using a continuous shutter mode, keep the camera still until all recording is finished.
- The continuous shutter rate depends on the current image size and image quality settings.
- The speed of Continuous Shutter depends on the type of memory card loaded in the camera and the amount of free space available for storage. When shooting to built-in memory, continuous shutter shooting is relatively slow.
- You cannot use the self-timer in combination with Continuous Shutter.

Using the Self-timer (Self-timer)

Procedure

[] (REC) → [MENU] → REC Tab → Self-timer

With the Self-timer, pressing the shutter button starts a timer. The shutter is released and the image is shot after a fixed amount of time.

 10 sec	10-second Self-timer
 2 sec	2-second Self-timer • When shooting under conditions that slow down the shutter speed, you can use this setting to prevent image blur due to camera movement.
 X3 (Triple Self-timer)	Shoots three images: one image 10 seconds after the shutter button is pressed, and the next two images as soon as the camera is ready after shooting the previous image. How long it takes for the camera to get ready to shoot depends on the image size and quality settings, whether or not a memory card is loaded in the camera, and the flash charge condition.
Off	Turns off the Self-timer.

- The front lamp flashes while the Self-timer countdown is in progress.
- You can interrupt an ongoing Self-timer countdown by pressing [SET].

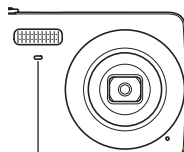

Front lamp

NOTE

- The Self-timer cannot be used together with the following features.
Continuous Shutter, certain BEST SHOT scene (Voice Recording)
- The Triple Self-timer cannot be used together with the following feature.
 - BEST SHOT scene (For YouTube)
 - easy Mode
 - Movie Recording

Shooting with Face Detection (Face Detection)

Procedure

[] (REC) → [MENU] → REC Tab → Face Detection

For details, see the Control Panel procedure on page 35.

Reducing the Effects of Camera and Subject Movement (Anti Shake)

Procedure

[] (REC) → [MENU] → REC Tab → Anti Shake

For details, see the Control Panel procedure on page 36.

Specifying the Auto Focus Area (AF Area)

Procedure

[] (REC) → [MENU] → REC Tab → AF Area

Spot	This mode takes readings of a small area in the center of the image. This setting works well with focus lock (page 56).
Multi	When you half-press the shutter button while this setting selected, the camera will select the optimum Auto Focus area from among nine possible areas. The focus frame of the area where the camera focuses will be displayed in green.

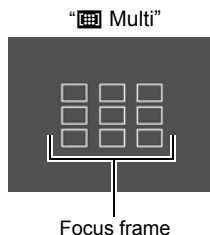
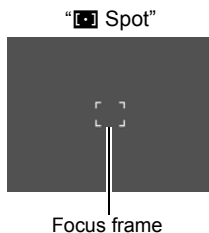

- “ Multi” cannot be selected for the Auto Focus area while you are using Face Detection (page 35).

Using the easy Mode (easy Mode)

Procedure

[] (REC) → [MENU] → REC Tab → easy Mode

For details, see the Control Panel procedure on page 40.

Assigning Functions to the [◀] and [▶] Keys (L/R Key)

Procedure

[] (REC) → [MENU] → REC Tab → L/R Key

You can assign one of the five functions listed below to the [◀] and [▶] keys.

Setting	[◀]/[▶] key operation
Metering	Changes the Metering Mode (page 66)
EV Shift	Adjusts the EV shift value (page 39)
White Balance	Changes the white balance setting (page 65)
ISO	Changes the ISO Sensitivity setting (page 37)
Self-timer	Sets the self-timer time (page 59)
Off	Cancels [◀] and [▶] key assignments

Displaying the On-screen Grid (Grid)

Procedure

[] (REC) → [MENU] → REC Tab → Grid

The on-screen grid can be displayed on the REC mode monitor screen for easy vertical and horizontal alignment when composing images.

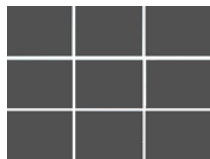

Turning Digital Zoom On or Off (Digital Zoom)

Procedure

[CAMERA] (REC) → [MENU] → REC Tab → Digital Zoom

You can use this setting to turn digital zoom on or off. When digital zoom is turned off, operating the zoom controller zooms the image with optical zoom only.

Turning on Image Review (Review)

Procedure

[CAMERA] (REC) → [MENU] → REC Tab → Review

While Review is turned on, the camera will display a image for about one second immediately after you press the shutter button to record it.

Using Icon Help (Icon Help)

Procedure

[CAMERA] (REC) → [MENU] → REC Tab → Icon Help

While Icon Help is turned on, a textual description will appear on the display for certain icons when you switch between REC functions.

Functions Supported by Icon Help

- REC Mode, Flash, Metering Mode, White Balance, Self-timer, EV Shift

Configuring Power On Default Settings (Memory)

Procedure

[] (REC) → [MENU] → REC Tab → Memory

When you turn off the camera, it remembers the current settings of all enabled memory items and restores them when you turn it back on. Any memory item that is disabled will be returned to its initial default setting whenever you turn off the camera.

Setting	Disabled (Initial Default Setting)	Enabled
 BEST SHOT	Snapshot (Auto)	Setting at power off
Flash	Auto	
Focus	AF (Auto Focus)	
White Balance	Auto	
ISO	Auto	
AF Area	Spot	
Metering	Multi	
CS	Off	
Self-timer	Off	
Flash Intensity	0	
Digital Zoom	On	
MF Position	Position before manual focus was selected.	
Zoom Position*	Full wide	

* Optical zoom setting only.

- If you turn the camera power off and then back on while the BEST SHOT memory item is enabled, all of the other memory items (except for zoom position) are initialized to the currently selected BEST SHOT sample scene setup, regardless of the enabled/disabled status of the other memory items.

Image Quality Settings (Quality)

Specifying Snapshot Size (Size)



Procedure

[] (REC) → [MENU] → Quality Tab → Size

For details, see the Control Panel procedure on page 32.

Specifying Snapshot Image Quality (Quality (Snapshot))

Procedure



[] (REC) → [MENU] → Quality Tab →  Quality

Fine	Gives image quality priority
Normal	Normal
Economy	Gives number of images priority

- The “Fine” setting helps to bring out details when shooting a finely detailed image of nature that includes dense tree branches or leaves, or an image of a complex pattern.
- Memory capacity (the number of images you can record) will be affected by the quality settings you configure (page 136).

Specifying Movie Image Quality (Quality (Movie))

Procedure

[] (REC) → [MENU] → Quality Tab →  Quality

Movie image quality is a standard that determines the detail, smoothness, and clarity of a movie during playback. Shooting with the high-quality (WIDE) setting will result in better image quality, but it also shortens the amount of time you can shoot.

Image Quality (Pixels)		Approximate Data Rate	Frame Rate
WIDE	848×480	12.5 Megabits/second	30 frames/second
STD	640×480	10.6 Megabits/second	
LP	320×240	2.7 Megabits/second	15 frames/second

- Memory capacity (Movie recording time you can shoot) will be affected by the quality settings you configure (page 137).

Correcting Image Brightness (EV Shift)

Procedure

[] (REC) → [MENU] → Quality Tab → EV Shift

For details, see the Control Panel procedure on page 39.

Controlling White Balance (White Balance)

Procedure

[] (REC) → [MENU] → Quality Tab → White Balance

For details, see the Control Panel procedure on page 37.

Specifying ISO Sensitivity (ISO)

Procedure

[] (REC) → [MENU] → Quality Tab → ISO

For details, see the Control Panel procedure on page 37.

Specifying the Metering Mode (Metering)

Procedure

[] (REC) → [MENU] → Quality Tab → Metering

The metering mode determines what part of the subject is metered for exposure.

Multi	Multi-pattern metering divides the image into sections and measures the light in each section for a balanced exposure reading. This type of metering provides error-free exposure settings for a wide range of shooting conditions.
Center Weighted	Center weighted metering concentrates on the center of the focus area to measure light. This type of metering is best when you want some level of control over contrast.
Spot	Spot metering takes readings at a very small area. Use this metering method when you want exposure to be set according to the brightness of a particular subject, without being affected by surrounding conditions.

- The currently selected metering mode is indicated by an icon on the snapshot screen. No icon is displayed when “ Multi” is selected as the metering mode.

Using Built-in Color Filters (Color Filter)

Procedure

[] (REC) → [MENU] → Quality Tab → Color Filter

Settings: Off, B/W, Sepia, Red, Green, Blue, Yellow, Pink, and Purple

Controlling Image Sharpness (Sharpness)

Procedure

[CAMERA] (REC) → [MENU] → Quality Tab → Sharpness

You can specify one of five sharpness settings from +2 (sharpest) to -2 (least sharp).

Controlling Color Saturation (Saturation)

Procedure

[CAMERA] (REC) → [MENU] → Quality Tab → Saturation

You can specify one of five saturation settings from +2 (most saturated) to -2 (least saturated).

Adjusting Image Contrast (Contrast)

Procedure

[CAMERA] (REC) → [MENU] → Quality Tab → Contrast

You can specify one of five contrast settings from +2 (most contrast between light and dark) to -2 (least contrast between light and dark).

Specifying Flash Intensity (Flash Intensity)

Procedure

[CAMERA] (REC) → [MENU] → Quality Tab → Flash Intensity

You can specify one of five flash intensity settings from +2 (strongest) to -2 (weakest).

- Flash intensity may not change when the subject is too far away or too close.

Viewing Snapshots and Movies

Viewing Snapshots

See page 26 for the procedure for viewing snapshots.

Viewing a Movie

1. Press [▶] (PLAY) and then use [◀] and [▶] to display the movie you want to view.
2. Press [SET] to start playback.



Movie Playback Controls

Fast forward/ fast reverse	[◀] [▶] <ul style="list-style-type: none">• Each press of either button increases the speed of the fast forward or fast reverse operation.• To return to normal playback speed, press [SET].
Play/pause	[SET]
1 frame forward/ back	[◀] [▶] <ul style="list-style-type: none">• Holding down either button scrolls continuously.
Volume adjustment	Press [▼] and then press [▲] [▼] <ul style="list-style-type: none">• Volume can be adjusted only while movie playback is in progress.
Information display on/off	[▲] (DISP)
Zoom	Slide the zoom controller in the direction of [Q] (Q). <ul style="list-style-type: none">• You can use [▲], [▼], [◀], and [▶] to scroll the zoomed image on the monitor screen. You can zoom a movie image up to 4.5 times normal size.
Stop playback	[MENU]

- Playback may not be possible for movies not recorded with this camera.

Zooming an On-screen Image

1. In the PLAY mode, use [◀] and [▶] to scroll through the images until the one you want is displayed.
2. Slide the zoom controller towards [🔍] (🔍) to zoom.

You can use [▲], [▼], [◀], and [▶] to scroll the zoomed image on the monitor screen. Slide the zoom controller towards [🔍] to unzoom the image.

- If display indicators are turned on, an indicator in the lower right corner of the monitor screen shows what part of the zoomed image is currently displayed.
- To exit the zoom screen, press [MENU] or [BS].
- Though the maximum image zoom factor is 8X, certain image sizes may not allow zooming up to the full 8X.

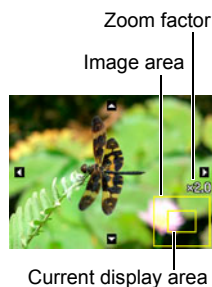

Displaying the Image Menu

1. In the PLAY mode, slide the zoom controller towards [🔍] (🔍).

Use [▲], [▼], [◀] and [▶] to move the selection boundary around the image menu.

To view a particular image, use [▲], [▼], [◀], or [▶] to move the selection boundary to the image you want and then press [SET].



Viewing Snapshots and Movies on a TV Screen

1. Use an optionally available AV cable (EMC-4A) to connect it to the TV.

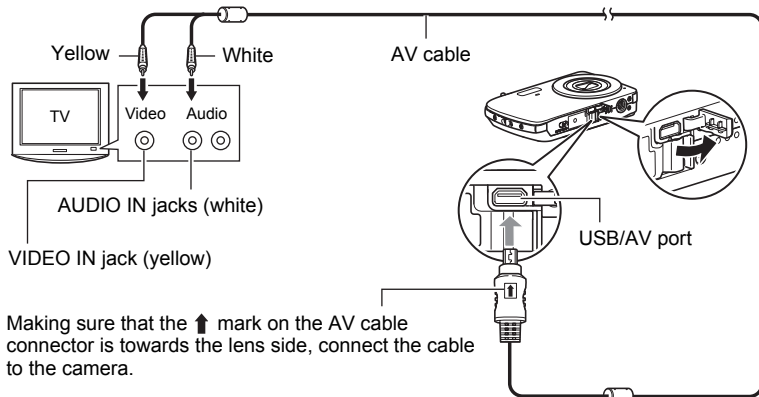

- Make sure that you insert the cable connector into the USB/AV port until you feel it click securely into place. Failure to insert the connector fully can result in poor communication or malfunction.
- Note that even while the connector is fully inserted, you still will be able to see the metal part of the connector as shown in the illustration.



2. Turn on the TV and select its video input mode.

If the TV has more than one video input, select the one where the camera is connected.

3. Press [▶] (PLAY) to turn on the camera.

This will cause an image to appear on the TV screen, without anything appearing on the camera's monitor screen.

- Pressing [ON/OFF] or [📷] (REC) will not turn on the camera while the AV cable is connected.
- You also can change the aspect ratio of the screen and the video output system (page 111).

4. Now you can display images and play back movies as you normally do.



IMPORTANT!

- Before connecting to a TV to display images, be sure to configure the camera's [RECORD] (REC) and [PLAY] (PLAY) buttons for "Power On" or "Power On/Off" (page 110).
- Audio is initially output by the camera at maximum volume. When you first start displaying images, set the TV volume control at a relatively low level and then adjust it as required.

NOTE

- Audio is monaural.
- Certain TVs may cut off part of the images.
- All icons and indicators that appear on the monitor screen also appear on the TV screen. You can use [DISP] (DISP) to change the display contents.

Recording Camera Images to a DVD Recorder or Video Deck

Use one of the following methods to connect the camera to the recording device using an optionally available AV cable.

- DVD recorder or video deck: Connect to the VIDEO IN and AUDIO IN terminals.
- Camera: USB/AV port

You can play a slideshow of snapshots and movies on the camera and record it on a DVD or video tape. When recording images to an external device, use [DISP] (DISP) to clear all indicators from the monitor screen (page 113).

For information about connecting a monitor to the recording device and about how to record, see the user documentation that comes with the recording device you are using.

Other Playback Functions (PLAY)

This section explains menu items that you can use to configure settings and perform other playback operations.

For information about menu operations, see page 52.

Playing a Slideshow on the Camera (Slideshow)

Procedure

[▶] (PLAY) → [MENU] → PLAY Tab → Slideshow

Start	Starts the slideshow
Time	Time from the start to the end of the slideshow 1 to 5 minutes, 10 minutes, 15 minutes, 30 minutes, 60 minutes
Interval	Amount of time each image remains displayed Use [◀] and [▶] to select a value from 1 to 30 seconds, or "MAX". If you specify a value from 1 to 30 seconds, images change at the specified interval, but the audio portion of movies and audio snapshots will continue to play until the end. When the slideshow reaches a movie file while "MAX" is selected, only the first frame of the movie will be displayed. Voice Recording files are not played back when "MAX" is selected.
Effect	Turns effect on or off. On: Turns on the image change effect and background music. Off: No image change effect or background music

- To stop the slideshow, press [SET]. Pressing [MENU] instead of [SET] stops the slideshow and returns to the menu screen.
- Adjust audio volume by pressing [▼] and then press [▲] or [▼] during playback.
- All button operations are disabled while the slideshow is transitioning from one image to another.
- The time required for transition from one image to another may be longer in the case of an image that was not recorded with this camera.

Selecting Images for Printing (DPOF Printing)

Procedure



[▶] (PLAY) → Snapshot Screen → [MENU] → PLAY Tab → DPOF Printing

See page 81 for details.

Protecting a File Against Deletion (Protect)

Procedure

[▶] (PLAY) → [MENU] → PLAY Tab → Protect

On	<p>Protects specific files.</p> <ol style="list-style-type: none">① Use [◀] and [▶] to scroll through the files until the one you want to protect is displayed.② Use [▲] and [▼] to select “On” and then press [SET]. An image that is protected is indicated by the  icon.③ To protect other files, repeat steps 1 and 2. <p>To exit the protect operation, press [MENU]. To unprotect a file, select “Off” instead of “On” in step 2 above.</p>	
All Files: On	<p>Protects all files.</p> <ol style="list-style-type: none">① Use [▲] and [▼] to select “All Files: On” and then press [SET].② Press [MENU]. <p>To unprotect all files, select “All Files: Off” instead of “All Files: On” in step 1 above.</p>	

IMPORTANT!

- Note that even if a file is protected, it will be deleted if you perform the format operation (page 112).

Rotating an Image (Rotation)

Procedure

[] (PLAY) → Snapshot Screen → [MENU] → PLAY Tab → Rotation

1. Use [] and [] to select “Rotation” and then press [SET].

Each press of [SET] will rotate the displayed image 90 degrees left.

2. When the displayed image is at the orientation you want, press [MENU].

NOTE

- Note that this procedure does not actually change the image data. It simply alters how the image is displayed on the camera's monitor screen.
- An image that has been protected or zoomed and movie screen cannot be rotated.
- The original (unrotated) version of the image will be displayed on the 12-image screen.

Resizing a Snapshot (Resize)

Procedure

[] (PLAY) → Snapshot Screen → [MENU] → PLAY Tab → Resize

You can reduce the size of a snapshot and save the result as a separate snapshot. The original snapshot is also retained. You can select resize an image to one of three image sizes: 7M, 4M, VGA.

- Resizing a 3:2 or 16:9 size snapshot will create an image with an aspect ratio of 4:3, with both sides cut off.
- The recording date of the resized version of the snapshot will be the same as the recording date of the original snapshot.

Cropping a Snapshot (Trimming)

Procedure

[▶] (PLAY) → Snapshot Screen → [MENU] → PLAY Tab → Trimming

You can crop a snapshot to trim parts you do not need, and save the result in a separate file. The original snapshot is also retained.

Use the zoom controller to zoom the image to the size you want, use [▲], [▼], [◀], and [▶] to display the portion of the image you want to cut out, and then press [SET].

- The image produced by cropping a 3:2 or 16:9 image will have an aspect ratio of 4:3.
- The recording date of the cropped image will be the same as the recording date of the original snapshot.

Zoom factor
Represents
snapshot area



Part of snapshot that is currently displayed

Adding Audio to a Snapshot (Dubbing)

Procedure

[▶] (PLAY) → Snapshot Screen → [MENU] → PLAY Tab → Dubbing

You can add audio to a snapshot after you shoot it. You can re-record a snapshot's audio whenever you want. You can record up to about 30 seconds of audio for a single snapshot.

1. Press the shutter button to start audio recording.



Remaining recording time

2. Press the shutter button again to stop audio recording.

- Take care that you do not block the camera's microphone with your fingers while recording.
- Good recording results are not possible when the camera is too far away from what you are trying to record.
- Your camera supports the following audio data formats.
 - Audio Format: WAVE/IMA-ADPCM (WAV extension)
- Adding audio (dubbing) is not possible for the following types of images.
 - Protected images
- To delete audio, perform the following operation:
Dubbing → Delete → [SET] → [MENU].

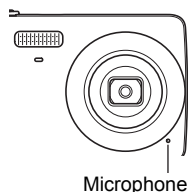

IMPORTANT!

- Note that you cannot restore the original audio of an Audio Snapshot after you delete or re-record it.

To play snapshot audio

1. In the PLAY mode, use [◀] and [▶] to scroll through the images until the Audio Snapshot you want is displayed.

An audio snapshot is one that has a  icon.

2. Press [SET] to start playback.

Voice Recording Playback Controls

Fast forward/fast reverse	[◀] [▶]
Play/pause	[SET]
Volume adjustment	Press [▼] and then press [▲] [▼]
Display content switching	[▲] (DISP)
Stop playback	[MENU]







- Audio of an Audio Snapshot also can be played back on a computer using Windows Media Player or QuickTime (pages 89, 98).

Copying Files (Copy)

Procedure

[] (PLAY) → Snapshot Screen → [MENU] → PLAY Tab → Copy

Files can be copied from the camera's built-in memory to a memory card or from a memory card to built-in memory.

Built-in → Card	Copies all files from built-in camera memory to a memory card. This option copies all the files in built-in camera memory. It cannot be used to copy a single file.
Card → Built-in	Copies a single file on the memory card to camera built-in camera memory. Files are copied to the folder in built-in memory whose name has the largest serial number. ① Use [] and [] to select the file you want to copy. ② Use [] and [] to select "Copy" and then press [SET].

NOTE

- You can copy snapshots, movies, audio snapshots, or Voice Recording files you recorded with this camera.

Printing Snapshots

Professional Print Service

You can take a memory card that contains the images you want to print to a professional print service and have them printed.



Printing on a Home Printer

Printing Images on a Printer with Memory Card Slot

You can use a printer equipped with a memory card slot to print images directly from a memory card. For details, see the user documentation that comes with your printer.



Connecting Directly to a PictBridge Compatible Printer

You can print on a printer that supports PictBridge (page 79).



Printing with a Computer

After transferring the images to your computer, use commercially available software to print.

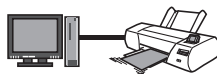

- You can specify which images you want to print, the number of copies, and date stamp settings before printing (page 81).

Connecting Directly to a PictBridge Compatible Printer

You can connect the camera directly to a printer that supports PictBridge and print images without going through a computer.

■ To set up the camera before connecting to a printer

1. Turn on the camera and press [MENU].

2. On the “Set Up” tab, select “USB” and then press [▶].

3. Use [▲] and [▼] to select “PTP (PictBridge)”, and then press [SET].

■ Connecting the Camera to a Printer

Use the USB cable that comes bundled with the camera to connect the camera to your printer’s USB port.

- The camera does not draw power over the USB cable. Make sure the camera’s battery is sufficiently charged before connecting.
- Make sure that you insert the cable connector into the USB/AV port until you feel it click securely into place. Failure to insert the cable fully can result in poor communication or malfunction.
- Note that even while the connector is fully inserted, you still will be able to see the metal part of the connector as shown in the illustration.
- When connecting the USB cable to a USB port, make sure you align the connector correctly with the port.

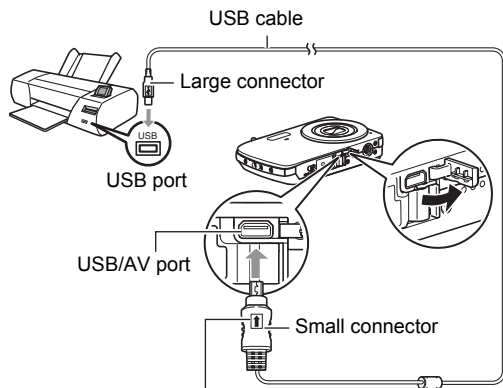

Making sure that the ↑ mark on the USB cable connector is towards the lens side, connect the cable to the camera.



■ To print

1. Turn on the printer and load paper.

2. Turn on the camera.

This will display the print menu screen.

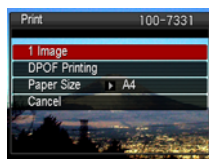

3. Use [▲] and [▼] to select “Paper Size”, and then press [▶].

4. Use [▲] and [▼] to select a paper size and then press [SET].

- The following are the available paper sizes.
3.5"×5", 5"×7", 4"×6", A4, 8.5"×11", By Printer
- Selecting “By Printer” prints using a paper size selected on the printer.
- See the documentation that comes with your printer for information about paper settings.

5. Use [▲] and [▼] to specify the print option you want.

1 Image : Prints one image. Select and then press [SET]. Next, use [◀] and [▶] to select the image you want to print.

DPOF Printing: Prints multiple images. Select and then press [SET]. With this option, images will be printed in accordance with DPOF settings (page 81).

- To toggle date stamping on and off, press [BS]. The date stamp will be printed when “On” is indicated on the monitor screen.

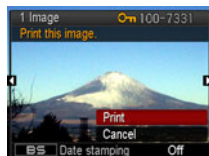

6. Use [▲] and [▼] to select “Print” and then press [SET].

Printing will start and the message “Busy... Please wait...” will appear on the monitor screen. The message will disappear after a short while, even though printing is still being performed. Pressing any camera button will cause the printing status to re-appear. The print menu screen will re-appear when printing is complete.

- If you selected “1 Image”, you can repeat the procedure from step 5, if you want.

7. After printing is complete, turn off the camera and disconnect the USB cable from the printer and camera.

Using DPOF to Specify Images to be Printed and the Number of Copies

■ Digital Print Order Format (DPOF)

DPOF is a standard that allows you to include image type, number of copy, and time stamp on/off information on the memory card with the images. After configuring settings, you can use the memory card to print on a home printer that supports DPOF or take the memory card to a professional print service.



- Whether or not you will be able to use DPOF settings for printing depends on the printer you are using.
- Some professional print services may not support DPOF.

■ Configuring DPOF Settings Individually for Each Image

Procedure

[] (PLAY) → Snapshot Screen → [MENU] → PLAY Tab → DPOF Printing → Select images

1. Use [] and [] to scroll through the files until the image you want to print is displayed.

2. Use [] and [] to specify the number of copies.
You can specify a value up to 99. Specify 00 if you do not want to print the image.
 - If you want to include the date in the images, press [BS] so “On” is shown for date stamping.
 - Repeat steps 1 and 2 to configure settings for other images, if you want.

3. Press [SET].

■ Configuring the Same DPOF Settings for All the Images

Procedure

[] (PLAY) → Snapshot Screen → [MENU] → PLAY Tab → DPOF Printing → All images

1. Use [] and [] to specify the number of copies.

You can specify a value up to 99. Specify 00 if you do not want to print the image.

- If you want to include the date in the images, press [BS] so “On” is shown for date stamping.

2. Press [SET].

DPOF settings are not cleared automatically after printing is complete.

The next DPOF print operation you execute will be performed using the last DPOF settings you configured for the images. To clear DPOF settings, specify “00” for the number of copies of all images.

Tell your print service about your DPOF settings!

If you take a memory card to a professional print service, be sure to tell them that it includes DPOF settings for the images to be printed and the number of copies. If you don't, the print service may print all the images without regard to your DPOF settings, or they may ignore your date stamp setting.

■ Date Stamping

You can use one of the following three methods to include the recording date in the printout of an image.

Configuring camera settings
Configure DPOF settings (page 81). You can turn date stamping on and off each time you print. You can configure settings so some images include the date stamp and some don't.
Configure the Camera's Time Stamp setting (page 107). <ul style="list-style-type: none">• The camera's Time Stamp setting imprints the date into a snapshot when you shoot it, so the date is always included when you print. It cannot be deleted.• Do not turn on DPOF date stamping for an image that includes a date stamped with the camera's Time Stamp function. Doing so can cause the two stamps to be overprinted.
Configuring computer settings
You can use commercially available image management software to date stamp images.
Professional print service
Request date stamping when ordering prints from a professional print service.

■ Standards Supported by the Camera

- PictBridge

This is a standard of the Camera and Imaging Products Association (CIPA). You can connect the camera directly to a printer that supports PictBridge, and perform image selection and printing using the camera monitor screen and controls.



- Exif Print



Printing on a printer that supports Exif Print (Exif 2.2) uses information about shooting conditions recorded with the image to enhance printed image quality. Contact your printer manufacturer for information about models that support Exif Print, printer upgrades, etc.



Using the Camera with a Computer

Things you can do using a computer...

You can perform the operations described below while the camera is connected to a computer.

Save images to a computer and view them there		<ul style="list-style-type: none">• Save images and view them manually (USB connection) (pages 86, 95).• Transfer images to a computer automatically over a wireless LAN for viewing (Eye-Fi) (page 99).
Transfer images stored on your computer to camera memory		In addition to images, you also can transfer screen shot images from your computer to the camera (Photo Transport*) (page 92).
Playback and edit movies		<ul style="list-style-type: none">• You can play back movies (pages 89, 98).• To edit movies, use commercially available software as required.

* Windows only

The procedures you need to perform when using the camera with your computer and when using the bundled software are different for Windows and the Macintosh.

- Windows users should refer to “Using the Camera with a Windows Computer” on page 85.
- Macintosh users should refer to “Using the Camera with a Macintosh” on page 95.

Using the Camera with a Windows Computer

Install the required software in accordance with the version of Windows you are running and what you want to do.

When you want to do this:	Operating System Version	Install this software:	See page:
Save images to a computer and view them there manually	Vista / XP / 2000	Installation not required.	86
Play movies	Vista / XP / 2000	Installation not required. <ul style="list-style-type: none">• Windows Media Player, which is already installed on most computers, can be used for playback.• If your computer is running Windows 2000 and does not have DirectX9.0c or higher installed, download DirectX from the Microsoft DirectX site and install it on your computer.	89
Edit movies	Vista / XP / 2000	– <ul style="list-style-type: none">• Use commercial software as required.	–
Upload movie files to YouTube	Vista / XP (SP2/SP3) / 2000 (SP4)	YouTube Uploader for CASIO*	90
Transfer images to the camera	Vista / XP / 2000	Photo Transport 1.0*	92
View the User's Guide	Vista / XP (SP2/SP3) / 2000 (SP4)	Adobe Reader 8 (Not required if already installed.)	94

* YouTube Uploader for CASIO and Photo Transport will not run under 64-bit versions of Windows Vista.

■ Computer System Requirements for Bundled Software

Computer system requirements are different for each of the applications. See the “Read me” file that comes with each application for details. Information about computer system requirements also can be found under “Computer System Requirements for Bundled Software” on page 126 of this manual.

■ Precautions for Windows Users

- Except for Adobe Reader, the bundled software requires Administrator privileges to run.
- Operation on a self-made computer is not supported.
- Operation may not be possible under certain computer environments.

Viewing and Storing Images on a Computer

You can connect the camera to your computer in order to view and store images (snapshot and movie files).

■ To connect the camera to your computer and save files

1. Turn on the camera and press [MENU].

2. On the “Set Up” tab, select “USB” and then press [▶].

3. Use [▲] and [▼] to select “Mass Storage”, and then press [SET].

4. Turn off the camera and then use the USB cable that comes with the camera to connect it to your computer.

- The camera does not draw power over the USB cable. Make sure the camera's battery is sufficiently charged before connecting.
- Make sure that you insert the cable connector into the USB/AV port until you feel it click securely into place. Failure to insert the connector fully can result in poor communication or malfunction.
- Note that even while the connector is fully inserted, you still will be able to see the metal part of the connector as shown in the illustration.
- When connecting the USB cable to a USB port, make sure you align the connector correctly with the port.
- Your computer may not be able to recognize the camera if you connect via a USB hub. Always connect directly to the computer's USB port.

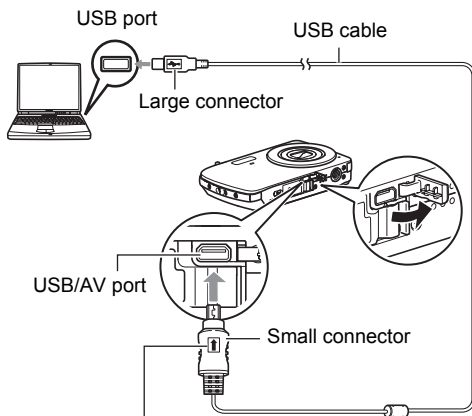

Making sure that the ↑ mark on the USB cable connector is towards the lens side, connect the cable to the camera.



5. Turn on the camera.

-
- 6. Windows Vista users: Click “Start” and then “Computer”.
Windows XP users: Click “Start” and then “My Computer”.
Windows 2000 users: Doubleclick “My Computer”.**

7. Double-click “Removable Disk”.

- Your computer recognizes the memory card loaded in the camera (or built-in memory if there is no card) as a removable disk.

8. Right-click the “DCIM” folder.

9. On the shortcut menu that appears, click “Copy”.

10. Windows Vista users: Click “Start” and then “Documents”.

Windows XP users: Click “Start” and then “My Documents”.

Windows 2000 users: Doubleclick “My Documents” to open it.

- If you already have a “DCIM” folder in “My Documents”, the next step will overwrite it. If you want to keep the existing “DCIM” folder, you need to change its name or move it to a different location before performing the next step.

11. On the “My Documents” “Edit” menu, select “Paste”.

This will paste the “DCIM” folder (and all the image files it contains) into your “My Documents” folder. You now have a copy of the files that are in camera memory on your computer.

12. After you finish copying images, disconnect the camera from the computer.

Windows Vista, Windows XP

On the camera, press [ON/OFF] to turn off the camera. After making sure that the back lamp is unlit, disconnect the camera from the computer.

Windows 2000

Click card services in the task tray on your computer screen, and disable the drive number assigned to the camera. Next, after making sure that the back lamp is unlit, press the camera’s [ON/OFF] button to turn off the camera and disconnect the camera from your computer.

■ To view images you copied to your computer

1. Double-click the copied “DCIM” folder to open it.

2. Double-click the folder that contains the images you want to view.

3. Double-click the image file you want to view.

- For information about file names, see “Memory Folder Structure” on page 102.
- An image that was rotated on the camera will be displayed on your computer screen in its original (unrotated) orientation.

Never use your computer to modify, delete, move, or rename any image files that are in the camera’s built-in memory or on its memory card.

Doing so can cause problems with the camera’s image management data, which will make it impossible to play back images on the camera and can drastically alter remaining memory capacity. Whenever you want to modify, delete, move, or rename an image, do so only on images that are stored on your computer.

IMPORTANT!

- Never unplug the USB cable, or operate the camera while viewing or storing images. Doing so can cause data to become corrupted.

Playing Movies

Windows Media Player, which is already installed on most computers, can be used for movie playback. To play back a movie, first copy the movie to your computer and then double-click the movie file.

■ Minimum Computer System Requirements for Movie Playback

The minimum system requirements described below are necessary to play back movies recorded with this camera on a computer.

Operating System : Vista / XP / 2000

CPU : Image Quality “WIDE”:
Pentium 4 3.2 GHz or higher
Image Quality “STD” or “LP”:
Pentium M 1.0 GHz or higher
Pentium 4 2.0 GHz or higher

Required Software: Windows Media Player, DirectX 9.0c or higher

- The above are recommended system environments. Configuring one of these environments does not guarantee proper operation.
- Certain settings and other installed software may interfere with proper playback of movies.

■ **Movie Playback Precautions**

- Be sure to move the movie data to the hard disk of your computer before trying to play it. Proper movie playback may not be possible for data accessed over a network, from a memory card, etc.
- Proper movie playback may not be possible on some computers. If you experience problems, try the following.
 - Try recording movies with a quality setting of “LP”.
 - Try upgrading Windows Media Player to the latest version.
 - Quit any other applications you have running, and stop resident applications.

Even if proper playback is not possible on the computer, you can use an optionally available AV cable (EMC-4A) to connect to the video input terminal a TV or computer and play back movies that way.

■ **Uploading Movie Files to YouTube**

Installing YouTube Uploader for CASIO from the CD-ROM that comes with your camera simplifies uploading of movie files you recorded with the “For YouTube” BEST SHOT scene to YouTube.

■ **What is YouTube?**

YouTube is a movie sharing site managed by YouTube, LLC where you can upload movies and view movies uploaded by others.

■ **To install YouTube Uploader for CASIO**

- 1. On the CD-ROM menu screen, select “YouTube Uploader for CASIO”.**

- 2. After reading the information about installation conditions and system requirements for installation in the “Read me” file, install YouTube Uploader for CASIO.**

■ To upload a movie file to YouTube

- Before you can use YouTube Uploader for CASIO, you need to go to the YouTube website (<http://www.youtube.com/>) and register as a user there.
- Do not upload any video that is copyrighted (including neighboring copyrights) unless you yourself own the copyright or you have obtained the permission of the applicable copyright holder(s).
- The maximum file size for each upload is 1024MB.

1. Record the movie you want to upload using the “For YouTube” BEST SHOT movie scene.

2. If it isn't already, connect your computer to the Internet.

3. Connect the camera to your computer (page 86).

4. Turn on the camera.

YouTube Uploader for CASIO will start up automatically.

- If this is the first time you are using the application, configure the YouTube user ID and network environment settings, and then click the [OK] button.
-

5. The left side of the display will have an area for inputting a title, category, and other information required for uploading to YouTube. Enter the required information.

6. The right side of the display shows a list of movie files in camera memory. Select the check box next to the movie file you want to upload.

7. When everything is ready, click the [Upload] button.

This will upload the movie file(s) to YouTube.

- After uploading is complete, click the [Exit] button to exit the application.

Transferring Images from Your Computer to Camera Memory

If you want to transfer images from your computer to the camera, install Photo Transport on your computer from the CD-ROM that comes with the camera.

■ To install Photo Transport

1. On the CD-ROM menu screen, select “Photo Transport”.

2. After reading the information about installation conditions and system requirements for installation in the “Read me” file, install Photo Transport.

■ To transfer images to the camera

1. Connect the camera to your computer (page 86).

2. On your computer, click the following: Start → All Programs → CASIO → Photo Transport.
This starts up Photo Transport.

3. Drag the file(s) you want to transfer to the [Transfer] button.

4. Follow the instructions that appear on the display to complete the transfer.
 - The details of the instructions that appear on the display and the transferred images will depend on your Photo Transport setup. For details, click the [Settings] button or [Help] button and check the setup.

Transfer Data

- Only image files with the following extensions can be transferred to the camera: jpg, jpeg, jpe, bmp (bmp images are converted to jpeg image automatically when transferred.)
- Certain types of images may not be able to be transferred.
- You cannot transfer movies to the camera.

■ To transfer computer screen captures to the camera

1. Connect the camera to your computer (page 86).

2. On your computer, click the following: Start → All Programs → CASIO → Photo Transport.

This starts up Photo Transport.

3. Display the screen whose screen capture you want to transfer.

4. Click the [Capture] button.

5. Draw a boundary around the area you want to capture.

Move your mouse pointer to the upper left corner of the area you want to capture and then hold down the mouse button. Keeping the mouse button depressed, drag the pointer down to the lower right corner of the area and then release the mouse button.

6. Follow the instructions that appear on the display.

This will send an image of the area you selected to the camera.

- The transfer operation converts screen captures to JPEG format.
- The instructions that appear on the display and details about the transferred images will depend on your Photo Transport setup. For details, click the [Settings] button or [Help] button and check the setup.

■ About settings and help

Click the [Settings] button when you want to change the Photo Transport setup. For help about operation procedures and troubleshooting, click the Photo Transport [Help] button.

Viewing User Documentation (PDF Files)

- 1. Start up your computer, and place the bundled CD-ROM into its CD-ROM drive.**

Normally, this should cause the menu screen to appear automatically. If your computer does not display the menu screen automatically, navigate to the CD-ROM on your computer and then double-click the "AutoMenu.exe" file.

- 2. On the menu screen, click the "Language" down arrow button and then select the language you want.**
-

- 3. Click "Manual" to select it and then click "Digital Camera".**

IMPORTANT!

- You must have Adobe Reader or Adobe Acrobat Reader installed on your computer in order to view the contents of a PDF file. If you do not already have Adobe Reader or Adobe Acrobat Reader installed, install Adobe Reader from the bundled CD-ROM.

User Registration

You can perform user registration over the Internet. To do so, of course, you need to be able to connect to the Internet with your computer.

- 1. On the CD-ROM menu screen, click the "Register" button.**
 - This starts up your Web browser and accesses the user registration website. Follow the instructions that appear on your computer screen to register.

Using the Camera with a Macintosh

Install the required software in accordance with what version of the Macintosh OS you are running and what you want to do.

When you want to do this:	Operating System Version	Install this software:	See page:
Save images to your Macintosh and view them there manually	OS 9	Installation not required.	95
	OS X		
Save images to your Macintosh automatically/ Manage images	OS 9	Use commercially available software.	98
	OS X	Use iPhoto, which comes bundled with some Macintosh products.	
Play movies	OS 9 / OS X	You can playback with QuickTime, which comes bundled with your operating system.	98

Connecting the Camera to Your Computer and Saving Files



IMPORTANT!

- The camera does not support operation with Mac OS 8.6 or earlier, or Mac OS X 10.0. Operation is supported with Mac OS 9, X (10.1, 10.2, 10.3, 10.4, 10.5) only. Use the standard USB driver that comes with your supported operating system.

■ To connect the camera to your computer and save files

1. Turn on the camera and press [MENU].
2. On the “Set Up” tab, select “USB” and then press [▶].
3. Use [▲] and [▼] to select “Mass Storage”, and then press [SET].

4. Turn off the camera and then use the USB cable that comes with the camera to connect it to your Macintosh.

- The camera does not draw power over the USB cable. Make sure the camera's battery is sufficiently charged before connecting.
- Make sure that you insert the cable connector into the USB/AV port until you feel it click securely into place. Failure to insert the connector fully can result in poor communication or malfunction.
- Note that even while the connector is fully inserted, you still will be able to see the metal part of the connector as shown in the illustration.
- When connecting the USB cable to a USB port, make sure you align the connector correctly with the port.
- Your computer may not be able to recognize the camera if you connect via a USB hub. Always connect directly to the computer's USB port.

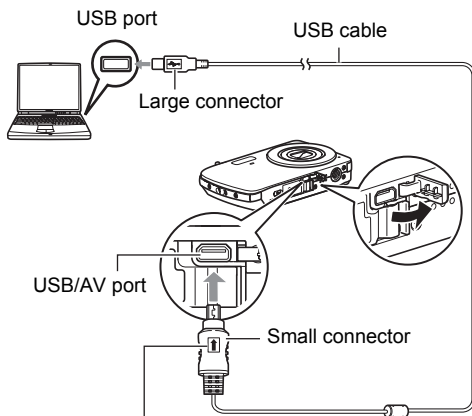

Making sure that the ↑ mark on the USB cable connector is towards the lens side, connect the cable to the camera.



5. Turn on the camera.

The camera's back lamp will light green at this time. In this mode, your Macintosh recognizes the memory card loaded in the camera (or the camera's built-in memory if it does not have a memory card loaded) as a drive. The appearance of the drive icon depends on the Mac OS version you are using.

6. Double-click the camera's drive icon.

-
7. Drag the “DCIM” folder to the folder to which you want to copy it.
 8. After the copy operation is complete, drag the drive icon to Trash.
 9. On the camera, press [ON/OFF] to turn off the camera. After making sure that the green back lamp is unlit, disconnect the camera from the computer.
-

■ **To view copied images**

1. Double-click the camera’s drive icon.
 2. Double-click the “DCIM” folder to open it.
 3. Double-click the folder that contains the images you want to view.
 4. Double-click the image file you want to view.
 - For information about file names, see “Memory Folder Structure” on page 102.
 - An image that was rotated on the camera will be displayed on your Macintosh screen in its original (unrotated) orientation.
-

Never use your computer to modify, delete, move, or rename any image files that are in the camera’s built-in memory or on its memory card.

Doing so can cause problems with the camera’s image management data, which will make it impossible to play back images on the camera and can drastically alter remaining memory capacity. Whenever you want to modify, delete, move, or rename an image, do so only on images that are stored on your computer.

 **IMPORTANT!**

- Never unplug the USB cable, or operate the camera while viewing or storing images. Doing so can cause data to become corrupted.

Transferring Images Automatically and Managing Them on Your Macintosh

If you are running Mac OS X, you can manage snapshots using iPhoto, which comes bundled with some Macintosh products. If you are running Mac OS 9, you will need to use commercially available software.

Playing a Movie

You can use QuickTime, which comes bundled with your operating system, to play back movies on a Macintosh. To play back a movie, first copy it to your Macintosh and then double-click the movie file.

■ Minimum Computer System Requirements for Movie Playback

The minimum system requirements described below are necessary to play back movies recorded with this camera on a computer.

Operating System : Mac OS X 10.3.9 or higher

Required Software: QuickTime 7 or higher

- The above are recommended system environments. Configuring one of these environments does not guarantee proper operation.
- Certain settings and other installed software may interfere with proper playback of movies.

■ Movie Playback Precautions

Proper movie playback may not be possible on some Macintosh models. If you experience problems, try the following.

- Change the movie image quality setting to “LP”.
- Upgrade to the latest version of QuickTime.
- Shut down other applications that are running.

Even if proper playback is not possible on your Macintosh, you can use an optionally available AV cable (EMC-4A) to connect to the video input terminal a TV or Macintosh and play back movies that way.

IMPORTANT!

- Be sure to move the movie data to the hard disk of your Macintosh before trying to play it. Proper movie playback may not be possible for data accessed over a network, from a memory card, etc.

Viewing User Documentation (PDF Files)

You must have Adobe Reader or Adobe Acrobat Reader installed on your computer in order to view the contents of a PDF file. If you don't, go to the Adobe Systems Incorporated website and install Acrobat Reader.

1. On the CD-ROM, open the "Manual" folder.
2. Open the "Digital Camera" folder and then open the folder for the language whose user's guide you want to view.
3. Open the file named "camera_xx.pdf".
 - "xx" is the language code (Example: camera_e.pdf is for English.)

User Registration

Internet registration only is supported. Visit the following CASIO website to register:
<http://world.casio.com/qv/register/>

Using an Eye-Fi Wireless SD Memory Card to Transfer Images (Eye-Fi)

Shooting with an Eye-Fi wireless SD memory card loaded in the camera makes it possible to transfer image data automatically to a computer via wireless LAN.

1. **Configure LAN access point, transfer destination and other settings for the Eye-Fi card in accordance with the instructions that come with the Eye-Fi card.**
2. **After configuring settings, load the Eye-Fi card into the camera and record.**

Images you record are sent by wireless LAN to your computer, etc.

 - For full details, see the user documentation that comes with the Eye-Fi card.
 - Before formatting a new Eye-Fi card to use it for the first time, copy the Eye-Fi Manager install files to your computer. Do this before formatting the card.

IMPORTANT!

- Recorded images are transferred over wireless LAN. Do not use the Eye-Fi card or turn off Eye-Fi card communication (page 104) when on an aircraft or in any other location where use of wireless communication is limited or prohibited.
- Loading an Eye-Fi card will cause the Eye-Fi indicator  to appear on the monitor screen. Its transparent or not transparent appearance indicates the communication status as shown below.



Transparent	Access point cannot be found or no transferable image data exists.
Not transparent	Image transfer in progress

- A communication icon  will appear on the monitor screen while image data transfer is in progress.
- The camera's Auto Power Off (page 110) function is disabled while image data transfer is in progress.
- A confirmation message will appear on the monitor screen if you try to turn off the camera while image data transfer is in progress. Follow the instructions in the messages (page 134).
- Transfer of a large number of images can take some time to complete.
- The original images remain on the Eye-Fi card after the image data transfer.
- Recording a movie to an Eye-Fi card may result in movie frames being dropped.
- Proper Eye-Fi card data communication may not be possible due to camera settings, battery level, or operating conditions.

Files and Folders

The camera creates a file and saves it each time you shoot a snapshot, record a movie, or perform any other operation that stores data. Files are grouped by storing them in folders. Each file and folder has its own unique name.

- For details about how folders are organized in memory, see “Memory Folder Structure” (page 102).

Name and Maximum Number Allowed	Example
File	
Each folder can contain up to 9999 files named CIMG0001 through CIMG9999. The extension on the file name depends on the file type.	26th file name: CIMG0026.JPG Serial number (4 digits) Extension
Folders	
Folders are named from 100CASIO to 999CASIO There can be up to 900 folders in memory. <ul style="list-style-type: none">• The BEST SHOT (page 49) includes a sample scene that optimizes settings for auction site images. Depending on your camera model, the sample scene is named either “For eBay” or “Auction”.<ul style="list-style-type: none">– Images recorded with the eBay scene are stored in a folder named “100_EBAY”.– Images recorded with the Auction scene are stored in a folder named “100_AUCT”.• BEST SHOT also has a scene named “For YouTube” that optimizes movie settings for recording movies for upload to YouTube. Images recorded with the YouTube scene are stored in a folder named “100YOUTB”.	100th folder name: 100CASIO Serial number (3 digits)

- You can view folder and file names on your computer. For details about how file names are displayed on the camera’s monitor screen, see page 12.
- The total number of folders and files allowed depends on the image size and quality, and capacity of the memory card being used for storage.

Memory Card Data

The camera stores images you shoot in accordance with the Design Rule for Camera File System (DCF).

■ About DCF

DCF is a standard that makes it possible to view and print images recorded on one manufacturer's camera on DCF-compliant devices produced by other manufacturers. You can transfer DCF-compliant images recorded with another camera to this camera and view them on this camera's monitor screen.

■ Memory Folder Structure

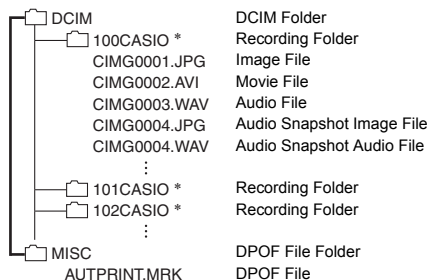

* Other folders are created when the following BEST SHOT scenes are used for recording: "For eBay" or "Auction" (scene name depends on camera model), or "For YouTube". The following shows the name of the folder created for each scene.

- eBay scene: 100_EBAY
- Auction scene: 100_AUCT
- YouTube scene: 100YOUTB

■ Supported Image Files

- Image files shot with this camera
- DCF-compliant image files

This camera may not be able to display an image, even if it is DCF-compliant. When displaying an image recorded on another camera, it may take a long time for the image to appear on this camera's monitor screen.

■ Built-in Memory and Memory Card Data Handling Precautions

- Whenever copying memory contents to your computer, you should copy the DCIM folder and all of its contents. A good way to keep track of multiple DCIM copies of the DCIM folders is to change its name to a date or something similar after you copy it to your computer. If you later decided to return the folder to the camera, however, be sure to change its name back to DCIM. The camera is designed to recognize only a root file with the name DCIM. Note the camera also will not be able to recognize the folders inside the DCIM folder unless they have the names they originally had when you copied them from the camera to your computer.
- Folders and files must be stored in accordance with the "Memory Folder Structure" shown on page 102 in order for the camera to be able to recognize them correctly.
- You also can use a PC card adapter or a memory card reader/writer to access camera files directly from the camera's memory card.

Other Settings (Set Up)

This section explains menu items that you can use to configure settings and perform other operations in both the REC mode and PLAY mode.



For information about menu operations, see page 52.

Selecting a REC Mode Screen Layout (Panel)

Procedure

[MENU] → Set Up Tab →  Panel

The REC mode screen layout settings let you select the layout of icons.

Off	<p>Turns off Control Panel display. This setting helps to view more of the image when the 16:9 aspect ratio is selected. Certain camera settings are indicated by icons on the image.</p> <ul style="list-style-type: none">Pressing [SET] while in the REC mode will cause the Control Panel to appear along the right side of the monitor screen. The Control Panel will disappear after you select an item and press [SET].	 A landscape photo of a lake and mountains. In the top right corner, there is a small orange house icon, the number '156', and 'UGA'. In the bottom right corner, there is a date '12/12/24' and a time '12:37'. Four small camera icons are overlaid on the image.
On	<p>Displays the Control Panel. All camera setting icons are cleared from the displayed image while the Control Panel is displayed.</p>	 The same landscape photo as above. On the right side, a vertical Control Panel is displayed, containing icons for various camera settings: a house icon, '156', 'USA', a camera icon, 'ISO', 'AWB', 'EU', and a battery icon. The date '12:37' is at the bottom right.

- All screen shots in this manual show what appears when the Control Panel is turned off.

Turning off Eye-Fi Card Communication (Eye-Fi)

Procedure



[MENU] → Set Up Tab → Eye-Fi

Select "Off" to disable Eye-Fi card communication (page 99).

Configuring Camera Sound Settings (Sounds)

Procedure

[MENU] → Set Up Tab → Sounds

Startup	
Half Shutter	Specifies the startup sound
Shutter	Sound 1 - 5: Built-in sounds (1 through 5) Off: Sound off
Operation	
Operation ()	Specifies the sound volume. This setting is also used as the audio level during video output (page 70).
Play ()	Specifies the volume of movie and Audio Snapshot audio output. This volume setting is not used during video output (from the USB/AV port).

- Setting a volume level of 0 mutes output.

Configuring a Startup Image (Startup)

Procedure

[MENU] → Set Up Tab → Startup

Display the image you want to use as your startup image and then select “On”.

- The startup image does not appear when you turn on the camera by pressing [] (PLAY).
- You can specify a snapshot you recorded as the startup image, or you can use the special startup image provided in the camera’s built-in memory.
- If you select an audio snapshot as the startup image, the audio will not play at startup.
- Formatting built-in memory (page 112) will delete the current startup image setting.

Specifying the File Name Serial Number Generation Rule (File No.)

Procedure

[MENU] → Set Up Tab → File No.

Use the following procedure to specify the rule that governs generation of the serial number used in file names (page 101).

Continue	Tells the camera to remember the last used file number. A new file will be named using the next sequential number, even if files are deleted or if a blank memory card is loaded. If a memory card is loaded and that card already has files stored on it and the largest sequential number in the existing file names is greater than the largest sequential number remembered by the camera, numbering of new files will start from the largest sequential number in the existing file names plus 1.
Reset	Restarts the serial number from 0001 whenever all files are deleted or when the memory card is replaced with a blank one. If a memory card is loaded and that card already has files stored on it, numbering of new files will start from the largest sequential number in the existing file names number plus 1.

Configuring World Time Settings (World Time)

Procedure

[MENU] → Set Up Tab → World Time

You can use the World Time screen to view the current time in a zone that is different from your Home City when you go on a trip, etc. World Time displays the current time in 162 cities in 32 time zones around the globe.

1. Use [▲] and [▼] to select “World” and then press [▶].

- To change the geographic area and city for the time where you normally use the camera, select “Home”.

2. Use [▲] and [▼] to select “City” and then press [▶].

- To change the “World” setting to summer time, use [▲] and [▼] to select “DST” and then select “On”. Summer time is used in some geographical areas to advance the current time setting by one hour during the summer months.

3. Use [▲], [▼], [◀], and [▶] to select the geographic area you want and then press [SET].

4. Use [▲] and [▼] to select the city you want and then press [SET].

5. Press [SET].



IMPORTANT!

- Before configuring World Time settings, make sure that the Home City setting is the place where you live or normally use the camera. If it isn't, select “Home” on the screen in step 1 and configure the Home City, date, and time settings as required (page 108).

Time Stamping Snapshots (Timestamp)

Procedure

[MENU] → Set Up Tab → Timestamp

You can configure the camera to stamp the recording date only, or date and time in the lower right corner of each snapshot.

- Once date and time information is stamped into a snapshot, it cannot be edited or deleted.

Example: December 19, 2010, 1:25 p.m.

Date	2010/12/19
Date&Time	2010/12/19 1:25pm
Off	No stamping of date and/or time

- Even if you do not stamp the date and/or time with Timestamp, you can do so later using the DPOF function or some printing application (page 83).
- Digital zoom is disabled while date stamping is turned on.

Setting the Camera's Clock (Adjust)

Procedure

[MENU] → Set Up Tab → Adjust

[▲] [▼]	Change the setting at the cursor location
[◀] [▶]	Move the cursor between settings
[BS]	Toggles between 12-hour and 24-hour format

When the date and time settings are what you want, press [SET] to apply them.

- You can specify a date from 2001 to 2049.
- Be sure to select your Home City (page 106) before setting the time and date. If you set the time and date while the wrong city is selected for your Home City, the times and dates of all of the World Time cities (page 106) will be wrong.

Specifying the Date Style (Date Style)

Procedure

[MENU] → Set Up Tab → Date Style

You can select from among three different styles for the date.

Example: December 19, 2010

YY/MM/DD	10/12/19
DD/MM/YY	19/12/10
MM/DD/YY	12/19/10

- This setting also affects the Control Panel date format as shown below (page 29).
YY/MM/DD or MM/DD/YY: MM/DD
DD/MM/YY: DD/MM

Specifying the Display Language (Language)

Procedure

[MENU] → Set Up Tab → Language

■ Specify the display language you want.

- ① Select the tab on the right.
- ② Select "Language".
- ③ Select the language you want.

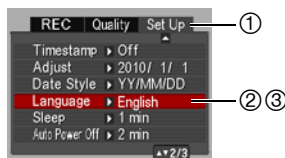

Configuring Sleep State Settings (Sleep)

Procedure

[MENU] → Set Up Tab → Sleep

This feature turns off the monitor screen whenever no camera operation is performed for a preset amount of time. Press any button to turn the monitor screen back on.

Trigger Time Settings: 30 sec, 1 min, 2 min, Off (Sleep is disabled while "Off" is selected.)

- Sleep is disabled under any of the following conditions.
 - In the PLAY mode
 - While the camera is connected to a computer or other device
 - During a slideshow
 - During Voice Recording playback or recording
 - During movie recording and playback
- When both sleep and Auto Power Off are turned on, Auto Power Off takes priority.

Configuring Auto Power Settings (Auto Power Off)

Procedure

[MENU] → Set Up Tab → Auto Power Off

Auto Power Off turns off the camera whenever no camera operation is performed for a preset amount of time.

Trigger Time Settings: 1 min, 2 min, 5 min (The trigger time is always 5 minutes in the PLAY mode.)

- Auto Power Off is disabled under any of the following conditions.
 - While the camera is connected to a computer or other device
 - During a slideshow
 - During Voice Recording playback or recording
 - During movie recording and playback

Configuring [📷] and [▶] Settings (REC/PLAY)

Procedure

[MENU] → Set Up Tab → REC/PLAY

Power On	Camera turns on whenever [📷] (REC) or [▶] (PLAY) is pressed.
Power On/Off	Camera turns on or off whenever [📷] (REC) or [▶] (PLAY) is pressed.
Disable	Camera does not turn on or off whenever [📷] (REC) or [▶] (PLAY) is pressed.

- With “Power On/Off”, the camera turns off when you press [📷] (REC) in the REC mode or [▶] (PLAY) in the PLAY mode.
- Change this setting to anything besides “Disable” before connecting to a TV for image viewing.

Configuring USB Protocol Settings (USB)

Procedure

[MENU] → Set Up Tab → USB

You can use the procedure below to select the USB communication protocol, which is used when exchanging data with a computer, printer, or other external device.

Mass Storage	Select this setting when connecting to a computer (pages 86, 95). With this setting, the computer sees the camera as an external storage device. Use this setting for normal transfer of images from the camera to a computer.
PTP (PictBridge)	Select this setting when connecting to a printer that supports PictBridge (page 79). This setting simplifies the transfer of image data to the connected device.

Selecting the Screen Aspect Ratio and Video Output System (Video Out)

Procedure

[MENU] → Set Up Tab → Video Out

You can use the procedure in this section to select either NTSC or PAL as the video output system. You can also specify an aspect ratio of 4:3 or 16:9.

NTSC	Video system used in Japan, the U.S., and other countries
PAL	Video system used in Europe and other areas
4:3	Normal TV screen aspect ratio
16:9	Wide screen aspect ratio

- Select the aspect ratio (4:3 or 16:9) that matches the type of TV you plan to use. Images will not display correctly if you select the wrong aspect ratio.
- Images will not display correctly unless the camera's video signal output setting matches the video signal system of the TV or other video equipment.
- Images cannot be displayed correctly on a TV or video equipment that is not NTSC or PAL.
- An optionally available AV cable (EMC-4A) is required for video output.

Formatting Built-in Memory or a Memory Card (Format)

Procedure

[MENU] → Set Up Tab → Format

If a memory card is loaded in the camera, this operation will format the memory card. It will format built-in memory if no memory card is loaded.

- The format operation will delete all contents on the memory card or in built-in memory. It cannot be undone. Make sure you do not need any data currently on the card or in built-in memory before you format it.
- Formatting built-in memory will delete the following data.
 - Protected images
- Formatting a memory card will delete the following data.
 - Protected images
- Make sure the camera's battery is sufficiently charged before starting a formatting operation. Formatting may not be performed correctly and the camera may stop operating normally if the camera powers down while formatting is in progress.
- Never open the battery cover while formatting is in progress. Doing so can cause the camera to stop operating normally.

Resetting the Camera to Factory Defaults (Reset)

Procedure

[MENU] → Set Up Tab → Reset

See page 127 for details about the camera's factory default settings.

The settings below are not reset.

World Time settings, clock settings, date style, screen language, video output

Configuring Monitor Screen Settings

You can turn display information on and off by pressing [▲] (DISP). You can configure separate settings for the REC mode and PLAY mode.

Information display on	Displays information about image settings, etc.
Information display + Histogram on	Turns on display of camera setting and other indicators, along with a histogram (page 114)  Histogram
Information display off	No information displayed

Using the On-screen Histogram to Check Exposure (+Histogram)

Displays a histogram on the monitor screen which you can use to check the exposure of an image before you shoot it. You also can display the histogram in the PLAY mode for information about the exposure levels of images.

- You can use key customization (page 61) to configure the [◀] and [▶] buttons so they control the EV shift setting (page 39), and perform EV shift while viewing the results on the on-screen histogram.

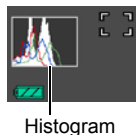

How to Use the Histogram

A histogram is a graph that represents the lightness of an image in terms of the number of pixels. The vertical axis indicates the number of pixels, while the horizontal axis indicates lightness. If the histogram appears too lopsided for some reason, you can use EV shift to move it left or right in order to achieve better balance. Optimum exposure can be achieved by EV shifting so the graph is as close to the center as possible. For snapshots, you can even display individual histograms for R (red), G (green), and B (blue).

Example Histograms

A histogram towards the left side results when the overall image is dark. A histogram that is too far to the left may result in “black out” of the dark areas of an image.

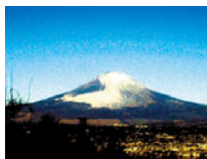

A histogram towards the right side results when the overall image is light. A histogram that is too far to the right may result in “white out” of the light areas of an image.



An overall well-balanced histogram results when the overall image is at optimal lightness.



NOTE

- A centered histogram does not necessarily guarantee optimum exposure. The recorded image may be over-exposed or under-exposed, even though its histogram is centered.
- Due to the limitations of exposure compensation, you may not be able to achieve an optimum histogram configuration.
- Use of the flash and certain shooting conditions can cause the histogram to indicate exposure that is different from the actual exposure of the image when it is shot.

Precautions during Use

■ Avoid Use While In Motion

- Never use the camera to record or play back images while operating an automobile or other vehicle, or while walking. Looking at the monitor while in motion creates the risk of serious accident.

■ Directly Viewing the Sun or Bright Light

- Never look at the sun or any other bright light through the camera's viewfinder. Doing so can damage your eyesight.

■ Flash

- Never use the flash unit in areas where flammable or explosive gas may be present. Such conditions create the risk of fire and explosion.
- Never fire the flash in the direction of a person operating a motor vehicle. Doing so can interfere with the driver's vision and create the risk of accident.
- Never fire the flash too close to the eyes of the subject. Doing so creates the risk of loss of eyesight.

■ Monitor Screen

- Do not apply strong pressure to the monitor screen surface or subject it to strong impact. Doing so can cause the monitor screen glass to crack.
- Should the monitor screen ever become cracked, never touch any of the liquid inside the monitor screen. Doing so creates the risk of skin inflammation.
- Should monitor screen liquid ever get into your mouth, immediately rinse your mouth out and contact your physician.
- Should monitor screen liquid ever get into your eyes or onto your skin, immediately rinse with clean water for at least 15 minutes and contact your physician.

■ Connections

- Never plug any devices that are not specified for use with this camera into connectors. Connecting a non-specified device creates the risk of fire and electric shock.

■ Transport

- Never operate the camera inside of an aircraft or anywhere else where operation of such devices is restricted. Improper use creates the risk of serious accident.

■ **Smoke, abnormal odor, overheating, and other abnormalities**

- Continued use of the camera while it is emitting smoke or strange odor, or while it is overheating creates the risk of fire and electric shock. Immediately perform the following steps whenever any of the above symptoms are present.
 1. Turn off the camera.
 2. Remove the battery from the camera, taking care to protect yourself against burn injury.
 3. Contact your dealer or nearest CASIO authorized service center.

■ **Water and Foreign Matter**

- Water, other liquids, or foreign matter (especially metal) getting inside the camera creates the risk of fire and electric shock. Immediately perform the following steps whenever any of the above symptoms are present. Particular care is required when using the camera where it is raining or snowing, near the ocean or other body of water, or in a bathroom.
 1. Turn off the camera.
 2. Remove the battery from the camera.
 3. Contact your dealer or nearest CASIO authorized service center.

■ **Dropping and Rough Treatment**

- Continued use of the camera after it is damaged by dropping or other rough treatment creates the risk of fire and electric shock. Immediately perform the following steps whenever any of the above symptoms are present.
 1. Turn off the camera.
 2. Remove the battery from the camera.
 3. Contact your dealer or nearest CASIO authorized service center.

■ **Keep Away From Fire**

- Never expose the camera to fire, which can cause it to explode and creates the risk of fire and electric shock.

■ **Disassembly and Modification**

- Never try to take the camera apart or modify it in any way. Doing so creates the risk of electric shock, burn injury, and other personal injury. Be sure to leave all internal inspection, maintenance, and repair up to your dealer or nearest CASIO authorized service center.

■ Locations To Be Avoided

- Never leave the camera in any of the following types of locations. Doing so creates the risk of fire and electric shock.
 - Areas subject to large amounts of humidity or dust
 - Food preparation areas or other locations where oil smoke is present
 - Near heaters, on a heated carpet, in areas exposed to direct sunlight, in a closed vehicle parked in the sun, or other areas subject to very high temperatures
- Never place the camera on an unstable surface, on a high shelf, etc. Doing so can cause the camera to fall, creating the risk of personal injury.

■ Backing Up Important Data

- Always keep backup copies of important data in camera memory by transferring it to a computer or other storage device. Note that data can be deleted in the case of camera malfunction, repair, etc.

■ Memory Protection

- Whenever replacing the battery, be sure to follow the correct procedure as described in the documentation that comes with the camera. Incorrectly replacing the battery can result in corruption or loss of data in camera memory.

■ Rechargeable Battery

- Use only the specified charger unit or the specified device to charge the battery. Attempting to charge the battery by an unauthorized means creates the risk of battery overheating, fire, and explosion.
- Do not expose or immerse the battery in fresh water or salt water. Doing so can damage the battery, and cause deterioration of its performance and loss of service life.
- The battery is intended for use with a CASIO Digital Camera only. Use with any other device creates the risk of the battery damage, or deterioration of battery performance and service life.
- Failure to observe any of the following precautions creates the risk of battery overheating, fire, and explosion.
 - Never use or leave the battery near open flame.
 - Do not expose the battery to heat or fire.
 - Make sure the battery is oriented correctly when it is connected to the charger unit.
 - Never carry or store the battery together with items that can conduct electricity (necklaces, pencil lead, etc.)
 - Never disassemble the battery, pierce it with a needle, or expose it to strong impact (hit it with a hammer, step on it, etc.), and never apply solder to it. Never place the battery into a microwave oven, heater, high-pressure generating device, etc.

- Should you ever notice leakage, strange odor, heat generation, discoloration, deformation, or any other abnormal condition while using, charging, or storing a battery, immediately remove it from the camera or charger unit and keep it away from open flame.
- Do not use or leave the battery under direct sunlight, in an automobile parked in the sun, or in any other area subject to high temperatures. Doing so can damage the battery, and cause deterioration of its performance and loss of service life.
- If battery charging does not end normally within the specified charging time, stop charging anyway and contact your local CASIO authorized service center. Continued charging creates the risk of battery overheating, fire, and explosion.
- Battery fluid can damage your eyes. Should battery fluid get into your eyes accidentally, immediately rinse them with clean tap water and then consult a physician.
- Be sure to read the user documentation that comes with the camera and special charger unit before using or charging the battery.
- If a battery is to be used by young children, make sure that a responsible adult makes them aware of the precautions and proper handling instructions, and make sure that they handle the battery correctly.
- Should fluid from a battery accidentally get onto clothing or your skin, immediately rinse it off with clean tap water. Prolonged contact with battery fluid can cause skin irritation.

■ Battery Life

- Battery continuous operation times provided in this manual represent the approximate amount of time before the camera turns off due to low battery power when being powered by the special battery under normal temperature (23°C (73°F)). They do not guarantee that you will be able to achieve the indicated level of operation. Actual battery life is greatly affected by ambient temperature, battery storage conditions, the amount of time spent in storage, etc.
- Leaving the camera on can run down the battery and cause the low battery warning to appear. Turn off the camera whenever you are not using it.
- The low battery warning indicates that the camera is about to turn off due to low battery power. Charge the battery as soon as possible. Leaving a low or dead battery in the camera can lead to battery leakage and data corruption.

■ Data Error Precautions

Your digital camera is manufactured using precision digital components. Any of the following creates the risk of corruption of data in camera memory.

- Removing the battery or memory card while the camera is performing some operation
- Removing the battery or memory card while the back lamp is flashing green after turning off the camera
- Disconnecting the USB cable while communication is in progress
- Using a battery that is low
- Other abnormal operations

Any of the above conditions can cause an error message to appear on the monitor screen (page 134). Perform the action indicated by the message that appears.

■ Operating Environment

- Operating Temperature: 0 to 40°C (32 to 104°F)
- Operating Humidity: 10 to 85% (non condensation)
- Do not place the camera in any of the following locations.
 - In an area exposed to direct sunlight, or large amounts of moisture, dust, or sand
 - Near an air conditioner or in other areas subjected to extreme temperature or humidity
 - Inside of a motor vehicle on a hot day, or in an area subjected to strong vibration

■ Condensation

Sudden and extreme temperature changes, such as when the camera is moved from the outdoors on a cold winter day into a warm room, can cause water droplets called “condensation” to form on the interior and the exterior of the camera, which creates the risk of malfunction. To prevent condensation from forming seal the camera in a plastic bag before changing locations. Then leave the bag sealed to allow the air inside to naturally change to the same temperature as the air in the new location. After that, remove the camera from the bag and open the battery cover for a few hours.

■ Lens

- Never apply too much force when cleaning the surface of the lens. Doing so can scratch the lens surface and cause malfunction.
- You may sometimes notice some distortion in certain types of images, such as a slight bend in lines that should be straight. This is due to the characteristics of lenses, and does not indicate malfunction of the camera.

■ Caring for your camera

- Never touch the lens or flash window with your fingers. Finger smudges, dirt, and other foreign matter on the lens or flash window can interfere with proper operation of the camera. Use a blower or other means to keep the lens and flash window free of dirt and dust, and wipe gently with a soft, dry cloth.
- To clean the camera, wipe it with a soft, dry cloth.

■ Old Rechargeable Battery Handling Precautions

- Insulate the positive and negative terminals with tape, etc.
- Do not peel the covering off of the battery.
- Do not try to take the battery apart.

■ Charger Unit Handling Precautions



- Never plug the power cord into an outlet whose voltage rating is different from that marked on the power cord. Doing so creates the risk of fire, malfunction, and electric shock.
 - Take care to protect the power cord against damage and breaking. Never place heavy objects onto the power cord, or expose it to intense heat. Doing so can damage the power cord, creating the risk of fire and electric shock.
 - Never try to modify the power cord, or subject it to severe bending, twisting, or pulling. Doing so creates the risk of fire, malfunction, and electric shock.
 - Never plug in or unplug the power cord while your hands are wet. Doing so creates the risk of electric shock.
 - Do not plug the power cord into an outlet or extension cord that is shared by other devices. Doing so creates the risk of fire, malfunction, and electric shock.
 - Should the power cord ever become damaged (to the point that internal wires are exposed or cut), immediately contact your original retailer or authorized CASIO authorized service center to request repair. Continued use of a damaged power cord creates the risk of fire, malfunction, and electric shock.
- The charger unit becomes slightly warm during charging. This is normal and does not indicate malfunction.
 - Unplug the power cord from the power outlet when you are not using the charger unit.
 - Never use detergent to clean the power cord (especially the plug).
 - Never cover the charger unit with a blanket, etc. Doing so creates the risk of fire.

■ Other Precautions

The camera becomes slightly warm during use. This is normal and does not indicate malfunction.

■ Copyrights

Except for your own personal enjoyment, unauthorized use of use of snapshots or movies of images whose rights belong to others, without the permission of the right holder, is forbidden by copyright laws. In some cases, shooting of public performances, shows, exhibitions, etc. may be restricted entirely, even if it is for your own personal enjoyment. Regardless of whether such files are purchased by you or obtained for free, posting them on a website, a file sharing site, or any other Internet site, or otherwise distributing them to third parties without the permission of the copyright holder is strictly prohibited by copyright laws and international treaties. For example, uploading or distributing on the Internet images of TV programs, live concerts, music videos, etc. that were photographed or recorded by you may infringe upon the rights of others. Note that CASIO COMPUTER CO., LTD. shall not be held liable for use of this product in any way that infringes on the copyrights of others or that violates copyright laws.

The following terms, which are used in this manual, are registered trademarks or trademarks of their respective owners.

Note that trademark ™ and registered trademark ® are not use within the text of this manual.

- The SDHC logo is a trademark.
- Microsoft, Windows, Internet Explorer, Windows Media, Windows Vista, and DirectX are registered trademarks or trademarks of Microsoft Corporation in the United States and other countries.
- Macintosh, Mac OS, QuickTime, and iPhoto are trademarks of Apple Inc.
- Adobe and Reader are trademarks or registered trademarks in the United States and other countries of Adobe Systems Incorporated.
- YouTube, the YouTube logo, and “Broadcast Yourself” are trademarks or registered trademarks of YouTube, LLC.
- EXILIM, Photo Transport, and YouTube Uploader for CASIO are registered trademarks or trademarks of CASIO COMPUTER CO., LTD.
- All other company or product names mentioned herein are registered trademarks or trademarks of their respective companies.

Any and all unauthorized commercial copying, distribution, and copying of the bundled software over a network are prohibited.

This product's YouTube upload functionality is included under license from YouTube, LLC. The presence of YouTube upload functionality in this product is not an endorsement or recommendation of the product by YouTube, LLC.

Power Supply

Charging

If the [CHARGE] lamp flashes red...

- Charging cannot be performed because ambient temperature or the temperature of the charger is too hot or too cold. Leave the camera in a location whose temperature is within the range where charging can be performed. When the camera returns to a temperature where charging can be performed, the [CHARGE] lamp will light red.
- Check if the charger and battery contacts are dirty. If contacts are dirty, wipe them clean with a dry cloth.

If problems continue to occur after you perform the above steps, it could mean that the battery is faulty. Contact your nearest CASIO authorized service center.

To replace the battery

1. Open the battery cover and remove the current battery.

With the monitor screen side of the camera facing upwards, slide the stopper in the direction indicated by the arrow in the illustration. After the battery pops out, pull it the rest of the way out of the camera.

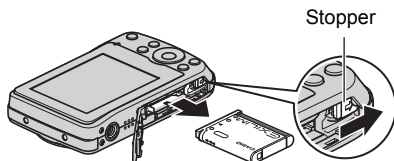

2. Load a new battery.

Battery Precautions

■ Precautions during Use

- Operation provided by a battery under cold conditions is always less than operation under normal temperatures. This is due to the characteristics of the battery, not the camera.
- Charge the battery in an area where the temperature is within the range of 5°C to 35°C (41°F to 95°F). Outside this temperature range charging can take longer than normal or even fail.
- Do not tear or remove the battery outer label.
- If a battery provides only very limited operation following a full charge, it probably means the battery has reached the end of its service life. Replace the battery with a new one.
- The included NP-82 battery is intended exclusively for use with this EXILIM digital camera. Never try to use it to power any other device. When purchasing a replacement or spare, be sure to purchase an NP-80 battery.

■ Storage Precautions

- Storing the battery for a long time while it is charged can cause deterioration of battery characteristics. If you do not plan to use a battery for some time, fully use up its charge before storing it.
- Always remove the battery from the camera when you are not using it. A battery left in the camera can discharge and go dead, which will require some time to charge when you need to use the camera.
- Store batteries in a cool, dry place (20°C (68°F) or lower).
- To prevent over discharging of an unused battery, fully charge it, and then load it in the camera and fully use up the charge about once every six months.

Using the Camera in another Country

■ Precautions during Use

- The bundled charger is designed for operation with any power supply in the range of 100V to 240V AC, 50/60Hz. Note, however, that the shape of the power cord plug depends on each country or geographic area. Before taking the camera and charger along on a trip, check with travel agent about the power supply requirements in your destination(s).
- Do not connect the charger to a power supply through a voltage converter or similar device. Doing so can lead to malfunction.

■ Extra Batteries

- Taking along extra fully charged batteries (NP-82 or NP-80) is recommended while on a trip in order to avoid not being able to shoot images due to the battery going dead.

Using a Memory Card

See page 19 for information about supported memory cards and how to load a memory card.

To replace the memory card

Press the memory card and then release it. This will cause it to pop out of the memory card slot slightly. Pull the card out the rest of the way and then insert another one.

- Never remove a card from the camera while the back lamp is flashing green. Doing so can cause the image save operation to fail and even damage the memory card.

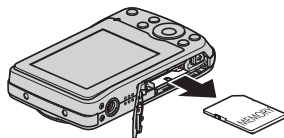

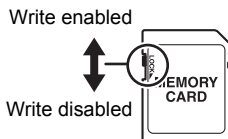

Using a Memory Card

- SD memory cards and SDHC memory cards have a write protect switch. Use the switch when you need to guard against accidentally deleting data. Note, however, if you write protect an SD memory card you must then turn write protection off whenever you want to record to it, format it, or delete any of its images.
- If a memory card starts to behave abnormally during image playback, you can restore normal operation by reformatting it (page 112). However, it is recommended that you always take along multiple memory cards whenever using the camera far away from the home or office.
- As you record data to and delete data from a memory card a number of times, it loses its ability to retain data. Because of this, periodic re-formatting of a memory card is recommended.
- Electrostatic charge, electrical noise, and other phenomena can cause data to become corrupted or even lost. Make sure that you always back up important data on other media (CD-R, CD-RW, hard disk, etc.)



■ Memory Card Handling Precautions

Certain types of cards can slow down processing speeds. In particular, you may experience problems saving high-quality (WIDE) movies. Use of certain types of memory cards increase the time it takes to record movies, which can cause movie frames to be lost. This condition is indicated by  and  flashing on the monitor screen. Use of a memory card with a maximum transfer speed of at least 10MB per second is recommended.

■ Discarding or Transferring Ownership of a Memory Card or the Camera

The format and delete functions of this camera just modify file management information of memory card and/or camera main memory. They do not actually modify the data itself. Note that management of your data is entirely your responsibility. To ensure data security, the following actions are recommended whenever you discard or transfer ownership of a memory card or the camera.

- When discarding a memory card and/or the camera, either physically destroy them or completely wipe out all of their data using commercially available software, etc.
- When transferring ownership of a memory card and/or the camera, completely wipe out all of their data using commercially available software, etc., and then use the camera's format function to format the memory card and/or camera main memory.

Computer System Requirements for Bundled Software

Computer system requirements are different for each of the applications. Be sure to check the requirements for the particular application you are trying to use. Note that the values provided here are minimum requirements for running each application. Actual requirements are greater, depending on the number of images and the sizes of the images being handled.

● Windows

YouTube Uploader for CASIO

Operating System: Windows Vista / XP (SP2/SP3) / 2000 (SP4)

Other : Sufficient memory to run the operating system

Computer configuration that enables playback of movies on the YouTube site

Computer configuration that enables upload of movies to the YouTube site

Photo Transport 1.0

Operating System : Windows Vista / XP / 2000

Memory : At least 64MB

Hard Disk Drive Space: At least 2MB

Adobe Reader 8

Operating System : Windows Vista / XP (SP2/SP3) / 2000 (SP4)

CPU : Pentium III Class

Memory : At least 128MB

Hard Disk Drive Space: At least 180MB

Other : Internet Explorer 6.0 or higher installed

For details about the minimum system requirements for each software application, see the “Read me” files on the CASIO Digital Camera Software CD-ROM that comes bundled with the camera.

Reset Initial Default Settings

The tables in this section show the initial default settings that are configured for menu items (displayed when you press [MENU]) after you reset the camera (page 112).

Menu items depend on whether the camera is in the REC mode or PLAY mode.

- A dash (–) indicates an item whose setting is not reset or an item for which there is no reset setting.

■ REC Mode

“REC” Tab

Focus	(Auto Focus)
Focus Frame	
CS	Off
Self-timer	Off
Face Detection	Off
Anti Shake	Off
AF Area	Spot
easy Mode	Off
L/R Key	Off
Grid	Off
Digital Zoom	On



Review	On
Icon Help	On
Memory	BEST SHOT: Off / Flash: On / Focus: Off / White Balance: Off / ISO: Off / AF Area: On / Metering: Off / CS: Off / Self-timer: Off / Flash Intensity: Off / Digital Zoom: On / MF Position: Off / Zoom Position: Off

“Quality” Tab

Size	10M (3648×2736)
Quality (Snapshots)	Normal
Quality (Movies)	STD
EV Shift	0.0
White Balance	Auto
ISO	Auto

Metering	Multi
Color Filter	Off
Sharpness	0
Saturation	0
Contrast	0
Flash Intensity	0

“Set Up” Tab

 Panel	Off
Eye-Fi	On
Sounds	Startup: Sound 1 / Half Shutter: Sound 1 / Shutter: Sound 1 / Operation: Sound 1 /  Operation: ■■■□□□□ /  Play: ■■■□□□□
Startup	Off
File No.	Continue
World Time	Home
Timestamp	Off

Adjust	–
Date Style	–
Language	–
Sleep	1 min
Auto Power Off	2 min
REC/PLAY	Power On
USB	Mass Storage
Video Out	–
Format	–
Reset	–

■ PLAY Mode

“PLAY” Tab

Slideshow	Time: 30 min / Interval: 3 sec / Effect: On
DPOF Printing	–
Protect	–
Rotation	–

Resize	–
Trimming	–
Dubbing	–
Copy	–







“Set Up” Tab



- The contents of the “Set Up” tab are the same in the REC mode and PLAY mode.

When things don't go right...

Troubleshooting

Problem	Possible Cause and Recommended Action
Power Supply	
Power does not turn on.	<ol style="list-style-type: none">1)The battery may not be loaded correctly (page 16).2)The battery may be dead. Charge the battery (page 15). If the battery goes dead soon after being charged, it means the battery has reached the end of its life and needs to be replaced. Purchase an optionally available CASIO NP-80 rechargeable lithium ion battery.
The camera suddenly powers down.	<ol style="list-style-type: none">1)Auto Power Off may have activated (page 110). Turn power back on.2)The battery may be dead. Charge the battery (page 15).3)The camera's protection function may have activated because camera temperature is too high. Turn off the camera and wait until it cools down before trying to use it again.
Power will not turn off. Nothing happens when a button is pressed.	Remove the battery from the camera and then reload it.
Image Recording	
Image is not recorded when the shutter button is pressed.	<ol style="list-style-type: none">1)If the camera is in the PLAY mode, press [RECORD] (REC) to enter the REC mode.2)If the flash is charging, wait until the charge operation finishes.3)If the message "Memory Full" appears, transfer images to your computer, delete images you no longer need, or use a different memory card.
Auto Focus does not focus properly	<ol style="list-style-type: none">1)If the lens is dirty, clean it off.2)The subject may not be in the center of the focus frame when you compose the image.3)The subject you are shooting may not be a type that is compatible with Auto Focus (page 28). Use manual focus (page 54).4)You may be moving the camera when shooting. Try shooting with Anti Shake (page 36) or use a tripod.

Problem	Possible Cause and Recommended Action
The subject is out of focus in the recorded image.	The image may not be focused properly. When composing the image, make sure the subject is located inside the focus frame.
The flash does not fire.	1) If  (Flash Off) is selected as the flash mode, change to another mode (page 33). 2) If the battery is dead, charge it (page 15). 3) If a BEST SHOT scene that uses  (Flash Off) is selected, change to a different flash mode (page 33) or select a different BEST SHOT scene (page 49).
A red  (Flash Off) icon appears on the monitor screen and the flash does not fire.	The flash unit may be malfunctioning. Contact a CASIO service center or your original retailer. Note that though the flash will not fire, you still can use the camera for non-flash shots.
Camera powers down during Self-timer countdown.	The battery may be dead. Charge the battery (page 15).
The monitor screen image is out of focus.	1) You may be using Manual Focus and have not focused the image. Focus the image (page 54). 2) You may be using  (Macro) for scenery or portraits. Use Auto Focus for scenery and portrait shots (page 54). 3) You may be trying to use Auto Focus or  (Infinity) when shooting a close-up shot. Use the  (Macro) for close ups (page 54).
There is a vertical line in the monitor screen image.	Shooting a very brightly lit subject can cause a vertical band to appear in the monitor screen image. This is a CCD phenomenon known as “vertical smear”, and does not indicate malfunction of the camera. Note that vertical smear is not recorded with the image in the case of a snapshot, but it is recorded in the case of a movie.
There is digital noise in images.	1) Sensitivity may have been increased automatically for a dark subject, which increases the chance of digital noise. Use a light or some other means to illuminate the subject. 2) You may be attempting to shoot in a dark location with  (Flash Off) selected, which can increase digital noise and make images appear coarse. In this case, turn on flash (page 33) or use lights for illumination.

Problem	Possible Cause and Recommended Action
A recorded image was not saved.	1) Camera power may have been turned off before the save operation was complete, which will result in the image not being saved. If the battery indicator shows  , charge the battery as soon as possible (page 17). 2) You may have removed the memory card from the camera before the save operation was complete, which will result in the image not being saved. Do not remove the memory card before the save operation is complete.
Though available lighting is bright, the faces of people in the image are dark.	Not enough light is reaching the subjects. Change the flash mode setting to  (Flash On) for daylight synchro flash (page 33), or adjust EV shift to the + side (page 39).
Night shots come out bad.	Use the following BEST SHOT scenes (page 49) when shooting at night. <ul style="list-style-type: none"> • Night Scene (for shooting night scenery only) • Night Scene Portrait (for shooting people against night scenery)
Subjects are too dark when shooting images in a seashore or ski area.	Sunlight reflected by water, sand, or snow, can cause underexposure of images. Change the flash mode setting to  (Flash On) for daylight synchro flash (page 33), or adjust EV shift to the + side (page 39).
Digital zoom (including HD zoom) does not work. The zoom bar indicates zoom only up to a zoom factor of 3.0.	1) The digital zoom setting may be turned off. Turn on digital zoom (page 62). 2) Date stamping may be turned on, which will cause digital zoom to be disabled. Turn off date stamping (page 107).
The image is out of focus during movie recording.	1) Focusing may not be possible because the subject is outside the focus range. Shoot within the allowable range. 2) The lens may be dirty. Clean the lens (page 119).

Problem	Possible Cause and Recommended Action
Playback	
The color of the playback image is different from what appears on the monitor screen when shooting.	Sunlight or light from another source may be shining directly into the lens when you are shooting. Position the camera so sunlight does not shine directly into the lens.
Images are not displayed.	This camera cannot display non-DCF images recorded onto a memory card using another digital camera.
Images cannot be edited (with resizing, trimming, rotation).	Note that you cannot edit the following types of snapshots. <ul style="list-style-type: none"> • Movies • Snapshots recorded with another camera
Other	
The wrong date and time are displayed, or the wrong date and time are being stored along with image data.	The date and time setting is off. Set the correct date and time (page 108).
The messages on the display are in the wrong language.	The wrong display language is selected. Change the display language setting (page 109).
Images cannot be transferred over a USB connection.	<ol style="list-style-type: none"> 1)The USB cable may not be connected securely. Check all connections. 2)The wrong USB communication protocol is selected. Select the correct USB communication protocol in accordance with the type of device you are connecting (pages 86, 95). 3)If the camera is not turned on, turn it on. 4)Your computer may not be able to recognize the camera if you connect via a USB hub. Always connect directly to the computer's USB port.

Problem	Possible Cause and Recommended Action
<p>Language selection screen appears when the camera is turned on.</p>	<p>1) You did not configure initial settings after purchasing the camera or the battery may have been left with a dead battery. Check the camera setup (pages 18, 109).</p> <p>2) There may be a problem with the camera's memory data. If this is the case, perform the reset operation to initialize the camera's setup (page 112). After that, configure each setting. If the language selection screen does not re-appear when you turn the camera on, it means that the camera's memory management data has been restored.</p> <p>If the same message appears after you turn power back on, contact your retailer or a CASIO authorized service center.</p>
<p>I configured the date and time settings after purchasing the camera, but they become incorrect after I remove the battery from the camera.</p>	<p>Load the camera's battery and reconfigure the time and date settings (page 18). Do not remove the battery from the camera for at least 24 hours after configuring time and date settings. After that, the settings will not be reset if you remove the battery.</p> <ul style="list-style-type: none"> • If you leave the battery loaded for more than 24 hours after setting the date and time, and they still become incorrect after you remove the battery, it could mean that the camera's setting memory is defective. Contact your retailer or a CASIO authorized service center.

Display Messages

ALERT	The camera's protection function may have activated because camera temperature is too high. Turn off the camera and wait until it cools down before trying to use it again.
Battery is low.	Battery power is low.
Card ERROR	<p>There is something wrong with the memory card. Turn off the camera, remove the memory card and then reload it into the camera. If this message re-appears when you turn the camera back on, format the memory card (page 112).</p> <p> IMPORTANT!</p> <ul style="list-style-type: none">• Formatting a memory card deletes all its files. Before formatting, try transferring recoverable files to a computer or some other storage device.
Check connections!	You are attempting to connect the camera to a printer while the camera's USB settings are not compatible with the USB system of the printer (page 79).
Files could not be saved because battery is low.	Battery power is low, so an image file could not be saved.
Folder cannot be created.	You are trying to record a file while there are already 9999 files stored in the 999th folder. If you want to record more, delete files you no longer need (page 27).
Images are being transferred. Stop transfer and turn off power?	You are attempting to turn off power while image data is being transferred using the Eye-Fi card (page 99).
LENS ERROR	This message appears and the camera turns off whenever lens performs some unexpected operation. If the same message appears after you turn power back on, contact a CASIO authorized service center or your original retailer.
Load paper!	The printer ran out of paper while printing.
Memory Full	Memory is full with images you recorded and/or files saved by editing operations. Delete files you no longer need (page 27).
Printing Error	<p>An error occurred while printing.</p> <ul style="list-style-type: none">• The printer is turned off.• The printer generated an error, etc.
Record Error	Image compression could not be performed for some reason during image data storage. Shoot the image again.

RETRY POWER ON	The lens came into contact with an obstruction while moving. The camera will turn off automatically when this message appears. Remove the obstruction and turn power back on again.
SYSTEM ERROR	Your camera system is corrupted. Contact your retailer or an authorized CASIO authorized service center.
The card is locked.	The LOCK switch of the SD or SDHC memory card loaded in the camera is in the locked position. You cannot store images to or delete images from a memory card that is locked. <div style="text-align: right;"> <p>LOCK</p>  </div>
There are no files.	There are no files in built-in memory or on the memory card.
There are no printing images. Set up DPOF.	There are currently no files specified for printing. Configure the required DPOF settings (page 81).
This card is not formatted.	The memory card loaded in the camera is not formatted. Format the memory card (page 112).
This file cannot be played.	The file you are trying to access is corrupted or is a type that cannot be displayed by this camera.
This function cannot be used.	You attempted to copy images from built-in memory to a memory card while there is no memory card loaded in the camera (page 77).

Number of Snapshots/Movie Recording Time/ Voice Recording Time

Snapshot

Image Size (Pixels)	Image Quality	Approximate Image File Size	Built-in Memory Snapshot Recording Capacity	SD Memory Card (1GB) Snapshot Recording Capacity
10M (3648×2736)	Fine	6.4 MB	2	150
	Normal	3.38 MB	4	285
	Economy	2.27 MB	7	425
3:2 (3648×2432)	Fine	5.6 MB	2	172
	Normal	2.97 MB	5	325
	Economy	2 MB	8	483
16:9 (3648×2048)	Fine	4.59 MB	3	210
	Normal	2.46 MB	6	392
	Economy	1.67 MB	9	578
7M (3072×2304)	Fine	4.3 MB	3	224
	Normal	2.31 MB	7	418
	Economy	1.57 MB	10	615
4M (2304×1728)	Fine	2.5 MB	6	386
	Normal	1.4 MB	11	690
	Economy	900 KB	18	1073
2M (1600×1200)	Fine	1.26 MB	12	766
	Normal	790 KB	20	1223
	Economy	470 KB	34	2056
VGA (640×480)	Fine	330 KB	49	2928
	Normal	190 KB	85	5085
	Economy	140 KB	116	6902

Movies

Image Quality (Pixels)	Approximate Data Rate (Frame Rate)	Built-in Memory Movie Recording Capacity	SD Memory Card (1GB) Movie Recording Capacity	File Size of 1-minute Movie
WIDE 848×480	12.5 Megabits/second (30 frames/second)	9 seconds	10 minutes 8 seconds	93.1 MB
STD 640×480	10.6 Megabits/second (30 frames/second)	10 seconds	11 minutes 43 seconds	79.0 MB
LP 320×240	2.7 Megabits/second (15 frames/second)	43 seconds	46 minutes 53 seconds	19.9 MB
YouTube 640×480	10.6 Megabits/second (30 frames/second)	10 seconds	11 minutes 43 seconds	79.0 MB

Voice Recording

File Format	Maximum File Size	File Size	Built-in Memory Voice Recording Capacity	SD Memory Card (1GB) Voice Recording Capacity
WAV IMA-ADPCM	4 GB	5.5 KB/second	50 minutes 8 seconds	49 hours 31 minutes

- * Snapshot, movie recording capacity, and voice recording capacity values are approximate and intended for reference only. Actual capacity depends on image contents.
- * File size and data rate values are approximate and intended for reference only. Actual values depend on the type of image being shot.
- * The above values are based on use of a PRO HIGH SPEED SD memory card (Panasonic Corporation). The number of images you can save depends on the type of memory card you are using.
- * When using a memory card with a different capacity, calculate the number of images as a percentage of 1GB.
- * Each movie can be up to 10 minutes long. Movie recording stops automatically after 10 minutes of recording.

Specifications

File Format	Snapshots: JPEG (Exif Version 2.2); DCF 1.0 standard; DPOF compliant Movies: Motion JPEG AVI, IMA-ADPCM audio (monaural) Audio (Voice Recording): WAV (monaural)
Recording Media	Built-in Memory (Image Storage Area: 16.9MB) SD/SDHC
Recorded Image Sizes	Snapshot: 10M (3648×2736), 3:2 (3648×2432), 16:9 (3648×2048), 7M (3072×2304), 4M (2304×1728), 2M (1600×1200), VGA (640×480) Movies: WIDE (848×480), STD (640×480), LP (320×240), YouTube (640×480)
Delete	1 file; all files (with memory protection feature)
Effective Pixels	10.1 Megapixels
Imaging Element	Size: 1/2.3-inch square pixel CCD Total Pixels: 10.34 Megapixels
Lens/Focal Distance	F3.1 (W) to 5.6 (T) f= 6.3 to 18.9 mm (equivalent to 35.5 to 106.5 mm in 35 mm format) Six lenses in five groups, including aspherical lens.
Zoom	3X optical zoom, 4X digital zoom (12X in combination with optical zoom) 17.1X maximum HD Zoom (in combination with optical zoom, VGA size)
Focusing	Contrast Detection Auto Focus • Focus Modes: Auto Focus, Macro Focus, Pan Focus, Infinity, Manual Focus • AF Area: Spot, Multi
Approximate Focus (Snapshot) (From Lens Surface)	Auto Focus: 10 cm to ∞ (3.9" to ∞) (Wide Angle) Macro Focus: 10 cm to 50 cm (3.9" to 19.7") (Wide Angle) Infinity: ∞ (Wide Angle) Manual: 10 cm to ∞ (3.9" to ∞) (Wide Angle) * Range is affected by optical zoom.
Metering	Multi-pattern, center weighted, and spot by imaging element
Exposure Control	Program AE
Exposure Compensation	-2.0 EV to +2.0 EV (in 1/3EV steps)
Shutter	CCD shutter, mechanical shutter
Shutter Speed	Snapshot (Auto): 1/2 to 1/2000 second Snapshot (Night Scene): 4 to 1/2000 second * May differ due to the camera setup.

Aperture Value	F3.1 (W) to F7.8 (W) (When used with ND filter) * Using optical zoom changes the aperture value.
White Balance	Auto, Daylight, Overcast, Shade, Day White Fluorescent, Daylight Fluorescent, Tungsten, Manual WB
Sensitivity (Standard Output Sensitivity, Recommended Exposure Index)	Snapshots: Auto, ISO 64, ISO 100, ISO 200, ISO 400, ISO 800, ISO 1600 Movies: Auto
Self-timer	Approximate Trigger Times: 10 seconds, 2 seconds, Triple Self-timer
Flash Modes	Auto, Off, On, Red-eye reduction
Flash Range (ISO Sensitivity: Auto)	Wide Angle: 0.1 m to 2.9 m (0.3' to 9.5') Telephoto: 0.4 m to 1.6 m (1.3' to 5.2') * Range is affected by optical zoom.
Flash Charging Time	Approximately 6 seconds maximum
Recording	Snapshots; Macro; Self-timer; Continuous Shutter (Normal Speed CS); BEST SHOT; Face Detection; easy Mode; Movies (normal movie and For YouTube) (with monaural audio); Audio (Voice Recording)
Approximate Maximum Audio Recording Times	After Recording: 30 seconds per image Voice Recording: 50 minutes 8 seconds (when using built-in memory)
Monitor Screen	2.5-inch TFT color LCD 230,400 (960×240) dots
Viewfinder	Monitor Screen
Timekeeping Function	Built-in quartz digital clock Date and Time: Recorded with image data With time stamp function Auto Calendar: To 2049
World Time	162 cities in 32 time zones City name, date, time, summer time
Input/Output Terminals	USB/AV port, Hi-Speed USB compatible
Microphone	Monaural
Speaker	Monaural
Power Requirements	Rechargeable lithium ion battery (NP-82 or NP-80) ×1

Approximate Battery Life

All of the values provided below represent the approximate amount of time under normal temperature (23°C (73°F)) before the camera turns off. These values are not guaranteed. Low temperatures shorten battery life.

Number of Shots (CIPA) (Operating Time)*¹	210 shots
Continuous Playback (Snapshots)*²	4 hours 10 minutes
Approximate continuous movie recording time	1 hour 40 minutes
Continuous Voice Recording*³	3 hours 40 minutes

- Battery: NP-82
(The same battery life values also apply to the optionally available NP-80 battery.)
- Recording Medium:
1GB SD memory card (PRO HIGH SPEED (Panasonic Corporation))
- Measurement Conditions

*¹ Approximate number of shots (CIPA) (Operating Time)

In accordance with CIPA (Camera and Imaging Products Association) standards
Normal temperature (23°C (73°F)), monitor on, zoom operation between full wide and full telephoto every 30 seconds, during which two images are shot with flash; power turned off and back on every time 10 images are shot.

*² Approximate playback time

Standard temperature (23°C (73°F)), one-image scroll approximately every 10 seconds

*³ Approximate continuous recording time

- The above values are based a new battery, starting from a full charge. Repeated charging shortens battery life.
- Frequency of flash, zoom, and Auto Focus usage, and the time the camera is on greatly affects recording time and number of shots values.

Power Consumption	3.7 V DC, Approximately 3.1 W
Dimensions	94.1 (W) × 56.1 (H) × 18.1 (D) mm (3.7" (W) × 2.2" (H) × 0.71" (D)) (excluding projections; 17.4 mm (0.69") at thinnest point)
Weight	Approximately 102 g (3.6 oz) (excluding battery and bundled accessories)

■ Rechargeable lithium ion battery (NP-82)

Rated Voltage	3.7 V
Rated Capacitance	710 mAh
Operating Temperature	0 to 40°C (32 to 104°F)
Dimensions	31.4 (W) × 39.5 (H) × 6.2 (D) mm (1.24" (W) × 1.56" (H) × 0.24" (D))
Weight	Approximately 15 g (0.53 oz)

■ Charger unit (BC-80L)

Input Power	100 to 240 V AC, 80 mA, 50/60 Hz
Output Power	4.2 V DC, 550 mA
Operating Temperature	5 to 35°C (41 to 95°F)
Supported Battery Type	Rechargeable lithium ion battery (NP-82 or NP-80)
Charging Time	100 minutes
Dimensions	52 (W) × 20 (H) × 81 (D) mm (2.0" (W) × 0.79" (H) × 3.2" (D)) (excluding projections)
Weight	Approximately 50 g (1.8 oz)

- Power cord precautions for use in Singapore
The power cord set is not supplied. The power cord used must comply with relevant national and/or international standards.

CASIO®

CASIO COMPUTER CO.,LTD.
6-2, Hon-machi 1-chome
Shibuya-ku, Tokyo 151-8543, Japan