

EXILIM

E

Digital Camera

EX-Z30/EX-Z40

User's Guide

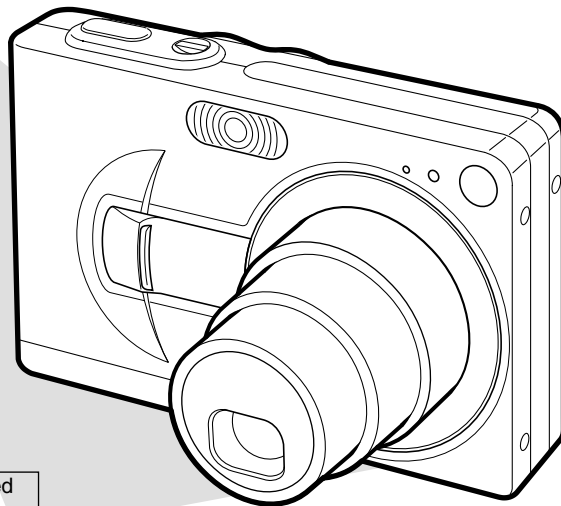

Thank you for purchasing this CASIO Product.

- Before using it, be sure to read the precautions contained in this User's Guide.
- Keep the User's Guide in a safe place for future reference.
- For the most up-to-date information about this product, visit the official Exilim Website at <http://www.exilim.com/>.

All example procedures in this User's Guide are based on the EX-Z40. The same procedures also apply to the EX-Z30, unless specifically noted otherwise.

©

K871PCM1DMX-2

CASIO®

INTRODUCTION

Unpacking

Check to make sure that all of the items shown below are included with your camera. If something is missing, contact your dealer as soon as possible.



Camera



Rechargeable lithium ion battery
(NP-40)

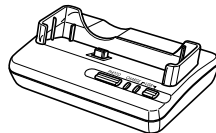

USB Cradle
(CA-24)

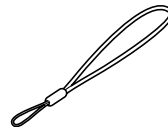

Strap



CD-ROM

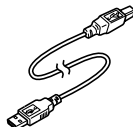

USB Cable



Basic Reference

- Note that the shape of the AC adaptor depends on the area where you purchased the camera.

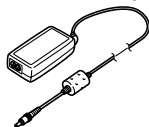

Special AC Adaptor (Inlet Type)

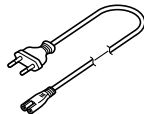

AC power cord *

* The shape of the AC power cord plug varies according to country or geographic area.

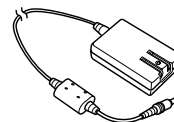

Special AC Adaptor (Plug-in Type)

Contents

2 INTRODUCTION

| | |
|--|----|
| Unpacking | 2 |
| Features | 9 |
| Precautions | 11 |
| General Precautions | 11 |
| Test for proper operation before using the camera! | 13 |
| Data Error Precautions | 13 |
| Operating conditions | 13 |
| Condensation | 14 |
| Lens | 14 |
| Other | 14 |

15 QUICK START GUIDE

| | |
|--|----|
| First, charge the battery! | 15 |
| To configure display language and clock settings | 16 |
| To record an image | 17 |
| To view a recorded image | 17 |
| To delete an image | 18 |

19 GETTING READY

| | |
|---|----|
| About This Manual | 19 |
| General Guide | 20 |
| Camera | 20 |
| USB Cradle | 21 |
| Monitor Screen Contents | 22 |
| REC mode | 22 |
| PLAY mode | 24 |
| Changing the Contents of the Monitor Screen | 25 |
| Indicator Lamps | 25 |
| Attaching the Strap | 26 |
| Power Requirements | 26 |
| To load the battery | 26 |
| To remove the battery | 28 |
| To charge the battery | 28 |
| Power Supply Precautions | 33 |
| Turning the Camera On and Off | 37 |
| Configuring Power Saving Settings | 38 |
| Using the On-screen Menus | 39 |
| Configuring Display Language and Clock Settings ... | 42 |
| To configure display language and clock settings | 43 |

45 BASIC IMAGE RECORDING

| | |
|---|----|
| Recording an Image | 45 |
| Aiming the Camera | 45 |
| Recording an Image | 46 |
| Recording Precautions | 48 |
| About Auto Focus | 49 |
| About the REC Mode Monitor Screen | 49 |
| Using the Optical Viewfinder | 50 |
| Using Zoom | 51 |
| Optical Zoom | 51 |
| Digital Zoom | 52 |
| Using the Flash | 53 |
| Flash Unit Status | 55 |
| Flash Precautions | 55 |
| Using the Self-timer | 56 |
| Specifying Image Size and Quality | 58 |
| To specify the image size | 58 |
| To specify image quality | 60 |

61 OTHER RECORDING FUNCTIONS

| | |
|--------------------------------|----|
| Selecting the Focus Mode | 61 |
| Using Auto Focus | 62 |
| Using the Macro Mode | 64 |
| Using the Pan Focus Mode | 64 |
| Using the Infinity Mode | 65 |
| Using Manual Focus | 65 |
| Using Focus Lock | 66 |

| | |
|--|----|
| Exposure Compensation (EV Shift) | 67 |
| Adjusting White Balance | 69 |
| Adjusting White Balance Manually | 70 |
| Using the BESTSHOT Mode | 71 |
| Creating Your Own BESTSHOT Setup | 73 |
| Combining Shots of Two People into a Single Image (Coupling Shot) | 75 |
| Recording a Subject onto an Existing Background Image (Pre-shot) | 77 |
| Using the Movie Mode | 79 |
| Recording Audio | 81 |
| Adding Audio to a Snapshot | 81 |
| Recording Your Voice | 83 |
| Using the Histogram | 84 |
| REC Mode Camera Settings | 86 |
| Specifying ISO Sensitivity | 86 |
| Turning the On-screen Grid On and Off | 88 |
| Turning Image Review On and Off | 88 |
| Assigning Functions to the [◀] and [▶] Keys | 89 |
| Specifying Power On Default Settings | 90 |
| Resetting the Camera | 91 |

92 PLAYBACK

| | |
|--|-----|
| Basic Playback Operation | 92 |
| Playing an Audio Snapshot | 93 |
| Flipping the Display | 94 |
| Zooming the Display Image | 95 |
| Resizing an Image | 96 |
| Cropping an Image | 97 |
| Playing a Movie | 99 |
| Displaying the 9-image View | 100 |
| Selecting a Specific Image in the 9-image View | 101 |
| Displaying the Calendar Screen | 101 |
| Playing a Slide Show | 102 |
| To specify the slideshow images | 104 |
| To specify the slideshow time | 105 |
| To set the slideshow interval | 105 |
| Using the Photo Stand Feature | 106 |
| Rotating the Display Image | 107 |
| Using Image Roulette | 108 |
| Adding Audio to a Snapshot | 109 |
| To re-record audio | 110 |
| Playing Back a Voice Recording File | 111 |

112 DELETING FILES

| | |
|------------------------------|-----|
| Deleting a Single File | 112 |
| Deleting All Files | 113 |

114 FILE MANAGEMENT

| | |
|--|-----|
| Folders | 114 |
| Memory Folders and Files | 114 |
| Protecting Files | 115 |
| To protect a single file | 115 |
| To protect all files in memory | 116 |
| Using the FAVORITE Folder | 116 |
| To copy a file to the FAVORITE folder | 116 |
| To display a file in the FAVORITE folder | 118 |
| To delete a file from the FAVORITE folder | 119 |
| To delete all files from the FAVORITE folder | 120 |

121 OTHER SETTINGS

| | |
|---|-----|
| Configuring Sound Settings | 121 |
| To configure sound settings | 121 |
| To set the volume level | 122 |
| Specifying an Image for the Startup Screen | 122 |
| Configuring Power Down Image Settings | 123 |
| Specifying the File Name Serial Number Generation Method | 125 |

INTRODUCTION

| | |
|--|-----|
| Using the Alarm | 126 |
| To set an alarm | 126 |
| Stopping the Alarm | 127 |
| Setting the Clock | 127 |
| To select your Home Time zone | 127 |
| To set the current time and date | 128 |
| Changing the Date Format | 129 |
| Using World Time | 129 |
| To display the World Time screen | 129 |
| To configure World Time settings | 130 |
| To configure summer time (DST) settings | 131 |
| Changing the Display Language | 132 |
| Changing the USB Port Protocol | 132 |
| Configuring [RECORD] (REC) and [PLAY] (PLAY) Buttons | |
| Power On/Off Functions | 133 |
| Formatting Built-in Memory | 135 |

136 USING A MEMORY CARD

| | |
|---|-----|
| Using a Memory Card | 137 |
| To insert a memory card into the camera | 137 |
| To remove a memory card from the camera | 138 |
| Formatting a Memory Card | 138 |
| Memory Card Precautions | 139 |
| Copying Files | 140 |
| To copy all the files in built-in memory to a memory card | 140 |
| To copy a file from a memory card to built-in memory | 141 |

142 PRINTING IMAGES

| | |
|--|-----|
| DPOF | 143 |
| To configure print settings for a single image | 144 |
| To configure print settings for all images | 145 |
| Using PictBridge or USB DIRECT-PRINT | 146 |
| To print a single image | 146 |
| To print a group of images | 148 |
| Printing Precautions | 149 |
| PRINT Image Matching II | 150 |
| Exif Print | 150 |

151 VIEWING IMAGES ON A COMPUTER

| | |
|--|-----|
| Using the Camera with a Windows Computer | 151 |
| USB Connection Precautions | 157 |
| Using the Camera with a Macintosh Computer | 157 |
| USB Connection Precautions | 161 |
| Operations You Can Perform from Your Computer | 161 |
| Using a Memory Card to Transfer Images to a Computer | 162 |
| Memory Data | 163 |
| DCF Protocol | 163 |
| Memory Directory Structure | 163 |
| Image Files Supported by the Camera | 165 |
| Built-in Memory and Memory Card Precautions | 165 |

166 USING THE CAMERA WITH A COMPUTER

| | |
|---|-----|
| Using the Album Feature | 166 |
| Creating an album | 166 |
| Selecting an Album Layout | 168 |
| Configuring Detailed Album Settings | 168 |
| Viewing Album Files | 171 |
| Saving an Album | 173 |
| To delete an album | 174 |
| Installing the Software from the CD-ROM | 174 |
| About the bundled CD-ROM | |
| (CASIO Digital Camera Software) | 174 |
| Computer System Requirements | 176 |
| Installing Software from the CD-ROM | |
| in Windows | 177 |
| Getting Started | 178 |
| Selecting a Language | 178 |
| Viewing the Contents of the "Read me" File | 178 |
| Installing an Application | 179 |
| Viewing User Documentation (PDF Files) | 179 |
| User Registration | 180 |
| Exiting the Menu Application | 180 |
| Installing Software from the CD-ROM on | |
| a Macintosh | 180 |
| Installing Software | 180 |
| Viewing User Documentation (PDF Files) | 181 |

183 APPENDIX

| | |
|--------------------------------|-----|
| Menu Reference | 183 |
| Indicator Lamp Reference | 185 |
| REC mode | 186 |
| PLAY mode | 187 |
| USB Cradle Indicator Lamps | 187 |
| Troubleshooting Guide | 188 |
| Display Messages | 192 |
| Specifications | 193 |
| Main Specifications | 193 |

►► IMPORTANT! ◀◀

- The contents of this manual are subject to change without notice.
- CASIO COMPUTER CO., LTD. assumes no responsibility for any damage or loss resulting from the use of this manual.
- CASIO COMPUTER CO., LTD. assumes no responsibility for any loss or claims by third parties which may arise through the use of the EX-Z30/EX-Z40.
- CASIO COMPUTER CO., LTD. shall not be held liable for any damages or losses suffered by you or any third party due to the use of Photo Loader and/or Photohands.
- CASIO COMPUTER CO., LTD. assumes no responsibility for any damage or loss caused by deletion of data as a result of malfunction, repairs, or battery replacement. Be sure to back up all important data on other media to protect against its loss.
- *The SD logo is a registered trademark.*
- *Windows, Internet Explorer, and DirectX are registered trademarks of Microsoft Corporation.*
- *Macintosh is a registered trademark of Apple Computer, Inc.*
- *MultiMediaCard is a trademark of Infineon Technologies AG of Germany, and licensed to the MultiMediaCard Association (MMCA).*
- *Acrobat and Acrobat Reader are trademarks of Adobe Systems Incorporated.*



- *The USB driver (mass storage) uses Phoenix Technologies Ltd. software.
Compatibility Software Copyright © 1997
Phoenix Technologies Ltd., All Rights Reserved.*
- *Other company, product and service names used herein may also be trademarks or service marks of others.*
- *Photo Loader and Photohands are the property of CASIO COMPUTER CO., LTD. Except as stipulated above, all copyrights and other related rights to these applications revert to CASIO COMPUTER CO., LTD.*

■ Copyright Restrictions

Except for the purposes of your own personal enjoyment, unauthorized copying of snapshot files, movie files, and audio files violates copyright laws and international contracts.

Distribution to third parties of such files over the Internet without permission of the copyright holder, whether for profit or for free, violates copyright laws and international contracts.

Features

- High-resolution CCD for beautiful prints
EX-Z30: 3.20 million pixels (3.34 million total pixels)
EX-Z40: 4.00 million pixels (4.23 million total pixels)
- 2.0-inch TFT color LCD monitor screen
- Long battery life
The camera's low-power design combines with a large-capacity battery to provide more recording and playback between charges.
- 12X seamless zoom (page 51)
3X optical zoom, 4X digital zoom
- 9.7MB Flash memory
Images can be recorded without using a memory card.
- REC mode or PLAY mode power up (page 37)
Press the  (REC) or  (PLAY) to turn on the camera and enter the mode you want to use.
- Multi Auto Focus (page 63)
When "Multi" is selected for the Auto Focus area, the camera takes simultaneous meter readings at seven different points and automatically selects the best one. This makes it possible to avoid erroneous focusing on the background, and ensure proper focus for a wide range of image types.
- Pan Focus (page 64)
This feature lets you lock the focus point and ensures that you do not miss that special moment when it happens.
- Auto Pan Focus (page 62)
When you press the shutter release all the way down without pausing, the camera immediately records the image without waiting for Auto Focus to be performed. This helps to avoid missing a special moment while you wait for the camera to Auto Focus.
- Support for SD memory cards and MMC (MultiMedia Cards) for memory expansion (page 136)
- Easy Charging (page 28)
Just place the camera onto the USB cradle to charge its battery.
- Easy Image Transfer (page 151)
Transfer images to a computer simply by placing the camera onto the USB cradle.
- Photo Stand feature (page 106)
A slideshow of images in file memory can be played while the camera is on its USB cradle.
- BESTSHOT (page 71)
Simply select the sample scene that matches the type of image you are trying to record and the camera performs troublesome setups automatically for beautiful pictures every time.
- Coupling Shot and Pre-shot (pages 75, 77)
Coupling Shot lets you combine two subjects into a single image, while Pre-shot lets you add a subject to a previously recorded background image. This means you can create images that include you and your friend, even if you are the only two people around. You can use Coupling Shot and Pre-shot by selecting the applicable sample images in the BESTSHOT mode.

INTRODUCTION

- **Triple Self-timer mode (page 56)**
The self-timer can be set up to repeat three times, automatically.
- **Real-time histogram (page 84)**
An on-screen histogram lets you adjust exposure as you view the effect on overall image brightness, which makes shooting under difficult lighting conditions easier than ever before.
- **World Time (page 129)**
A simple operation sets the current time for your current location. You can select from among 162 cities in 32 time zones.
- **Alarm (page 126)**
A built-in alarm helps to keep you on time for important events, and even can be used in place of an alarm clock. You can also have a specific image appear, or a movie or audio file to play when the alarm time is reached.
- **Album Function (page 166)**
HTML files are generated automatically to create an album of recorded images. Album contents can be viewed and printed using a standard Web browser. Images can also be incorporated into Web pages quickly and easily.
- **Calendar screen (page 101)**
A simple operation displays a full-month calendar on the camera's monitor screen. Each day of the full-month calendar shows a thumbnail of the first image recorded for that date, which helps to make searching for a particular image quicker and easier.
- **Snapshot + Audio Mode (page 81)**
Adds audio to a snapshot.
- **Movie + Audio Mode (page 79)**
- **Voice Recording (page 83)**
Quick and easy recording of voice input.
- **After Recording (page 109)**
Adds audio to images after they are recorded.
- **Selectable Sound Settings (page 121)**
You can configure different sounds to play whenever you turn on the camera, press the shutter release button half-way or all the way, or perform a key operation.
- **DCF Data Storage**
DCF (Design rule for Camera File system) data storage protocol provides image inter-compatibility between the digital camera and printers.
- **Digital Print Order Format (DPOF) (page 143)**
Images can be printed easily in the sequence you want using a DPOF compatible printer. DPOF can also be used when specifying images and quantities for printing by professional print services.

INTRODUCTION

- **PRINT Image Matching II Compatible (page 150)**
Images include PRINT Image Matching II data (mode setting and other camera setup information). A printer that supports PRINT Image Matching II reads this data and adjusts the printed image accordingly, so your images come out just the way you intended when you recorded them.
- **USB DIRECT-PRINT support (page 146)**
Your camera supports USB DIRECT-PRINT, which was developed by Seiko Epson Corporation. When connected directly to a printer that supports USB DIRECT-PRINT, you can select images to print and start the print operation directly from the camera.
- **PictBridge support (page 146)**
Your camera supports the PictBridge standard of the Camera and Imaging Products Association (CIPA). You can connect the camera directly to a printer that supports PictBridge, and perform image selection and printing using the camera monitor screen and controls.
- **Bundled with Photo Loader and Photohands (page 175)**
Your camera comes bundled with Photo Loader, the popular application that automatically loads images from your camera to your PC. It also comes with Photohands, and application that makes image retouching quick and easy.

Precautions

General Precautions

Be sure to observe the following important precautions whenever using the EX-Z30/EX-Z40.

All references in this manual to “this camera” and “the camera” refer to the CASIO EX-Z30/EX-Z40 Digital Camera.

- Never try to take pictures or use the built-in display while operating a motor vehicle or while walking. Doing so creates the danger of serious accident.
- Never try to open the case of the camera or attempt your own repairs. High-voltage internal components create the risk of electric shock when exposed. Always leave maintenance and repair work up to a CASIO authorized service center.
- Never look at the sun or any other bright light through the camera’s viewfinder. Doing so can damage your eyesight.
- Keep the small parts and accessories of this camera out of the reach of small children. If swallowed accidentally, contact your physician immediately.
- Never fire the flash in the direction of a person operating a motor vehicle. Doing so can interfere with the driver’s vision and create the danger of accident.

INTRODUCTION

- Never fire the flash while it is too close to the subject's eyes. Intense light from the flash can cause eye damage if it is fired too close to the eyes. This is especially true with young children. When using the flash, the camera should be at least one meter (3.3') from the eyes of the subject.
- Keep the camera away from water and other liquids, and never let it get wet. Moisture creates the danger of fire and electric shock. Never use the camera outdoors in the rain or snow, at the seashore or beach, in the bathroom, etc.
- Should foreign matter or water ever get into the camera, immediately turn it off. Next, remove the camera's battery and/or unplug the AC adaptor power cord from the power outlet, and contact your dealer or nearest CASIO authorized service center. Using the camera under these conditions creates the danger of fire and electric shock.
- Should you ever notice smoke or a strange odor coming out of the camera, immediately turn it off. Next, taking care you do not burn your fingers, remove the camera's battery and/or unplug the AC adaptor power cord from the power outlet, and contact your dealer or nearest CASIO authorized service center. Using the camera under these conditions creates the danger of fire and electric shock. After making sure there is no more smoke coming from the camera, take it to your nearest CASIO authorized service center for repair. Never attempt your own maintenance.
- Never use the AC adaptor to power any other device besides this camera. Never use any other AC adaptor besides the one that comes with this camera.
- Never cover the AC adaptor with a quilt, blanket, or other cover while it is in use, and do not use it near a heater.
- At least once a year, unplug the AC adaptor power cord from the power outlet and clean the area around the prongs of the plug. Dust build up around the prongs can create the danger of fire.
- If the camera's case should ever become cracked due to dropping it or otherwise subjecting it to rough treatment, immediately turn it off. Next, remove the camera's battery and/or unplug the AC adaptor power cord from the power outlet, and contact your dealer or nearest CASIO authorized service center.
- Never use the camera inside of an aircraft or in any other areas where its use is prohibited. Doing so can result in an accident.
- Physical damage and malfunction of this camera can cause the data stored in its memory to be deleted. Be sure to always keep backup copies of data by transferring them to personal computer memory.
- Never open the battery compartment cover, disconnect the AC adaptor from the camera, or unplug the AC adaptor from the wall socket while recording images. Doing so will not only make storage of the current image impossible, it can also corrupt other image data already stored in file memory.

Test for proper operation before using the camera!

Before using the camera to record important images, make sure you first record a number of test images and check the results to ensure that the camera is configured correctly and operating properly (page 17).

Data Error Precautions

- Your digital camera is manufactured using precision digital components. Any of the following creates the risk of corruption of data in file memory.
 - Removing the battery or memory card, or setting the camera onto the USB cradle while the camera is performing a record or memory access operation
 - Removing the battery, removing the memory card, or placing the camera onto the USB cradle while the operation lamp is still flashing after you turn off the camera
 - Disconnecting the USB cable, removing the camera from the USB cradle, or disconnecting the AC adaptor from the USB cradle while a data communication operation is being performed
 - Low battery power
 - Other abnormal operations

Any of the above conditions can cause an error message to appear on the monitor screen (page 192). Follow the instructions provided by the message to eliminate the cause of the error.

Operating conditions

- This camera is designed for use in temperatures ranging from 0°C to 40°C (32°F to 104°F).
- Do not use or keep the camera in the following areas.
 - In areas subject to direct sunlight
 - In areas subject to high humidity or dust
 - Near air conditioners, heaters, or other areas subject to temperature extremes
 - Inside of a closed vehicle, especially one parked in the sun
 - In areas subject to strong vibration

Condensation

- When you bring the camera indoors on a cold day or otherwise expose it to a sudden change of temperature, there is the possibility that condensation can form on the exterior or on interior components. Condensation can cause malfunction of the camera, so you should avoid exposing it to conditions that might cause condensation.
- To keep condensation from forming, place the camera into a plastic bag before moving it into a location that is much warmer or colder than your current location. Leave it in the plastic bag until the air inside the bag has a chance to reach the same temperature as the new location. If condensation does form, remove the battery from the camera and leave the battery compartment cover open for a few hours.

Lens

- Never apply too much force when cleaning the surface of the lens. Doing so can scratch the lens surface and cause malfunction.
- Fingerprints, dust, or any other soiling of the lens can interfere with proper image recording. Never touch the lens with your fingers. You can remove dust particles from the lens surface by using a lens blower to blow them off. Next, wipe the surface of the lens with a soft lens cloth.

Other

- The camera may become slightly warm during use. This does not indicate malfunction.
- If the exterior of the camera needs cleaning, wipe it with a soft, dry cloth.

QUICK START GUIDE

First, charge the battery!

1. Load the battery (page 26).

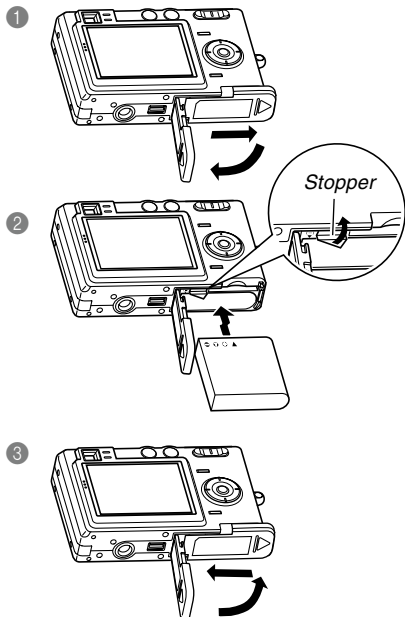

2. Place the camera onto the USB cradle to charge the battery (page 28).

- Note that the shape of the AC adaptor depends on the area where you purchased the camera.
- It takes about 190 minutes to achieve a full charge.

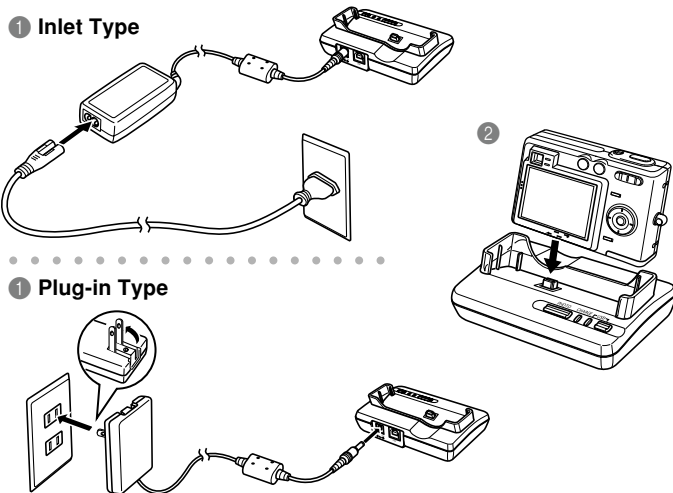

To configure display language and clock settings

- Be sure to configure the following settings before using the camera to record images. (See page 42 for details.)

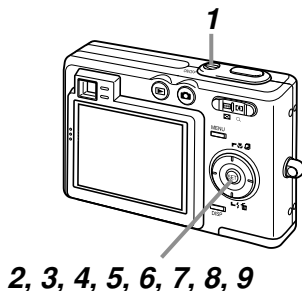

1. Press the power button to turn on the camera.
2. Press [▲] to select the language you want.
3. Press [SET] to register the language setting.
4. Use [▲], [▼], [◀], and [▶] to select the geographical area you want, and then press [SET].
5. Use [▲] and [▼] to select the city you want, and then press [SET].
6. Use [▲] and [▼] to select the summer time (DST) setting you want, and then press [SET].
7. Use [▲] and [▼] to select the date format setting you want, and then press [SET].
8. Set the date and the time.
9. Press [SET] to register the clock settings and exit the setting screen.

To record an image

(See page 45 for details.)

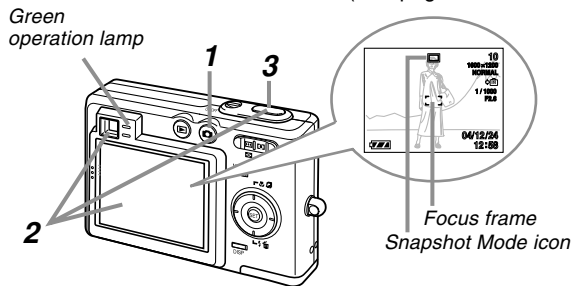

1. Press [RECORD] (REC).

- If the [Snapshot Mode] icon is not on the monitor screen, use the procedure under “Using the On-screen Menus” (page 39) to change the “REC Mode” setting to “[Snapshot Mode] Snapshot”.

2. Point the camera at the subject, use the monitor screen or viewfinder to compose the image, and then press the shutter release button half way.

- When proper focus is achieved, the focus frame turns green and the green operation lamp lights.

3. Holding the camera still, gently press the shutter release button.

To view a recorded image

(See page 92 for details.)

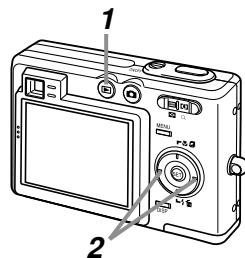

1. Press [PLAYBACK] (PLAY).

2. Use [LEFT] and [RIGHT] to scroll through the images.

To delete an image

(See page 112 for details.)

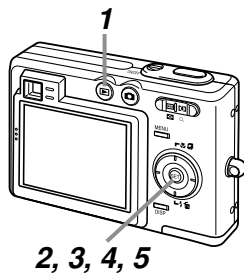

1. Press [▶] (PLAY).
2. Press [▼] (↓) (🗑️).
3. Use [◀] and [▶] to display the image you want to delete.
4. Use [▲] and [▼] to select “Delete”.
 - To exit the image delete operation without deleting anything, select “Cancel”.
5. Press [SET] to delete the image.

GETTING READY

This section contains information about things you need to know about and do before trying to use the camera.

About This Manual

This section contains information about the conventions used in this manual.

Terminology

The following table defines the terminology used in this manual.

| This term as used in this manual: | Means this: |
|-----------------------------------|--|
| "this camera" or "the camera" | The CASIO EX-Z30/EX-Z40 Digital Camera |
| "file memory" | The location where the camera is currently storing images you record (page 46) |
| "battery" | The NP-40 Rechargeable Lithium Ion Battery |
| "optional charger unit" | The optionally available CASIO BC-30L rapid Charger Unit |

Button Operations

Button operations are indicated by the button name inside of brackets ([]).

On-screen Text

On-screen text is always enclosed by double quotation marks (" ").

File Memory

The term "file memory" in this manual is a general term that refers to the location where your camera is currently storing the images you record. File memory can be any one of the following three locations.

- The camera's built-in Flash memory
- An SD memory card loaded in the camera
- A MultiMediaCard loaded in the camera

For more information about how the camera stores images, see page 114.

General Guide

The following illustrations show the names of each component, button, and switch on the camera.

Camera

■ Front

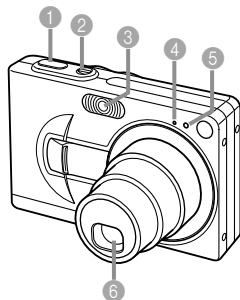

- ① Shutter release button
- ② Power button
- ③ Flash
- ④ Microphone
- ⑤ Self-timer lamp
- ⑥ Lens

■ Back

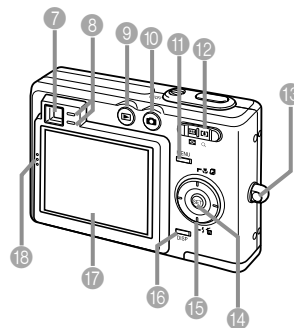

- ⑦ Viewfinder
- ⑧ Operation lamp
- ⑨ [▶] (PLAY mode)
- ⑩ [📷] (REC mode)
- ⑪ [MENU] button
- ⑫ Zoom button
- ⑬ Strap ring
- ⑭ [SET] button
- ⑮ [▲][▼][◀][▶]
- ⑯ [DISP] button
- ⑰ Monitor Screen
- ⑱ Speaker

■ Bottom

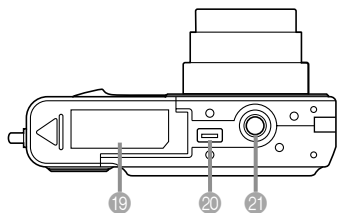

19 Battery compartment cover

20 Connector

21 Tripod screw hole

* Use this hole when attaching to a tripod.

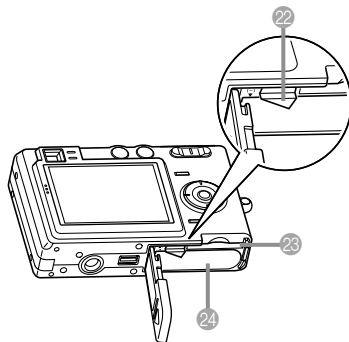

22 Stopper

23 Memory card slot

24 Battery compartment

USB Cradle

Simply placing your CASIO digital camera onto the USB cradle lets you perform the following tasks.

- Battery charging (page 28)
- Automatic transfer of images to a computer (page 151)
- Direct connection to a printer for printing (page 146)
- Viewing of images using the Photo Stand slideshow feature (page 106).

■ Front

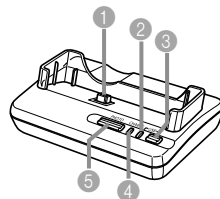

1 Camera connector

2 [USB] lamp

3 [USB] button

4 [CHARGE] lamp

5 [PHOTO] button

■ Back

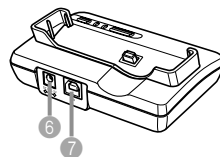

6 [DC IN 5.3V]
(AC adaptor connector)

7 [USB]
(USB port)

Monitor Screen Contents

The monitor screen uses various indicators and icons to keep you informed of the camera's status.

REC mode

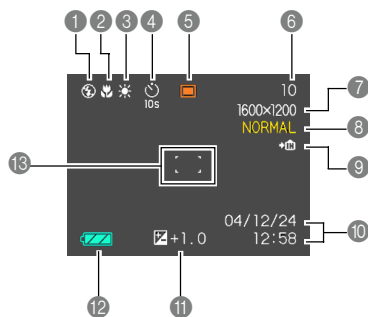

1 Flash Mode indicator

- None Auto
- Flash Off
 - Flash On
 - Red-eye reduction

- If the camera detects that flash is required while auto flash is selected, the flash on indicator will appear when the shutter release button is pressed half way.

2 Focus Mode indicator

- None Auto Focus
- Macro
 - Pan Focus
 - Infinity
 - Manual Focus

3 White balance indicator

- None Auto
- Sunlight
 - Overcast
 - Shade
 - Light Bulb
 - Fluorescent
 - Manual

4 Self-timer

- None 1-Image
- Self-timer 10 sec
 - Self-timer 2 sec
 - Triple self-timer

5 REC modes

- Snapshot
- BESTSHOT
- Movie
- Snapshot Audio
- Voice Recording

6 Memory capacity

- (Remaining number of storable images)
- Movie Recording: Remaining recording time

7 Image size

- EX-Z30
 - 2048 × 1536 pixels
 - 2048 × 1360 (3:2) pixels
 - 1600 × 1200 pixels
 - 1280 × 960 pixels
 - 640 × 480 pixels
- Movie Recording: recording time
- EX-Z40
 - 2304 × 1728 pixels
 - 2304 × 1536 (3:2) pixels
 - 1600 × 1200 pixels
 - 1280 × 960 pixels
 - 640 × 480 pixels
- Movie Recording: recording time

8 Quality

- FINE
NORMAL
ECONOMY

- 9 Built-in memory selected for data storage.
- Memory card selected for data storage.

10 Date and time

11 EV value

12 Battery capacity

13 Focus frame

- Focusing complete: Green
- Focusing failed: Red

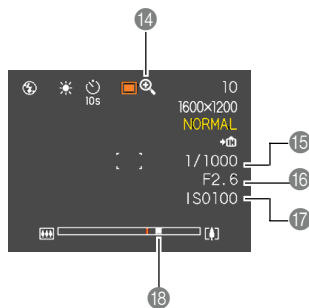

14 Digital zoom indicator

15 Shutter speed value

- An out of range aperture or shutter speed causes the corresponding monitor screen value to turn amber.

16 Aperture value

17 ISO sensitivity



18 Zoom indicator

- Left side indicates optical zoom.
- Right side indicates digital zoom.

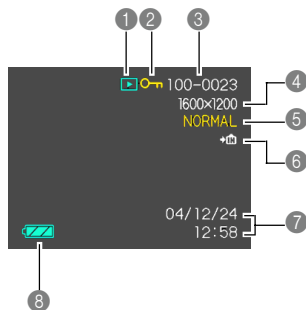
PLAY mode



1 PLAY mode file type

-  Snapshot
-  Movie
-  Snapshot Audio
-  Voice Recording

2 Image protection indicator



3 Folder number/File number

4 Image size

- EX-Z30
 - 2048 × 1536 pixels
 - 2048 × 1360 (3:2) pixels
 - 1600 × 1200 pixels
 - 1280 × 960 pixels
 - 640 × 480 pixels
 - Movie Playback: Elapsed play time
- EX-Z40
 - 2304 × 1728 pixels
 - 2304 × 1536 (3:2) pixels
 - 1600 × 1200 pixels
 - 1280 × 960 pixels
 - 640 × 480 pixels
 - Movie Playback: Elapsed play time

5 Quality

FINE
NORMAL
ECONOMY

- 6  Built-in memory selected for data storage.
-  Memory card selected for data storage.

7 Date and time

8 Battery capacity

▶▶ IMPORTANT! ◀◀

- Some information may not display properly if you display an image that was recorded using a different digital camera model.

Changing the Contents of the Monitor Screen

Each press of the [DISP] button changes the contents of the monitor screen as shown below.

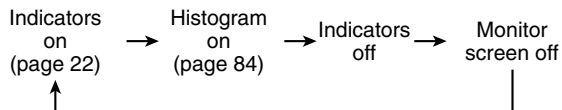

▶▶ IMPORTANT! ◀◀

- You cannot turn off the monitor screen in the following cases:
In the PLAY mode, in the BESTSHOT mode, when not recording in the Movie mode.
- You cannot use the [DISP] button to change the contents of the monitor screen while a movie is being recorded, or while standing by for or performing audio recording.
- In the Voice Recording mode, you can only turn indicators on and off.

Indicator Lamps

You can find out the operational status of the camera and the USB cradle at a glance by checking the color of the indicator lamps, and whether a lamp is lit or flashing. For details, see “Indicator Lamp Reference” on page 185.

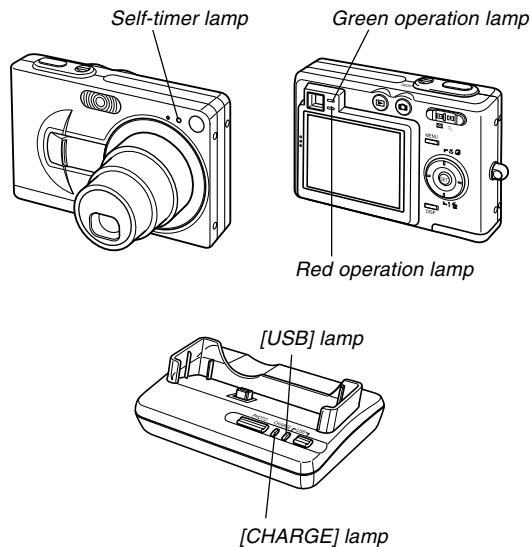

Attaching the Strap

Attach the strap to the strap ring as shown in the illustration.

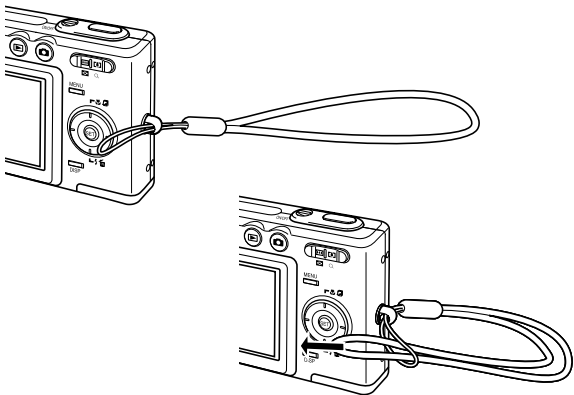

►► IMPORTANT! ◀◀

- Be sure to keep the strap around your wrist when using the camera to protect against accidentally dropping it.
- The supplied strap is intended for use with this camera only. Do not use it for any other purpose.
- Never swing the camera around by the strap.

Power Requirements

Your camera is powered by a rechargeable lithium ion battery (NP-40).

To load the battery

1. While pressing the battery compartment cover on the bottom of the camera, slide the cover in the direction indicated by the arrow, and then swing it open.

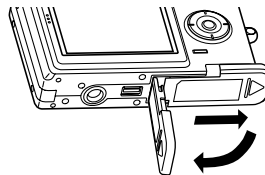

GETTING READY

2. While pulling the stopper in the direction indicated by the arrow in the illustration, align the (-) mark on the battery with the (-) mark on the camera and slide the battery into the camera.

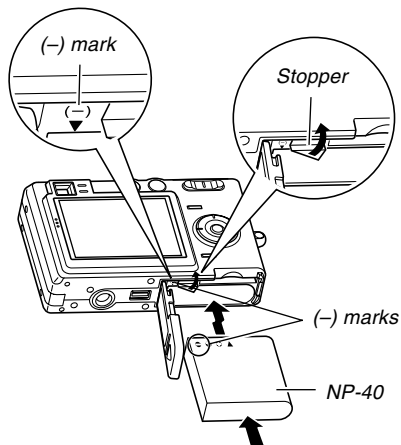

- Push the bottom of the battery, and make sure that the stopper securely locks the battery in place.

3. Swing the battery compartment cover closed, and then slide it in the direction indicated by the arrow.

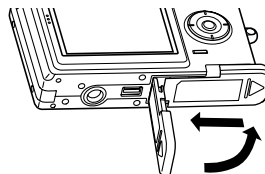

▶▶ IMPORTANT! ◀◀

- Use only the special NP-40 rechargeable lithium ion battery to power this camera. Use of any other type of battery is not supported.

The battery is not charged when you purchase the camera. You need to charge the battery before using the camera for the first time (page 28).

To remove the battery

1. Open the battery compartment cover.
2. Pull the stopper in the direction indicated by the arrow.
 - This will cause the battery to come part way out of the slot.

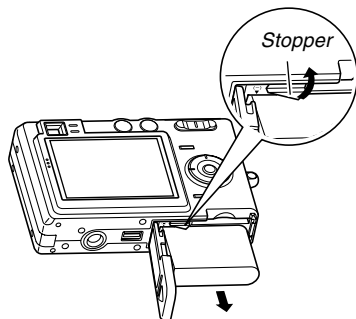

3. Release the stopper and pull the battery from the camera.

- Take care so you do not drop the battery.

To charge the battery

1. Connect the bundled AC adaptor to the [DC IN 5.3V] connector of the USB cradle, and then plug it in to a household power outlet.
 - Note that the shape of the AC adaptor depends on the area where you purchased the camera.

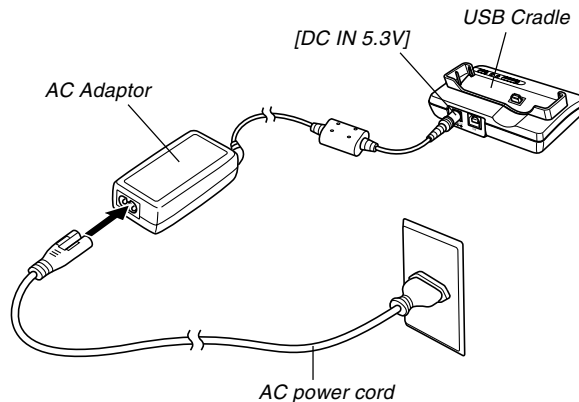

GETTING READY

NOTE

- The bundled AC adaptor is designed for operation with any power supply in the range of 100V to 240V AC. Note, however, that the shape of the AC power cord plug varies according to country or geographic area. If you plan to use the AC adaptor in a geographic area where the power receptacle shape is different from that in your area, replace the AC power cord with one of the other ones that comes with the camera, or purchase a commercially available AC power cord that is compatible with the power outlets in that area.

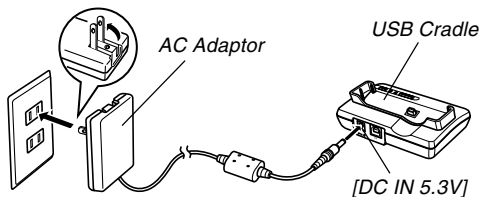

NOTE

- The AC adaptor is designed for operation on power ranging from 100V AC to 240V AC. Note, however, that the shape of the power cord plug varies according to country or geographic area. It is up to you to find out if the shape of the AC adaptor power cord plug is compatible with local power outlets when traveling abroad.

2. Turn off the camera.

3. Set the camera onto the USB cradle.

- Do not place the camera onto the USB cradle while it is turned on.
- The [CHARGE] lamp on the USB cradle should turn red, indicating that charging has started. When charging is complete, the [CHARGE] lamp will turn green.

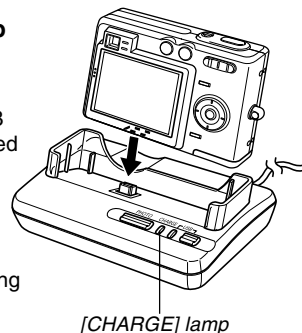

4. After charging is complete, remove the camera from the USB cradle.

▶▶ IMPORTANT! ◀◀

- It takes about 190 minutes to achieve a full charge. Actual charging time depends on current battery capacity and charging conditions.
 - Use only the USB cradle (CA-24) that comes with the camera or the optionally available rapid charger unit (BC-30L) to charge the special NP-40 rechargeable lithium ion battery. Never use any other charging device.
 - Use only the bundled AC adaptor. Never use any other type of AC adaptor. Do not use optionally available AD-C40, AD-C620 and AD-C630 AC adaptors with this camera.
 - Make sure that the camera connector of the USB cradle is securely inserted into the camera's connector as far as it will go.
 - The [CHARGE] lamp may remain amber colored and the charge operation may not start right away if you try to charge immediately after using the camera (which causes battery to become warm) or when it is too hot or too cold where you are performing the charge operation. If this happens, simply wait until the battery reaches normal temperature. The [CHARGE] lamp will turn red and charging will start when the battery temperature returns to the allowable charging temperature range.
- If the [CHARGE] lamp starts flashing red, it means that an error occurs while charging. An error can be caused by any of the following: a problem with the USB cradle, a problem with the camera, or a problem with the battery or how it is loaded. Remove the camera from the USB cradle and see if it works normally.
 - You can use the USB cradle to charge the camera's battery, to exchange data with a computer over a USB connection, or when using the Photo Stand feature only.

■ If the camera works normally

1. **Continue using the camera until the current charge is used up, and then charge the battery.**

■ If the camera does not work normally

This can mean there is a problem with how the battery is loaded.

1. **Remove the battery from the camera and check the battery contacts for dirt. If the contacts are dirty, wipe them clean with a dry cloth.**
2. **Check to make sure that the AC adaptor's power cord is connected securely to the power outlet and USB cradle.**
 - If the same symptoms occur again when you place the camera on the USB cradle after taking the above steps, contact a CASIO authorized service center.

■ Battery Life Guidelines

The battery life guideline values given below indicate the amount of time under the conditions defined below the table, until power automatically turns off due to battery failure. They do not guarantee that the battery will provide the amount of service indicated. Low temperatures and continued use reduce battery life.

| Model | EX-Z30 | EX-Z40 |
|---|-----------------------------|-----------------------------|
| Operation | Apporoximate Battery Life | Apporoximate Battery Life |
| Number of Shots (CIPA)* ¹ (Operating Time) | 360 shots (180 minutes) | 360 shots (180 minutes) |
| Number of Shots, Continuous Recording* ² (Operating Time) | 1260 shots (210 minutes) | 1140 shots (190 minutes) |
| Continuous Playback* ³ (Continuous Snapshot Recording) | 360 minutes | 360 minutes |
| Continuous Voice Recording* ⁴ | 300 minutes | 300 minutes |

GETTING READY

Supported Battery: NP-40 (Rated Capacitance: 1230mAh)
Storage Medium: SD Memory Card

*1 Number of Shots (CIPA)

- CIPA Standard
- Temperature: 23°C (73°F)
- Monitor Screen: On
- Zoom operation between full wide to full telephoto every 30 seconds, during which two images are recorded, one image with flash; power turned off and back on every time 10 images are recorded.

*2 Continuous Recording Conditions

- Temperature: 23°C (73°F)
- Monitor screen: On
- Flash: Off
- Image recorded every 10 seconds, alternating full wide-angle and full telephoto zoom

*3 Continuous Playback Conditions

- Temperature: 23°C (73°F)
- Scroll one image about every 10 seconds



*4 Voice recording times are based on continuous recording.



- The above values are based on a new battery starting from a full charge. Repeated charging shortens battery life.
- Battery life is greatly affected by how much you use flash, zoom and other functions, and how long you leave power turned on.





■ Tip to Make the Battery Last Longer

- If you do not need the flash while recording, select  (flash off) for the flash mode. See page 53 for more information.
- You can also conserve battery power by using the [DISP] button to turn off the monitor screen.

■ Low Battery Indicator

The following shows how the battery capacity indicator on the monitor screen changes as battery power is used. The  indicator means that remaining battery power is low. Note that you will not be able to record images while the battery indicator is . Charge the battery immediately whenever either of these indicators appears.

The following shows how the battery capacity indicator on the monitor screen changes as battery power is used. The  indicator means that remaining battery power is low. Note that you will not be able to record images while the battery indicator is . Charge the battery immediately whenever either of these indicators appears.

| | |
|---------------|---|
| Battery Level | High ←————→ Low |
| Indicator |  →  →  →  |

Power Supply Precautions

Note the following precautions when handling or using the battery and the optional charger unit.

■ Battery Handling Precautions

● SAFETY PRECAUTIONS

Be sure to read the following Safety Precautions before trying to use the battery for the first time. Keep these safety precautions and all operating instructions on hand for future reference.

»» NOTES ««

- The term “battery” in this manual refers to the CASIO NP-40 Rechargeable Lithium Ion Battery.
- Use only the USB cradle (CA-24) that comes with the camera or the optionally available rapid charger unit (BC-30L) to charge the special NP-40 rechargeable lithium ion battery. Never use any other charging device.

GETTING READY

- Failure to observe any of the following precautions while using the battery creates the risk of overheating, fire, and explosion.
 - Never use any other type of charger except the optional charger unit specified for the battery.
 - Never try to use the battery to power any other device other than this camera.
 - Never use or leave the battery near open flame.
 - Never place the battery in a microwave oven, throw it into fire, or otherwise expose it to intense heat.
 - Make sure the battery is oriented correctly when you load it into the camera or attach it to the optional charger unit.
 - Never carry or store the battery together with items that can conduct electricity (necklaces, pencil lead, etc.)
 - Never try to take the battery apart, modify it in any way, or expose it to strong impact.
 - Do not immerse the battery in fresh water or salt water.
 - Do not use or leave the battery under direct sunlight, in an automobile parked in the sun, or in any other area subject to high temperatures.
- Should you ever notice leakage, strange odor, heat generation, discoloration, deformation, or any other abnormal condition while using, charging, or storing a battery, immediately remove it from the camera or optional charger unit and keep it away from open flame.
- If the battery does not achieve full charge after the normal charging time has passed, stop charging. Continued charging creates the risk of overheating, fire, and explosion.
- Battery fluid can damage your eyes. Should battery fluid get into your eyes accidentally, immediately rinse them with clean tap water and then consult a physician.
- Be sure to read page 28 of this User's Guide and the instructions that come with the optional charger unit before using or charging the battery.
- If the battery is to be used by young children, make sure that a responsible adult makes them aware of the precautions and proper handling instructions and make sure that they handle the battery correctly.
- Should fluid from the battery accidentally get onto clothing or your skin, immediately rinse it off with clean tap water. Prolonged contact with battery fluid can cause skin irritation.

● PRECAUTIONS DURING USE

- The battery is designed for use with this CASIO digital camera only.
- Use only the USB cradle that comes with the camera or the specified optional charger unit to charge the battery. Never use any other type of charger unit for charging.
- A new battery is not charged. Be sure to charge the battery before using it for the first time.
- Use of a battery in cold environments shortens the operating time you can expect on a full charge. Charge the battery in a location where the temperature is in the range of 10°C to 35°C (50°F to 95°F). Charging outside this temperature range can cause charging to take longer than normal or even cause charging to fail.
- Very limited operation following a full charge indicates that the battery has reached the end of its service life. Replace the battery with a new one.
- Never wipe the battery with thinner, benzene, alcohol, or other volatile agents or chemically treated rags. Doing so can cause deformation of the battery and lead to malfunction.

● BATTERY STORAGE PRECAUTIONS

- Make sure you remove the battery when you do not plan to use the camera for a long time. A battery left in the camera discharges very small amounts of power even when power is turned off, which can lead to a dead battery or the need for longer charging before the next use.
- Store the battery in a cool, dry place (20°C (68 °F) or lower).

● USING THE BATTERY

- See page 28 of this manual or the instructions that come with the optional charger unit for information about charging procedures and charging times.
- When transporting a battery, keep it either loaded in the camera or stored in its case.

■ USB Cradle and AC Adaptor Precautions



Caution!

- Never use an electrical outlet whose voltage is outside the rating marked on the AC adaptor. Doing so can create the danger of fire or electric shock. Use only the bundled AC adaptor specified for this camera.
- Do not allow the AC adaptor cord to become cut or damaged, do not place heavy objects on it, and keep it away from heat. A damaged power cord creates the risk of fire and electric shock.
- Never try to modify the AC adaptor cord, or subject it to severe bending, twisting, or pulling. Doing so creates the risk of fire and electric shock.
- Never touch the AC adaptor while your hands are wet. Doing so creates the risk of electric shock.
- Do not overload extension cords or wall outlets. Doing so creates the danger of fire and electric shock.
- Should the cord of the AC adaptor become damaged (exposed internal wiring), request a replacement from a CASIO authorized service center. A damaged AC adaptor cord creates the danger of fire or electric shock.



Caution!

- Use the AC adaptor where it will not be splashed with water. Water creates the risk of fire and electric shock.
- Do not place a vase or any other container filled with liquid on top of the AC adaptor. Water creates the risk of fire and electric shock.
- Make sure you always remove the camera from the USB cradle before connecting or disconnecting the AC adaptor.
- Charging, USB data communication, and using the Photo Stand feature can cause the AC adaptor to become warm. This is normal and does not indicate malfunction.
- Unplug the AC power cord from the power outlet whenever you are not using it.
- Never place a blanket or any other cover on the AC adaptor. Doing so creates the risk of fire.

Turning the Camera On and Off

■ To turn on the camera

Press the power button, [📷] (REC) button, or [▶] (PLAY) button. This will cause the green operation lamp to light momentarily, and then power will turn on. The mode the camera enters depends on which button you pressed to turn it on.

| To enter this mode at startup: | Press this button to turn on the camera: |
|--------------------------------|--|
| REC | Power button or [📷] (REC) button |
| PLAY | [▶] (PLAY) button |

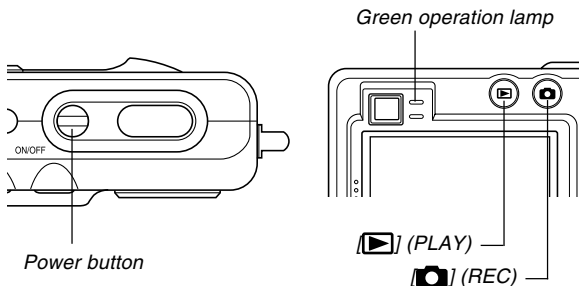

▶▶ NOTES ◀◀

- Pressing [📷] (REC) to turn on the camera enters the REC mode, while pressing [▶] (PLAY) enters the PLAY mode.
- Pressing [▶] (PLAY) while in the REC mode switches to the PLAY mode. The lens retracts about 10 seconds after switching modes.

▶▶ IMPORTANT! ◀◀

- If camera power is turned off by the Auto Power Off feature, press the power button, [📷] (REC) or [▶] (PLAY) to turn it back on again.
- Pressing the power button or [📷] (REC) to turn on the camera also causes the lens to extend. Take care to any interference with the lens operation or allowing anything to strike the lens when it is extended.

■ To turn off the camera

Press the power button to turn off the camera.

»» NOTE ««

- You can setup the camera so it does not turn on when you press the [RECALL] (REC) or [PLAY] (PLAY) button, or to turn off when you press the [RECALL] (REC) or [PLAY] (PLAY) button. For details, see “Configuring [RECALL] (REC) and [PLAY] (PLAY) Buttons Power On/Off Functions” on page 133.

Configuring Power Saving Settings

You can configure the settings described below to conserve battery power.

- Sleep** : Automatically turns off the monitor screen if no operation is performed for a specified amount of time in the REC mode. Performing any button operation causes the monitor screen to turn back on.
- Auto Power Off** : Turns off power if you do not perform any operation for a specified amount of time.

1. Turn on the camera.
2. Press [MENU].
3. Use [LEFT] and [RIGHT] to select the “Set Up” tab.
4. Use [UP] and [DOWN] to select the feature whose setting you want to configure, and then press [RIGHT].

GETTING READY

- See page 39 for information about how to use menus.

| To configure this feature: | Select this setting: |
|----------------------------|----------------------|
| Sleep | Sleep |
| Auto Power Off | Auto Power Off |

5. Use [▲] and [▼] to change the currently selected setting, and then press [SET].

- Available Sleep settings are: “30 sec”, “1 min”, “2 min”, and “Off”.
- Available Auto Power Off settings are: “2 min” and “5 min”.
- Note that the Sleep feature does not operate in the PLAY mode.
- Pressing any button while the camera is in the Sleep state immediately turns the monitor screen back on.
- The Auto Power Off and Sleep features are disabled in the following cases.
 - When the camera is connected to a computer or some other device through the USB cradle
 - While a slideshow is in progress
 - While playing back a voice recording file

Using the On-screen Menus

Pressing [MENU] displays menus on the monitor screen that you can use to perform various operations. The menu that appears depends on whether you are in the REC mode or the PLAY mode. The following shows an example menu procedure in the REC mode.

1. Press the power button or the [CAM] (REC) button.

- If you want to enter the PLAY mode instead, press the [▶] (PLAY) button.

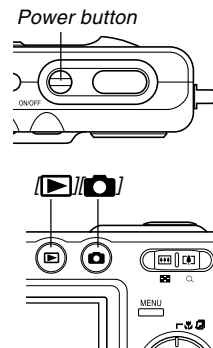

2. Press [MENU].

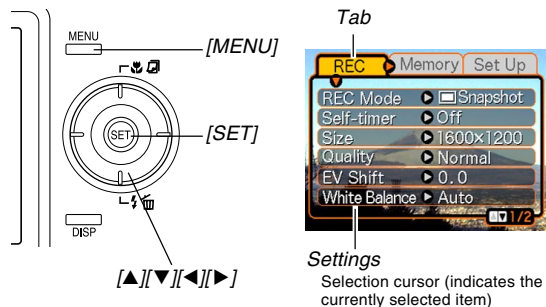

● Menu Screen Operations

| When you want to do this: | Do this: |
|--|---------------------------|
| Move between tabs | Press [◀] and [▶]. |
| Move from the tab to the settings | Press [▼]. |
| Move from the settings to the tab | Press [▲]. |
| Move between the settings | Press [▲] and [▼]. |
| Display the options available for a setting | Press [▶] or press [SET]. |
| Select an option | Press [▲] and [▼]. |
| Register an option selection and exit the menu screen | Press [SET]. |
| Register an option selection and return to the menu screen | Press [◀]. |
| Exit the menu screen | Press the [MENU] button. |

3. Press [◀] or [▶] to select the tab you want, and then press [SET] to move the selection cursor from the tab to the settings.

4. Use [▲] and [▼] to select the feature whose setting you want to configure, and then press [▶].

- Instead of pressing [▶], you could also press [SET].



Example: To select the "REC Mode" item.

5. Use [▲] and [▼] to change the currently selected setting.

6. Perform one of the following operations to apply the setting you configured.

| To do this: | Perform this key operation: |
|--|---|
| Apply the setting and exit the menu screen. | Press [SET]. |
| Apply the setting and return to feature selection in step 4. | Press [◀]. |
| Apply the setting and return to tab selection in step 3. | 1. Press [◀]. 2. Use [▲] to move back up to tab selection. |

- See "Menu Reference" on page 183 for more information about menus.

Configuring Display Language and Clock Settings

Be sure to configure the following settings before using the camera to record images.

- Display language
- Home city
- Date Style
- Date and time

Note that the current date and time settings are used by the camera to generate the date and time that are stored along with image data, etc.

►► IMPORTANT! ◀◀

- The camera's clock settings are cleared whenever power is totally cut off. This can happen if the battery goes dead while the camera is not being supplied power by the USB cradle. The clock setting screen will appear automatically the next time you turn on power after the settings are cleared. Set the date and time before using the camera.
- The current date and time settings will be cleared if the battery remains dead without being charged for about two days.
- Recording images without configuring the clock settings causes incorrect time information to be registered. Be sure to configure the clock settings before using the camera.

To configure display language and clock settings

1. Press the power button, the [CAM] (REC) or the [PLAY] (PLAY) button to turn on the camera.

2. Use [▲], [▼], [◀], and [▶] to select the language you want, and then press [SET].



日本語 : Japanese

English : English

Français : French

Deutsch : German

Español : Spanish

Italiano : Italian

Português : Portuguese

中國語 : Chinese (Complex)

中国語 : Chinese (Simplified)

한국어 : Korean

3. Use [▲], [▼], [◀], and [▶] to select the geographical area where you live, and then press [SET].



4. Use [▲] and [▼] to select the name of the city where you live, and then press [SET].



5. Use [▲] and [▼] to select the summer time (DST) setting you want, and then press [SET].

| When you want to do this: | Select this setting: |
|--|----------------------|
| Keep time using summer time (Daylight Saving Time) | On |
| Keep time using standard time | Off |

GETTING READY

6. Use [▲] and [▼] to change the date format setting, and then press [SET].

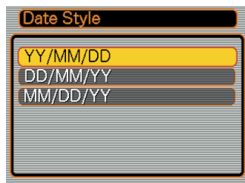

Example: December 24, 2004

| To display the date like this: | Select this format: |
|--------------------------------|---------------------|
| 04/12/24 | YY/MM/DD |
| 24/12/04 | DD/MM/YY |
| 12/24/04 | MM/DD/YY |

7. Set the current date and the time.

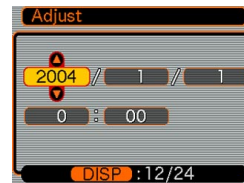

| To do this: | Do this: |
|---|--------------------|
| Change the setting at the current cursor location | Press [▲] and [▼]. |
| Move the cursor between settings | Press [◀] and [▶]. |
| Toggle between 12-hour and 24-hour timekeeping | Press [DISP]. |

8. Press [SET] to register the settings and exit the setting screen.

BASIC IMAGE RECORDING

This section describes the basic procedure for recording an image.

Recording an Image

Aiming the Camera

Use both hands to hold the camera still when shooting an image. Holding the camera with one hand increases the chance of movement, which can blur your images.

- Horizontal

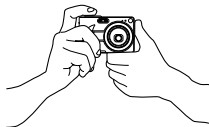

Hold the camera still in both hands, with your arms firmly against your sides.

- Vertical



When holding the camera vertically, make sure that the flash is above the lens. Hold the camera still with both hands.

IMPORTANT!

- Make sure your fingers or the strap does not block the flash, microphone or lens.

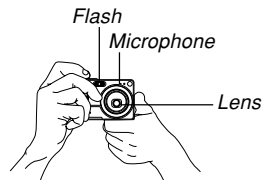

NOTE

- Your image will be blurred if you move the camera when pressing the shutter release button. Press the shutter release button carefully, taking care that there is no camera movement. This is especially important when available lighting is low, which slows down the shutter speed.

Recording an Image

Your camera automatically adjusts shutter speed in accordance with the brightness of the subject. Images you record are stored in the camera's built-in memory, or to a memory card if you have one loaded in the camera.

- When an optionally available SD memory card or MultiMediaCard (MMC) is loaded in the camera, images are stored on the card (page 136).

1. Press the power button or the [CAM] (REC) button to turn on the camera.

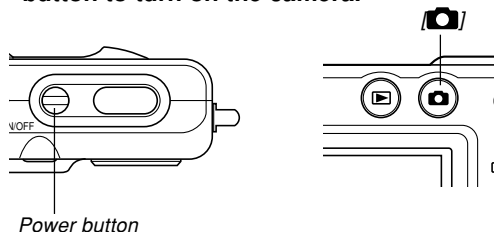

- This causes an image or a message to appear on the monitor screen.
- This enters the REC mode for image recording.
- If the camera is in the PLAY mode when it turns on, the message "There are no files" will appear if you do not have any images stored in memory yet. In addition, the [PLAY] icon will be visible at the top of the display. If this happens, press [CAM] (REC) to enter the REC mode.

2. Change the "REC Mode" setting to "Snapshot".

- Press [MENU], use the cursor keys to select the "REC" tab and then "REC Mode", press [▶], select "[CAM] Snapshot", and then press [SET]. For details, see "Using the On-screen Menus" (page 39).
- The [CAM] (Snapshot Mode) icon is displayed on the monitor screen while the Snapshot Mode is selected.
- You can also use the key customization feature to assign the mode change operation to the cursor keys, so the "REC Mode" is changed whenever you press the [◀] or [▶] key (page 89).

BASIC IMAGE RECORDING

3. Compose the image on the monitor screen so the main subject is within the focus frame.

- The focusing range of the camera in the Auto Focus mode is approximately 40cm (1.3 feet) to infinity (∞) (page 62).
- You can compose images using either the monitor screen or the optical viewfinder (page 50).
- When using the optical viewfinder to compose images, you can use the [DISP] button to turn off the monitor screen and conserve battery power.

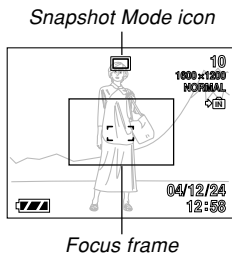

4. Press the shutter release button half way to focus the image.

- When you press the shutter release button half way, the camera's Auto Focus feature automatically focuses the image, and displays the shutter speed and aperture values.

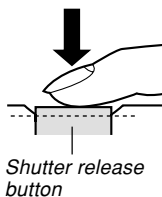

- You can tell whether the image is focused by observing the focus frame and the green operation lamp.

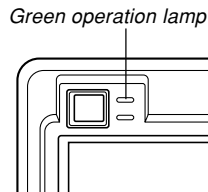

● Operation Lamp and Focus Frame Operation

| When you see this: | It means this: |
|--|----------------------------|
| Green focus frame Green operation lamp | The image is in focus. |
| Red focus frame Flashing green operation lamp | The image is not in focus. |

- Make sure you are not blocking the lens or the flash with your fingers while recording an image.

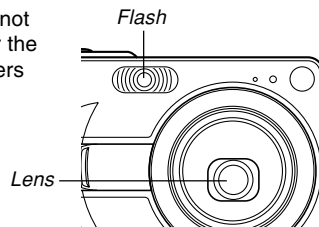

5. After making sure that the image is focused properly, press the shutter release button the rest of the way down to record.

- The number of images that can be stored in memory depends on the image size and image quality setting you are using (pages 58, 60).
- Press the shutter release button gently to avoid camera movement.

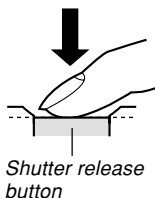

▶▶ IMPORTANT! ◀◀

- When the "REC" tab's "Auto PF" setting is turned on (page 62), the camera immediately records the image using Pan Focus (page 64) without waiting for Auto Focus to be performed when you press the shutter release all the way down without pausing. This helps to avoid missing a special moment while you wait for the camera to Auto Focus.

Recording Precautions

- Never open the battery compartment cover or place the camera onto the USB cradle while the green operation lamp is flashing. Doing so not only causes the current image to be lost, it can also corrupt images already stored in file memory and even lead to malfunction of the camera.
- Never remove the memory card while an image is being recorded to the memory card.
- Fluorescent lighting actually flickers at a frequency that cannot be detected by the human eye. When using the camera indoors under such lighting, you may experience some brightness or color problems with recorded images.
- When "Auto" is selected for the ISO sensitivity setting (page 86), the camera automatically adjusts its sensitivity in accordance with the brightness of the subject. This can cause some static noise to appear in images of relatively dark subjects.
- When recording a dimly lit subject while "Auto" is selected for the ISO sensitivity setting (page 86), the camera increases sensitivity and uses a slower shutter speed. Because of this, you need to guard against camera movement if you have flash turned off (page 53).
- If unwanted light is shining on the lens, shade the lens with your hand when recording the image.

About Auto Focus

- Auto Focus tends not to work well if the camera is moved during recording, or when recording the types of subjects listed below.
 - Solid color walls or objects with little contrast
 - Strongly backlit objects
 - Polished metal or other brightly reflective objects
 - Venetian blinds or other horizontally repeating patterns
 - Multiple images that are varying distances from the camera
 - Subjects in poorly lit areas
 - Moving subjects
- Note that a green operation lamp and focus frame do not necessarily guarantee that an image is in focus.
- If Auto Focus does not produce the results you want for some reason, try using focus lock (page 66) or manual focus (page 65).

About the REC Mode Monitor Screen

- The image shown on the monitor screen in the REC mode is a simplified image for composing purposes. The actual image is recorded in accordance with the image quality setting currently selected on your camera. The image saved in file memory has much better resolution and detail than the REC mode monitor screen image.
- Certain levels of subject brightness can cause the response of the REC mode monitor screen to slow down, which causes some static noise in the monitor screen image.

Using the Optical Viewfinder

You can conserve battery power by turning off the camera's monitor screen (page 25) and using the optical viewfinder to compose images.

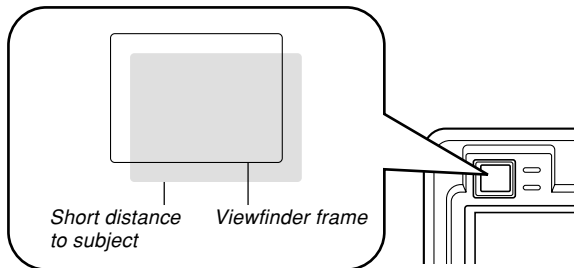

►► IMPORTANT! ◀◀

- The frame that is visible inside of the viewfinder indicates the image recorded at a distance of about one meter (3.3'). When the subject is closer than one meter, the recorded image will be different from what you see inside the viewfinder frame.
- Since the monitor screen shows exactly what will be recorded, always use it for composing your images in the Macro and Manual Focus modes.

Using Zoom

Your camera is equipped with two types of zoom: optical zoom and digital zoom.

Optical Zoom

The range of the optical zoom factor is shown below.

Optical Zoom Factor Range: 1X to 3X

1. In the REC mode, press the zoom button to change the zoom factor.

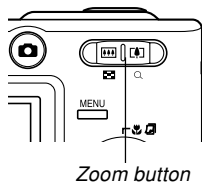

| To do this: | Press this side of the zoom button: |
|-------------|-------------------------------------|
| Zoom out | (Wide Angle) |
| Zoom in | (Telephoto) |

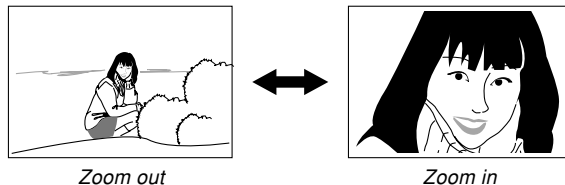

2. Compose the image, and then press the shutter release button.

NOTES

- The optical zoom factor also affects the lens aperture.
- Use of a tripod is recommended to protect against hand movement when using the telephoto setting (zoom in).

Digital Zoom

Digital zoom is activated after you reach the maximum optical zoom factor (3X). It enlarges the part of the image at the center of the image screen. The range of the digital zoom factor is shown below.

Digital Zoom Factor Range: 3X to 12X
(in combination with optical zoom)

1. In the REC mode, press [MENU].
2. Use [◀] and [▶] to select the “REC” tab.
3. Use [▲] and [▼] to select “Digital Zoom”, and then press [▶].
4. Select “On”, and then press [SET].
 - Selecting “Off” disables digital zoom.

5. Hold down the [⏏] (Telephoto) zoom button to increase the optical zoom factor.

- When the digital zoom factor reaches its maximum value (3X), it stops momentarily. Keep the [⏏] (Telephoto) zoom button depressed and zoom will switch over to digital zoom automatically.
- Switching to digital zoom causes the zoom indicator to appear on the monitor screen. The zoom indicator shows the current approximate zoom factor.

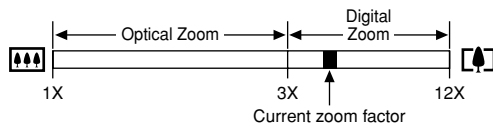
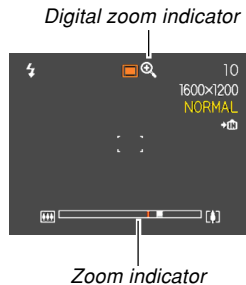

6. Compose the image, and then press the shutter release button.

▶▶ IMPORTANT! ◀◀

- Digital zoom is disabled whenever the monitor screen is turned off (page 25).
- Using digital zoom can cause degradation of the recorded image.

Using the Flash

Perform the following steps to select the flash mode you want to use.

1. In the REC mode, press [MENU].

2. Press [▼] (⚡ 🗑️) to select the flash mode.

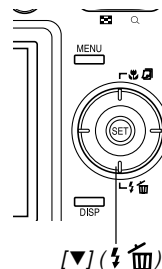

- Each press of [▼] (⚡ 🗑️) cycles through the flash mode settings shown below on the monitor screen.

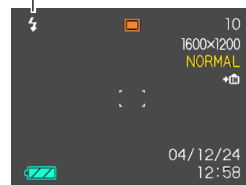

Flash mode indicator



BASIC IMAGE RECORDING

| To do this: | Select this setting: |
|---|---|
| Have the flash fire automatically when required (Auto Flash) | None |
| Turn off the flash (Flash Off) |  |
| Always fire the flash (Flash On) |  |
| Fire a pre-flash followed by image recording with flash, reducing the chance of red-eye in the image (Red-eye reduction) In this case, the flash fires automatically when required |  |

3. Record the image.

▶▶ IMPORTANT! ◀◀

- The flash unit of this camera fires a number of times when you record an image. The initial flashes are pre-flashes, which the camera uses to obtain information that it uses for exposure settings. The final flash is for recording. Make sure that you keep the camera still until the shutter releases.
- Image recording may not be performed if you press the shutter release button while the red operation lamp is flashing.

■ About Red-eye Reduction

Using the flash to record at night or in a dimly lit room can cause red spots inside the eyes of people who are in the image. This is caused when the light from the flash reflects off of the retina of the eye. When red-eye reduction is selected as the flash mode, the camera performs two pre-flash operations, one designed to cause the irises in the eyes of any people in the image to close, and one for the Auto Focus operation. This is followed by another flash operation for actual recording of the image.

▶▶ IMPORTANT! ◀◀

Note the following important points when using red-eye reduction.

- Red-eye reduction does not work unless the people in the image are looking directly at the camera during the pre-flash. Before pressing the shutter release button, call out to the subjects so they all look at the camera while the pre-flash operation is performed.
- Red-eye reduction may not work very well if the subjects are located far away from the camera.

Flash Unit Status

You can find out the current flash unit status by pressing the shutter release button half way and checking the monitor screen and red operation lamp.

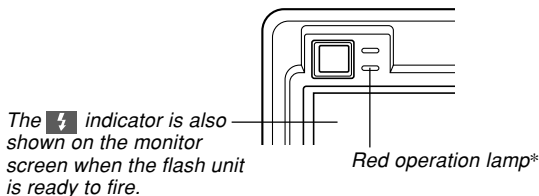





* Red operation lamp

| When the red operation lamp is this: | It means this: |
|--------------------------------------|-----------------------------|
| Flashing | Flash unit is charging |
| Lit | Flash unit is ready to fire |

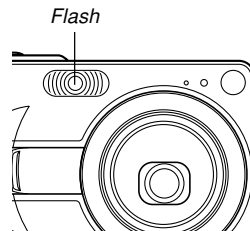
Flash Precautions

Take care that your fingers do not block the flash when you hold the camera. Covering the flash with your finger can greatly reduce its effectiveness.



- You may not be able to achieve the desired results using a flash if the subject is too close or too far away.
- The flash takes anywhere from a few seconds to as long as 10 seconds to attain full charge after being fired. The actual time required depends on the battery level, temperature, and other conditions.
- The flash does not fire in the Movie mode. This is indicated by  (Flash Off) on the monitor screen.
- The flash unit may not be able to charge when battery power is low. Low battery power is indicated by  (Flash Off) on the monitor screen, and when the flash fails to fire properly resulting in poor image exposure. When these symptoms occur, charge the camera's battery as soon as possible.
- When the red-eye reduction mode  is selected, flash intensity is adjusted automatically in accordance with the exposure. The flash may not fire at all when the subject is brightly lit.

- Using flash in combination with another light source (daylight, fluorescent light, etc.) can result in abnormal image colors.

Using the Self-timer

The self-timer lets you select either a 2-second or 10-second delay of the shutter release after you press the shutter release button. A Triple Self-timer feature lets you perform three consecutive self-timer operations to record three images.

- 1. In the REC mode, press [MENU].**
- 2. Use [◀] and [▶] to select the “REC” tab.**
- 3. Use [▲] and [▼] to select “Self-timer”, and then press [▶].**
- 4. Use [▲] and [▼] to select the self-timer time you want to use, and then press [SET].**
 - Selecting “Off” in step 4 disables the self-timer.

BASIC IMAGE RECORDING

| To do this: | Select this setting: |
|--------------------------------|----------------------|
| Specify a 10-second self-timer | 10 sec |
| Specify a 2-second self-timer | 2 sec |
| Specify Triple Self-timer | X3 |
| Disable the self-timer | Off |

- With the Triple Self-timer, the camera records a series of three images in the sequence described below.
 1. The camera performs a 10-second countdown and then records the first image.
 2. The camera prepares to record the next image. The amount of time required for preparation depends on the camera's current "Size" and "Quality" settings, the type of memory (built-in or card) you are using for image storage, and whether or not the flash is charging.
 3. After preparation is complete, the indicator "1sec" appears on the monitor screen, and another image is recorded one second later.
 4. Steps 2 and 3 are repeated once more to record the third image.

5. Record the image.

- When you press the shutter release button, the self-timer lamp flashes and the shutter releases after the self-timer reaches the end of its countdown.
- You can interrupt an ongoing self-timer countdown by pressing the shutter release button while the self-timer lamp is flashing.

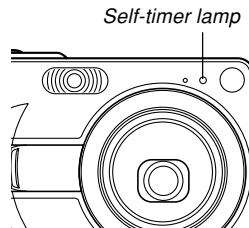

NOTE

- The "2 sec" self-timer setting is best when shooting with a slow shutter speed, because it helps to avoid blurring of images due to hand movement.

Specifying Image Size and Quality

You can specify the image size and image quality to suit the type of image you are recording.

To specify the image size

“Image size” is the size of the image, expressed as the number of vertical and horizontal pixels. A “pixel” is one of the many tiny dots that make up the image. More pixels provide finer detail when an image is printed, but a higher pixel count also causes the image’s file size to be larger. You can select an image size to suit your needs for greater detail or smaller file size.

1. In the REC mode, press [MENU].
2. Use [◀] and [▶] to select the “REC” tab.
3. Use [▲] and [▼] to select “Size”, and then press [▶].

4. Use [▲] and [▼] to select the setting you want, and then press [SET].

- EX-Z30

| | | |
|-------------------|---|--------------------------|
| 2048 x 1536 | : | 2048 x 1536 pixels |
| 2048 x 1360 (3:2) | : | 2048 x 1360 (3:2) pixels |
| 1600 x 1200 | : | 1600 x 1200 pixels |
| 1280 x 960 | : | 1280 x 960 pixels |
| 640 x 480 | : | 640 x 480 pixels |
- EX-Z40

| | | |
|-------------------|---|--------------------------|
| 2304 x 1728 | : | 2304 x 1728 pixels |
| 2304 x 1536 (3:2) | : | 2304 x 1536 (3:2) pixels |
| 1600 x 1200 | : | 1600 x 1200 pixels |
| 1280 x 960 | : | 1280 x 960 pixels |
| 640 x 480 | : | 640 x 480 pixels |

BASIC IMAGE RECORDING

»» NOTES ««

- The following are guidelines for selecting the image size.

■EX-Z30

| When you want to do this:* | Use this setting:* | |
|--|--------------------|---|
| Print the image on paper up to 260 x 195mm (10.2 x 7.7 inches) | 2048 x 1536 | Larger ↑ ↓ Smaller |
| Print the image on paper up to 260 x 173mm (10.2 x 6.8 inches) | 2048 x 1360(3:2) | |
| Print the image on paper up to 203 x 152mm (8 x 6 inches) | 1600 x 1200 | |
| Print the image on paper up to 163 x 122mm (6.4 x 4.8 inches) | 1280 x 960 | |
| Print the image on paper up to 81 x 61mm (3.2 x 2.4 inches), or attach the image to e-mail | 640 x 480 | Smaller |

■EX-Z40

| When you want to do this:* | Use this setting:* | |
|---|--------------------|---|
| Print the image on paper approximately 293 x 219mm (11.5 x 8.6 inches) | 2304 x 1728 | Larger ↑ ↓ Smaller |
| Print the image on paper up to 293 x 195mm (11.5 x 7.7 inches) | 2304 x 1536(3:2) | |
| Print the image on paper up to 203 x 152mm (8 x 6 inches) | 1600 x 1200 | |
| Print the image on paper up to 163 x 122mm (6.4 x 4.8 inches) | 1280 x 960 | |
| Print the image on paper up to 81 x 61mm (3.2 x 2.4 inches) or attach the image to e-mail | 640 x 480 | Smaller |

* The sizes indicated by the settings are rough approximates only.

- The above paper sizes are all approximate values when printing at a resolution of 200 dpi (dots per inch). Use a larger setting when you want to print at a higher resolution or when you plan to produce a larger size print.
- Selecting the “2048 x 1360 (3:2)” (EX-Z30) or “2304 x 1536 (3:2)” (EX-Z40) image size records images with a 3:2 (vertical : horizontal) aspect ratio, which is optimal for printing on paper with an aspect ratio of 3:2.

To specify image quality

Compressing an image before storage can cause a deterioration of its quality. The more an image is compressed, the greater the loss of quality. The image quality setting specifies the compression ratio used when an image is stored in memory. You can select an image quality setting to suit your needs for higher quality or smaller file size.

1. In the REC mode, press [MENU].
2. Use [◀] and [▶] to select the “REC” tab.
3. Use [▲] and [▼] to select “Quality”, and then press [▶].
4. Use [▲] and [▼] to select the setting you want, and then press [SET].

| To get this: | Select this setting: |
|--|----------------------|
| Very high quality, but large file size | Fine |
| Normal quality | Normal |
| Small file size, but low quality | Economy |

NOTE

- The following are guidelines for selecting image quality.

| To get this: | Select this setting: | |
|--|----------------------|----------------|
| High image quality, less memory capacity | Fine | Higher Quality |
| Normal image quality and memory capacity | Normal | ↑ ↓ |
| High memory capacity, less image quality | Economy | Lower Quality |

IMPORTANT!

- Actual file size depends on the type of image you record. This means that the remaining image capacity noted on the monitor screen may not be exactly accurate (pages 22 and 194).

OTHER RECORDING FUNCTIONS

This section describes other powerful features and functions that are available for recording.

Selecting the Focus Mode

You can select one of five different focus modes: Auto Focus, Macro, Pan Focus, Infinity, and Manual.

1. In the REC mode, press [▲] (🌸 📷).

- Each press of [▲] (🌸 📷) cycles through the focus mode settings in the sequence shown below.

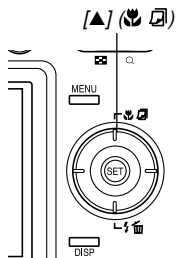

Focus mode indicator

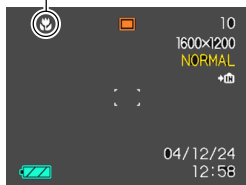

| To set up the camera to do this: | Select this setting: |
|------------------------------------|----------------------|
| Focus automatically (Auto Focus) | None |
| Perform close-up focus (Macro) | 🌸 |
| Fix the focal distance (Pan Focus) | PF |
| Perform infinity focus (Infinity) | ∞ |
| Focus manually (Manual Focus) | MF |

Using Auto Focus

As its name suggests, Auto Focus focuses the image automatically. The automatic focus operation starts when you press the shutter release button down half way. The following is the Auto Focus range.

Range: Approximately 40cm to ∞ (1.3' to ∞)

1. Keep pressing [▲] (👉 📷) until there is no focus mode indicator on the display.
2. Compose the image so the main subject is within the focus frame, and then press the shutter release button half way.

- You can tell whether the image is focused by observing the focus frame and the green operation lamp.

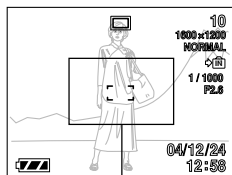

Focus frame

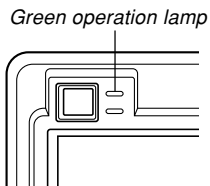

Green operation lamp

| When you see this: | It means this: |
|--|----------------------------|
| Green focus frame Green operation lamp | The image is focused. |
| Red focus frame Flashing green operation lamp | The image is not in focus. |

3. Press the shutter release button the rest of the way to record the image.

■ Auto Pan Focus

When you press the shutter release button all the way down in the Auto Focus mode without pausing, the camera immediately records the image using Pan Focus (page 64) without waiting for Auto Focus to be performed. This helps to avoid missing a special moment while you wait for the camera to Auto Focus.

1. In the REC mode, press [MENU].
2. Select the “REC” tab, select “Auto PF”, and then press [▶].
3. Select the setting you want and then press [SET].

OTHER RECORDING FUNCTIONS

| To do this: | Select this setting: |
|-------------------------|----------------------|
| Turn on Auto Pan Focus | On |
| Turn off Auto Pan Focus | Off |

■ Specifying the Auto Focus Area

You can use the following procedure to change the Auto Focus area used in the Auto Focus Mode and the Macro Mode. Note that the configuration of the focus frame changes in accordance with the Auto Focus area you select.

1. In the REC mode, press [MENU].
2. On the “REC” tab, select “AF Area”, and then press [▶].
3. Select the Auto Focus area you want, and then press [SET].

| For this type of Auto Focus area: | Select this: |
|---|--------------|
| Very limited range in the center of the screen • This setting works well with focus lock (page 66). | Spot |
| Automatic selection of the focus area where the subject closest to the camera is located • With this setting, a wide focus frame, which contains seven focus points, appears on the monitor screen first. When you press the shutter release button half way, the camera automatically selects the focus point where the subject closest to the camera is located, and a focus frame appears at that point. • This setting works well for group photos. | Multi |

• Spot

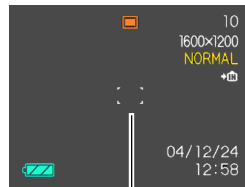

Focus frame

• Multi

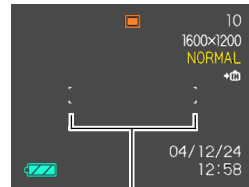

Focus frame

Using the Macro Mode

The Macro mode lets you focus automatically on close up subjects. The automatic focus operation starts when you press the shutter release button down half way. The following is the focus range in the Macro mode.

Range: Approximately 6cm to 50cm (2.4" to 19.7")

1. Keep pressing [▲] (👉📷) until the focus mode indicator shows "👉".

2. Record the image.

- The focus and image recording operations are identical to those in the Auto Focus mode.
- You can tell whether the image is focused by observing the focus frame and the green operation lamp. The indications of the focus frame and green operation lamp are the same as those in the Auto Focus mode.

▶▶ IMPORTANT! ◀◀

- In the Macro mode, the optical zoom range is 1X to 1.8X.

Using the Pan Focus Mode

Normally, your camera performs Auto Focus to ensure that your images are always in focus. With Pan Focus, focus is fixed for a specific focal distance, and images are recorded without Auto Focus. The focus range depends on the zoom setting, the amount of light available when recording, and other recording conditions.

1. Keep pressing [▲] (👉📷) until the focus mode indicator shows "PF".

2. Press the shutter release button all the way down.

▶▶ NOTE ◀◀

- If you press the shutter release button half way, the focus distance will appear on the monitor screen.



Focus range

▶▶ IMPORTANT! ◀◀

- When using the flash, it is recommended that you have the zoom set to wide angle.

Using the Infinity Mode

The Infinity mode fixes focus at infinity (∞). Use this mode when recording scenery and other faraway images.

1. Keep pressing [**▲**] (**🌿** **📷**) until the focus mode indicator shows “ ∞ ”.
2. Record the image.

Using Manual Focus

With the Manual Focus mode, you can adjust the focus of an image manually. The following shows focus ranges in the Macro mode for two optical zoom factors.

| Optical Zoom Factor | Approximate Focus Range |
|---------------------|--------------------------------------|
| 1X | 6cm (2.4") to infinity (∞) |
| 3X | 18cm (7.1") to infinity (∞) |

1. Keep pressing [**▲**] (**🌿** **📷**) until the focus mode indicator shows “MF”.

- At this point, a boundary also appears on the display, indicating the part of the image that will be used for manual focus.

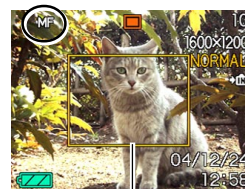

Boundary

OTHER RECORDING FUNCTIONS

2. While watching the image on the monitor screen, use [◀] and [▶] to focus.

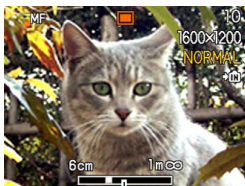

Manual focus position

| To do this: | Do this: |
|--------------------------|------------|
| Focus in on the subject | Press [◀]. |
| Focus out on the subject | Press [▶]. |

- Pressing [◀] or [▶] causes the area inside of the boundary displayed in step 1 to fill the monitor screen momentarily to aid in focus. The normal image reappears a short while later.

3. Press the shutter release button to record the image.

▶▶ IMPORTANT! ◀◀

- In the Manual Focus mode, the [◀] and [▶] keys adjust focus, even if you used key customization to assign other functions to them (page 89).

Using Focus Lock

Focus lock is a technique you can use to focus on a subject that is not located within the focus frame when you record an image. You can use focus lock in the Auto Focus mode and the Macro mode (📷).

1. Using the monitor screen, compose the image so the main subject is within the focus frame, and then press the shutter release button half way.

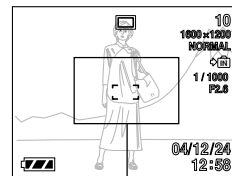

Focus frame

- You can tell whether the image is focused by observing the focus frame and the green operation lamp. The indications of the focus frame and green operation lamp are the same as those in the Auto Focus mode.

OTHER RECORDING FUNCTIONS

2. Keeping the shutter release button half way down, re-compose the image as you like.

- This locks the focus on the subject that is currently within the focus frame.

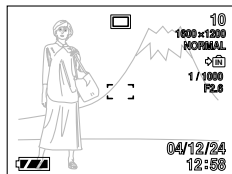

3. When the image is composed the way you want, press the shutter release button the rest of the way to record it.

- The focus and image recording operations are identical to those in the Auto Focus mode.

NOTE

- Locking the focus also locks the exposure.

Exposure Compensation (EV Shift)

Exposure compensation lets you change the exposure setting (EV value) manually to adjust for the lighting of your subject. This feature helps to achieve better results when recording a backlit subject, a strongly lit subject indoors, or a subject that is against a dark background.

EV Shift Range: -2.0EV to $+2.0\text{EV}$

Steps: $1/3\text{EV}$

1. In the REC mode, press [MENU].

2. Select the “REC” tab, select “EV Shift”, and then press [▶].



Exposure compensation value

OTHER RECORDING FUNCTIONS

3. Use [▲] and [▼] to change the exposure compensation value, and then press [SET].

- Pressing [SET] registers the displayed value.



EV value

Up : Increases the EV value. A higher EV value is best used for light-colored subjects and backlight subjects.

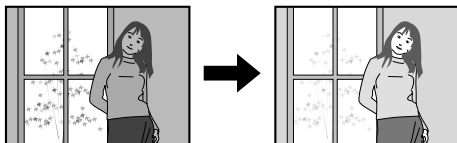

Down : Decreases the EV value. A lower EV value is best for dark-color subjects and for shooting outdoors on a clear day.

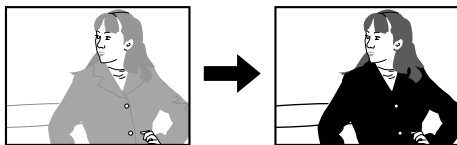

- To cancel EV Shift, adjust the value until it becomes 0.0.

4. Record the image.

IMPORTANT!

- When shooting under very dark or very bright conditions, you may not be able to obtain satisfactory results even after performing exposure compensation.

NOTES

- Performing an EV shift operation causes the metering mode to switch automatically to center weighted metering. Returning the EV shift value to 0.0 causes the metering mode to change back to multi-pattern metering.
- You can use key customization (page 89) to configure the camera to perform exposure compensation whenever you press [◀] or [▶] while in the REC mode.

Adjusting White Balance

The wavelengths of the light produced by various light sources (sunlight, light bulb, etc.) can affect the color of a subject when it is recorded. White balance lets you make adjustments to compensate for different lighting types, so the colors of an image appear more natural.

1. In the REC mode, press [MENU].

2. Select the “REC” tab, select “White Balance”, and then press [▶].

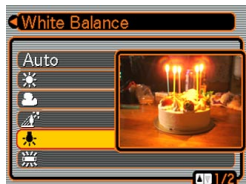

3. Use [▲] and [▼] to select the setting you want, and then press [SET].

| When shooting under these conditions: | Select this setting: |
|---|----------------------|
| Normal conditions | Auto |
| Outdoor daylight | |
| Outdoor overcast sky | |
| Shade | |
| Incandescent light bulb (reddish tinge) | |
| Fluorescent light (greenish tinge) | |
| Difficult lighting that requires manual control (See “Adjusting White Balance Manually”.) | Manual |

NOTES

- Selecting “Manual” changes white balance to the settings achieved the last time a manual white balance operation was performed.
- You can use the key customization feature (page 89) to configure the camera so the white balance setting changes whenever you press [◀] or [▶] while in the REC mode.

Adjusting White Balance Manually

Under some light sources, automatic white balance under the “Auto” setting can take a long time to complete. Also, the auto white balance range (color temperature range) is limited. Manual white balance helps to ensure that colors are recorded correctly for a particular light source. Note that you must perform manual white balance under the same conditions you will be shooting under. You must also have a white piece of paper or other similar object on hand in order to perform manual white balance.

1. In the REC mode, press [MENU].
2. Select the “REC” tab, select “White Balance”, and then press [▶].
3. Use [▲] and [▼] to select “Manual”.

- This causes the object you last used to adjust manual white balance to appear on the monitor screen.



4. Point the camera at a white piece of paper or similar object under the lighting conditions for which you want to set the white balance, and then press the shutter release button.

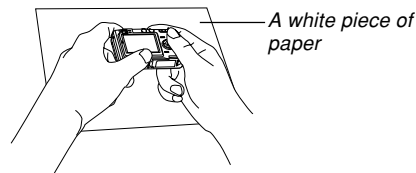

- This starts the white balance adjustment procedure. The message “Complete” appears on the monitor screen after white balance adjustment is complete.
- Dim lighting or pointing the camera at a dark colored object while performing manual white balance adjustment can cause the procedure to take a long time to complete.

5. Press [SET].

- This registers the white balance settings and returns to the REC mode.

Using the BESTSHOT Mode

Selecting one of the 21 BESTSHOT scenes automatically sets up the camera for recording a similar type of image.

■ Example Sample Scene

- Portrait



- Scenery



- Night Scene



- Night Scene Portrait



1. In the REC mode, press [MENU].
2. Select the “REC” tab, select “REC Mode”, and then press [▶].
3. Use [▲] and [▼] to select “**BS** BESTSHOT”, and then press [SET].
 - This enters the BESTSHOT mode and displays a sample scene.
4. Use [◀] and [▶] to select the sample scene you want, and then press [SET].
5. Record the image.

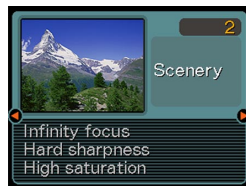

OTHER RECORDING FUNCTIONS

▶▶ IMPORTANT! ◀◀

- Sample scene number 4 is Coupling Shot scene (page 75). Sample scene number 5 is a Pre-shot scene (page 77).
- BESTSHOT scenes were not recorded using this camera. They are provided as samples only.
- Images recorded using a BESTSHOT scene may not produce the results you expected due to shooting conditions and other factors.
- After selecting a BESTSHOT scene, you can change to a different one by pressing [SET] and then using [◀] and [▶] to scroll through available scenes. When the one you want is displayed, press [SET].
- You can change the camera settings that are made when you select a BESTSHOT scene. Note, however, that the BESTSHOT settings revert to their defaults when you select another BESTSHOT scene, change the recording mode, or turn off the camera.
- Noise reduction processing is performed automatically when you are recording a night scene, fireworks, or other image that requires slow shutter speeds. Because of this, it takes longer to record images at lower shutter speeds. Make sure that you do not perform any camera button operations until the image recording operation is complete.

▶▶ NOTES ◀◀

- You can use the key customization feature (page 89) to configure the camera to enter the BESTSHOT mode whenever you press [◀] or [▶] while in the REC mode.
- Operation guidance and the currently selected BESTSHOT scene appear on the display for about two seconds after you enter the BESTSHOT mode this way, or if the camera is in the BESTSHOT mode when you turn it on.



Creating Your Own BESTSHOT Setup

You can use the procedure below to save the setup of an image you recorded for later recall when you need it again. Recalling a setup you save automatically sets up the camera accordingly.

1. In the REC mode, press [MENU].
2. Select the “REC” tab, select “REC Mode”, and then press [▶].
3. Use [▲] and [▼] to select “**BS** BESTSHOT”, and then press [SET].
 - This enters the BESTSHOT mode and displays a sample scene.
4. Use [◀] and [▶] to display “Register User Scene”.
5. Press [SET].



6. Use [◀] and [▶] to display the image whose setup you want to register as a BESTSHOT scene.



7. Use [▲] and [▼] to select “Save”, and then press [SET].

- This registers the setup.
- Now you can use the procedure on page 71 to select your user setup for recording.

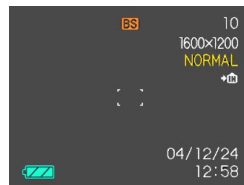

▶▶ IMPORTANT! ◀◀

- BESTSHOT user setups are located in the camera's built-in memory after the built-in sample scenes.
- When a BESTSHOT user setup is recalled, the monitor screen in step 4 of the procedure on page 71 displays the text "Recall User Scene".
- Note that formatting the built-in memory (page 135) deletes all BESTSHOT user setups.

▶▶ NOTES ◀◀

- The following are the settings that are included in a BESTSHOT user setup: focus mode, EV shift value, white balance mode, flash mode, and ISO sensitivity.
- Note that images recorded with this camera only can be used to create a BESTSHOT user setup.
- You can have up to 999 BESTSHOT user setups in the camera's built-in memory at one time.
- You can check the current setup of a scene by displaying the various setting menus.
- When you register a BESTSHOT user setup, it is automatically assigned a file name using one of the formats shown below, depending on your camera model.
EX-Z30: UEZ30nnn.JPE (n = 0 to 9)
EX-Z40: UEZ40nnn.JPE (n = 0 to 9)

■ To delete a BESTSHOT user setup

1. In the REC mode, press [MENU].
2. Select the "REC" tab, select "REC Mode", and then press [▶].
3. Use [▲] and [▼] to select "BS BESTSHOT", and then press [SET].
 - This enters the BESTSHOT mode and displays a sample scene.
4. Use [◀] and [▶] to display the user setup you want to delete.
5. Press [▼] (⚡ ) to delete the user setup.
 - You can also delete a user setup by using your computer to delete its file in the "SCENE" folder in the camera's built-in memory (page 163).

Combining Shots of Two People into a Single Image (Coupling Shot)

The Coupling Shot mode lets you record images of two people and combine them into a single image. This makes it possible for you to include yourself in group images, even when there is no one else around to record the image for you. Coupling Shot is available in the BESTSHOT mode (page 71).

- First Image



This is the part of the image that does not include the person who is recording the first image.





- Second Image

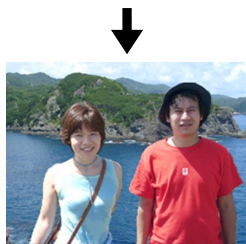

Making sure that the background of the image is aligned correctly, record the image of the person who recorded the first image.

- Combined Images



1. In the REC mode, press [MENU].
2. Select the “REC” tab, select “REC Mode”, and then press [▶].
3. Use [▲] and [▼] to select “ BESTSHOT”, and then press [SET].
4. Use [◀] and [▶] to select “Coupling Shot”, and then press [SET].

OTHER RECORDING FUNCTIONS

5. Align the focus frame on the monitor screen with the subject you want on the left side of the image.

- While “Coupling Shot” is selected, the “AF Area” (page 63) setting automatically becomes “Spot”.

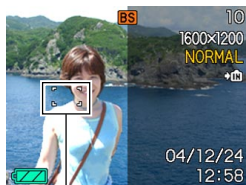

Focus frame

6. Press the shutter release button to record the left side of the image.

- The focus, exposure, white balance, zoom, and flash settings are fixed for this type of image.

7. Next, align the focus frame with the subject you want in the right side of the image, taking care to align the actual background with the semi-transparent image of the background of the first image.



Semi-transparent image

- Pressing [MENU] any time after step 5 of the above procedure cancels the first image and returns to step 5.

8. When everything is aligned correctly, record the right side of the image.

▶▶ IMPORTANT! ◀◀

- Coupling Shot temporarily uses file memory to store data. You may get an error during Coupling Shot recording if there is not enough file memory available to store the required data. If this happens, delete images you no longer need and try again.

Recording a Subject onto an Existing Background Image (Pre-shot)

Pre-shot helps you get the background you want, even if you need to ask someone else to record the image for you. Basically, Pre-shot is a two-step process.

1. You compose the background you want and press the shutter release button, which causes a semi-transparent image of the background to remain on the monitor screen.
2. Ask someone else to record a shot of you against your original background, telling them to compose the image by using the semi-transparent monitor screen image as a guide.
 - The camera stores the image produced by step 2 only.
 - Depending on how the image is actually composed in step 2, its background may not be exactly the same as the one you composed in step 1.

Note that Pre-shot is available in the BESTSHOT mode only (page 71).

OTHER RECORDING FUNCTIONS

- Freeze the background on the monitor screen.



- Record the image, using the background on the monitor screen as a guide.



- This records the image.



1. In the REC mode, press [MENU].
2. Select the “REC” tab, select “REC Mode”, and then press [▶].
3. Use [▲] and [▼] to select “[BS] BESTSHOT”, and then press [SET].
4. Use [◀] and [▶] to select “Pre-shot”, and then press [SET].
5. Freeze the background on the monitor screen.
 - Though a semi-transparent image of the background appears on the monitor screen in step 6, the background image is not saved in memory at this time.
 - The focus, exposure, white balance, zoom, and flash settings are fixed for this type of image.

OTHER RECORDING FUNCTIONS

6. Next, align the focus frame with the subject, composing the subject with the semi-transparent background shown on the monitor screen.



Semi-transparent image

- Pressing [MENU] any time after step 5 of the above procedure cancels the background image and returns to step 5.

7. When everything is aligned correctly, record the image.

- This records the image composed on the monitor screen in step 6. The reference background image is not recorded.

Using the Movie Mode

You can record movies with audio. A single movie can be as long as available memory capacity allows.

- File Format: AVI
AVI format conforms to the Motion JPEG format promoted by the Open DML Group.
- Image Size: 320 x 240 pixels
- Movie File Size: Approximately 300KB/second.
- Maximum Movie Length
 - One Movie:
As long as available memory capacity allows

1. In the REC mode, press [MENU].

2. Select the “REC” tab, select “REC Mode”, and then press [▶].

OTHER RECORDING FUNCTIONS

3. Use [▲] and [▼] to select “ Movie”, and then press [SET].



4. Point the camera at the subject and then press the shutter release button.

- Movie recording continues as long as remaining memory capacity allows, or until you stop it by pressing the shutter release button again.
- Starting a movie record operation causes optical zoom to be disabled. Only digital zoom is available while a movie record operation is in progress. If you want to use optical zoom to record a movie, perform the zoom operation before starting the record operation.

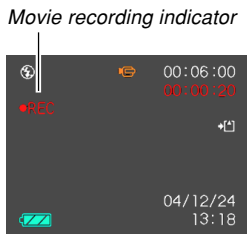

- The remaining recording time value counts down on the monitor screen as you record.
- The focus mode automatically changes to Pan Focus (page 64) when you enter the Movie mode, regardless of the mode memory's (page 90) Focus setting. You can, however, change to another focus mode before starting a recording.



5. When movie recording is complete, the movie file is stored in file memory.

▶▶ IMPORTANT! ◀◀

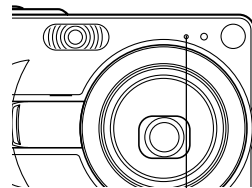
- The flash does not fire in the Movie mode.
- This camera also records audio. Note the following points when recording a movie.
 - Take care that you do not block the microphone with your fingers.
 - Good recording results are not possible when the camera is too far from the subject.
 - Operating camera buttons during recording can cause button noise to be included in the audio.
 - Movie audio is recorded in monaural.



Microphone

- The camera automatically switches to the Pan Focus mode (PF) (page 64) whenever you enter the Movie Mode.
- The camera focuses automatically whenever you have Auto Focus (page 62) or Macro (M) selected as the focus mode. Note that the confirmation tone that sounds during the Auto Focus operation will be recorded in the audio. If you do not want confirmation tones in your audio, keep Pan Focus (PF) as the focus mode, or select Manual Focus (MF) and manually focus the image before starting your recording.
- Auto Focus is not performed in the case of the Pan Focus (PF), Manual Focus (MF) and Infinity (∞) focus modes, and so no confirmation tone sounds. In the case of the Manual Focus mode, you cannot adjust focus settings while recording is in progress. Be sure to make all adjustments before beginning the record operation.
- Certain types of memory cards take longer to record data, which can cause movie frames to be dropped.  and  flash on the monitor screen during recording to let you know when a frame has been dropped.

Recording Audio

Adding Audio to a Snapshot

You can add audio to a snapshot after you record it.

- **Image Format: JPEG**
JPEG is an image format that provides efficient data compression.
The file extension of a JPEG file is “.JPG”.
- **Audio Format: WAVE/ADPCM recording format**
This is the Windows standard format for audio recording.
The file extension of a WAVE/ADPCM file is “.WAV”.
- **Recording Time:**
Up to about 30 seconds per image
- **Audio File Size:**
Approximately 120KB (30-second recording of approximately 4KB per second)

OTHER RECORDING FUNCTIONS

1. In the REC mode, press [MENU].
2. Select the “REC” tab, select “REC Mode”, and then press [▶].
3. Use [▲] and [▼] to select “[📷] ([📷]+🎤)” and then press [SET].
 - This enters the Snapshot Audio Mode.

4. Press the shutter release button to record the image.

- After the image is recorded, the camera enters audio recording standby, with the image you just recorded on the monitor screen.
- You can cancel audio recording standby by pressing [MENU].

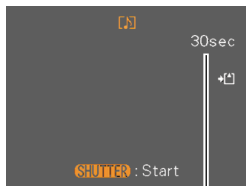

Remaining recording time

5. Press the shutter release button to start audio recording.
 - The green operation lamp flashes as recording is performed.
 - Even if you have the monitor screen turned off (page 25), the monitor screen turns on while you are adding audio to a snapshot.
6. Recording stops after about 30 seconds or when you press the shutter release button.

Recording Your Voice

The Voice Recording Mode provides quick and easy recording of your voice.

- **Audio Format:** WAVE/ADPCM recording format
This is the Windows standard format for audio recording. The file extension of a WAVE/ADPCM file is “.WAV”.
- **Recording Time:**
Approximately 40 minutes with built-in memory
- **Audio File Size:**
Approximately 120KB (30-second recording of approximately 4KB per second)

1. In the REC mode, press [MENU].
2. Select the “REC” tab, select “REC Mode”, and then press [▶].
3. Use [▲] and [▼] to select “Voice”, and then press [SET].

- This enters the Voice Recording Mode.

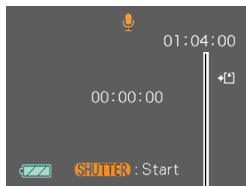

Remaining recording time

4. Press the shutter release button to start voice recording.

- The remaining recording time value counts down on the monitor screen and the green operation lamp flashes as recording is performed.
- Pressing the [DISP] button during voice recording turns off the monitor screen.
- You can insert index marks while recording by pressing [SET]. See page 111 for information about jumping to an index mark during playback.

5. Recording stops when you press the shutter release button, when memory becomes full, or when the battery goes dead.

NOTE

- Holding down [DISP] as you press the power button or [CAM] (REC) enters the Voice Recording Mode without extending the lens.

■ Audio Recording Precautions

- Keep the microphone on the front of the camera pointed at the subject.
- Take care that you do not block the microphone with your fingers.

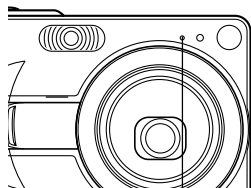

Microphone

- Good recording results are not possible when the camera is too far from the subject.
- Operating camera buttons during recording can cause button noise to be included in the audio.
- Pressing the power button or pressing [▶] (PLAY) stops recording and stores any audio recorded up to that point.
- You can also perform “after-recording” to add audio to a snapshot after recording it, and also change the audio recorded for an image. See page 109 for more information.

Using the Histogram

You can use the [DISP] button to display a histogram on the monitor screen. The histogram lets you check exposure conditions as you record images (page 25). You can also display the histogram of a recorded image in the PLAY mode.

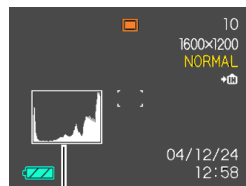

Histogram

A histogram is a graph that represents the lightness of an image in terms of the number of pixels. The vertical axis indicates the number of pixels, while the horizontal axis indicates lightness. You can use the histogram to determine whether an image includes the shadowing (left side), mid tones (center), and highlighting (right) required to bring out sufficient image detail. If the histogram appears too lopsided for some reason, you can use EV shift (exposure compensation) to move it left or right in order to achieve better balance. Optimum exposure can be achieved by correcting exposure so the graph is as close to the center as possible.

OTHER RECORDING FUNCTIONS

- When the histogram is too far to the left, it means that there are too many dark pixels. This type of histogram results when the overall image is dark. A histogram that is too far to the left may result in “black out” of the dark areas of an image.

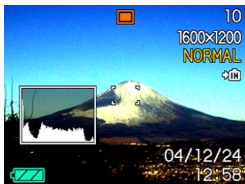

- When the histogram is too far to the right, it means that there are too many light pixels. This type of histogram results when the overall image is light. A histogram that is too far to the right may result in “white out” of the light areas of an image.

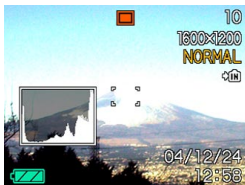

- A centered histogram indicates that there is good distribution of light pixels and dark pixels. This type of histogram results when the overall image is at optimal lightness.

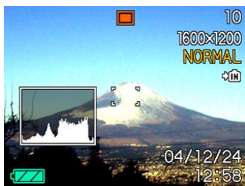

▶▶ IMPORTANT! ◀◀

- Note that the above histograms are shown for illustrative purposes only. You may not be able to achieve exactly the same shapes for particular subjects.
- A centered histogram does not necessarily guarantee optimum exposure. The recorded image may be over-exposed or under-exposed, even though its histogram is centered.
- You may not be able to achieve an optimum histogram configuration due to the limitations of EV shift.
- Use of the flash as well as certain shooting conditions can cause the histogram to indicate exposure that is different from the actual exposure of the image when it was recorded.
- This histogram does not appear when you are using Coupling Shot (page 75) or Pre-shot (Page 77).

REC Mode Camera Settings

The following are the settings you can make before recording an image using a REC mode.

- ISO sensitivity
- Grid on/off
- Image Review on/off
- L/R key setting
- Power on default settings
- Resetting the camera

NOTE

- You can also configure the settings listed below. See the referenced pages for more information.
 - Size (page 58)
 - Quality (page 60)
 - White Balance (page 69)
 - Digital Zoom (page 52)
 - AF Area (page 63)
 - Auto PF (page 62)

Specifying ISO Sensitivity

You can change the ISO sensitivity setting for better images in places where lighting is dim or when you are using faster shutter speeds.

- ISO sensitivity is expressed in terms of values that originally indicated the sensitivity to light for photographic film. A larger value indicates higher sensitivity, which is better for recording when available lighting is dim.

- 1. In the REC mode, press [MENU].**
- 2. Select the “REC” tab, select “ISO”, and then press [▶].**
- 3. Use [▲] and [▼] to select the setting you want and then press [SET].**

OTHER RECORDING FUNCTIONS

• EX-Z30

| To get this: | Select this setting: |
|---------------------------------|----------------------|
| Automatic sensitivity selection | Auto |
| Conforms to ISO 50 | ISO 50 |
| Conforms to ISO 100 | ISO 100 |
| Conforms to ISO 200 | ISO 200 |
| Conforms to ISO 400 | ISO 400 |

• EX-Z40

| To get this: | Select this setting: |
|---------------------------------|----------------------|
| Automatic sensitivity selection | Auto |
| Conforms to ISO 50 | ISO 50 |
| Conforms to ISO 100 | ISO 100 |
| Conforms to ISO 200 | ISO 200 |
| Conforms to ISO 400 | ISO 400 |

▶▶ IMPORTANT! ◀◀

- Under certain conditions, a high shutter speed in combination with a high ISO sensitivity setting can cause digital noise to appear inside of an image. For clean, good-quality images, use the lowest ISO sensitivity setting possible.
- Using a high ISO sensitivity setting along with the flash to shoot a nearby subject may result in improper illumination of the subject.

▶▶ NOTE ◀◀

- You can use the key customization feature (page 89) to configure the camera so the ISO sensitivity setting changes whenever you press [◀] and [▶] while in the REC mode.

Turning the On-screen Grid On and Off

You can display gridlines on the monitor screen to help you compose images and ensure that the camera is straight when recording.

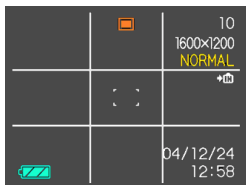

1. In the REC mode, press [MENU].
2. Select the “REC” tab, select “Grid”, and then press [▶].
3. Use [▲] and [▼] to select the setting you want, and then press [SET].

| To do this: | Select this setting: |
|------------------|----------------------|
| Display the grid | On |
| Hide the grid | Off |

Turning Image Review On and Off

Image review displays an image on the monitor screen as soon as you record it. Use the following procedure to turn image review on and off.

1. In the REC mode, press [MENU].
2. Select the “REC” tab, select “Review”, and then press [▶].
3. Use [▲] and [▼] to select the setting you want, and then press [SET].

| To do this: | Select this setting: |
|---|----------------------|
| Display images on the monitor screen for about one second immediately after they are recorded | On |
| Do not display images immediately after they are recorded | Off |

Assigning Functions to the [◀] and [▶] Keys

A “key customization” feature lets you configure the [◀] and [▶] keys so they change camera settings whenever they are pressed in the REC mode. After you configure the [◀] and [▶] keys, you can change the setting assigned to them without going through the menu screen.

1. In the REC mode, press [MENU].
2. Select the “REC” tab, select “L/R Key”, and then press [▶].
3. Use [▲] and [▼] to select the setting you want, and then press [SET].

| When you want to assign this function to [◀] and [▶] keys: | Select this: |
|--|---------------|
| Recording mode • [◀] and [▶] cycle through recording modes: Snapshot, BESTSHOT, Movie, Snapshot Audio, Voice Recording (page 183) | REC Mode |
| EV shift • [◀] decreases compensation, [▶] increases compensation (page 67). | EV Shift |
| White balance setting • [◀] and [▶] cycle through white balance settings (page 69). | White Balance |
| ISO sensitivity • [◀] and [▶] cycle through ISO sensitivity settings (page 86). | ISO |
| Self-timer mode • [◀] and [▶] cycle through self-timer modes (page 56). | Self-timer |
| No function assigned | Off |

NOTE

- The initial default setting is “REC Mode”.

Specifying Power On Default Settings

The camera's "mode memory" feature lets you specify the power on default settings individually for the REC mode, flash mode, focus mode, white balance mode, ISO sensitivity, AF Area, digital zoom mode, manual focus position and zoom position. Turning on mode memory for a mode tells the camera to remember the status of that mode when you turn off the camera, and restore it the next time you turn the camera back on. When mode memory is turned off, the camera automatically restores the initial factory default setting for the applicable mode. The following table shows what happens when you turn mode memory on or off for each mode.

| Function | On | Off |
|-----------------------------|-----------------------------------|--|
| REC Mode | Setting when camera is turned off |  Snapshot |
| Flash | | Auto |
| Focus* ¹ | | Auto |
| White Balance | | Auto |
| ISO | | Auto |
| AF Area | | Spot |
| Digital Zoom | | On |
| MF Position | | Last Auto Focus position that was in effect before you switched to manual focus |
| Zoom Position* ² | | Wide |

*1 Focus mode setting is not remembered for the Movie Mode. Mode automatically returns to PF (Pan Focus).

*2 Only the optical zoom position is remembered.

1. In the REC mode, press [MENU].
2. Select the “Memory” tab, select the item you want to change, and then press [▶].
3. Use [▲] and [▼] to select the setting you want, and then press [SET].

| To do this: | Select this setting: |
|--|----------------------|
| Turn on mode memory so settings are restored at power on | On |
| Turn off mode memory so settings are initialized at power on | Off |

▶▶ IMPORTANT! ◀◀

- Note that BESTSHOT mode settings take priority over mode memory settings. If you turn the camera off while in the BESTSHOT mode, all settings except for “REC Mode” and “Zoom Position” will be configured according to the BESTSHOT sample scene when you turn it back on again, regardless of mode memory on/off setting.
- If you turn the camera off while in the Movie mode, the flash will be turned off when you turn the camera back on again, regardless of mode memory on/off setting.

Resetting the Camera

Use the following procedure to reset all of the camera’s settings to their initial defaults as shown under “Menu Reference” on page 183.

1. In the REC mode or the PLAY mode, press [MENU].
2. Select the “Set Up” tab, select “Reset”, and then press [▶].
3. Use [▲] and [▼] to select “Reset”, and then press [SET].
 - To cancel the procedure without resetting, select “Cancel” and press [SET].

PLAYBACK

You can use the camera's built-in monitor screen to view images after you record them.

Basic Playback Operation

Use the following procedure to scroll through files stored in the camera's memory.

1. Press **[▶]** (PLAY) to turn on the camera.

- This enters the PLAY mode.
- This causes an image or a message to appear on the monitor screen.

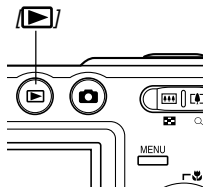

2. Use **[▶]** (forward) or **[◀]** (back) to scroll through files on the monitor screen.



NOTES

- Holding down **[◀]** or **[▶]** scrolls images at high speed.
- In order to allow for faster playback image scrolling, the image that initially appears on the monitor screen is a preview image, which is of somewhat lower quality than the actual display image. The actual display image appears a short while after the preview image. This does not apply to images copied from another digital camera.

Playing an Audio Snapshot

Perform the steps below to display an audio snapshot (indicated by a  indicator) and play its audio.

1. In the **PLAY** mode, use [**◀**] and [**▶**] until the image you want is displayed.
2. Press [**SET**].

- This plays back the audio that accompanies the displayed image.
- You can perform the following operations while audio is playing.



| To do this: | Do this: |
|--|---|
| Fast forward or fast reverse the audio | Hold down [◀] or [▶]. |
| Pause and unpauses audio playback | Press [SET]. |
| Adjust audio volume | Press [▲] or [▼]. |
| Cancel playback | Press [MENU]. |

▶▶ IMPORTANT! ◀◀

- Audio volume can be adjusted only when playback is being performed or is paused.

Flipping the Display

The following procedure flips the image 180 degrees. This comes in handy when you want to show someone standing in front of you an image on the monitor screen.

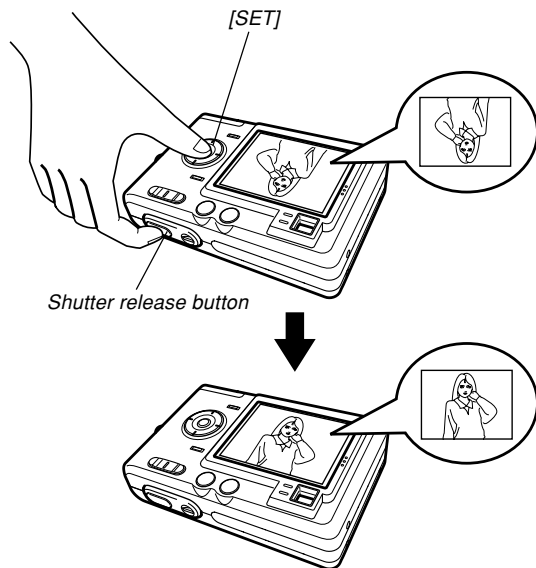

1. In the PLAY mode, use [◀] and [▶] to scroll through images on the monitor screen and display the one you want.

2. While holding down the shutter release button, press [SET].

- This flips the image 180 degrees. The histogram or any other display information you had displayed is cleared automatically whenever you flip the image.
- While an image is flipped, you can use [◀] and [▶] to scroll to another image, if you want.

3. To return the image to its normal orientation, press any button other than [▲], [▼], [◀], or [▶].

▶▶ IMPORTANT! ◀◀

- Note that you cannot play a movie, or a voice recording on the monitor screen while a flipped image is displayed.
- You cannot use the above procedure to flip an image while a zoomed image, 9-image screen, calendar screen image, a movie image, an audio snapshot, or a voice recording file image is on the display.

Zooming the Display Image

Perform the following procedure to zoom the image currently on the monitor screen up to four times its normal size.

1. In the **PLAY** mode, use [**◀**] and [**▶**] to display the image you want.

2. Press the zoom button (**Q**) to enlarge the image.

- This displays an indicator that shows the current zoom factor.
- You can toggle between the zoomed image and normal image by pressing [**MENU**].

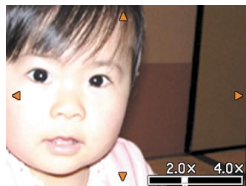

Current zoom factor

3. Use [**▲**], [**▼**], [**◀**], and [**▶**] to shift the image up, down, left, or right.

4. Press [**MENU**] to return the image to its original size.

▶▶ IMPORTANT! ◀◀

- You cannot enlarge a movie image.
- Depending on the original size of the recorded image, you may not be able to zoom a display image the full four times its normal size.

Resizing an Image

You can use the following procedure to change a snapshot image to either SXGA size (1280 x 960 pixels) or VGA size (640 x 480 pixels).

- VGA is the optimum image size for attachment to e-mail messages or incorporation into Web pages.

1. In the **PLAY** mode, press **[MENU]**.

2. Select the **“PLAY”** tab, select **“Resize”**, and then press **[▶]**.



3. Use **[◀]** and **[▶]** to scroll through images and display the one you want to resize.

4. Use **[▲]** and **[▼]** to select the setting you want, and then press **[SET]**.

| To do this: | Select this: |
|------------------------------------|--------------|
| Resize to 1280 x 960 pixels (SXGA) | 1280 x 960 |
| Resize to 640 x 480 pixels (VGA) | 640 x 480 |
| Cancel the resizing operation | Cancel |

▶▶ IMPORTANT! ◀◀

- Resizing an image creates a new file that contains the image in the size you select. The file with the original image also remains in memory.
- Images smaller than 640 x 480 pixels cannot be resized.
- An image recorded using the 2048 x 1360 (3:2) pixel size (EX-Z30) and the 2304 x 1536 (3:2) pixel size (EX-Z40) cannot be resized.
- Note that you can resize snapshots recorded with this camera only.
- If the message “This function is not supported for this file.” appears, it means that the current image cannot be resized.
- The resize operation cannot be performed if there is not enough memory to store the resized image.
- When you display a resized image on the camera’s monitor screen, the date and time indicates when the image was originally recorded, not when the image was resized.

Cropping an Image

Use the following procedure when you want to crop a portion of an enlarged image and use the remaining part of the image as an e-mail attachment, Web page image, etc.

- 1. In the PLAY mode, use [◀] and [▶] to scroll through images and display the one you want to crop.**
- 2. Press [MENU].**
- 3. Select the “PLAY” tab, select “Trimming”, and then press [▶].**
 - This causes a cropping boundary to appear.
- 4. Use the zoom button (⏏ 🔍) to make the cropping boundary larger or smaller.**
 - The size of the cropping boundary depends on the size of the image on the display.

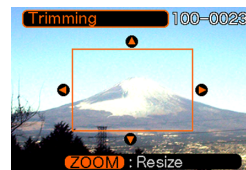

5. Use [▲], [▼], [◀], and [▶] to move the **cropping boundary up, down, left, or right until the area of the image you want to extract is within the boundary.**
6. **Press [SET] to extract the part of the image enclosed in the cropping boundary.**
 - If you want to cancel the procedure at any point, press [MENU].

▶▶ IMPORTANT! ◀◀

- Cropping an image creates a new file that contains the cropped image. The file with the original image also remains in memory.
- An image recorded using the 2048 x 1360 (3:2) pixel size (EX-Z30) and the 2304 x 1536 (3:2) pixel size (EX-Z40) cannot be cropped.
- Movie and voice recording file images cannot be cropped.
- An image recorded using another camera model cannot be cropped.
- If the message "This function is not supported for this file." appears, it means that the current image cannot be cropped.
- The cropping operation cannot be performed if there is not enough memory to store the cropped image.
- When you display a trimmed image on the camera's monitor screen, the date and time indicates when the image was originally recorded, not when the image was trimmed.

Playing a Movie

Use the following procedure to play back a movie that was recorded in the movie mode.

1. In the **PLAY** mode, press [**◀**] and [**▶**] to scroll through images until the movie you want to play is displayed.

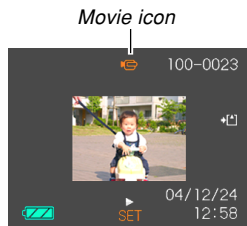

2. Press [**SET**].

- This start playback of the movie.
- You can perform the following operations while a movie is playing.

| To do this: | Do this: |
|---|---|
| Fast forward or fast reverse the movie | Hold down [◀] or [▶]. |
| Pause and unpause movie playback | Press [SET]. |
| Skip forward or back one frame while paused | Press [◀] or [▶]. |
| Cancel playback | Press [MENU]. |
| Adjust audio volume | Press [▲] or [▼]. |

▶▶ IMPORTANT! ◀◀

- You cannot repeat play a movie. To play a movie more than once, repeat the steps of the above procedure.
- This camera can also play back audio recordings. Note the following points when playing back audio.
 - Audio volume can be adjusted only when playback is being performed or is paused.

Displaying the 9-image View

The following procedure displays nine images on the monitor screen at the same time.

1. In the PLAY mode, press the zoom button (⏏).

- This displays the 9-image screen with the image that was on the monitor screen in step 2 in the center, with a selection boundary around it.
-  is displayed in the 9-image screen to indicate voice recording file images (page 111).
- When there are nine or fewer images, they are displayed in order with Image 1 in the upper left corner, with the selection boundary around it.

2. Use [▲], [▼], [◀], and [▶] to move the selection boundary to the image you want. Pressing [▶] while the selection boundary is in the right column or [◀] while it is in the left column scrolls to the next full screen of nine images.

Example: When there are 20 images in memory, and Image 1 is displayed first

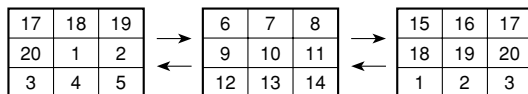

3. Pressing any button besides [▲], [▼], [◀], or [▶] displays the full-size version of the image where the selection boundary is located.

Selecting a Specific Image in the 9-image View

1. Display the 9-image view.

2. Use [▲], [▼], [◀], and [▶] to move the selection boundary up, down, left, or right until it is located at the image you want to view.

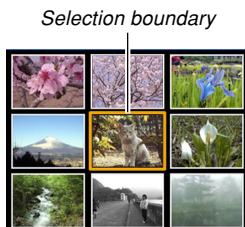

3. Pressing any button besides [▲], [▼], [◀], or [▶] displays the selected image.

- This displays the full-size version of the image you selected.



Displaying the Calendar Screen



Use the following procedure to display a 1-month calendar. While the calendar is on the display, you can select a date, which displays the first image recorded on that date. This helps to make it easy to find the images you want.

1. In the PLAY mode, press [▲] (📅).

2. Use [▲], [▼], [◀], and [▶] to move the date selection cursor.

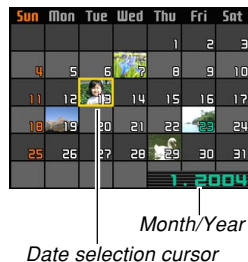
- Use the procedure under “Changing the Date Format” on page 129 to specify the date format.
- The image displayed on the calendar for each date is the first image that was recorded on that date.



- Pressing [▲] while the date selection cursor is located anywhere in the top line of the calendar causes the previous month to appear.
 - Pressing [▼] while the date selection cursor is located anywhere in the bottom line of the calendar causes the next month to appear.
 - To exit the calendar screen, press [MENU] or [DISP].
 -  is displayed in the calendar screen to indicate voice recording file images (page 111).
 -  appears in place of the image when the date contains data that cannot be displayed by this camera.
- 3. To view the large version of a date's image, move the date selection cursor to the date and then press [SET].**
- This displays the first image that was recorded on the selected date.

Playing a Slide Show

Slide Show automatically plays back images in sequence at a fixed interval.



- 1. In the PLAY mode, press [MENU].**
- 2. Select the “PLAY” tab, select “Slideshow”, and then press [▶].**

3. Configure the slideshow settings.

- See the pages indicated below for more information.

| For information about configuring this setting: | Go here: |
|---|---|
| Images | "To specify the slideshow images" on page 104 |
| Time | "To specify the slideshow time" on page 105 |
| Interval | "To set the slideshow interval" on page 105 |
| Cancel | To exit the slideshow setting screen and cancel the slideshow, use [▲] and [▼] to select "Cancel" and then press [SET]. |

4. Use [▲] and [▼] to select "Start", and then press [SET].

- This starts the slide show.

5. To stop Slide Show, press [SET].

- The slideshow will also stop automatically after the amount of time you specified for "Time" elapses.

▶▶ IMPORTANT! ◀◀

- Note that all buttons are disabled while an image change is in progress. Wait until an image is stopped on the monitor screen before performing a button operation, or hold down the button until the image stops.
- When the slideshow comes to a movie file, it plays the movie once and advances to the next file.
- When the slideshow comes to an audio snapshot or voice recording file, it plays the audio once and then advances to the next file.
- While audio is playing, you can use [▲] and [▼] to adjust the volume level.
- Images copied from another digital camera or a computer may take longer time to appear than the slideshow interval time you specify.
- If there are indicators on the display, you can clear them by pressing [DISP] (page 25).

To specify the slideshow images

1. Use [▲] and [▼] to select “Images”, and then press [▶].
2. Use [▲] and [▼] to select the setting you want, and then press [SET].

| To do this: | Select this setting: |
|--|----------------------|
| Include all files in file memory in the slideshow | All images |
| Display a single file | One Image |
| Include all files in the FAVORITE folder (page 116) in the slideshow | Favorites |

3. Use [▲] and [▼] to select “Start”, and then press [SET].
 - This starts the slideshow.
 - The audio of audio snapshot and voice recording files is also played back.

■ Selecting a Particular Image for a Slideshow

When you select “One image” as the slideshow type, the slide show displays only one image, without changing it. Use this setting when you want a particular image to remain on the display while the camera is on the USB cradle (Photo Stand feature).

1. Select “One image”, and then press [▶].
2. Use [◀] and [▶] to scroll through the images until the one you want to use is on the monitor screen.
3. Press [SET] to register your selection and return to the menu screen.

- Pressing [MENU] instead of [SET] returns to the menu screen without registering the setting.



To specify the slideshow time

1. Use [▲] and [▼] to select “Time”.
2. Use [◀] and [▶] to specify the time setting you want, and then press [SET].
 - You can specify a time in the range of 1 to 60 minutes.
3. Use [▲] and [▼] to select “Start”, and then press [SET].
 - This starts the slideshow.

To set the slideshow interval

1. Use [▲] and [▼] to select “Interval”.
2. Use [◀] and [▶] to specify the interval setting you want, and then press [SET].
 - You can specify “MAX”, or a value in the range of 1 to 30 seconds as the interval.
 - When “MAX” is selected for the interval, only the first frame of movie files is played.
3. Use [▲] and [▼] to select “Start”, and then press [SET].
 - This starts the slideshow.

Using the Photo Stand Feature

The “Photo Stand” feature lets you specify what should appear on the camera’s monitor screen while the camera is on its USB cradle. You can play a Photo Stand slideshow without worrying about remaining battery power, or you can specify display of a particular image. Photo Stand feature operations are performed in accordance with slideshow setting. See page 104 for information about configuring slideshow settings to suit your needs.

1. Set the camera onto the USB cradle.

- Do not place the camera onto the USB cradle while it is turned on.

2. Press the USB cradle’s [PHOTO] button.

- This starts the Photo Stand slideshow with the images or image you specified under “To specify the slideshow images” (page 104).

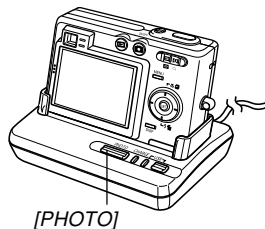

- Pressing [MENU] displays a screen for configuring slideshow settings. To restart the slideshow, press [MENU] while the menu screen is displayed, or select “Start” and then press [SET].
- While audio is playing, you can use [▲] and [▼] to adjust the volume level.

3. To stop the Phot Stand slideshow, press [PHOTO] again.

▶▶ IMPORTANT! ◀◀

- The battery is not charged while a Photo Stand slideshow is in progress. To charge the battery, stop the slideshow.

Rotating the Display Image

Use the following procedure to rotate the image 90 degrees and register the rotation information along with the image. After you do this, the image is always displayed in its rotated orientation.

1. In the **PLAY** mode, press **[MENU]**.
2. Select the **“PLAY”** tab, select **“Rotation”**, and then press **[▶]**.
3. Use **[◀]** and **[▶]** to scroll through images until the one you want to rotate is on the monitor screen.

4. Use **[▲]** and **[▼]** to select **“Rotate”**, and then press **[SET]**.

- Each press of **[SET]** rotates the image 90 degrees.

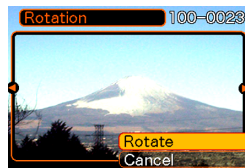

5. After you are finished configuring settings, press the **[MENU]** button to exit the setting screen.

▶▶ IMPORTANT! ◀◀

- You cannot rotate an image that is protected. To rotate such an image, first unprotect it.
- You may not be able to rotate a digital image that was recorded with another type of digital camera.
- You cannot rotate movie or voice record images.

Using Image Roulette

Image Roulette cycles images like a slot machine on the display, before stopping at one of them. When you start an Image Roulette operation, images scroll randomly on the screen. At first, images scroll at high speed. Then the scrolling gradually slows down until a single image is stopped on the screen. The image that finally appears is random, and subject to no rules or system.

1. While the camera is turned off, hold down [◀] as you press [▶] (PLAY) to turn it on.

- Keep [◀] held down until images appear on the monitor screen.
- This starts the Image Roulette operation, scrolling images on the display, finally stopping at one.

2. Press [◀] or [▶] to restart the Image Roulette operation.

3. To turn off Image Roulette, press [📷] (REC) to enter the REC mode or press the power button to turn off the camera.

▶▶ IMPORTANT! ◀◀

- Image Roulette does not play movie files or display voice recording images.
- Image Roulette is disabled when there is only one snapshot image available.
- Note that Image Roulette works only with images recorded with this camera. Image Roulette may not operate properly when other types of images are in memory.
- If you do not start another Image Roulette operation for about one minute after the final image appears, the camera enters its normal PLAY mode.
- You can use Image Roulette while “Power On” or “Power On/Off” is selected for the “REC/PLAY” setting (page 133).

Adding Audio to a Snapshot

The “after-recording” feature lets you add audio to snapshots after they are recorded. You can also re-record an audio image (one with a  icon on it).

- **Audio Format:** WAVE/ADPCM recording format
This is the Windows standard format for audio recording. The file extension of a WAVE/ADPCM file is “.WAV”.
- **Recording Time:**
Up to about 30 seconds per image
- **Audio File Size:**
Approximately 120KB (30-second recording of approximately 4KB per second)

1. In the PLAY mode, use [◀] and [▶] to scroll through snapshots until the one to which you want to add audio is displayed.

2. Press [MENU].

3. Select the “PLAY” tab, select “Dubbing”, and then press [▶].



4. Press the shutter release button to start audio recording.

5. Recording stops after about 30 seconds or when you press the shutter release button.

To re-record audio

1. In the PLAY mode, use [◀] and [▶] to scroll through snapshots until the one whose audio you want to re-record is displayed.
2. Select the “PLAY” tab, select “Dubbing”, and then press [▶].
3. Use [▲] and [▼] to select “Delete”, and then press [SET].
 - If you merely want to delete the audio with re-recording, press [MENU] here to complete the procedure.
4. Press the shutter release button to start audio recording.
5. Recording stops after about 30 seconds or when you press the shutter release button.
 - This deletes the previous recording and replaces it with a new one.

▶▶ IMPORTANT! ◀◀

- Keep the microphone on the front of the camera pointed at the subject.
- Take care that you do not block the microphone with your fingers.
- Good recording results are not possible when the camera is too far from the subject.
- Operating camera buttons during recording can cause button noise to be included in the audio.
- The  (Audio) icon appears on the monitor screen after audio recording is complete.
- You will not be able to record audio when remaining memory capacity is low.
- The following types of audio recording are not supported.
 - Adding audio to a movie image
 - Adding audio to a protected snapshot (page 115)
- Audio that is re-recorded or deleted cannot be recovered. Make sure you no longer need audio before re-recording or deleting it.

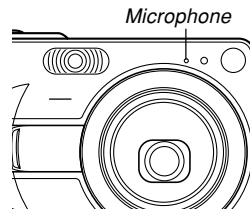

Playing Back a Voice Recording File

Perform the following steps to play back a voice recording file.

1. In the PLAY mode, use [◀] and [▶] to display the voice file (a file with  on it) you want to play.

2. Press [SET].

- This starts playback of the voice recording file through the camera's speaker.
- You can perform the following operations while audio is playing.



| To do this: | Do this: |
|--|-----------------------|
| Fast forward or fast reverse the audio | Hold down [◀] or [▶]. |
| Pause and unpause audio playback | Press [SET]. |
| Adjust audio volume | Press [▲] or [▼]. |
| Cancel playback | Press [MENU]. |

▶▶ IMPORTANT! ◀◀

- Audio volume can be adjusted only when playback is being performed or is paused.
- If your recording has index marks (page 83) inside it, you can jump to the index mark before or after the current playback location by pausing playback and then pressing [◀] or [▶]. Next, press [SET] to resume playback from the index mark position.

DELETING FILES

You can delete a single file, or you can delete all files currently in memory.

»» IMPORTANT! ««

- Note that file deletion cannot be undone. Once you delete a file, it is gone. Make sure you really do not need a file anymore before you delete it. Especially when deleting all files, make sure you check all the files you have stored before proceeding.
- A protected file cannot be deleted. To delete a protected file, unprotect it first (page 115).
- Delete cannot be performed when all the files in memory are protected (page 116).
- Deleting an audio snapshot deletes both the image file and the audio file attached to it.

Deleting a Single File

Perform the following steps when you want to delete a single file.

1. In the **PLAY** mode, press [**▼**] (⚡ 🗑️).

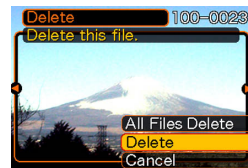

2. Use [**◀**] and [**▶**] to scroll through files and display the one you want to delete.
3. Use [**▲**] and [**▼**] to select “Delete”.
 - To exit the file delete operation without deleting anything, select “Cancel”.
4. Press [**SET**] to delete the file.
 - Repeat steps 2 through 4 to delete other files, if you want.
5. Press [**MENU**] to exit the menu screen.

▶▶ IMPORTANT! ◀◀

- If a file cannot be deleted for some reason, the message “This function is not supported for this file.” appears when you try to delete it.

Deleting All Files

The following procedure deletes all unprotected files currently in memory.

- 1. In the PLAY mode, press [▼] (↓ ↵).**
- 2. Use [▲] and [▼] to select “All Files Delete”, and then press [SET].**
- 3. Use [▲] and [▼] to select “Yes”.**
 - To exit the file delete operation without deleting anything, select “No”.
- 4. Press [SET] to delete all the files.**
 - The message “There are no files.” appears on the screen after all of the files are deleted.

FILE MANAGEMENT

The file management capabilities of the camera make it easy to keep track of images. You can protect files against deletion and store the files you want in the camera's built-in memory.

Folders

Your camera automatically creates a directory of image storage folders in its built-in Flash memory or on the memory card.

Memory Folders and Files

An image you record is automatically stored in a folder, whose name is a serial number. You can have up to 900 folders in memory at the same time. Folder names are generated as shown below.

Example: Name of the 100th folder.

100CASIO

|
Serial number (3 digits)

Each folder can hold files numbered up to 9,999. Trying to store the 10,000th file in a folder causes the next serially numbered folder to be created. Folder names are generated as shown below.

Example: Name of the 26th file

CIMG0026.JPG

| |
Extension

|
Serial number (4 digits)

- The actual number of files you will be able to store on a memory card depends on the image quality settings, capacity of the card, etc.
- For details about the directory structure, see "Memory Directory Structure" on page 163.

Protecting Files

Once you protect a file it cannot be deleted (page 112). You can protect files individually or you can protect all files in memory with a single operation.

To protect a single file

1. In the **PLAY** mode, press **[MENU]**.
2. Select the “**PLAY**” tab, select “**Protect**”, and then press **[▶]**.
 
3. Use **[◀]** and **[▶]** to scroll through files and display the one you want to protect.

4. Use **[▲]** and **[▼]** to select “**On**”, and then press **[SET]**.

- A file that is protected is indicated by the  mark.
- To unprotect a file, select “**Off**” in step 4, and then press **[SET]**.

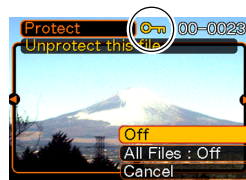

5. Press **[MENU]** to exit the menu screen.

To protect all files in memory

1. In the **PLAY** mode, press **[MENU]**.
2. Select the **“PLAY”** tab, select **“Protect”**, and then press **[▶]**.
3. Use **[▲]** and **[▼]** to select **“All Files : On”**, and then press **[SET]**.
 - To unprotect all files, press **[SET]** in step 3 so the setting shows **“All Files : Off”**.
4. Press **[MENU]** to exit the menu screen.

Using the FAVORITE Folder

You can copy scenery shots, photos of your family, or other special images from a file storage folder (page 163) to the FAVORITE folder in built-in memory (page 163). Images in the FAVORITE folder are not displayed during normal playback, so it helps to keep your personal image private as you carry them around. FAVORITE folder images are not deleted when you change memory cards, so you can always keep them on hand.

To copy a file to the FAVORITE folder

1. In the **PLAY** mode, press **[MENU]**.
2. Select the **“PLAY”** tab, select **“Favorites”**, and then press **[▶]**.

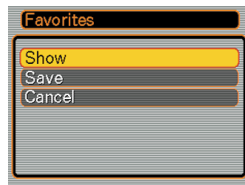

3. Use [▲] and [▼] to select “Save”, and then press [SET].

- This displays the names of the files in built-in memory or on the loaded memory card.



4. Use [◀] and [▶] to select the file you want to copy to the FAVORITE folder.

5. Use [▲] and [▼] to select “Save”, and then press [SET].

- This copies the displayed file to the FAVORITE folder.

6. After copying all of the files you want, use [▲] and [▼] to select “Cancel”, and then press [SET] to exit.

»» NOTES ««

- Copying an image file with the above procedure creates a 320 x 240-pixel QVGA-size image in the FAVORITE folder.
- A file copied into the FAVORITE folder is automatically assigned a file name that is a serial number. Though the serial number starts from 0001 and can go as high as 9999, the actual upper end of the range depends on built-in memory capacity. Remember that the maximum number of images that can be stored in built-in memory depends on the size of each image and other factors.

»» IMPORTANT! ««

- Note that an image that has been copied to the FAVORITE folder and then resized cannot be returned to its original size.
- Files in the FAVORITE folder cannot be copied to a memory card.

To display a file in the FAVORITE folder

1. In the PLAY mode, press [MENU].
2. Select the “PLAY” tab, select “Favorites”, and then press [▶].
3. Use [▲] and [▼] to select “Show”, and then press [SET].
 - If the FAVORITE folder is empty, the message “No Favorites file!” appears.
4. Use [▶] (forward) and [◀] (back) to scroll through the files in the FAVORITE folder.
5. After you are finished viewing files, press [MENU] twice to exit.



NOTE

- Holding down [◀] or [▶] scrolls images at high speed.

IMPORTANT!

- Note that a FAVORITE folder is created in the camera's built-in memory only. No FAVORITE folder is created on a memory card when you use one. If you want to view the contents of the FAVORITE folder on your computer screen, you need to remove the memory card from the camera (if you are using one) before placing the camera onto the USB cradle to start data communication (pages 151, 157).

To delete a file from the FAVORITE folder

1. In the **PLAY** mode, press [MENU].
2. Select the “PLAY” tab, select “Favorites”, and then press [▶].
3. Use [▲] and [▼] to select “Show”, and then press [SET].
4. Press [▼] (⚡ .
5. Use [◀] and [▶] to select the file you want to delete from the FAVORITE folder.
6. Use [▲] and [▼] to select “Delete”, and then press [SET].
 - To exit the file delete operation without deleting anything, select “Cancel”.
7. After deleting all of the files you want, use [▲] and [▼] to select “Cancel”, and then press [SET] to exit.

▶▶ IMPORTANT! ◀◀

- You cannot use the delete operations on page 112 to delete images from the FAVORITE folder. Performing the memory format operation (page 135), however, does delete FAVORITE folder files.

To delete all files from the FAVORITE folder

1. In the PLAY mode, press [MENU].
2. Select the “PLAY” tab, select “Favorites”, and then press [▶].
3. Use [▲] and [▼] to select “Show”, and then press [SET].
4. Press [▼] (⚡ )
5. Use [▲] and [▼] to select “All Files Delete”, and then press [SET].

▶▶ IMPORTANT! ◀◀

- You cannot use the delete operations on page 112 to delete images from the FAVORITE folder. Performing the memory format operation (page 135), however, does delete FAVORITE folder files.

OTHER SETTINGS

Configuring Sound Settings

You can configure different sounds to play whenever you turn on the camera, press the shutter release button halfway or all the way, or perform a key operation.

To configure sound settings

1. In the REC mode or the PLAY mode, press [MENU].
2. Select the “Set Up” tab, select “Sounds”, and then press [▶].
3. Use [▲] and [▼] to select the sound whose setting you want to configure, and then press [▶].

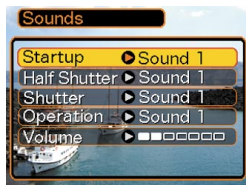

4. Use [▲] and [▼] to change the setting, and then press [SET].

| To do this: | Select this setting: |
|-------------------------|-------------------------|
| Select a built-in sound | Sound 1 through Sound 5 |
| Turn off the sound | Off |

NOTE

- The default sound setting for all operations is “Sound 1”.

To set the volume level

1. In the REC mode or the PLAY mode, press [MENU].
2. Select the “Set Up” tab, select “Sounds”, and then press [▶].
3. Use [▲] and [▼] to select “Volume”.
4. Use [◀] and [▶] to specify the volume setting you want, and then press [SET].
 - You can set the volume in the range of 0 (no sound) to 7 (loudest).

NOTE

- The initial default volume setting is 3.

Specifying an Image for the Startup Screen

You can specify an image you recorded as the startup screen image, which causes it to appear on the monitor screen for about two seconds whenever you press the power button or [📷] (REC) to turn on the camera. The startup screen image does not appear if you press [▶] (PLAY) to turn on the camera.

1. In the REC mode or the PLAY mode, press [MENU].
2. Select the “Set Up” tab, select “Startup”, and then press [▶].
3. Use [◀] and [▶] to display the image you want to use as the startup image.
4. Use [▲] and [▼] to change the setting, and then press [SET].

| To do this: | Select this setting: |
|---|----------------------|
| Use the currently displayed image as the startup screen image | On |
| Disable the startup screen | Off |

»» IMPORTANT! ««

- You can select any one of the following types of image as the startup image.
 - The camera's built-in startup image
 - A snapshot you recorded with the camera
 - An audio snapshot you recorded with the camera
- The snapshot image that you select as the startup image is stored in a special memory location called "startup image memory". Only one image can be stored in startup image memory at one time. Selecting a new startup image overwrites anything that is already stored in startup image memory. Because of this, if you want to return to a previous startup image, you need to have a separate copy of that image in the camera's standard image memory.
- The startup image is deleted by the format operation (page 135).
- If you store an audio snapshot to startup image memory, the image's audio is not played when the image is displayed at startup.

Configuring Power Down Image Settings

With the Power Down Image feature, you can configure the camera so a specific image stored in camera image memory appears whenever you turn off power. You can specify a snapshot or a movie as the power down image.

■ To configure power down image settings

- 1. Use the USB cable to connect the camera to your computer (page 151).**
- 2. Move the image data that you want to use for the power down image to the top (root) directory of the camera's built-in Flash memory.**
 - The file name extension will not be displayed if your computer is configured to hide file name extensions. Example: CIMG0001
 - If your power down image is stored on a memory card, be sure to copy the image to built-in memory before removing the memory card from the camera.

3. Change the name of the file to one of the following.

Snapshot Image: ENDING.JPG

Movie Image: ENDING.AVI

- Input the following file name only (without file name extension) if your computer is configured to hide file name extensions.

File Name: ENDING

- Your camera is now configured to display a power down image. The power down image will appear any time you press the power button to turn off the camera. The power down image appears regardless of whether or not your camera has a memory card loaded in it.

▶▶ IMPORTANT! ◀◀

- Only a snapshot (JPEG) or movie (AVI) file can be used as the power down image.
- Note that the Power Down Image feature works only with images recorded with this camera. The Power Down Image feature may not operate properly when another type of image is specified as the power down image.
- Formatting the camera's Flash memory deletes the power down image.
- When both a still image and a movie are present for the power down image, only the movie is used.
- Note that a power down image display operation cannot be interrupted once it starts. Because of this, you should select a relatively short movie when using a movie file as the power down image.

■ To cancel Power Down Image settings

1. Use the USB cable to connect the camera to your computer (page 151).
2. Change the name of the current power down image from ENDING.JPG or ENDING.AVI to something else, or delete the current power down image from Flash memory.

Specifying the File Name Serial Number Generation Method

Use the following procedure to specify the method for generating the serial number used for file names (page 114).

1. In the REC mode or the PLAY mode, press [MENU].
2. Select the “Set Up” tab, select “File No.,” and then press [▶].
3. Use [▲] and [▼] to change the setting, and then press [SET].

| To do this for a newly saved file: | Select this setting: |
|---|----------------------|
| Store the last file number used and increment it, regardless of whether files are deleted or whether the memory card is replaced with a new one | Continue |
| Find the highest file number in the current folder and increment it | Reset |

Using the Alarm

You can configure up to three alarms that cause the camera to beep and display a specified image at the time you specify. Specifying a movie or an audio snapshot plays back the image and the audio at the assigned time. Specifying a voice recording file plays the audio.

To set an alarm

1. In the **PLAY** mode, press **[MENU]**.
2. Select the **“PLAY”** tab, select **“Alarm”**, and then press **[▶]**.
3. Use **[▲]** and **[▼]** to select the alarm whose setting you want to configure, and then press **[▶]**.
4. Use **[◀]** and **[▶]** to select the setting you want to change, and then use **[▲]** and **[▼]** to change the selected setting.
 - You can set an alarm time and configure the alarm to sound either once or at the same time everyday. You can also turn the alarm on or off.

5. Press **[DISP]**.

- You could press **[SET]** in place of **[DISP]** if you want to configure the alarm without an image.

6. Use **[◀]** and **[▶]** to select the scene you want to appear at the alarm time, and then press **[SET]**.

7. After all the settings are the way you want, press **[SET]**.

- You can configure up to three alarms, named “Alarm 1”, “Alarm 2”, and “Alarm 3”.

Stopping the Alarm

When an alarm time is reached while the camera is turned off, the alarm will sound for about one minute (or until you stop it), and then the camera will turn on. To stop the alarm after it starts to sound, press any button. If the camera is on the USB cradle when an alarm sounds, you can stop it by pressing the USB cradle [USB] button or [PHOTO] button, or any camera button.

▶▶ IMPORTANT! ◀◀

- Note that the alarm does not sound if the alarm time is reached when any one of the following conditions exists.
 - While the camera is turned on
 - While a USB data communication operation is in progress
 - While a Photo Stand operation is in progress

Setting the Clock

Use the procedures in this section to select a Home Time Zone, and to change its date and time settings.

▶▶ IMPORTANT! ◀◀

- Make sure you select your Home Time zone (the zone where you are currently located) before changing the time and date settings. Otherwise, the time and date setting will change automatically when you select another time zone.

To select your Home Time zone

1. In the REC mode or the PLAY mode, press [MENU].
2. Select the “Set Up” tab, select “World Time”, and then press [▶].
 - This displays the current World Time zone.
3. Use [▲] and [▼] to select “Home”, and then press [▶].

4. Use [▲] and [▼] to select “City”, and then press [▶].
5. Use [▲], [▼], [◀], and [▶] to select the geographical area that contains location you want to select as your Home Time zone, and then press [SET].
6. Use [▲] and [▼] to select the city you want, and then press [SET].
7. After selecting the city you want, press [SET] to register its zone as your Home Time zone.

To set the current time and date

1. In the REC mode or the PLAY mode, press [MENU].
2. Select the “Set Up” tab, select “Adjust”, and then press [▶].
3. Set the current date and the time.

| To do this: | Do this: |
|---|-------------------|
| Change the setting at the current cursor location | Press [▲] or [▼]. |
| Move the cursor between settings | Press [◀] or [▶]. |
| Toggle between 12-hour and 24-hour timekeeping | Press [DISP]. |

4. When all the settings are the way you want, press [SET] to register them and exit the setting screen.

Changing the Date Format

You can select from among three different formats for display of the date.

1. In the **REC** mode or the **PLAY** mode, press **[MENU]**.
2. Select the “**Set Up**” tab, select “**Date Style**”, and then press **[▶]**.
3. Use **[▲]** and **[▼]** to change the setting, and then press **[SET]**.

Example: December 24, 2004

| To display the date like this: | Select this format: |
|--------------------------------|---------------------|
| 04/12/24 | YY/MM/DD |
| 24/12/04 | DD/MM/YY |
| 12/24/04 | MM/DD/YY |

Using World Time

You can use the World Time screen to view a time zone that is different from the home time zone when you go on a trip, etc. World Time can display the time in one of 162 cities in 32 time zones.

To display the World Time screen

1. In the **REC** mode or the **PLAY** mode, press **[MENU]**.
2. Select the “**Set Up**” tab, select “**World Time**”, and then press **[▶]**.
 - This displays the current World Time zone.
3. Use **[▲]** and **[▼]** to select “**World**”.

| To do this: | Select this: |
|---|--------------|
| Display the time in your home time zone | Home |
| Display the time in a different time zone | World |

4. Press **[SET]** to exit the setting screen.

To configure World Time settings

1. In the REC mode or the PLAY mode, press [MENU].
2. Select the “Set Up” tab, select “World Time”, and then press [▶].
 - This displays the current World Time zone.
3. Use [▲] and [▼] to select “World”, and then press [▶].
4. Use [▲] and [▼] to select “City”, and then press [▶].
5. Use [▲], [▼], [◀], and [▶] to select the geographical area you want, and then press [SET].



6. Use [▲] and [▼] to select the city you want, and then press [SET].

- This displays the current time in the city you select.



7. When the setting is the way you want, press [SET] to apply it and exit the setting screen.

To configure summer time (DST) settings

1. In the **REC** mode or the **PLAY** mode, press **[MENU]**.
2. Select the “**Set Up**” tab, select “**World Time**”, and then press **[▶]**.
 - This displays the current World Time Settings.
3. Use **[▲]** and **[▼]** to select “**World**”, and then press **[▶]**.
 - If you want to configure Home Time settings, select “**Home**” instead.
4. Use **[▲]** and **[▼]** to select “**DST**”, and then press **[▶]**.
5. Use **[▲]** and **[▼]** to select the summer time (DST) setting you want.

| To do this: | Select this: |
|--|--------------|
| Advance the current time setting by one hour | On |
| Display the current time as-is | Off |

6. After the setting is the way you want, press **[SET]**.

- This displays the current time in accordance with your setting.

7. Press **[SET]** again to exit the setting screen.

Changing the Display Language

You can use the following procedure to select one of ten language as the display language.

1. In the REC mode or the PLAY mode, press [MENU].
2. Select the “Set Up” tab, select “Language”, and then press [▶].
3. Use [▲], [▼], [◀], and [▶] to change the setting, and then press [SET].

| | |
|-----------|------------------------|
| 日本語 | : Japanese |
| English | : English |
| Français | : French |
| Deutsch | : German |
| Español | : Spanish |
| Italiano | : Italian |
| Português | : Portuguese |
| 中國語 | : Chinese (Complex) |
| 中国語 | : Chinese (Simplified) |
| 한국어 | : Korean |

Changing the USB Port Protocol

You can use the procedure below to change the communication protocol of the camera's USB port when connecting to a computer, printer, or other external device. Select the protocol that suits the device to which you are connecting.

1. In the REC mode or the PLAY mode, press [MENU].
2. Select the “Set Up” tab, select “USB”, and then press [▶].
3. Use [▲] and [▼] to select the setting you want, and then press [SET].

| When connecting to this type of device: | Select this setting: |
|--|---------------------------------|
| Computer or USB DIRECT-PRINT-compatible printer (page 146) | Mass Storage (USB DIRECT-PRINT) |
| PictBridge-compatible printer (page 146) | PTP (PictBridge)* |

* “PTP” stands for “Picture Transfer Protocol”.

OTHER SETTINGS

- PTP (PictBridge) simplifies the transfer of image data to the connected device.
- Mass Storage (USB DIRECT-PRINT) causes the camera to see the computer as an external storage device. Use this setting for normal transfer of images from the camera to a computer (using the bundled Photo Loader application).

Configuring [📷] (REC) and [▶] (PLAY) Buttons Power On/Off Functions

You can use the following procedures to configure the [📷] (REC) and [▶] (PLAY) buttons so power turns and/or off whenever they are pressed.

- 1. In the REC mode or the PLAY mode, press [MENU].**
- 2. Select the “Set Up” tab, select “REC/PLAY”, and then press [▶].**
- 3. Use [▲] and [▼] to select the setting you want, and then press [SET].**

OTHER SETTINGS

| To configure this operation: | Select this setting: |
|---|----------------------|
| Power turns on when [RECORD] (REC) or [PLAY] (PLAY) is pressed (but does not turn off) | Power On |
| Power turns on or off when [RECORD] (REC) is pressed in the REC mode or [PLAY] (PLAY) is pressed in the PLAY mode | Power On/Off |
| Power does not turn on or off when [RECORD] (REC) or [PLAY] (PLAY) is pressed | Disable |

▶▶ IMPORTANT! ◀◀

- When “Power On/Off” is selected, pressing [RECORD] (REC) in the REC mode or [PLAY] (PLAY) in the PLAY mode turns off the camera.
- Pressing [RECORD] (REC) in the PLAY mode switches to the REC mode, and pressing [PLAY] (PLAY) in the REC mode switches to the PLAY mode.

▶▶ NOTE ◀◀

- The initial default setting is “Power On”.

Formatting Built-in Memory

Formatting built-in memory deletes any data stored in it.

▶▶ IMPORTANT! ◀◀

- Note that data deleted by a format operation cannot be recovered. Check to make sure you do not need any of the data in memory before you format it.
- Formatting built-in memory deletes all files, including files in the FAVORITE folder (page 116), protected files (page 115), and BESTSHOT user setups (page 73).
- Formatting memory deletes the startup screen image (page 122) and the Power Down Image (page 123).

1. Check to make sure there is no memory card loaded in the camera.

- If there is a memory card loaded in the camera, remove it (page 138).

2. In the REC mode or the PLAY mode, press [MENU].

3. Select the “Set Up” tab, select “Format”, and then press [▶].

4. Use [▲] and [▼] to select “Format”, and then press [SET].

- To exit the format operation without formatting, select “Cancel”.

USING A MEMORY CARD

You can expand the storage capabilities of your camera by using a commercially available memory card (SD memory card or MultiMediaCard). You can also copy files from built-in flash memory to a memory card and from a memory card to flash memory.



- Normally, files are stored in built-in flash memory. When you insert a memory card, however, the camera automatically stores files to the card.
- Note that you cannot save files to built-in memory while a memory card is installed in the camera.

▶▶ IMPORTANT! ◀◀

- Use only an SD memory card or a MultiMediaCard with this camera. Proper operation is not guaranteed when any other type of card is used.
- See the instructions that come with the memory card for information about how to use it.
- Certain types of cards can slow down processing speeds.
- SD memory cards have a write protect switch, which you can use to protect against accidental deletion of image data. Note, however, if you write protect an SD memory card, you must remove write protection whenever you want to record to it, format it, or delete any of its files.
- Electrostatic charge, electrical noise, and other phenomena can cause data to become corrupted or even lost. Always make sure that you always back up important data on other media (CD-R, CD-RW, MO disc, computer hard disk, etc.)

Using a Memory Card

▶▶ IMPORTANT! ◀◀

- Make sure you turn off the camera before inserting or removing a memory card.
- Be sure to orient the card correctly when inserting it. Never try to force a memory card into the slot when you feel resistance.

To insert a memory card into the camera

1. While pressing the battery compartment cover on the bottom of the camera, slide the cover in the direction indicated by the arrow, and then swing it open.

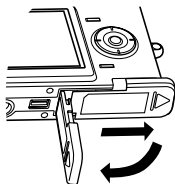

2. Positioning the memory card so its back is facing in the same direction as the camera's monitor screen, carefully slide it into the card slot.

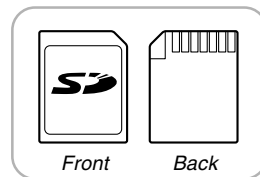
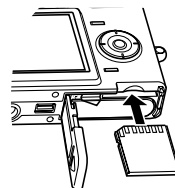

3. Swing the battery compartment cover closed, and then slide it in the direction indicated by the arrow.

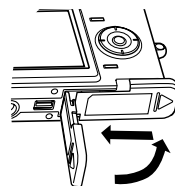

To remove a memory card from the camera

1. Press the memory card into the camera and then release it. This will cause the card to come part way out of the camera.

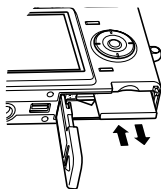

2. Pull the memory card out of the slot.

▶▶ IMPORTANT! ◀◀

- Never insert any other object besides a memory card into the camera's card slot. Doing so creates the risk of damage to the camera and card.
- Should water or any foreign object ever get into the card slot, immediately turn off the camera, remove the battery, and contact your dealer or nearest CASIO authorized service center.
- Never remove a card from the camera while the green operation lamp is flashing. Doing so can cause the file save operation to fail, and even damage the memory card.

Formatting a Memory Card

Formatting a memory card deletes any data already stored on it.

▶▶ IMPORTANT! ◀◀

- Be sure to use the camera to format a memory card. Formatting a memory card on a computer and then using it in the camera can slow down data processing by the camera. In the case of an SD card, formatting on a computer can result in non-conformity with the SD format, causing problems with compatibility, operation, etc.
- Note that data deleted by a memory card format operation cannot be recovered. Check to make sure you do not need any of the data on the memory card before you format it.
- Formatting a memory card that contains files deletes all the files, even those that are protected (page 115).

1. Load the memory card into the camera.
2. Turn on the camera. Next, enter the REC mode or PLAY mode and press [MENU].
3. Select the “Set Up” tab, select “Format”, and then press [▶].
4. Use [▲] and [▼] to select “Format”, and then press [SET].
 - To exit the format operation without formatting, select “Cancel”.

Memory Card Precautions

- If a memory card starts to behave abnormally, you can restore normal operation by reformatting it. However, we recommend that you always take along more than one memory card whenever using the camera far away from the home or office.
- We recommend that you format a memory card before using it for the first time after purchasing it, or whenever the card you are using seems to be the cause of abnormal images.
- Before starting a format operation, check to make sure that the battery is fully charged. Power interruption during the format operation can result in improper formatting, and even damage the memory card and make it unusable.

Copying Files

Use the procedures below to copy files between built-in memory and a memory card.

▶▶ IMPORTANT! ◀◀

- Only snapshot, movie files, audio snapshot, and voice recording files recorded with this camera can be copied. Other files cannot be copied.
- Files in the FAVORITE folder cannot be copied.
- Copying an audio snapshot copies both the image file and the audio file.

To copy all the files in built-in memory to a memory card

1. Load the memory card into the camera.
2. Turn on the camera. Next, enter the PLAY mode and press [MENU].
3. Select the “PLAY” tab, select “Copy”, and then press [▶].



4. Use [▲] and [▼] to select “Built-in → Card”, and then press [SET].

- This starts the copy operation and displays the message “Busy.... Please wait...”.
- After the copy operation is complete, the monitor screen shows the last file in the folder.

To copy a file from a memory card to built-in memory

With this procedure you can copy one file at a time.

1. Perform steps 1 through 3 of the procedure under “To copy all the files in built-in memory to a memory card”.
2. Use [▲] and [▼] to select “Card → Built-in”, and then press [SET].
3. Use [◀] and [▶] to select the file you want to copy.
4. Use [▲] and [▼] to select “Copy”, and then press [SET].
 - This starts the copy operation and displays the message “Busy.... Please wait...”.
 - The file reappears on the monitor screen after the copy operation is complete.
 - Repeat steps 3 through 4 to copy other images, if you want.
5. Press [MENU] to exit the copy operation.

NOTE

- Files are copied to the folder in built-in memory whose name has the largest number.

PRINTING IMAGES

A digital camera provides you with a variety of different ways to print the images it records. The three main printing methods are described below. Use the method that best suits your needs.

■ Professional Print Service

The camera's DPOF feature lets you specify which images you want to print and how many copies of each you want. Then, simply take the memory card to a professional print service where they will print your images in accordance with your specifications. For more information, see "DPOF" (page 143).

■ Printing Directly on a Printer Equipped with a Card Slot, or a Printer that Supports USB DIRECT-PRINT or PictBridge

The camera's DPOF feature lets you specify which images you want to print and how many copies of each you want. Then you can plug the memory card into a printer equipped with a card slot, or connect the camera to a PictBridge or USB DIRECT-PRINT printer for printing. For more information, see "DPOF" (page 143) and "Using PictBridge or USB DIRECT-PRINT" (page 146).

■ Printing with a Computer

Windows Users

The camera comes bundled with Photo Loader and Photohands applications (page 175), which can be installed on a Windows computer for image transfer, management, and printing. For more information, see "Viewing Images on a Computer" (page 151) and "Installing the Software from the CD-ROM" (page 174).

▶▶ IMPORTANT! ◀◀

- Refer to the pages referenced above for information about how to connect the camera to a computer. Image management procedures are provided in the following pages of this section.

Macintosh Users

The camera comes bundled with Photo Loader for the Macintosh, which can be installed for image transfer and management, but not for printing. Use commercially available software for printing with a Macintosh. For more information, see “Viewing Images on a Computer” (page 151) and “Installing the Software from the CD-ROM” (page 174).

▶▶ IMPORTANT! ◀◀

- Refer to the pages referenced above for information about how to connect the camera to a computer. Image management procedures are provided in the following pages of this section.

DPOF

The letters “DPOF” stand for “Digital Print Order Format”, which is a format for recording on a memory card or other medium which digital camera images should be printed and how many copies of the image should be printed. Then you can print on a DPOF-compatible printer or at a professional print service in accordance with the file name and number of copies settings recorded on the card.

With this camera, you should always select images by viewing them on the monitor screen. Do not specify images by file name without viewing the file contents.



■ DPOF Settings

File Name,
number of copies,
date

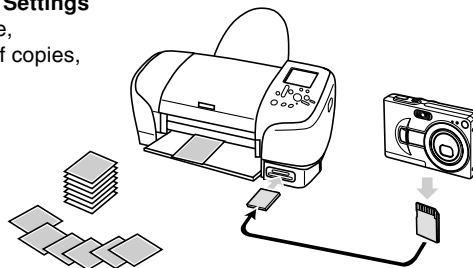

To configure print settings for a single image

1. In the **PLAY** mode, press **[MENU]**.

2. Select the “**PLAY**” tab, select “**DPOF**”, and then press **[▶]**.



3. Use **[▲]** and **[▼]** to select “**Select images**”, and then press **[▶]**.



4. Use **[◀]** and **[▶]** to display the image you want.



5. Use **[▲]** and **[▼]** to specify the number of copies.

- You can specify up to 99 for the number of copies. Specify 00 if you do not want to have the image printed.

6. To turn on date stamping for the prints, press **[DISP]** so  is displayed.

-  indicates that date stamping is turned on.
- To turn off date stamping for the prints, press **[DISP]** so  is not displayed.
- Repeat steps 4 through 6 if you want to configure other images for printing.

7. After all the settings are the way you want, press **[SET]** to apply them.



To configure print settings for all images

1. In the **PLAY** mode, press **[MENU]**.
2. Select the **“PLAY”** tab, select **“DPOF”**, and then press **[▶]**.
3. Use **[▲]** and **[▼]** to select **“All images”**, and then press **[▶]**.
4. Use **[▲]** and **[▼]** to specify the number of copies.

- You can specify up to 99 for the number of copies. Specify 00 if you do not want to have the image printed.



5. To turn on date stamping for the prints, press **[DISP]** so  is displayed.

-  indicates that date stamping is turned on.
- To turn off date stamping for the prints, press **[DISP]** so  is not displayed.

6. After all the settings are the way you want, press **[SET]** to apply them.

ⓘ IMPORTANT! ⓘ

- If you take a memory card to a professional print service, be sure to tell them that it includes DPOF settings for the images to be printed and the number of copies. If you don't, they may print all images on the card, including the ones you do not want printed.
- Note that some professional print services do not support DPOF printing. Check with your service before ordering prints.
- Some printers may have settings that disable date stamp and/or DPOF printing. See the user documentation that comes with your printer for details about how to enable these features.

Using PictBridge or USB DIRECT-PRINT

You can connect the camera directly to a printer that supports PictBridge or USB DIRECT-PRINT, and perform image selection and printing using the camera monitor screen and controls. DPOF support (page 143) also lets you specify which images you want to print and how many copies of each should be printed.

- PictBridge is a standard established by the Camera and Imaging Products Association (CIPA).
- USB DIRECT-PRINT is a standard proposed by Seiko Epson Corporation.



To print a single image

1. In the REC mode or the PLAY mode, press [MENU].
2. Select the “Set Up” tab, select “USB”, and then press [▶].
3. Use [▲] and [▼] to select the setting you want, and then press [SET].

| When connecting to this type of device: | Select this setting: |
|---|---------------------------------|
| Computer or USB DIRECT-PRINT-compatible printer | Mass Storage (USB DIRECT-PRINT) |
| PictBridge-compatible printer | PTP (PictBridge) |

- Mass Storage (USB DIRECT-PRINT) causes the camera to see the computer as an external storage device. Use this setting for normal transfer of images from the camera to a computer (using the bundled Photo Loader application).
- PTP (PictBridge) simplifies the transfer of image data to the connected device.

- 4. Use the USB cable that comes with the camera to connect the USB cradle to a printer.**

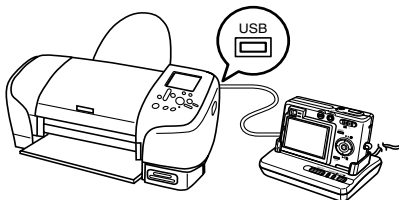

- Also, connect the AC adaptor to the USB cradle and plug the AC adaptor into an electrical outlet.
- If you are using battery power without the AC adaptor, make sure that the battery is fully charged.

- 5. Set the camera on the USB cradle.**

- 6. Turn on the printer.**

- 7. Load paper for printing the images into the printer.**

- 8. Press the USB cradle's [USB] button.**

- This displays the print menu on the camera's monitor screen.

- 9. On the print menu, select "1 Image", and then press [SET].**

- You can use [◀] and [▶] to select the image you want to print.
- You can toggle date stamping of the image on and off by pressing [DISP]. The  icon indicates that date stamping is turned on.

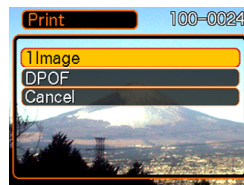

- 10. On the camera's monitor screen, use [▲] and [▼] to select "Print", and then press [SET].**

- This starts printing and displays the message "Busy.... Please wait..." on the monitor screen. The message will disappear after a short while, even though printing is still being performed. Pressing any of the camera's buttons while printing is in progress will cause the message to reappear.
- The print menu will appear when printing is complete.



- To print again, repeat the above from step 9.

11. After you are finished printing, press the USB cradle's [USB] button, and then turn off the camera.

To print a group of images

- 1. Use the DPOF procedure on page 144 to specify the images in file memory that you want to print.**
- 2. Perform steps 1 through 8 of the procedure under "To print a single image" on page 146.**
- 3. On the print menu, select "DPOF", and then press [SET].**
- 4. On the camera's monitor screen, use [▲] and [▼] to select "Print", and then press [SET].**
 - This starts printing and displays the message "Busy... Please wait..." on the monitor screen. The message will disappear after a short while, even though printing is still being performed. Pressing any of the camera's buttons while printing is in progress will cause the message to reappear.
 - The print menu will appear when printing is complete.
 - This automatically starts printing of the images you specified with the DPOF procedure.
 - To print again, repeat the above from step 3.

- A message appears on the monitor screen, followed by the DPOF setting screen (page 144), if there are no DPOF settings currently configured on the camera to control the printing operation. If this happens, configure the required DPOF settings and then perform step 6 of the above procedure again.
- If you want to change the current DPOF settings, select “DPOF” on the print menu to display the DPOF setting screen (page 144).

5. After you are finished printing, press the USB cradle’s [USB] button, and then turn off the camera.

Printing Precautions

- See the documentation that comes with your printer for information about print quality and paper settings.
- Contact your printer manufacturer for information about models that support PictBridge and USB DIRECT-PRINT, upgrades, etc.
- Never disconnect the USB cable, or perform any camera or USB cradle operation while printing is in progress. Doing so causes a printer error.

PRINT Image Matching II

Images include PRINT Image Matching II data (mode setting and other camera setup information). A printer that supports PRINT Image Matching II reads this data and adjusts the printed image accordingly, so your images come out just the way you intended when you recorded them.

* Seiko Epson Corporation holds the copyright for PRINT Image Matching and PRINT Image Matching II.



Exif Print

Exif Print is an internationally supported, open standard file format that makes it possible to capture and display vibrant digital images with accurate colors. With Exif 2.2, files include a wide range of shooting condition information that can be interpreted by an Exif Print printer to produce better-looking prints.



▶▶ IMPORTANT! ◀◀

- Information about the availability of Exif Print compatible printer models can be obtained from each printer manufacturer.

VIEWING IMAGES ON A COMPUTER

After using the USB cradle to establish a USB connection between the camera and your computer, you can use your computer to view images in file memory and copy images to your computer's hard disk or other storage media. In order to do this, you first need to install the USB driver located on the CD-ROM (CASIO Digital Camera Software) that comes bundled with the camera onto your computer. Note that the procedure you need to perform depends on whether you are using computer running under Windows (see below) or a Macintosh (see page 157).

Using the Camera with a Windows Computer

The following are the general steps for viewing and copying files from a computer running under Windows. You can find details about each operation in the procedures that follow below. Note that you should also refer to the documentation that comes with your computer for other information about USB connections, etc.

1. If you are running Windows 98, Me, or 2000, install the USB driver onto your computer.
 - You need to perform this step only once, the first time you connect to your computer.
 - If you are running Windows XP, you do not need to install the USB driver.



2. Use the USB cradle to establish a connection between the camera and computer.



3. View and copy the images you want.

►► IMPORTANT! ◀◀

- If you want to transfer files from the camera's built-in memory to a computer, make sure there is no memory card loaded in the camera before you place it into the USB cradle.
- If battery goes low while you are not using the AC adaptor, data communication may stop and the camera may shut down. Use of the special AC adaptor is recommended to power the camera during data communication.
- If you are using battery power without the AC adaptor, make sure that the battery is fully charged.

Do not try to establish a connection between the camera and computer before installing the USB driver onto the computer. If you do, the computer will not be able to recognize the camera.

- USB driver installation is required in the case of Windows 98, Me, and 2000. Do not connect the camera to a computer running one of the above operating systems without installing the USB driver first.
- USB driver installation is not required in the case of Windows XP.

1. What you should do first depends on whether your computer is running under Windows 98, Me/2000 or Windows XP.

■ Windows 98/Me/2000 Users

- Start from step 2 to install the USB driver.
- Note that the example installation presented here uses Windows 98.

■ Windows XP Users

- Installation of the USB driver is not required, so jump directly to step 6.

2. Set the bundled CD-ROM (CASIO Digital Camera Software) into the CD-ROM drive of your computer.

3. On the menu screen that appears, click "English".

4. Click [USB driver] and then [Install].

- This starts installation.
- The following steps show installation under the English version of Windows.

VIEWING IMAGES ON A COMPUTER

5. On the screen that appears after installation is complete, select the “Yes, I want to restart my computer now.” check box and then click [Finish] to restart your computer.
6. Connect the bundled AC adaptor to the [DC IN 5.3V] connector of the USB cradle, and then plug it in to a household power outlet.
 - If you are using battery power without the AC adaptor, make sure that the battery is fully charged.
 - Note that the shape of the AC adaptor depends on the area where you purchased the camera.

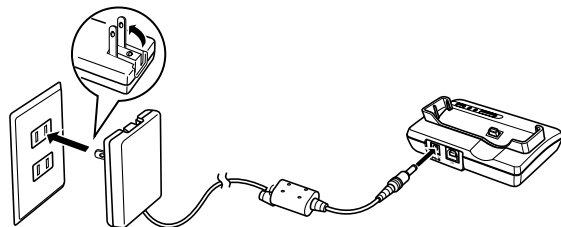
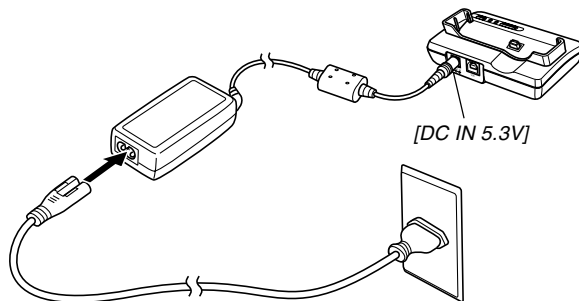

VIEWING IMAGES ON A COMPUTER

7. Connect the USB cable that comes bundled with the camera to the USB cradle and your computer's USB port.

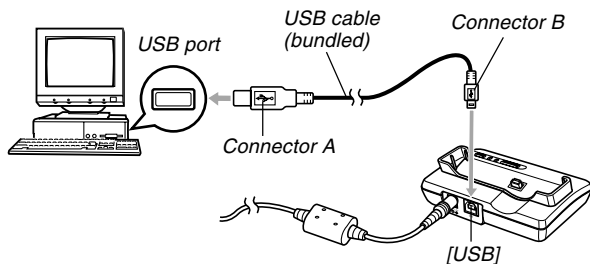

- Take care when connecting the USB cable to the USB cradle or your computer. USB ports and cable plugs are shaped for proper positioning.
- Plug the USB cable plugs into the ports securely, as far as they will go. Proper operation is not possible if connections are not correct.

8. In the REC mode or the PLAY mode, press the camera's [MENU] button.

9. Select the "Set Up" tab, select "USB", and then press [▶].

10. Use [▲] and [▼] to select "Mass Storage (USB DIRECT-PRINT)", and then press [SET].

11. After making sure the camera is turned off, place the camera onto the USB cradle.

- Do not place the camera onto the USB cradle while it is turned on.

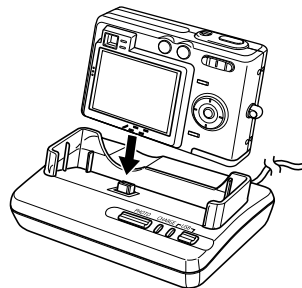

12. Press the USB cradle's [USB] button.

- This will cause the “Add New Hardware...” dialog box to appear on the computer screen as the computer automatically detects the camera's file memory. After you install the USB driver, “Add New Hardware...” dialog box will no longer appear when you perform the above steps to establish a USB connection.
- Pressing the [USB] button enters the USB mode, which causes the USB cradle's [USB] lamp to light green (page 187).
- At this point, some operating systems will display a “Removable Disk” dialog box. If your operating system does, close the dialog box.

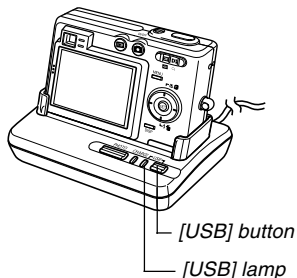

13. On your computer, double-click “My Computer”.

- If you are running Windows XP, click [Start] and then [My Computer].

14. Double-click “Removable Disk”.

- Your computer sees the camera's file memory as a removable disk.

15. Double-click the “Dcim” folder.

16. Double-click the folder that contains the image you want.

17. Double-click the file that contains the image you want to view.

- For information about file names, see “Memory Directory Structure” on page 163.

18. Depending on your operating system, perform one of the following procedures to save the files, if you want.

■ Windows 98, 2000, Me

1. In the camera's file memory (Removable Disk), right-click the "Dcim" folder.
 2. On the shortcut menu that appears, click [Copy].
 3. Double click [My Documents] to open it.
 4. On the My Documents [Edit] menu, click [Paste].
- This copies the "Dcim" folder (which contains the image files) to your "My Documents" folder.

■ Windows XP

1. In the camera's file memory (Removable Disk), right-click the "Dcim" folder.
 2. On the shortcut menu that appears, click [Copy].
 3. Click [Start] and then [My Documents].
 4. On the My Documents [Edit] menu, click [Paste].
- This copies the "Dcim" folder (which contains the image files) to your "My Documents" folder.

▶▶ IMPORTANT! ◀◀

- Never use your computer to edit, delete, move, or rename images stored in file memory. Doing so can cause problems with the image management data used by the camera, which may make it impossible to display images on the camera or it may cause a large error in the number of images value displayed by the camera. Always copy images to your computer memory before performing any edit, delete, move, or rename operation.

19. Depending on the version of Windows you are running, use one of the following procedures to terminate the USB connection.

■ Windows Me/98/XP Users

- After pressing the USB cradle's [USB] button and making sure that the [USB] lamp is not lit, remove the camera from the USB cradle.

■ Windows 2000 Users

- Click card services in the task tray on your computer screen, and disable the drive number assigned to the camera. After pressing the USB cradle's [USB] button and making sure that the [USB] lamp is not lit, remove the camera from the USB cradle.

USB Connection Precautions

- Be sure to read the documentation that comes with your computer for other important information about USB connections.
- Do not leave the same image displayed on your computer screen for a long time. Doing so can cause the image to “burn in” on the screen.
- Never disconnect the USB cable, or perform any camera or USB cradle operation while data communication is in progress. Doing so can cause data to become corrupted.

Using the Camera with a Macintosh Computer

The following are the general steps for viewing and copying files from a Macintosh.

You can find details about each operation in the procedures that follow below. Note that you should also refer to the documentation that comes with your Macintosh for other information about USB connections, etc.

►► IMPORTANT! ◀◀

- This camera does not support operation with a computer running Mac OS 8.6 or lower, or Mac OS X 10.0. If you have a Macintosh running Mac OS 9 or OS X (10.1, 10.2 or higher), use the standard USB driver that comes with your OS.

1. Use the USB cradle to establish a connection between the camera and your Macintosh.



2. View and copy the images you want.

▶▶ IMPORTANT! ◀◀

- If you want to transfer files from the camera's built-in memory to a computer, make sure there is no memory card loaded in the camera before you place it onto the USB cradle.

1. Connect the bundled AC adaptor to the [DC IN 5.3V] connector of the USB cradle, and then plug it in to a household power outlet.

- If you are using battery power without the AC adaptor, make sure that the battery is fully charged.
- Note that the shape of the AC adaptor depends on the area where you purchased the camera.

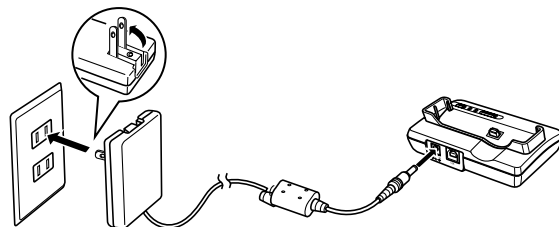
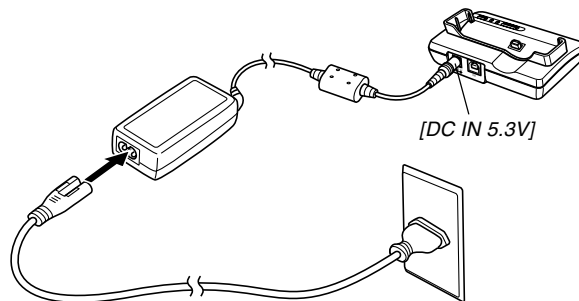

VIEWING IMAGES ON A COMPUTER

2. Connect the USB cable that comes bundled with the camera to the USB cradle and your computer's USB port.

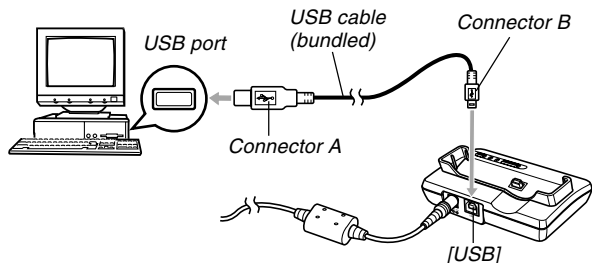

- Take care when connecting the USB cable to the USB cradle or your computer. USB ports and cable plugs are shaped for proper positioning.
- Plug the USB cable plugs into the ports securely, as far as they will go. Proper operation is not possible if connections are not correct.

3. In the REC mode or the PLAY mode, press the camera's [MENU] button.
4. Select the "Set Up" tab, select "USB", and then press [▶].
5. Use [▲] and [▼] to select "Mass Storage (USB DIRECT-PRINT)", and then press [SET].
6. After making sure the camera is turned off, place the camera onto the USB cradle.
 - Do not place the camera onto the USB cradle while it is turned on.

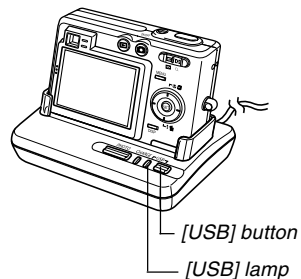

7. Press the USB cradle's [USB] button.

- Pressing the [USB] button enters the USB mode, which causes the USB cradle's [USB] lamp to light green (page 187).

8. Your Macintosh will see the camera's file memory as a drive.

- The appearance of the drive icon depends on the Mac OS version you are using.
- After installing the USB driver, your Macintosh will see the camera's file memory as a drive whenever you establish a USB connection between them.

9. Double-click the drive icon for the camera's file memory, the "DCIM" folder, and then the folder that contains the image you want.

10. Double-click the file that contains the image you want to view.

- For information about file names, see "Memory Directory Structure" on page 163.

11. To copy all the files in file memory to your Macintosh hard disk, drag the "DCIM" folder to the folder to which you want to copy it.

▶▶ IMPORTANT! ◀◀

- Never use your computer to edit, delete, move, or rename images stored in file memory. Doing so can cause problems with the image management data used by the camera, which may make it impossible to display images on the camera or it may cause a large error in the number of images value displayed by the camera. Always copy images to your computer memory before performing any edit, delete, move, or rename operation.

12. To terminate the USB connection, drag the drive icon that represents the camera to Trash. After pressing the USB cradle's [USB] button and making sure that the [USB] lamp is not lit, remove the camera from the USB cradle.

USB Connection Precautions

- Be sure to read the documentation that comes with your computer for other important information about USB connections.
- Do not leave the same image displayed on your computer screen for a long time. Doing so can cause the image to “burn in” on the screen.
- Never disconnect the USB cable, or perform any camera or USB cradle operation while data communication is in progress. Doing so can cause data to become corrupted.

Operations You Can Perform from Your Computer

The following are the operations you can perform while there is a USB connection between your camera and computer. See the referenced pages for more information about each operation.

- View images in album format
.... See “Using the Album Feature” on page 166.
- Print images in album format
.... See “Using the Album Feature” on page 166.
- Automatically transfer images to your computer and manage images
.... See “Installing the Software from the CD-ROM” on page 174 for information about installing Photo Loader.
- Retouch images
.... See “Installing the Software from the CD-ROM” on page 174 for information about installing Photohands.

Using a Memory Card to Transfer Images to a Computer

The procedures in this section describe how to transfer images from the camera to your computer using a memory card.

Using a Computer with a Built-in SD Memory Card Slot

Insert the SD memory card directly into the slot.

Using a Computer with a Built-in PC Card Slot

Use a commercially available PC card adapter (for an SD memory card/MMC). For full details, see the user documentation that comes with the PC card adapter and your computer.

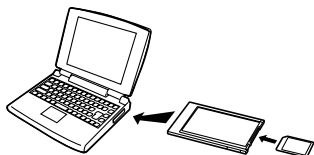

Using a Commercially Available SD Memory Card Reader/Writer

See the user documentation that comes with the SD memory card reader/writer for details about how to use it.

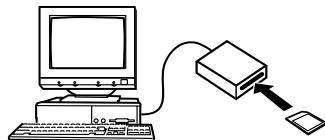

Using a Commercially Available PC Card Reader/Writer and PC Card Adapter (for SD Memory Cards and MMCs)

See the user documentation that comes with the PC card reader/writer and PC card adapter (for an SD memory card/MMC) for details about how to use them.

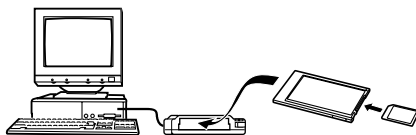

Memory Data

Images recorded with this camera and other data are stored in memory using DCF (Design rule for Camera File System) protocol. DCF protocol is designed to make it easier to exchange image and other data between digital cameras and other devices.

DCF Protocol

DCF devices (digital cameras, printers, etc.) can exchange images with each other. DCF protocol defines camera format for image file data and the directory structure for file memory, so images can be viewed using another manufacturer's DCF camera or printed on a DCF printer.

Memory Directory Structure

■ Directory Structure

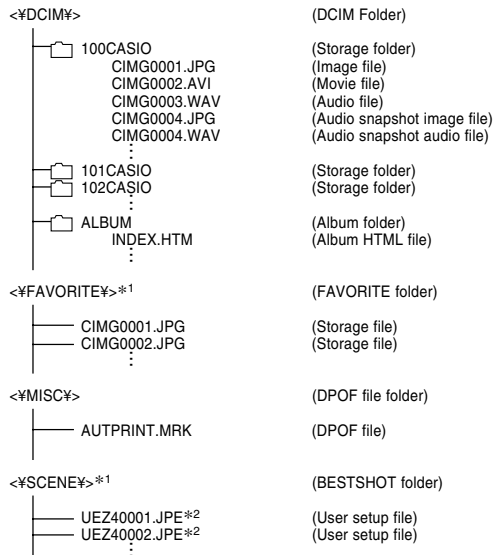

*1 These folders are created in built-in memory only.

*2 These file names are part of the EX-Z40 file structure only.
With the EX-Z30, files are named UEZ30001.JPE, UEZ30002.JPE, etc.

■ Folder and File Contents

- DCIM folder
Folder that stores all of the digital camera files
- Storage folder
Folder for storing files created by the digital camera
- Image file
File that contains an image recorded with the digital camera (File Name Extension: JPG)
- Movie file
File that contains a movie recorded with the digital camera (File Name Extension: AVI)
- Audio file
File that contains an audio recording (File Name Extension: WAV).
- Audio snapshot image file
File that contains the image part of an audio snapshot (File Name Extension: JPG).
- Audio snapshot audio file
File that contains the audio part of an audio snapshot (File Name Extension: WAV).
- Album folder
Folder that contains files used by the album function
- Album HTML file
File used by the album function (File Name Extension: HTM)
- FAVORITE folder
Folder that contains Favorites image files (Image Size: 320 x 240 pixels)
- DPOF file folder
Folder that contains DPOF files
- BESTSHOT folder (Built-in memory only)
Folder that contains BESTSHOT user setup files.
- User setup files (Built-in memory only)
Files that contain BESTSHOT user setups

Image Files Supported by the Camera

- Image files recorded with the CASIO EX-Z30/EX-Z40 Digital Camera
- DCF protocol image files

Certain DCF functions may not be supported. When displaying an image recorded on another camera model, it may take a long time for the image to appear on the display.

Built-in Memory and Memory Card Precautions

- Note that the folder named “DCIM” is the parent (top) folder of all the files in memory. When transferring memory contents to a hard disk, CD-R, MO disk, or other external storage, treat all the contents inside a DCIM folder as a set and always keep them together. You can change the name of the DCIM folder on your computer. Changing the name to a date is a good way to keep track of multiple DCIM folders. However, if you even want to copy the folders back to the camera’s file memory, be sure you change the name of the DCIM folder back to “DCIM” first. The camera does not recognize any folder name other than DCIM.

USING THE CAMERA WITH A COMPUTER

The album feature of the camera creates files that make it possible for you to view images on your computer in a photo album layout. You can also use the applications contained on the CD-ROM that comes bundled with the camera to automate image transfer and to retouch images.

Using the Album Feature

The album feature creates an HTML photo album layout that displays your images. You can use the HTML layout to post your images on a Web page, or for printing the images.

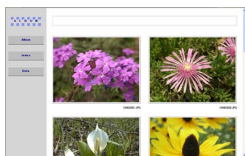

Album



Index



Info

- You can use the Web browser shown below to view or print the contents of an album. Note that to view a movie on a computer running Windows 2000 or 98, you need to install DirectX.

Microsoft Internet Explorer Ver 5.5 or later

Creating an album

▶▶ IMPORTANT! ◀◀

- Remember that creating an “ALBUM” folder (page 163) causes different size versions of each image to be created in memory. If there is an “ALBUM” folder in image memory when you specify printing of all images by a professional print service or on a printer, you may end up with unwanted multiple prints of the same image. To avoid this problem, use the procedure under “To delete an album” on page 174 to delete the ALBUM folder.

1. In the **PLAY** mode, press **[MENU]**.

2. Select the **“PLAY”** tab, select **“Create Album”**, and then press **[▶]**.

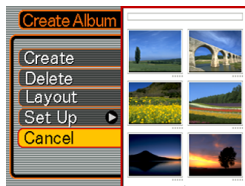

Sample layout

3. Use **[▲]** and **[▼]** to select **“Create”**, and then press **[SET]**.

- This starts creation of the album, and causes the message “Busy.... Please wait...”. to appear on the monitor screen.
- The **PLAY** mode screen reappears after creation of the album is complete.
- Creating an album causes a file folder named **“ALBUM”**, which contains a file named **“INDEX.HTM”** plus other files to be created in camera memory or on the memory card.

▶▶ IMPORTANT! ◀◀

- Never open the battery compartment cover or remove the memory card from the camera while an album is being created. Doing so not only runs the risk of certain album files being skipped, it can also result in image data and other data in memory being corrupted.
- If memory becomes full while an album is being created, the message **“Memory Full”** appears on the monitor screen and album creation is terminated.
- Album creation will not be performed properly if the battery goes dead while album creation is in progress.
- You can also configure the camera to create albums automatically (page 170). However, performing the above procedure creates an album regardless of whether automatic album creation is turned on or off.
- Images in the **“ALBUM”** folder (page 163) cannot be viewed on the camera’s monitor screen.

Selecting an Album Layout

You can select from among 10 different display layouts for an album.

1. In the **PLAY** mode, press [MENU].
2. Select the “**PLAY**” tab, select “**Create Album**”, and then press [▶].
3. Use [▲] and [▼] to select “**Layout**”.
4. Use [◀] and [▶] to select the layout you want.
 - Changing the layout causes the layout sample on the right side of the screen to change.

▶▶ IMPORTANT! ◀◀

- The sample layout shows the arrangement of items and the background color. It does not show whether the layout uses a list view or detailed view, or the current Image Type setting.

Configuring Detailed Album Settings

1. In the **PLAY** mode, press [MENU].
2. Select the “**PLAY**” tab, select “**Create Album**”, and then press [▶].
3. Use [▲] and [▼] to select “**Set Up**”, and then press [▶].
4. Use [▲] and [▼] to select the item whose setting you want to change, and then press [▶].
 - Details about each of the settings are provided in the following sections.
5. Use [▲] and [▼] to change the setting, and then press [SET].



■ Background Color

You can specify white, black, or gray as the color of the album background using the procedure under “Configuring Detailed Album Settings”.

■ Album Type

There are two album types: “Normal” and “Index/Info”.

“Normal” Type : This type of album displays images in accordance with the currently selected layout.

“Index/Info” Type : In addition to the normal album screen, this type of album also includes thumbnails of images and detailed information about each image.

■ Image Use

This setting lets you select from among three different image uses, as described below. Select the image use that best suits the way you plan to use the image.

| For this purpose: | Select this setting: |
|--|----------------------|
| <p>Smaller images for album browsing, Website thumbnails, or archiving on a CD-R or other media, with the full-size image displayed when a thumbnail is clicked</p> <ul style="list-style-type: none"> This setting can be used for browsing with the thumbnails. Clicking a thumbnail displays a larger version for viewing or printing. | View |
| <p>Small image files only for album browsing, or uploading to a Website, etc.</p> <ul style="list-style-type: none"> This option displays only the small-file images (located in the camera’s “ALBUM” folder). Smaller files upload to the Internet faster. You cannot enlarge images by clicking a thumbnail or play movies while this image is selected. | WEB |
| <p>Printing (high resolution)</p> <ul style="list-style-type: none"> High-resolution images take longer to display on your computer screen. You cannot enlarge images by clicking a thumbnail or play movies while this image is selected. | Print |

■ Auto Album Creation On/Off

This setting controls whether an album is created automatically whenever you turn off the camera.

| To do this: | Select this option: |
|------------------------------|---------------------|
| Turn on auto album creation | On |
| Turn off auto album creation | Off |

- When auto album creation is turned on, an album is created automatically in built-in memory or on the memory card whenever you turn off the camera.

»» IMPORTANT! ««

- When you turn off the camera while auto album creation is turned on, the monitor screen turns off, but the green operation lamp continues to flash for a few seconds to indicate that the album creation process is being performed. Never open the battery compartment cover or remove the memory card while the green operation lamp is flashing.

»» NOTE ««

- Depending on the number of images in memory, it can take quite a bit of time to complete auto album creation when you turn off the camera. If you do not plan to use the album feature, we suggest that you keep auto album creation turned off, which shortens the amount of time the camera takes to power down completely.

Viewing Album Files

You can view and print album files using your computer's Web browser application.

1. Use your computer to access the data in built-in memory or on the memory card, or access a memory card with your computer (pages 151, 162).
2. Open the built-in memory "ALBUM" folder or the memory card "ALBUM" folder, which is located inside the folder named "DCIM".
3. Use your computer's Web browser to open the file named "INDEX.HTM".

- This displays a list of folders in built-in memory or on the memory card.

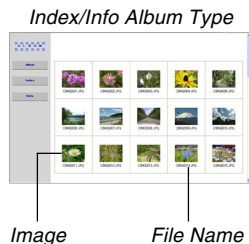

4. If you created the album after selecting "Index/Info" as the album type under "Configuring Detailed Album Settings" on page 168, you can click one of the following display options.

Album : Displays an album created by the camera.

Index : Displays a list of images stored in a folder.

Info : Displays information about each image.

- If "View" is selected for "Use" (page 169), you can double-click an image on your computer screen to display the full-size version.

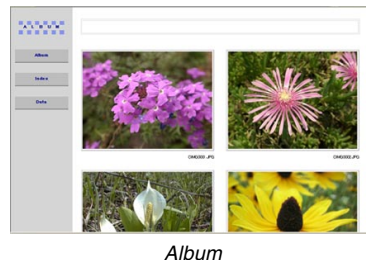

USING THE CAMERA WITH A COMPUTER



Index

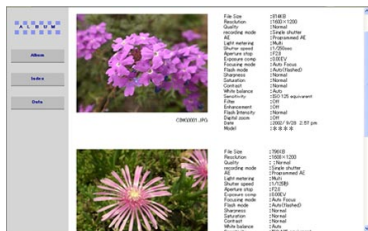

Info

- The following describes the information that appears on the Info Screen.

| This Info Screen item: | Shows this: |
|------------------------|-------------------------|
| File Size | Image file size |
| Resolution | Resolution |
| Quality | Quality |
| Recording mode | Recording mode |
| AE | Exposure mode |
| Light metering | Metering mode |
| Shutter speed | Shutter speed |
| Aperture stop | Aperture stop |
| Exposure comp | EV shift |
| Focusing mode | Focusing mode |
| AF Area | Auto Focus area |
| Flash mode | Flash mode |
| Sharpness | Sharpness |
| Saturation | Saturation |
| Contrast | Contrast |
| White balance | White balance |
| Sensitivity | Sensitivity |
| Filter | Filter setting |
| Enhancement | Enhancement setting |
| Flash intensity | Flash intensity |
| Digital zoom | Digital zoom setting |
| World | Location |
| Date | Recording date and time |
| Model | Camera model name |

»» NOTES ««

- When printing an album page, you should set up your Web browser as described below.
 - Select the browser frame where the images are located.
 - Set margins to the lowest possible values.
 - Set the background color to a printable color.
- See the user documentation that came with your Web browser application for details about printing and configuring settings for printing.
- Album contents (titles, comments, etc.) cannot be edited on the camera. Use a commercially available HTML file editor to edit album contents.

5. After you are finished viewing the album, exit your Web browser application.

Saving an Album

- To save an album, copy the “DCIM” folder from camera memory or the memory card to your computer’s hard disk, a CD-R, an MO disk, or some other storage medium. Note that copying only the “ALBUM” folder, does not copy image data and other necessary files.
- After copying the “DCIM” folder, do not change or delete any of the files inside of it. Adding new images or deleting existing images may lead to abnormal album display.
- If you plan to use a memory card again after saving its album, first delete all of its files or format it before loading it into the camera.
- When you have “WEB” selected for the “Use” setting, the album shows only the smaller image files stored in the “ALBUM” folder. Such images can be uploaded to the Internet more quickly.

To delete an album

1. In the **PLAY** mode, press **[MENU]**.
2. Select the **“PLAY”** tab, select **“Create Album”**, and then press **[▶]**.
3. Use **[▲]** and **[▼]** to select **“Delete”**, and then press **[SET]**.
 - The camera returns to the **PLAY** mode after the album is deleted.

Installing the Software from the CD-ROM

Your digital camera comes bundled with useful applications for using it in combination with a computer. Install the applications you need on your computer.

About the bundled CD-ROM (CASIO Digital Camera Software)

The CD-ROM (CASIO Digital Camera Software) that comes bundled with the camera contains the applications described below. Installation of these applications is optional, and you should install only the ones you want to use.

USB Driver for Mass Storage (for Windows)

This is the software that makes it possible for the camera to “talk” to your personal computer over a USB connection. If you are using Windows XP, do not install the USB driver from the CD-ROM. With these operating systems, you will be able to perform USB communication simply by connecting the camera to your computer with the USB cable.

Photo Loader (for Windows/Macintosh)

This application automatically transfers image, audio snapshot, and voice recording WAV files from the camera to your computer. Photo Loader automatically stores transferred files in folders named using the current date (year, month, day) and generates HTML files that make it possible to view images using a web browser. Photo Loader (Windows version only) also includes a feature that simplifies the task of attaching images to e-mail.

* See the user documentation file (PDF) on the bundled “CASIO Digital Camera Software” CD-ROM for details about using Photo Loader.

Photohands (for Windows)

Photohands includes retouching tools for adjusting image color, contrast, and brightness, for resizing images, for changing image orientation, and for cropping images. You can also use Photohands for printing images and for adding a date stamp to printed images.

* See the user documentation file (PDF) on the bundled “CASIO Digital Camera Software” CD-ROM for details about using Photohands.

DirectX (for Windows)

This software provides an extended tool set including a codec that allows Windows 98 and 2000 to handle movie files recorded using a digital camera. You do not need to install DirectX if you are running Windows XP or Me.

Acrobat Reader (for Windows)

This is an application that lets you read PDF files. Use it to read the user documentation for the camera, Photo Loader, and Photohands, all of which is included on the bundled CD-ROM.

* See the user documentation files (PDF) on the bundled CD-ROM for details about using Photo Loader and Photohands. See “Viewing User Documentation (PDF files)” on page 179 (Windows) and page 181 (Macintosh) of this manual for more information.

Computer System Requirements

Computer system requirements depend on each of the applications, as described below.

Windows

| | USB Driver*1 | Photo Loader | Photohands |
|--------|-------------------------------------|-------------------------------------|-------------------|
| OS | XP*2/2000/Me/98 | XP/2000/Me/98 | XP/2000/Me/98 |
| CPU | 486 or higher (Pentium recommended) | 486 or higher (Pentium recommended) | Pentium or higher |
| Memory | – | At least 16MB | At least 64MB |
| HD | – | At least 7MB | At least 10MB |

*1 In the case of Windows 2000, you install a data file that enables use of the operating system's standard USB driver. You do not install a special USB driver. Proper operation is not guaranteed on a computer that has been upgraded from Windows 95 or 3.1 to Windows Me or 98, or from Windows 95 or NT to Windows 2000.

*2 With Windows XP, use the USB driver that comes with the operating system. You do not need to install the USB driver that comes with the camera.

Macintosh

| | Photo Loader |
|--------|---------------|
| OS | 9 |
| CPU | Power PC |
| Memory | At least 32MB |
| HD | At least 3MB |

- USB connection is supported on a Macintosh running OS 9, 10.1, or 10.2. Operation is supported using the standard USB driver that comes with the operating system, so all you need to do is connect the camera to your Macintosh using the USB cable.

▶▶ IMPORTANT! ◀◀

- For details about Windows minimum system requirements, see the “Readme” file on the CD-ROM (CASIO Digital Camera Software) that comes bundled with the camera.
- For details about Macintosh minimum system requirements, use a Web browser application to read the contents of the “readme” file on the CD-ROM (CASIO Digital Camera Software) that comes bundled with the camera.
- The software on the CD-ROM (CASIO Digital Camera Software) that comes bundled with the camera does not support operation under Mac OS X (10.0).

Installing Software from the CD-ROM in Windows

Use the procedures in this section to install the software from the bundled CD-ROM (CASIO Digital Camera Software) to your computer.

▶▶ NOTE ◀◀

- If you already have one of the bundled applications installed on your computer, check its version. If the bundled version is newer than the one you have, you should install the newer version.

The CD-ROM (CASIO Digital Camera Software) includes the software and user documentation for various languages. Check the CD-ROM menu screen to see if applications and user documentation are available for a particular language.

Getting Started

Start up your computer and insert the CD-ROM into its CD-ROM drive. This will automatically launch the menu application, which displays a menu screen on your computer.

- The menu application may not start up automatically on some computers. If this happens, navigate to the CD-ROM and double-click “menu.exe” to launch the menu application.

Selecting a Language

First select a language. Note that some software is not available in all languages.

- 1. On the menu screen, click the tab for the language you want.**

Viewing the Contents of the “Read me” File

You should always read the “Read me” file for any application before installing it. The “Read me” file contains information you need to know when installing the application.

- 1. Click the “Read me” button for the application you are going to install.**

►► IMPORTANT! ◀◀

- Before upgrading or reinstalling Photo Loader, or before installing it onto another computer, be sure to read the “Read me” file for information about retaining existing libraries.

Installing an Application

1. Click the “Install” button for the application you want to install.
2. Follow the instructions that appear on your computer screen.

»» IMPORTANT! ««

- Be sure to follow the instructions carefully and completely. If you make a mistake when installing Photo Loader, you may not be able to browse your existing library information and HTML files that are created automatically by Photo Loader. In some cases, image files may be lost.
- When using an operating system other than Windows XP, never connect the camera to your computer without installing the USB driver from the CD-ROM first.

Viewing User Documentation (PDF Files)

1. In the “Manual” area, click the name of the manual you want to read.

»» IMPORTANT! ««

- You need to have Adobe Acrobat Reader installed on your computer to read user documentation files. If you do not already have Adobe Acrobat Reader installed, you can install it from the bundled CD-ROM.

User Registration

You can perform user registration over the Internet. To do so, of course, you need to be able to connect to the Internet with your computer.

1. Click the “Register” button.

- This starts up your Web browser and accesses the user registration website. Follow the instructions that appear on your computer screen to register.

2. After registering, terminate your connection to the Internet.

Exiting the Menu Application

1. On the menu screen, click “Exit” to exit the menu.

Installing Software from the CD-ROM on a Macintosh

Use the procedures in this section to install the software from the bundled CD-ROM (CASIO Digital Camera Software) to your computer.

Installing Software

Use the following procedures to install the software.

■ To install Photo Loader

1. Open the folder named “Photo Loader”.
2. Open the folder named “English”, and then open the file named “Important”.
3. Open the folder named “Installer”, and then open the file named “readme”.
4. Follow the instructions in the “readme” file to install Photo Loader.

▶▶ IMPORTANT! ◀◀

- If you are upgrading to the new version of Photo Loader from a previous version and you want to use library management data and HTML files created using the old version of Photo Loader, be sure to read the “Important” file in the “Photo Loader” folder. Follow the instructions in the file to use your existing library management files. Failure to follow this procedure correctly can result in loss or corruption of your existing files.

Viewing User Documentation (PDF Files)

To perform the following procedures, you must have Acrobat Reader installed on your Macintosh. You can download the latest version of Adobe Acrobat Reader by visiting the Adobe Systems website.

■ To view the camera user’s guide

1. On the CD-ROM, open the “Manual” folder.
2. Open the “Digital Camera” folder, and then open the folder for the language whose user’s guide you want to view.
3. Open the file named “camera_xx.pdf”.
 - “xx” is the language code.

■ **To read the Photo Loader user's guide**

1. On the CD-ROM, open the "Manual" folder.
2. Open the "Photo Loader" folder and then open the "English" folder.
3. Open "PhotoLoader_english".

■ **To register as a user**

Internet registration only is supported. Visit the following CASIO website to register:

<http://world.casio.com/qv/register/>

APPENDIX

Menu Reference

The following shows lists of menus that appear in the REC mode and PLAY mode, and their settings.

- The settings that are underlined in the following table are initial defaults.

■ REC mode

● REC tab menu

| | |
|---------------|--|
| REC Mode | Snapshot / BESTSHOT / Movie / Voice |
| Self-timer | 10 sec / 2 sec / X3 / <u>Off</u> |
| Size | EX-Z30: <u>2048 x 1536</u> / 2048 x 1360 (3:2) / 1600 x 1200 / 1280 x 960 / 640 x 480 EX-Z40: <u>2304 x 1728</u> / 2304 x 1536 (3:2) / 1600 x 1200 / 1280 x 960 / 640 x 480 |
| Quality | Fine / <u>Normal</u> / Economy |
| EV Shift | -2.0 / -1.7 / -1.3 / -1.0 / -0.7 / -0.3 / <u>0.0</u> / +0.3 / +0.7 / +1.0 / +1.3 / +1.7 / +2.0 |
| White Balance | <u>Auto</u> / (Sunlight) / (Overcast) / (Shade) / (Light Bulb) / (Fluorescent) / Manual |

| | |
|--------------|--|
| ISO | EX-Z30: <u>AUTO</u> / ISO 50 / ISO 100/ ISO 200 / ISO 400 EX-Z40: <u>AUTO</u> / ISO 50 / ISO 100/ ISO 200 / ISO 400 |
| AF Area | <u>Spot</u> / Multi |
| Auto PF | <u>On</u> / Off |
| Grid | On / <u>Off</u> |
| Digital Zoom | <u>On</u> / Off |
| Review | <u>On</u> / Off |
| L/R Key | <u>REC Mode</u> / EV shift / White Balance / ISO / Self-timer / Off |

● Memory tab menu

| | |
|---------------|-----------------|
| REC Mode | <u>On</u> / Off |
| Flash | <u>On</u> / Off |
| Focus | On / <u>Off</u> |
| White Balance | On / <u>Off</u> |
| ISO | On / <u>Off</u> |
| AF Area | <u>On</u> / Off |
| Digital Zoom | <u>On</u> / Off |
| MF Position | On / <u>Off</u> |
| Zoom Position | On / <u>Off</u> |

● Set Up tab menu

| | |
|----------------|--|
| Sounds | <u>Startup</u> / Half Shutter / Shutter / Operation / Volume |
| Startup | On (Selectable image) / <u>Off</u> |
| File No. | <u>Continue</u> / Reset |
| World Time | <u>Home</u> / World Home Time setup (city, DST, etc.) World Time setup (city, DST, etc.) |
| Date Style | YY/MM/DD / DD/MM/YY / MM/DD/YY |
| Adjust | Time setting |
| Language | 日本語 / English / Français / Deutsch / Español / Italiano / Português / 中國語 / 中国語 / 한국어 |
| Sleep | 30 sec / <u>1 min</u> / 2 min / Off |
| Auto Power Off | <u>2 min</u> / 5 min |
| REC / PLAY | <u>Power On</u> / Power On/Off / Disable |
| USB | <u>Mass Storage (USB DIRECT- PRINT)</u> / PTP (PictBridge) |
| Format | Format / <u>Cancel</u> |
| Reset | Reset / <u>Cancel</u> |

■ PLAY mode

● PLAY tab menu

| | |
|--------------|---|
| Slideshow | <u>Start</u> / Images / Time / Interval / Cancel |
| Favorites | <u>Show</u> / Save / Cancel |
| DPOF | <u>Select images</u> / All images / Cancel |
| Protect | <u>On</u> / All Files : On / Cancel |
| Rotation | <u>Rotate</u> / Cancel |
| Resize | <u>1280 x 960</u> / 640 x 480 / Cancel |
| Trimming | – |
| Dubbing | – |
| Create Album | Create / Delete / Layout / Set Up / <u>Cancel</u> |
| Alarm | Alarm setups |
| Copy | <u>Built-in</u> → Card / Card → Built-in / Cancel |

● Set Up tab menu

| | |
|----------------|---|
| Sounds | <u>Startup</u> / Half Shutter / Shutter / Operation / Volume |
| Startup | On (Selectable image) / <u>Off</u> |
| File No. | <u>Continue</u> / Reset |
| World Time | <u>Home</u> / World |
| | Home Time setup (city, DST, etc.) |
| | World Time setup (city, DST, etc.) |
| Date Style | YY/MM/DD / DD/MM/YY / MM/DD/YY |
| Adjust | Time setting |
| Language | 日本語 / English / Français / Deutsch / Español / Italiano / Português / 中國語 / 中国語 / 한국어 |
| Sleep | 30 sec / <u>1 min</u> / 2 min / Off |
| Auto Power Off | <u>2 min</u> / 5 min |
| REC / PLAY | <u>Power On</u> / Power On/Off / Disable |
| USB | <u>Mass Storage (USB DIRECT- PRINT)</u> / PTP (PictBridge) |
| Format | Format / <u>Cancel</u> |
| Reset | Reset / <u>Cancel</u> |

Indicator Lamp Reference

The camera has three indicator lamps: a green operation lamp, a red operation lamp, and a self-timer lamp. These lamps light and flash to indicate the current operational status of the camera.

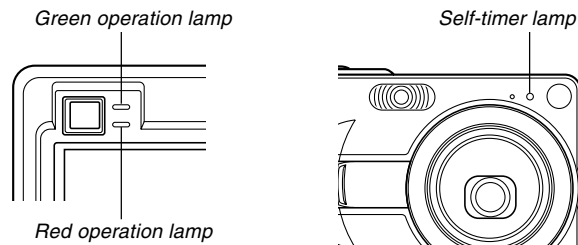

* There are three lamp flash patterns. Pattern 1 flashes once per second, Pattern 2 flashes twice per second, and Pattern 3 flashes four times per second. The table below explains what each flash pattern indicates.

REC mode

| Operation Lamp | | Self-timer Lamp | Meaning |
|----------------|-----------|-----------------|--|
| Green | Red | Red | |
| Lit | | | Operational (Power on, recording enabled) |
| | Pattern 3 | | Flash is charging. |
| | Lit | | Flash charging is complete. |
| Lit | | | Auto Focus operation was successful. |
| Pattern 3 | | | Cannot Auto Focus. |
| Lit | | | Monitor screen is off. |
| Pattern 2 | | | Storing image |
| Pattern 1 | | | Storing movie / performing noise reduction |
| | | Pattern 1 | Self-timer countdown (10 to 3 seconds) |
| | | Pattern 2 | Self-timer countdown (3 to 0 seconds) |
| | Pattern 1 | | Cannot charge flash. |
| | Pattern 2 | | Memory card problem / Memory card is unformatted. / BESTSHOT setup cannot be registered. |
| | Lit | | Memory card is locked. / Cannot create folder. / Memory is full. / Write error |

| Operation Lamp | | Self-timer Lamp | Meaning |
|----------------|-----------|-----------------|-------------------|
| Green | Red | Red | |
| | Pattern 3 | | Low battery alert |
| Pattern 3 | | | Formatting card |
| Pattern 3 | | | Powering down |

▶▶▶ IMPORTANT! ◀◀◀

- When you are using a memory card, never remove the card from the camera while the green operation lamp is flashing. Doing so will cause recorded images to be lost.

PLAY mode

| Operation Lamp | | Self-timer Lamp | Meaning |
|----------------|-----------|-----------------|---|
| Green | Red | Red | |
| Lit | | | Operational (Power on, recording enabled) |
| Pattern 3 | | | One of the following operations is being performed: delete, DPOF, image protect, copy, album creation, format, power down |
| | Pattern 2 | | Memory card problem / Memory card is unformatted. |
| | Lit | | Memory card is locked. / Cannot create folder. / Memory is full. |
| | Pattern 3 | | Low battery alert |

USB Cradle Indicator Lamps

The USB cradle has two indicator lamps: a [CHARGE] lamp and a [USB] lamp. These lamps light and flash to indicate the current operational status of the USB cradle and camera.

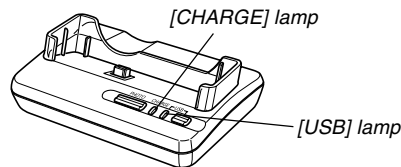



| [CHARGE] lamp | | [USB] lamp | | Meaning |
|---------------|----------|------------|----------|-------------------|
| Color | Status | Color | Status | |
| Red | Lit | | | Charging |
| Green | Lit | | | Charging complete |
| Amber | Lit | | | Charge standby |
| Red | Flashing | | | Charge error |
| | | Green | Lit | USB connection |
| | | Green | Flashing | Accessing memory |

Troubleshooting Guide

| | Symptom | Possible Cause | Action |
|-----------------|---|---|--|
| Power Supply | Power does not turn on. | <ol style="list-style-type: none"> 1) The battery is not oriented correctly. 2) The battery is dead. | <ol style="list-style-type: none"> 1) Orient the battery correctly (page 26). 2) Charge the battery (page 28). If the battery goes dead soon after being charged, it means the battery has reached the end of its life and needs to be replaced. Purchase a separately available NP-40 rechargeable lithium ion battery. |
| | Camera suddenly powers down. | <ol style="list-style-type: none"> 1) Auto Power Off activated (page 38). 2) The battery is dead. | <ol style="list-style-type: none"> 1) Turn power back on. 2) Charge the battery (page 28). |
| Image Recording | Image is not recorded when the shutter release button is pressed. | <ol style="list-style-type: none"> 1) The camera is in the PLAY mode. 2) Flash unit is being charged. 3) Memory is full. | <ol style="list-style-type: none"> 1) Press  (REC) to enter the REC mode. 2) Wait until the flash unit finishes charging. 3) Transfer files you want to keep to your computer and then delete files from image memory, or use a different memory card. |
| | Auto Focus does not focus properly | <ol style="list-style-type: none"> 1) The lens is dirty. 2) The subject is not located in the center of the focus frame when you compose the image. 3) The subject you are shooting is a type that is not compatible with Auto Focus operation (page 49). 4) You are moving the camera. | <ol style="list-style-type: none"> 1) Clean the lens. 2) Make sure the subject is centered in the focus frame when composing the image. 3) Use manual focus (page 65). 4) Mount the camera on a tripod. |

APPENDIX

| | Symptom | Possible Cause | Action |
|-----------------|--|--|---|
| Image Recording | The subject is out of focus in the recorded image. | The image is not focused properly. | When composing the image, make sure the subject on which you want to focus is located inside the focus frame. |
| | The flash does not fire. | <ol style="list-style-type: none"> 1)  (flash off) is selected as the flash mode. 2) The battery is dead. 3) The camera is in the Movie mode. 4) A scene that selects  (flash off) as the flash mode is selected in the BESTSHOT Mode. | <ol style="list-style-type: none"> 1) Select a different flash mode (page 53). 2) Charge the battery (page 28). 3) Select a different recording mode. 4) Select a different flash mode (page 53) or BESTSHOT scene (page 71). |
| | Camera powers down during self-timer countdown. | The battery is dead. | Charge the battery (page 28). |
| | Monitor screen image is out of focus. | <ol style="list-style-type: none"> 1) You are using the Manual Focus Mode and have not focused the image. 2) You are trying to use the Macro Mode when shooting a scenery or portrait shot. 3) You are trying to use Auto Focus or the Infinity Mode (∞) when shooting a close-up shot. | <ol style="list-style-type: none"> 1) Focus the image (page 65). 2) Use Auto Focus for scenery and portrait shots. 3) Use the Macro Mode for close-ups. |
| | Recorded images are not saved in memory. | <ol style="list-style-type: none"> 1) Camera powers down before the save operation is complete. 2) Removing the memory card before the save operation is complete. | <ol style="list-style-type: none"> 1) When the battery indicator shows , charge the battery as soon as possible (page 28). 2) Do not remove the memory card before the save operation is complete. |

APPENDIX

| | Symptom | Possible Cause | Action |
|----------|---|--|--|
| Playback | Color of the playback image is different from the image on the monitor screen during recording. | Sunlight or light from another source is shining directly into the lens during recording. | Position the camera so sunlight does not shine directly into the lens. |
| | Images are not displayed. | A memory card with non-DCF images recorded with another camera is loaded in the camera. | This camera cannot display non-DCF images recorded onto a memory card using another digital camera. |
| Other | All buttons and switches are disabled. | Circuit problem caused by electrostatic charge, impact, etc. while the camera was connected to another device. | Remove the battery from the camera, reinsert it, and then try again. |
| | Monitor screen is off. | <ol style="list-style-type: none"> 1) USB communication is in progress. 2) The monitor screen is turned off (in the REC mode). | <ol style="list-style-type: none"> 1) After the computer stops accessing camera file memory, press the [USB] button on the USB cradle. Check to make sure that the [USB] lamp on the USB cradle is off, and then remove the camera from the USB cradle. 2) Press [DISP] to turn on the monitor screen. |
| | Cannot transfer files over a USB connection. | <ol style="list-style-type: none"> 1) Camera is not set securely on the USB cradle. 2) USB cable is not connected securely. 3) USB driver is not installed. 4) Camera is turned off. | <ol style="list-style-type: none"> 1) Check the connection between the camera and USB cradle. 2) Check all connections. 3) Install the USB driver on your computer (page 151). 4) Press the [USB] button on the USB cradle. |

■ If you have problems installing the USB driver...

You may not be able to install the USB driver properly if you use the USB cable to connect the camera to a computer running Windows 98 before installing the USB driver from the bundled CD-ROM (CASIO Digital Camera Software), or if you have another type of driver installed. This will make it impossible for the computer to recognize the digital camera when it is connected. If this happens, you will need to re-install the camera's USB driver. For information about how to re-install the USB driver, see the USB driver's "Read me" file on "CASIO Digital Camera Software" CD-ROM that comes bundled with the camera.

Display Messages

Alarm setting complete. This message appears after you change the alarm setting.

Battery is low. The battery is dead.

Can not find the file. The camera cannot find the image specified by the slideshow "Images" setting. Specify another image (page 104).

Cannot register any more files.

- You are attempting to register a BESTSHOT setup when the "SCENE" folder already contains 999 setups.
- You are attempting to register a FAVORITE file when the "FAVORITE" folder already contains 9999 files.

Card ERROR Some problem occurred with the memory card. Turn off the camera, and remove and then reinsert the memory card. If the same message appears, format the memory card (page 138).

»» IMPORTANT! ««

Formatting the memory card deletes all files on the memory card. Before formatting, try transferring recoverable files to a computer or some other storage device.

File could not be saved because battery is low. The battery is dead, so the recorded image could not be saved.

Folder cannot be created. This message appears when you try to record an image while there are 9,999 files stored in the 999th folder. If you want to record more files, delete files you no longer need (page 112).

LENS ERROR If the lens comes into contact with some obstacle while it is extending, this message appears, the lens retracts, and the camera turns off. Take action to remove the obstacle, and try turning on power again.

Memory Full Memory is full. If you want to record more files, delete files you no longer need (page 112).

No Favorites file! There is no FAVORITE file.

Printing Error One of the following problems occurred during printing.

- Printer power off
- Out of paper
- Out of ink
- Printer internal error

Record Error Image compression could not be performed during image data storage for some reason. Record the image again.

SYSTEM ERROR Your camera system is corrupted. Contact your retailer or a CASIO service center.

| | |
|--|--|
| The card is locked. | The LOCK switch of the SD memory card is locked. You cannot store images to or delete images from a memory card that is locked. |
| There are no files. | There are no files in built-in memory or on the memory card. |
| There are no printing images. | There are no DPOF settings specifying images and the number of copies of each for printing. |
| Set up DPOF. | Configure the required DPOF settings (page 143). |
| There is no file to register. | You are trying to save an invalid file as a BESTSHOT user setup, or as an original startup image. |
| This card is not formatted. | The memory card is not formatted. Format the memory card (page 138). |
| This file cannot be played. | The image file or audio file is corrupted, or is a type that cannot be displayed by this camera. |
| This function cannot be used. | You attempted to copy files from built-in memory to a memory card while there is no memory card loaded in the camera (page 137). |
| This function is not supported for this file. | The function you are trying to perform is not supported for the file on which you are trying to perform it. |

Specifications

Main Specifications

Product Digital Camera

Model EX-Z30/EX-Z40

■ Camera Functions

Image Files Format

Snapshots JPEG (Exif Ver.2.2); DCF (Design rule for Camera File system) 1.0 standard; DPOF compliant

Movies AVI (Motion JPEG)

Audio WAV

Recording Media 9.7MB built-in Flash memory
SD Memory Card
MultimediaCard

Image Size

Snapshots • EX-Z30
2048 x 1536 pixels
2048 x 1360 (3:2) pixels
1600 x 1200 pixels
1280 x 960 pixels
640 x 480 pixels

APPENDIX

- EX-Z40
 - 2304 x 1728 pixels
 - 2304 x 1536 (3:2) pixels
 - 1600 x 1200 pixels
 - 1280 x 960 pixels
 - 640 x 480 pixels

Movies 320 x 240 pixels

Approximate Memory Capacity and File sizes:

- Snapshots

EX-Z30

| File Size (pixels) | Quality | Approximate Image File Size | Built-in flash memory 9.7MB | SD Memory Card* 64MB |
|--------------------|---------|-----------------------------|-----------------------------|----------------------|
| 2048 x 1536 | Fine | 1.6MB | 5 shots | 34 shots |
| | Normal | 1.2MB | 7 shots | 45 shots |
| | Economy | 630KB | 14 shots | 88 shots |
| 2048 x 1360 (3:2) | Fine | 1.5MB | 5 shots | 36 shots |
| | Normal | 1.1MB | 8 shots | 50 shots |
| | Economy | 580KB | 15 shots | 95 shots |
| 1600 x 1200 (UXGA) | Fine | 1050KB | 8 shots | 53 shots |
| | Normal | 710KB | 12 shots | 79 shots |
| | Economy | 370KB | 24 shots | 154 shots |
| 1280 x 960 (SXGA) | Fine | 680KB | 13 shots | 82 shots |
| | Normal | 460KB | 20 shots | 126 shots |
| | Economy | 250KB | 35 shots | 221 shots |
| 640 x 480 (VGA) | Fine | 190KB | 46 shots | 294 shots |
| | Normal | 140KB | 61 shots | 386 shots |
| | Economy | 90KB | 98 shots | 618 shots |

EX-Z40

| File Size (pixels) | Quality | Approximate Image File Size | Built-in flash memory 9.7MB | SD Memory Card* 64MB |
|--------------------|---------|-----------------------------|-----------------------------|----------------------|
| 2304 x 1728 | Fine | 1.9MB | 4 shots | 30 shots |
| | Normal | 1.5MB | 6 shots | 37 shots |
| | Economy | 1.1MB | 8 shots | 50 shots |
| 2304 x 1536 (3:2) | Fine | 1.8MB | 5 shots | 32 shots |
| | Normal | 1.4MB | 6 shots | 40 shots |
| | Economy | 1.0MB | 8 shots | 54 shots |
| 1600 x 1200 (UXGA) | Fine | 1050KB | 8 shots | 53 shots |
| | Normal | 710KB | 12 shots | 79 shots |
| | Economy | 370KB | 24 shots | 154 shots |
| 1280 x 960 (SXGA) | Fine | 680KB | 13 shots | 82 shots |
| | Normal | 460KB | 20 shots | 126 shots |
| | Economy | 250KB | 35 shots | 221 shots |
| 640 x 480 (VGA) | Fine | 190KB | 46 shots | 294 shots |
| | Normal | 140KB | 61 shots | 386 shots |
| | Economy | 90KB | 98 shots | 618 shots |

APPENDIX

- Movies (320 x 240 pixels)

| | |
|-----------|-------------------|
| Data Size | 300KB/second max. |
|-----------|-------------------|

| | |
|----------------------------------|--|
| Delete | Single-file, all files (with protection) |
| Effective Pixels | EX-Z30: 3.2 million EX-Z40: 4.0 million |
| Imaging Element | EX-Z30: 1/2.5-inch square pixel color CCD (Total pixels: 3.34 million) EX-Z40: 1/2.5-inch square pixel color CCD (Total pixels: 4.23 million) |
| Lens/Focal Distance | F2.6 (W) to 4.8 (T); f=5.8 (W) to 17.4mm (T) (equivalent to approximately 35 (W) to 105 (T) for 35mm film) |
| Zoom | 3X optical zoom; 4X digital zoom (12X in combination with optical zoom) |
| Focusing | Contrast-type Auto Focus (AF Mode (AF Area: Spot or Multi), Macro Mode), Pan Focus; Infinity Mode; focus lock; manual focus |

Approximate Focus Range (from lens surface)

| | |
|--------------|--|
| Normal | 40cm to ∞ (1.3' to ∞) |
| Macro | 6cm to 50cm (2.4" to 19.7") In the Macro mode, the optical zoom range is 1X to 1.8X. |

Exposure Control

| | |
|-----------------------------|----------------------------|
| Light Metering | Multi-pattern by CCD |
| Exposure | Program AE |
| Exposure Compensation | -2EV to +2EV (1/3EV units) |

| | |
|----------------------|--|
| Shutter | CCD electronic shutter; mechanical shutter, 1/8 to 1/2000 second • Shutter speed is different for the following BESTSHOT scenes. Night Scene: 4 to 1/2000 second Fireworks: 2 seconds (fixed) |
|----------------------|--|

| | |
|-----------------------|--------------------------|
| Aperture | F2.6/4.3, auto switching |
|-----------------------|--------------------------|

| | |
|----------------------------|---|
| White Balance | Automatic, fixed (5 modes), manual switching |
|----------------------------|---|

| | |
|-------------------------|--|
| Self-timer | 10 seconds, 2 seconds, Triple Self- timer |
|-------------------------|--|

Built-in Flash

| | |
|-------------------|---|
| Flash Modes | AUTO, ON, OFF, Red eye reduction |
| Flash Range | Wide Angle Optical Zoom: 0.5 to 3.4 meters (1.6' to 11.2') Telephoto Optical Zoom: 0.4 to 1.8 meters (1.3' to 5.9') (ISO Sensitivity: "Auto") |

| | |
|----------------------------------|---|
| Recording Functions | Snapshot with audio; Macro; self-timer; BESTSHOT; Movie with audio; voice recording * Audio recording is monaural. |
|----------------------------------|---|

APPENDIX

Audio Recording Time

| | |
|-----------------------|---|
| Audio Snapshot | Approximately 30 seconds maximum per image |
| Voice Recording | Approximately 40 minutes with built-in memory |
| After Recording | Approximately 30 seconds maximum per image |

Monitor Screen 2.0-inch TFT color LCD
84,960 pixels (354 x 240)

Viewfinder Monitor screen and optical viewfinder

Timekeeping Functions Built-in digital quartz clock

| | |
|---------------------|---|
| Date and Time | Recorded with image data |
| Auto Calendar | To 2049 |
| World Time | City; Date; Time; Summer time; 162 cities in 32 time zones |

Input/Output Terminals Cradle connector

Microphone Monaural

Speaker Monaural

■ Power Requirements

Power Requirements Rechargeable lithium ion battery
(NP-40) x 1

Approximate Battery Life:

The values below indicate the amount of time under the conditions defined below, until power automatically turns off due to battery failure. They do not guarantee that you will be able to achieve this level of operation. Low temperatures shorten battery life.

| Model | EX-Z30 | EX-Z40 |
|--|---------------------------|---------------------------|
| Operation | Apporoximate Battery Life | Apporoximate Battery Life |
| Number of Shots (CIPA)*1 (Operating Time) | 360 shots (180 minutes) | 360 shots (180 minutes) |
| Number of Shots, Continuous Recording*2 (Operating Time) | 1260 shots (210 minutes) | 1140 shots (190 minutes) |
| Continuous Playback*3 (Continuous Snapshot Recording) | 360 minutes | 360 minutes |
| Continuous Voice Recording*4 | 300 minutes | 300 minutes |

Supported Battery: NP-40 (Rated Capacitance: 1230mAh)
Storage Medium: SD Memory Card

*1 Number of Shots (CIPA)

- CIPA Standard
- Temperature: 23°C (73°F)
- Monitor Screen: On
- Zoom operation between full wide to full telephoto every 30 seconds, during which two images are recorded, one image with flash; power turned off and back on every time 10 images are recorded.

APPENDIX

*2 Continuous Recording Conditions

- Temperature: 23°C (73°F)
- Monitor screen: On
- Flash: Off
- Image recorded every 10 seconds, alternating full wide-angle and full telephoto zoom

*3 Continuous Playback Conditions

- Temperature: 23°C (73°F)
- Scroll one image about every 10 seconds

*4 Voice recording times are based on continuous recording.

Power Consumption DC 3.7V Approximately 2.6W

Dimensions 87(W) x 57(H) x 23.1(D) mm
(3.4"(W) x 2.2"(H) x 0.91"(D))
(excluding projections; 19.7mm (0.78")
at thinnest part)

Weight Approximately 121 g (4.3 oz)
(excluding battery and accessories)

Bundled Accessories Rechargeable lithium ion battery (NP-40); USB cradle (CA-24); Special AC adaptor; AC power cord; USB cable; Strap; CD-ROM; Basic Reference

■ Rechargeable Lithium Ion Battery (NP-40)

Rated Voltage 3.7 V

Rated Capacitance 1230 mAh

Operating Temperature

Range 0°C to 40°C (32°F to 104°F)

Dimensions 38.5(W) x 38.0(H) x 9.3(D) mm
(1.53"(W) x 1.50"(H) x 0.37"(D))

Weight Approximately 34 g (1.2 oz)

■ USB Cradle (CA-24)

Input/Output Terminals Camera connector; USB port; AC adaptor terminal (DC IN 5.3V)

Power Consumption DC 5.3V Approximately 3.2W

Dimensions 103(W) x 32(H) x 70(D) mm
(4.1"(W) x 1.3"(H) x 2.8"(D))
(excluding projections)

Weight Approximately 71 g (2.5 oz)

■ Special AC Adaptor (Inlet Type)

Power Requirement 100 to 240V AC, 50/60Hz, 83 mA

Output 5.3V DC, 650 mA

Dimensions 78(W) x 20(H) x 39(D) mm
(3.1"(W) x 0.8"(H) x 1.5"(D))
(excluding projections and cable)

Weight Approximately 90 g (3.2 oz)

■ Special AC Adaptor (Plug-in Type)

Power Requirement 100 to 240V AC, 50/60Hz, 83mA

Output 5.3V DC, 650mA

Dimensions 48(W) x 16(H) x 69(D) mm
(1.9"(W) x 0.6"(H) x 2.7"(D))
(excluding projections and cable)

Weight Approximately 95 g (3.6 oz)

Power Supply

- Use only the special NP-40 rechargeable lithium ion battery to power this camera. Use of any other type of battery is not supported.
- This camera does not have a separate battery for the clock. The date and time settings of the camera are cleared whenever power is totally cut off (from both the battery and USB cradle). Be sure to reconfigure these settings after power is interrupted (page 42).

LCD Panel

- The LCD panel is a product of the latest LCD manufacturing technology that provides a pixel yield of 99.99%. This means that less than 0.01% of the total pixels are defective (they do not turn on or always remain turned on).

Lens

- You may sometimes notice some distortion in certain types of images, such as a slight bend in lines that should be straight. This is due to the characteristics of lens, and does not indicate malfunction of the camera.