



LCD TV

LA40F7

LA46F7

Contact SAMSUNG WORLD-WIDE

If you have any questions or comments relating to Samsung products, please contact the SAMSUNG customer care centre.

Country	Customer Care Center ☎	Web Site
AUSTRALIA	1300 362 603	www.samsung.com/au
CHINA	800-810-5858, 010- 6475 1880	www.samsung.com.cn
HONG KONG	2862 6001	www.samsung.com/hk
INDIA	3030 8282, 1800 1100 11	www.samsung.com/in
INDONESIA	0800-112-8888	www.samsung.com/id
JAPAN	0120-327-527	www.samsung.com/jp
MALAYSIA	1800-88-9999	www.samsung.com/my
PHILIPPINES	1800-10-SAMSUNG (7267864)	www.samsung.com/ph
SINGAPORE	1800-SAMSUNG (7267864)	www.samsung.com/sg
SOUTH AFRICA	0860 7267864 (SAMSUNG)	www.samsung.com/za
TAIWAN	0800-329-999	www.samsung.com/tw
THAILAND	1800-29-3232, 02-689-3232	www.samsung.com/th
U.A.E	800SAMSUNG (7267864)	www.samsung.com/mea
VIETNAM	1 800 588 889	www.samsung.com/vn

Owner's Instructions

Before operating the unit, please read this manual thoroughly, and retain it for future reference.

**ON-SCREEN MENUS
PC DISPLAY
PICTURE IN PICTURE (PIP)
TELETEXT**

Register your product at www.samsung.com/global/register

Precautions When Displaying a Still Image

A still image may cause permanent damage to the TV screen.

- Do not display a still image on the LCD panel for more than 2 hours as it can cause screen image retention.

This image retention is also known as "screen burn".

- To avoid such image retention, reduce the degree of brightness and contrast of the screen when displaying a still image.



Watching the LCD TV in 4:3 format for a long period of time may leave traces of borders displayed on the left, right and center of the screen caused by the difference of light emission on the screen.

Playing a DVD or a game console may cause a similar effect to the screen.

Damages caused by the above effect are not covered by the Warranty.

- Displaying still images from Video games and PC for longer than a certain period of time may produce partial after-images.

To prevent this effect, reduce the 'brightness' and 'contrast' when displaying still images.

Contents

CONNECTING AND PREPARING YOUR TV

■ List of Parts.....	2
■ Installing the Wall Mount Kit.....	2
■ Viewing the Control Panel.....	3
■ Viewing the Connection Panel.....	4
■ Viewing the Remote Control.....	6
■ Installing Batteries in the Remote Control.....	6
■ Switching On and Off.....	7
■ Placing Your Television in Standby Mode.....	7
■ Plug & Play.....	7

SETTING THE CHANNELS

■ Storing Channels Automatically.....	8
■ Storing Channels Manually.....	8
■ Setting the Channel Manager.....	9
■ Activating the Child Lock.....	10
■ Sorting the Stored Channels.....	10
■ Assigning Channels Names.....	11
■ Fine Tuning Channel Reception.....	11

SETTING THE PICTURE

■ Changing the Picture Standard.....	12
■ Adjusting the Custom Picture.....	12
■ Changing the Colour Tone.....	13
■ Adjusting the Colour Tone with the Preferred Colour Component.....	13
■ Resetting the Picture Settings to the Factory Defaults.....	14
■ Changing the Picture Size.....	14
■ Freezing the Current Picture.....	14
■ Digital Noise Reduction.....	15
■ DNIe Demo (Digital Natural Image engine).....	15
■ Viewing the Picture In Picture (PIP).....	16

SETTING THE SOUND

■ Changing the Sound Standard.....	17
■ Adjusting the Sound Settings.....	17
■ Setting the TruSurround XT (SRS TSXT).....	17
■ Adjusting the Volume Automatically.....	18
■ Selecting the Internal Mute.....	18
■ Listening to the Sound of the Sub Picture.....	18
■ Resetting the Sound Settings to the Factory Defaults.....	19
■ Connecting Headphones.....	19
■ Selecting the Sound Mode.....	19

SETTING THE TIME

■ Setting and Displaying the Current Time.....	19
■ Setting the Sleep Timer.....	20
■ Switching the Television On and Off Automatically.....	20

SETTING THE OTHERS

■ Choosing Your Language.....	21
■ Using Game Mode.....	21
■ Setting the Blue Screen Mode / Selecting the Melody.....	22
■ Using the Energy Saving Feature.....	22
■ Setting the Blue Eye.....	22
■ Selecting the Source.....	23
■ Editing the Input Source Names.....	23

WISELINK

■ Using the WISELINK Function.....	24
■ Using the WISELINK Menu.....	25
■ Using the PHOTO (JPEG) List.....	25
■ Viewing Photo File Information.....	27
■ Selecting a Photo and Slide Show.....	27
■ Rotating.....	28
■ Zooming-in.....	29
■ Copying Image Files.....	30
■ Deleting Image Files.....	30
■ Printing a Photo.....	31
■ Using the MP3 List.....	31
■ Copying Music Files.....	32
■ Deleting Music Files.....	32
■ Using the Setup Menu.....	33

USING THE TELETEXT FEATURE





■ Teletext Decoder.....	34
■ Displaying the Teletext Information.....	34
■ Selecting a Specific Teletext Page.....	35
■ Using Fastext to Select a Teletext Page.....	35
■ Setting Up Your Remote Control.....	36
■ Remote Control Codes.....	38

SETTING THE PC

■ Setting up Your PC Software (Based on Windows XP).....	41
■ Display Modes.....	41
■ Setting the PC.....	42

RECOMMENDATIONS FOR USE

■ Using the Anti-Theft Kensington Lock.....	43
■ Troubleshooting: Before Contacting Service Personnel.....	43
■ Technical and Environmental Specifications.....	44

			
Symbol	Press	Important	Note
			One-Touch Button

List of Parts

Please make sure the following items are included with your LCD TV.
If any items are missing, contact your dealer.



Remote Control & Batteries
(AAA x 2)



Power Cord



Cover-Bottom



Cleaning Cloth

♦ Owner's Instructions

♦ Warranty card

♦ Safety Guide

♦ Registration Cards

➤ Warranty card / Safety Guide / Registration Cards (Not available in all locations)

Installing the Wall Mount Kit

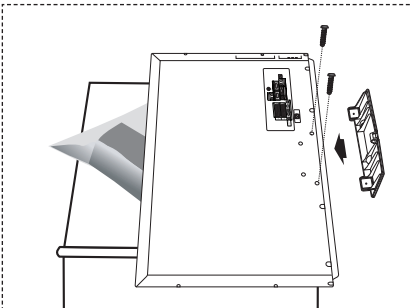

Wall mount items (sold separately) allow you to mount the TV on the wall.

For detailed information on installing the wall mount, see the instructions provided with the Wall Mount items. Contact a technician for assistance when installing the wall mounted bracket.

Samsung Electronics is not responsible for any damage to the product or injury to yourself or others if you elect to install the TV on your own.

➤ Remove the stand and cover the bottom hole with a cap and fasten with two screws.

Viewing the Control Panel

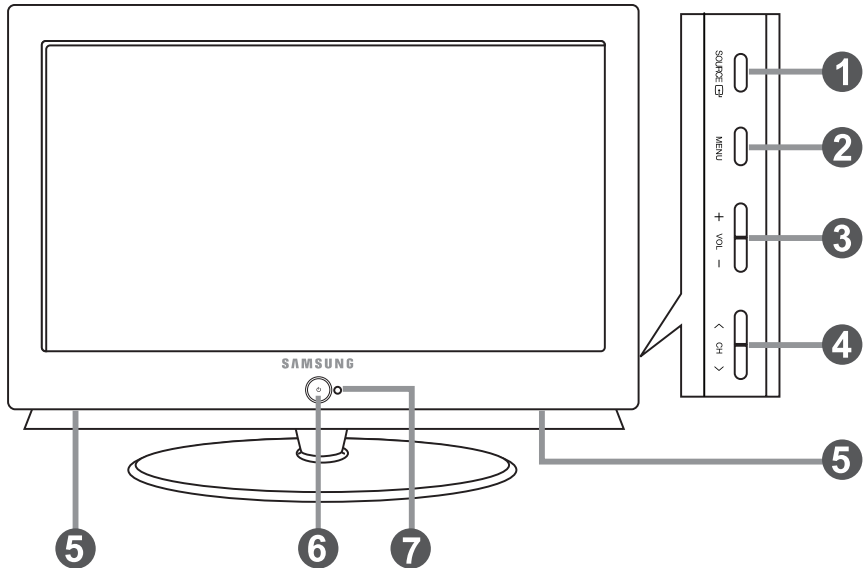

➤ The product colour and shape may vary depending on the model.

1 SOURCE

Toggles between all the available input sources (TV, AV1, AV2, S-Video, Component1, Component2, PC, HDMI1, HDMI2). In the on-screen menu, use this button as you use the **ENTER** button on the remote control.

2 MENU

Press to see an on-screen menu of your TV's features.

3 + VOL -

Press to decrease or increase the volume. In the on-screen menu, use the **+ VOL -** buttons as you use the **◀** and **▶** buttons on the remote control.

4 < CH >

Press to change channels. In the on-screen menu, use the **< CH >** buttons as you use the **▼** and **▲** buttons on the remote control. (Without the Remote Control, you can turn on the TV by using the Channel buttons.)

5 Speakers

6 (Power)

Press to turn the TV on and off.

Power Indicator

Blinks and turns off when the power is on and lights up in stand-by mode.

7 Remote Control Sensor

Aim the remote control towards this spot on the TV.

Viewing the Connection Panel

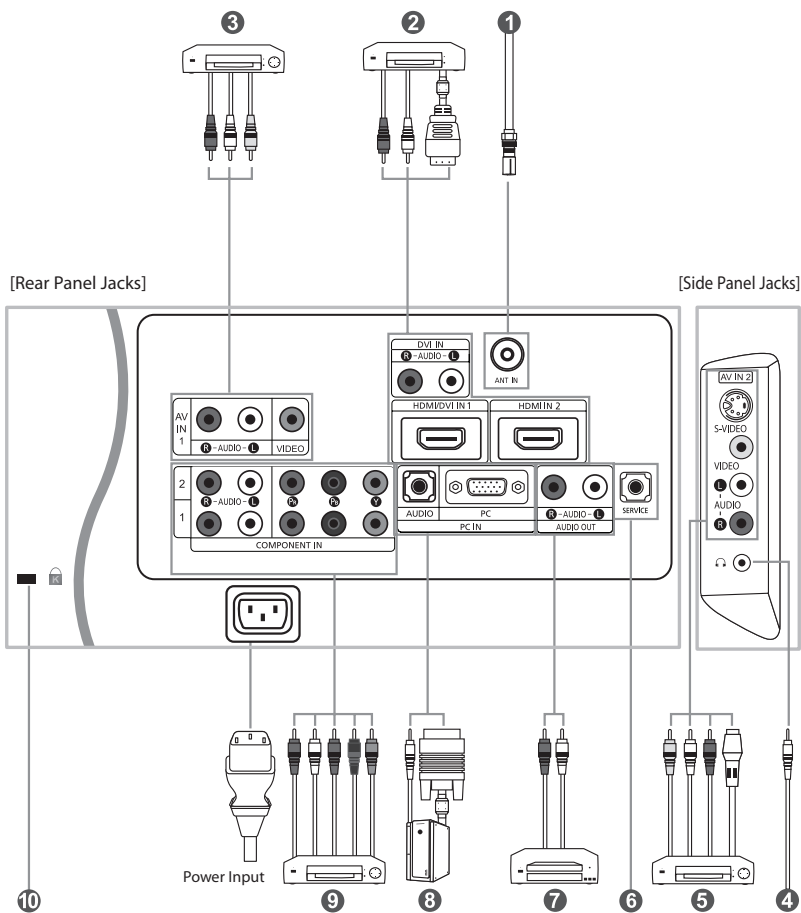

- ⚡ Whenever you connect an external device to your TV, make sure that power on the unit is turned off.
- ⚡ When connecting an external device, match the colour of the connection terminal to the cable.

1 Connecting an Aerial or Cable Television Network

To view television channels correctly, a signal must be received by the set from one of the following sources:

- An outdoor aerial / A cable television network / A satellite network

2 Connecting HDMI/DVI (HDMI/DVI IN 1, HDMI IN 2)

- Supports connections between HDMI-connection-enabled AV devices (Set-Top Boxes, DVD players, AV receivers and digital TVs).
- No additional Audio connection is needed for an HDMI to HDMI connection.

➤ What is HDMI?

- "High Definition Multimedia Interface" allows the transmission of high definition digital video data and multiple channels of digital audio (5.1 channels).
- The HDMI/DVI terminal supports DVI connection to an extended device with the appropriate cable (not supplied). The difference between HDMI and DVI is that the HDMI device is smaller in size, has the HDCP (High Bandwidth Digital Copy Protection) coding feature installed, and supports multi-channel digital audio.

➤ You should use the DVI-to-HDMI cable or DVI-HDMI Adapter for the connection, and the "R - AUDIO - L" terminal on DVI for sound output.

- When connecting this product via HDMI or DVI to a Set Top Box, DVD Player or Games Console etc, make sure that it has been set to a compatible video output mode as shown in the table below.

Failure to observe this may result in picture distortion, image breakup or no picture.

➤ Supported modes for HDMI/DVI and COMPONENT

	480i	480p	576i	576p	720p	1080i	1080p
50 Hz	X	X	X	O	O	O	O
60 Hz	X	O	X	X	O	O	O
Component	O	O	O	O	O	O	O

- Do not attempt to connect the HDMI/DVI connector to a PC or Laptop Graphics Card. (This will result in a blank screen being displayed)

3 Connecting External A/V Devices (AV IN 1)

- Connect RCA cable to an appropriate external A/V device such as VCR, DVD or Camcorder.
- Connect RCA audio cables to "R - AUDIO - L" on the rear of your set and the other ends to corresponding audio out connectors on the A/V device.

5 Connecting External A/V Devices

- Connect RCA or S-VIDEO cable to an appropriate external A/V device such as VCR, DVD or Camcorder.
- Connect RCA audio cables to "R - AUDIO - L" on the rear of your set and the other ends to corresponding audio out connectors on the A/V device.
- Headphone may be connected to the headphone output (4) on the rear of your set. While the headphone is connected, the sound from the built-in speakers will be disabled.

6 SERVICE

- Service connection for qualified service engineer.

7 Connecting AUDIO

- Connect RCA audio cables to "R - AUDIO - L" on the rear of your set and the other ends to corresponding audio in connectors on the Amplifier or DVD Home Theater.

8 Connecting Computer

- Connect the D-Sub cable (optional) to "PC (PC IN)" on the rear of your set and the other end to the Video Card of your computer.
- Connect the stereo audio cable (optional) to "AUDIO (PC IN)" on the rear of your set and the other end to "Audio Out" of the sound card on your computer.

9 Connecting Component Devices (DTV/DVD)

- Connect component video cables (optional) to component connector ("P_s", "P_b", "Y") on the rear of your set and the other ends to corresponding component video out connectors on the DTV or DVD.
- If you wish to connect both the Set-Top Box and DTV (or DVD), you should connect the Set-Top Box to the DTV (or DVD) and connect the DTV (or DVD) to component connector ("P_s", "P_b", "Y") on your set.
- The P_s, P_b and Y connectors on your component devices (DTV or DVD) are sometimes labeled Y, B-Y and R-Y or Y, Cb and Cr.
- Connect RCA audio cables (optional) to "R - AUDIO - L" on the rear of your set and the other ends to corresponding audio out connectors on the DTV or DVD.
- This LCD TV displays its optimum picture resolution in 1080p mode.
- This LCD TV displays its maximum picture resolution in 1080p mode.

11 Kensington Lock

- The Kensington lock (optional) is a device used to physically fix the system when used in a public place.
- If you want to use a locking device, contact the dealer where you purchased the TV.
- The place of the Kensington Lock may be different depending on its model.

Viewing the Remote Control

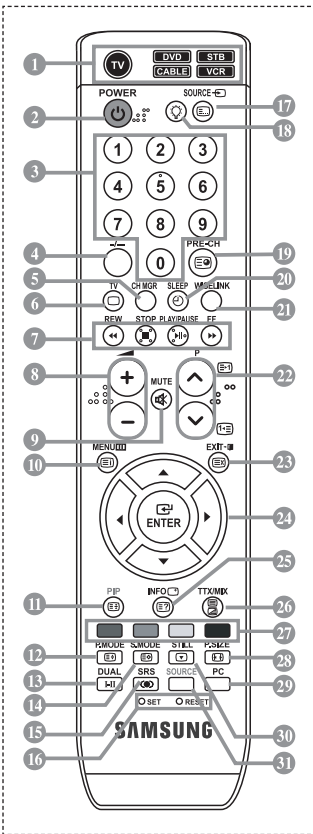

- 1 Selects a target device to be controlled by the Samsung remote control (TV, DVD, STB, CABLE, VCR) (Refer to page 36~40)
- 2 Television Standby button
- 3 Number buttons for direct channel access
- 4 One/Two-digit channel selection
- 5 It displays "Channel Manager" on the screen.
- 6 Selects the TV mode directly
- 7 VCR/DVD Functions Rewind, Stop, Play/Pause, Fast/Forward
- 8 Volume increase
 Volume decrease
- 9 Temporary sound switch-off
- 10 Menu display and change confirmation
- 11 Picture-In-Picture On / Off
- 12 Picture effect selection
- 13 Sound effect selection
- 14 Sound mode selection
- 15 SRS TSXT selection
- 16 **SET:** Adjusts 5 separate devices - TV, DVD, STB, CABLE, or VCR.
RESET: When your remote does not work, change the batteries and press the "RESET" button for 2-3 seconds before use.
- 17 Available source selection
- 18 When pressing this button, a number of buttons on the remote control (e.g. Selects a target device, volume, channel and MUTE buttons) light up for a few seconds and then turn off to save power. This function is to conveniently use the remote control at night or when dark.
- 19 Previous channel
- 20 Automatic Power-off
- 21 This function enables you to load saved photo (JPEG) and audio files (MP3) and to view or play them on the TV.
- 22 Next channel
 Previous channel
- 23 Exit the OSD
- 24 Control the cursor in the menu
- 25 Use to see information on the current broadcast
- 26 Picture size selection
- 27 Selects the PC mode directly
- 28 Input source selection

- 29 **Teletext Functions**
- 30 Exit from the Teletext display
- 31 Teletext index
- 32 Teletext hold
- 33 Teletext size selection
- 34 Teletext store
- 35 Teletext mode selection (LIST/FLOF)
- 36 Teletext sub page
- 37 Teletext next page
 Teletext previous page
- 38 Teletext cancel
- 39 Teletext reveal
- 40 Alternately select Teletext, Double, or Mix.
- 41 Fastest topic selection

- The performance of the remote control may be affected by bright light.
- This is a special remote control for the visually impaired, and has Braille points on the Power, Channel and Volume buttons.

Installing Batteries in the Remote Control

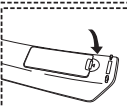
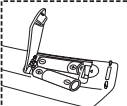
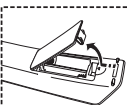

1. Lift the cover at the back of the remote control upward as shown in the figure.
2. Install two AAA size batteries.
 - Make sure to match the "+" and "-" ends of the batteries with the diagram inside the compartment.
3. Replace the cover.
 - Remove the batteries and store them in a cool, dry place if you won't be using the remote control for a long time. The remote control can be used up to about 23 feet from the TV.
(Assuming typical TV usage, the batteries last for about one year.)

➤ If the remote control doesn't work, check the following:

1. Is the TV power on?
2. Are the plus and minus ends of the batteries reversed?
3. Are the batteries drained?
4. Is there a power outage, or is the power cord unplugged?
5. Is there a special fluorescent light or neon sign nearby?

Switching On and Off

The mains lead is attached to the rear of your set.

1. Plug the mains lead into an appropriate socket.
 - The standby indicator lights up on the front of the set.
2. Press the **⏻** button on the front of the set.
 - You also can press the **POWER** **⏻** button or the **TV** (Ⓜ) button on the remote control to turn the TV on.
 - The programme that you were watching last is reselected automatically.
3. Press the numeric button (0~9) or channel up/down (Ⓜ/Ⓜ) button on the remote control or **< CH >** button on the right side of the set.
 - When you switch the set on for the very first time, you will be asked to choose language in which the menus are to be displayed.
4. To switch your set off, press the **POWER** **⏻** button again.

Placing Your Television in Standby Mode

Your set can be placed in standby mode in order to reduce the power consumption. The standby mode can be useful when you wish to interrupt viewing temporarily (during a meal, for example).

1. Press the **POWER** **⏻** button on the remote control.
 - The screen is turned off and a blue standby indicator appears on the front of your set.
2. To switch your set back on, simply press the **POWER** **⏻**, numeric buttons (0~9) or channel up/down (Ⓜ/Ⓜ) button again.
 - Do not leave your set in standby mode for long periods of time (when you are away on holiday, for example). It is best to unplug the set from the mains and aerial.

Plug & Play



When the TV is initially powered on, several basic settings proceed automatically and subsequently. The following settings are available.

1. Press the **POWER** **⏻** button on the remote control.
The message "Start Plug & Play" is displayed with "OK" selected.
2. Press the **◀** or **▶** buttons to select "Shop" or "Home", then the **ENTER** button.
 - We recommend setting the TV to Home mode for the best picture in your home environment.
 - Shop mode is only intended for use in retail environments.
 - If the unit is accidentally set to Shop Mode, press and hold the **MENU** button on the side panel of the TV for five seconds to return to Dynamic (Home) mode.
3. Select the appropriate language by pressing the **▲** or **▼** button.
Press the **ENTER** button to confirm your choice.
4. The message "Check antenna input" is displayed with "OK" selected.
Press the **ENTER** button.
 - Please check that the antenna cable is connected correctly.
5. Select the appropriate area by pressing the **▲** or **▼** button.
Press the **ENTER** button to confirm your choice.
6. The "Auto Store" menu is displayed with the "Start" selected.
Press the **ENTER** button.
 - The channel search will start and end automatically.
 - After all the available channels are stored, the "Clock Set" menu appears.
 - Press the **ENTER** button at any time to interrupt the memorization process.
7. Press the **ENTER** button.
Set the "Hour" or "Minute", "am/pm" by pressing the **◀** or **▶** button.
Set the "Hour" or "Minute", "am/pm" by pressing the **▲** or **▼** button.
 - You can also set the hour and minute by pressing the number buttons on the remote control.
8. Press the **ENTER** button to confirm your setting.

- **Language:** Select your language.
- **Area:** Select your country.
- **Auto Store:** Automatically scans for and stores channels available in the local area.
- **Clock Set:** Sets the current time for the TV clock.



If you want to reset this feature...

1. Press the **MENU** button to display the menu.
Press the **▲** or **▼** button to select "Setup", then press the **ENTER** button.
2. Press the **ENTER** button again, to select "Plug & Play".
3. The message to "Start Plug & Play" is displayed.



- Storing Channels Automatically

- Storing Channels Manually

Storing Channels Automatically

You can scan for the frequency ranges available to you (and availability depends on your country). Automatically allocated programme numbers may not correspond to actual or desired programme numbers. However, you can sort numbers manually and clear any channels you do not wish to watch.

1. Press the **MENU** button to display the menu.
Press the **▲** or **▼** button to select "Channel", then press the **ENTER** button.
2. Press the **ENTER** button to select "Area".
3. Select the appropriate country by pressing the **▲** or **▼** button.
Press the **ENTER** button to confirm your choice.
4. Press the **▲** or **▼** button to select "Auto Store", then press the **ENTER** button.
5. Press the **ENTER** button.
 - The TV will begin memorizing all of the available channels.
 - Press the **ENTER** button at any time to interrupt the memorization process and return to the "Channel" menu.
6. After all the available channels are stored, the "Sort" menu appears.

Storing Channels Manually

You can store up to 100 channels, including those received via cable networks.

When storing channels manually, you can choose:

- ◆ ***Whether or not to store each of the channels found.***
- ◆ ***The programme number of each stored channel which you wish to identify.***

1. Press the **MENU** button to display the menu.
Press the **▲** or **▼** button to select "Channel", then press the **ENTER** button.
2. Press the **▲** or **▼** button to select "Manual Store", then press the **ENTER** button.
3. Press the **ENTER** button to select "Programme".
4. To assign a programme number to a channel, find the correct number by pressing the **▲** or **▼** button and then press the **ENTER** button.
 - You can also set a programme number by pressing the number buttons on the remote control.

5. Press the **▲** or **▼** button to select "Colour System", then press the **ENTER** button.
6. Select the colour standard required by pressing the **▲** or **▼** button then, press the **ENTER** button.
7. Press the **▲** or **▼** button to select "Sound System", then press the **ENTER** button.
8. Select the sound standard required by pressing the **▲** or **▼** button, then press the **ENTER** button.
 - If there is an abnormal sound or no sound, re-select the sound system required.
9. If you know the number of the channel to be stored, press the **▲** or **▼** button to select "Channel". Press the **ENTER** button. Select **C** (Air channel) or **S** (Cable channel) by pressing the **▲** or **▼** button. Press the **▶** button to select channel. Select the required number by pressing the **▲** or **▼** button and then press the **ENTER** button.
 - Channel mode: **P** (Programme mode), **C** (Air channel mode), **S** (Cable channel mode)
 - You can also set a channel number by pressing number buttons on the remote control.
10. If you do not know the channel numbers, press the **▲** or **▼** button to select "Search". Press the **ENTER** button. Search by pressing the **▲** or **▼** button and then press the **ENTER** button.
11. Press the **▲** or **▼** button to select "Store". Press the **ENTER** button to select "OK".
12. Repeat steps **3** to **11** for each channel to be stored.

- **Programme:** Selects a program number for the channel.
- **Colour System:** Sets the colour supporting system.
- **Sound System:** Sets the sound supporting system.

- **Channel:** Selects a channel.
- **Search:** Scans for the frequency value for the channel.
- **Store:** Saves your settings.

Setting the Channel Manager

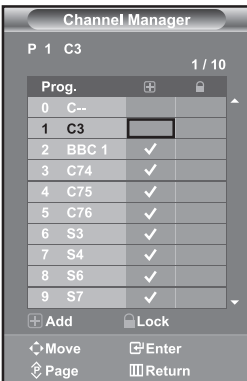

Set the channels according to your preference.

You can easily delete, add, or lock the channel you want.

1. Press the **MENU** button to display the menu. Press the **▲** or **▼** button to select "Channel", then press the **ENTER** button.
2. Press the **▲** or **▼** button to select "Channel Manager", then press the **ENTER** button.
3. Press the **ENTER** button again, to select "Channel Manager".
4. Press the **▶** button to select "⊕" line.
5. Press the **▲** or **▼** button to select the undesired channel, then press the **ENTER** button to cancel.
6. Repeat steps **5** for each channel to be selected or canceled
7. Press the **EXIT** button to exit.

➤ "⊕" is active when "Child Lock" is selected to "On".

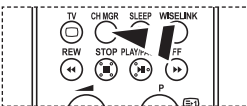

You can select these options by simply pressing the **CH MGR** button on the remote control.

Activating the Child Lock



This feature allows you to prevent unauthorized users, such as children, from watching unsuitable programmes by muting out video and audio. Child Lock cannot be released using the buttons on the side.

Only the remote control can release the Child Lock setting, so keep the remote control away from children.

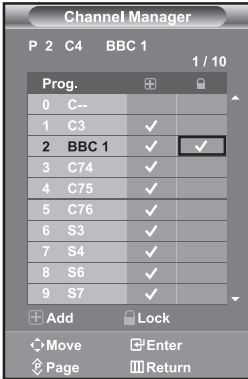

1. Press the **MENU** button to display the menu. Press the **▲** or **▼** button to select "Channel", then press the **ENTER** button.
 2. Press the **▲** or **▼** button to select "Channel Manager", then press the **ENTER** button.
 3. Press the **▲** or **▼** button to select "Child Lock", then press the **ENTER** button.
 4. Press the **▲** or **▼** button to select "On". Press the **ENTER** button.
 5. Press the **▲** or **▼** button to select "Channel Manager", then press the **ENTER** button.
 6. Press the **▶** button to select "🔒" line.
 7. Press the **▲** or **▼** button to select the channels you want to lock, then press the **ENTER** button.
 8. Repeat steps 7 for each channel to be locked or unlocked.
 9. Press the **EXIT** button to exit.
- Select "On" or "Off" in "Child Lock" to easily turn the channels which selected on "🔒" to be active or inactive.

Sorting the Stored Channels

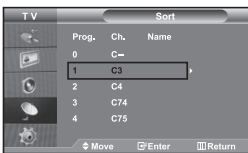

You can exchange the numbers of two channels, in order to:

- ◆ *Modify the numeric order in which the channels have been automatically stored.*
- ◆ *Give easily remembered numbers to the channels that you watch most often.*

1. Press the **MENU** button to display the menu. Press the **▲** or **▼** button to select "Channel", then press the **ENTER** button.
2. Press the **▲** or **▼** button to select "Sort", then press the **ENTER** button.
3. Select channel number that you wish to change by pressing the **▲** or **▼** button repeatedly. Press the **ENTER** button.
 - The selected channel number and name are moved to right side.
4. Press the **▲** or **▼** button to move to the position in which you would like to change and then press the **ENTER** button.
 - The selected channel is exchanged with the one previously stored to the chosen number.
5. Repeat steps 3 to 4 for another channel to be sorted.
6. Press the **EXIT** button to exit.

Assigning Channels Names

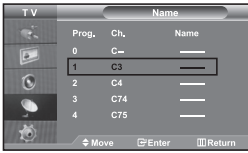

Channel names will be assigned automatically when channel information is broadcast.

These names can be changed, allowing you to assign new names.

1. Press the **MENU** button to display the menu. Press the **▲** or **▼** button to select "Channel", then press the **ENTER** button.
2. Press the **▲** or **▼** button to select "Name", then press the **ENTER** button.
3. If necessary, select the channel to be assigned to a new name by pressing the **▲** or **▼** button. Press the **ENTER** button.
 - The selection bar is displayed around the name box.
4.

To...	Then...
Select a letter, number or symbol	Press the ▲ or ▼ button
Move on the next letter	Press the ▶ button
Move back the previous letter	Press the ◀ button
Confirm the name	Press the ENTER button

 - The characters available are :
Letters of the alphabet (A~Z) / Numbers (0~9) / Special characters (, space)
5. Repeat steps 3 to 4 for each channel to be assigned to a new name.
6. Press the **EXIT** button to exit.

Fine Tuning Channel Reception

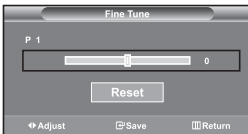

Use fine tuning to manually adjust a particular channel for optimal reception.

1. Use the number buttons to directly select the channel that you want to fine tune.
2. Press the **MENU** button to display the menu. Press the **▲** or **▼** button to select "Channel", then press the **ENTER** button.
3. Press the **▲** or **▼** button to select "Fine Tune", then press the **ENTER** button.
4. Press the **◀** or **▶** button to adjust the fine tuning. Press the **ENTER** button.
5. Press the **EXIT** button to exit.
 - Fine tuned channels that have been saved are marked with an asterisk "*" on the right-hand side of the channel number in the channel banner. And the channel number turns red.
 - To reset the fine-tuning, select "Reset" by pressing the **▲** or **▼** button and then press the **ENTER** button.

Changing the Picture Standard

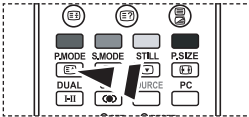
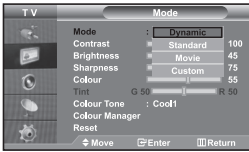

You can also press the **P.MODE** button on the remote control to select one of the picture settings.

You can select the type of picture which best corresponds to your viewing requirements.

1. Press the **MENU** button to display the menu. Press the **▲** or **▼** button to select "Picture", then press the **ENTER** button.
2. Press the **ENTER** button again, to select "Mode". Press the **ENTER** button again.
3. Press the **▲** or **▼** button to select the desired picture effect. Press the **ENTER** button.
4. Press the **EXIT** button to exit.

- **Dynamic:** Selects the picture for high-definition in a bright room.
- **Standard:** Selects the picture for optimum display in a normal environment.
- **Movie:** Selects the picture for comfortable display in a dark room.
- **Custom:** Select to view your favorite display settings.
(Refer to "Adjusting the Custom Picture")

- The Picture mode must be adjusted separately for each input source.
- You can return to the factory defaults picture settings by selecting the "Reset". (Refer to "Resetting the Picture Settings to the Factory Defaults" on page 14)

Adjusting the Custom Picture

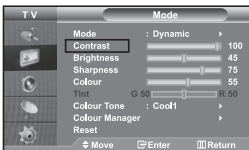

Your set has several settings which allow you to control picture quality.

1. To select the desired picture effect, follow the "Changing the Picture Standard" instructions number 1 to 3.
2. Press the **▲** or **▼** button to select a particular item. Press the **ENTER** button.
3. Press the **◀** or **▶** button to decrease or increase the value of a particular item. Press the **ENTER** button.
4. Press the **EXIT** button to exit.

- **Contrast:** Adjusts the lightness and darkness between objects and the background.
- **Brightness:** Adjusts the brightness of the whole screen.
- **Sharpness:** Adjusts the outline of objects to either sharpen them or make them more dull.
- **Colour:** Adjusts the colours, making them lighter or darker.
- **Tint (NTSC only):** Adjusts the colour of objects, making them more red or green for a more natural look.

- The adjusted values are stored according to the selected Picture mode.
- In PC Mode, Only "Contrast", "Brightness" and "Colour" can be adjusted

Changing the Colour Tone



You can select the most comfortable colour tone to your eyes.

1. To select the desired picture effect, follow the "Changing the Picture Standard" instructions number 1 to 3 on page 12.
2. Press the **▲** or **▼** button to select "Colour Tone", then press the **ENTER** button.
3. Press the **▲** or **▼** button to select the desired colour tone setting. Press the **ENTER** button.
4. Press the **EXIT** button to exit.

- | | |
|---|---|
| <ul style="list-style-type: none"> • Cool2: Makes the colour temperature bluer than "Cool1" menu. • Cool1: Makes whites bluish. • Normal: Keeps whites white. | <ul style="list-style-type: none"> • Warm1: Makes whites reddish. • Warm2: Makes the colour temperature redder than "Warm1" menu. |
|---|---|

➤ The adjusted values are stored according to the selected Picture mode.

Adjusting the Colour Tone with the Preferred Colour Component

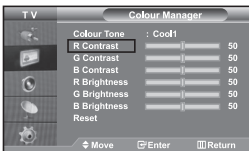

You can adjust a picture's Colour tone with your preferred Colour component.

1. To select the desired picture effect, follow the "Changing the Picture Standard" instructions number 1 to 3 on page 12.
2. Press the **▲** or **▼** button to select "Colour Manager", then press the **ENTER** button.
3. Press the **▲** or **▼** button to select a particular item. Press the **ENTER** button.
4. Press the **◀** or **▶** button to decrease or increase the value of a particular item. Press the **ENTER** button.
5. Press the **EXIT** button to exit.

- | | |
|------------------------|---|
| • R Contrast: | Lightens or intensifies the red component of the border between objects and the background. |
| • G Contrast: | Lightens or intensifies the green component of the border between objects and the background. |
| • B Contrast: | Lightens or intensifies the blue component of the border between objects and the background. |
| • R Brightness: | Adjusts the brightness of the red component for the entire screen. |
| • G Brightness: | Adjusts the brightness of the green component for the entire screen. |
| • B Brightness: | Adjusts the brightness of the blue component for the entire screen. |
| • Reset: | Resets all settings to the defaults. |

➤ You cannot select a "Colour Tone" in the "Colour Manager".

Resetting the Picture Settings to the Factory Defaults

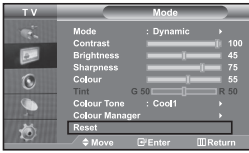

You can return to the factory defaults picture settings.

- To select the desired picture effect, follow the "Changing the Picture Standard" instructions number 1 to 3 on page 12.
- Press the **▲** or **▼** button to select "Reset", then press the **ENTER** button.
- Press the **EXIT** button to exit.
 - The "Reset" will be set for each picture mode.

Changing the Picture Size



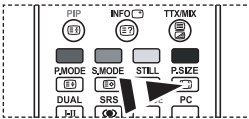

You can select the picture size which best corresponds to your viewing requirements.

- Press the **MENU** button to display the menu. Press the **▲** or **▼** button to select "Picture", then press the **ENTER** button.
- Press the **▲** or **▼** button to select "Size", then press the **ENTER** button.
- Select the required option by pressing the **▲** or **▼** button. Press the **ENTER** button.
- Press the **EXIT** button to exit.



You can select these options by simply pressing the **P.SIZE** button on the remote control.

- 16:9:** Adjusts the picture size to 16:9 appropriate for DVDs or wide broadcasting.
- WIDE 4:3:** Magnify the size of the picture more than 4:3.
- Zoom:** Magnifies the 16:9 wide picture (in the vertical direction) to fit the screen size.
- 4:3:** This is the default setting for a video movie or normal broadcasting.

- In PC Mode, only "16:9" and "4:3" mode can be adjusted.
- Zoom: Select  by pressing the **◀** or **▶** buttons. Use the **▲** or **▼** button to move the picture up and down. After selecting , use the **▲** or **▼** button to magnify or reduce the picture size in the vertical direction.
- WIDE 4:3: Move the screen up/down using the **▲** or **▼** button after selecting the  by pressing the **▶** or **ENTER** button.

Freezing the Current Picture

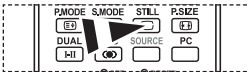

Press the **STILL** button to freeze a moving picture into a still one. Press again to cancel.

Digital Noise Reduction

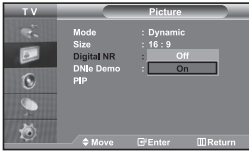

If the broadcast signal received by your TV is weak, you can activate the Digital Noise Reduction feature to help reduce any static and ghosting that may appear on the screen.

1. Press the **MENU** button to display the menu. Press the **▲** or **▼** button to select "Picture", then press the **ENTER** button.
2. Press the **▲** or **▼** button to select "Digital NR", then press the **ENTER** button.
3. Press the **▲** or **▼** button to select "On" or "Off". Press the **ENTER** button.
4. Press the **EXIT** button to exit.

DNle Demo (Digital Natural Image engine)

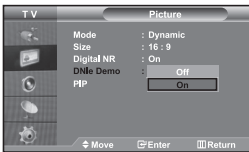

Samsung's new technology brings you more detailed images with contrast and white enhancement. A new image compensation algorithm gives viewers brighter and clearer images. DNle technology will match every signal to your eyes. You can see how DNle improves the picture by setting DNle Demo mode to On.

1. Press the **MENU** button to display the menu. Press the **▲** or **▼** button to select "Picture", then press the **ENTER** button.
 2. Press the **▲** or **▼** button to select "DNle Demo", then press the **ENTER** button.
 3. Press the **▲** or **▼** button to select "On" or "Off". Press the **ENTER** button.
 4. Press the **EXIT** button to exit.
- These functions don't work in PC mode.
 - The DNle Demo is designed to show the difference between the regular and DNle pictures.
 - By default, the product displays the picture with DNle applied.

Viewing the Picture In Picture (PIP)

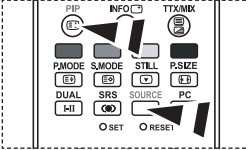
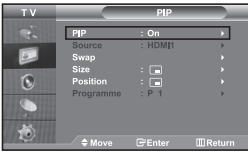

Press the **PIP** button on the remote control repeatedly to activate or deactivate the "PIP".

You can display a sub picture within the main picture of set programme or video input. In this way, you can watch the picture of set programme or video input from any connected equipment while watching the main picture.

1. Press the **MENU** button to display the menu. Press the **▲** or **▼** button to select "Picture", then press the **ENTER** button.
2. Press the **▲** or **▼** button to select "PIP", then press the **ENTER** button.
3. Press the **ENTER** button again.
Press the **▲** or **▼** button to select "On", then press **ENTER** button.
 - If the PIP is activated, the size of the main picture turns to "16:9".
4. Press the **▲** or **▼** button to select "Source", then press **ENTER** button. Select a source of the sub picture by pressing the **▲** or **▼** button and press the **ENTER** button.
 - The sub picture can serve different source selections based on what the main picture is set to.
5. Press the **▲** or **▼** button to select "Swap".
To interchange the main picture and the sub picture, select "Swap" option and press the **ENTER** button.
 - The main picture and the sub picture are interchanged.
 - If main picture is in "PC" mode, "Swap" is not available.
6. Press the **▲** or **▼** button to select "Size" of the sub picture and then press the **ENTER** button. Select a size of the sub picture by pressing the **▲** or **▼** button and then press the **ENTER** button.
 - If main picture is in "PC" mode, "Size" is not available.
7. Press the **▲** or **▼** button to select "Position", then press the **ENTER** button. Select the position of the sub picture by pressing the **▲** or **▼** button and then press the **ENTER** button.
8. Press the **▲** or **▼** button to select "Programme" and then press the **ENTER** button. You can select the channel that you want to view through sub picture by pressing the **▲** or **▼** button.
Press the **ENTER** button.
 - The "Programme" can be active when the sub picture is set to TV.
9. Press the **EXIT** button to exit.
 - You may notice that the picture in the PIP window becomes slightly unnatural when you use the main screen to view a game or karaoke.

• **Source:** Used to select a source of the sub picture.

• **Swap:** Used to interchange the main picture and the sub picture.

• **Size:** Used to select a size of the sub picture.

• **Position:** Used to move the sub picture.

• **Programme:** Used to Change the sub picture.

➤ **PIP Settings** (O: PIP operates, X: PIP doesn't operate)

Main \ Sub	TV	AV1	AV2	S-Video	Component1	Component2	PC	HDMI1	HDMI2
TV	X	X	X	X	X	X	X	O	O
AV1	X	X	X	X	X	X	X	O	O
AV2	X	X	X	X	X	X	X	O	O
S-Video	X	X	X	X	X	X	X	O	O
Component1	X	X	X	X	X	X	X	O	O
Component2	X	X	X	X	X	X	X	O	O
PC	O	O	O	X	X	X	X	X	X
HDMI1	O	O	O	O	O	O	X	X	X
HDMI2	O	O	O	O	O	O	X	X	X

Changing the Sound Standard

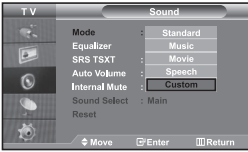

You can select the type of the special sound effect to be used when watching a given broadcast.

1. Press the **MENU** button to display the menu. Press the **▲** or **▼** button to select "Sound", then press the **ENTER** button.
2. Press the **ENTER** button again, to select "Mode".
3. Select the required sound effect by pressing the **▲** or **▼** button repeatedly and then press the **ENTER** button.
4. Press the **EXIT** button to exit.

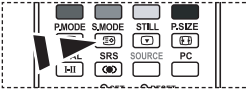

You can also select these options by simply pressing the **S.MODE** button on the remote control.

• **Standard:** Selects the normal sound mode.

• **Music:** Emphasizes music over voices.

• **Movie:** Provides live and full sound for movies.

• **Speech:** Emphasizes voices over other sounds.

• **Custom:** Selects your custom sound settings.
(Refer to "Adjusting the Sound Settings")

Adjusting the Sound Settings

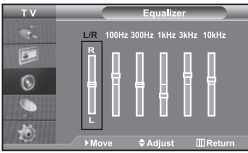

The sound settings can be adjusted to suit your personal preferences.

1. Press the **MENU** button to display the menu. Press the **▲** or **▼** button to select "Sound", then press the **ENTER** button.
2. Press the **▲** or **▼** button to select "Equalizer", then press the **ENTER** button.
3. Press the **◀** or **▶** button to select a particular item. Press the **ENTER** button.
4. Press the **▲** or **▼** button to reach the required setting. Press the **ENTER** button.
5. Press the **EXIT** button to exit.

➤ If you make any changes to these settings, the Sound Mode is automatically switched to "Custom".

Setting the TruSurround XT (SRS TSXT)

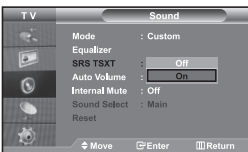

TruSurround XT is a patented SRS technology that solves the problem of playing 5.1 multichannel content over two speakers.

TruSurround delivers a compelling, virtual surround sound experience through any two-speaker playback systems, including internal television speakers. It is fully compatible with all multichannel formats.

1. Press the **MENU** button to display the menu. Press the **▲** or **▼** button to select "Sound", then press the **ENTER** button.
2. Press the **▲** or **▼** button to select "SRS TSXT", then press the **ENTER** button.
3. Press the **▲** or **▼** button to select "On" or "Off". Press the **ENTER** button.
4. Press the **EXIT** button to exit.

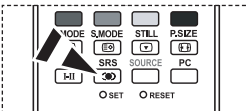

You can also set these options simply by pressing the **SRS** button on remote control.



TruSurround XT, SRS and  symbol are trademarks of SRS Labs, Inc. TruSurround XT technology is incorporated under license from SRS Labs, Inc.

Adjusting the Volume Automatically

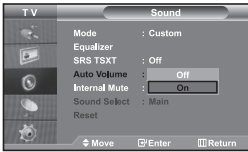

Each broadcasting station has its own signal conditions, and so it is not easy for you to adjust the volume every time the channel is changed. This feature allows you to automatically adjust the volume of the desired channel by lowering the sound output when the modulation signal is high or by raising the sound output when the modulation signal is low.

1. Press the **MENU** button to display the menu. Press the **▲** or **▼** button to select "Sound", then press the **ENTER** button.
2. Press the **▲** or **▼** button to select "Auto Volume", then press the **ENTER** button.
3. Press the **▲** or **▼** button to select "On" or "Off". Press the **ENTER** button.
4. Press the **EXIT** button to exit.

Selecting the Internal Mute

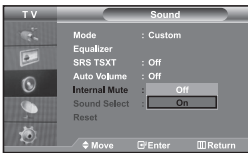

If you want to hear the sound through separate speakers, cancel the internal amplifier.

1. Press the **MENU** button to display the menu. Press the **▲** or **▼** button to select "Sound", then press the **ENTER** button.
 2. Press the **▲** or **▼** button to select "Internal Mute", then press the **ENTER** button.
 3. Press the **▲** or **▼** button to select "On" or "Off". Press the **ENTER** button.
 4. Press the **EXIT** button to exit.
- When "Internal Mute" is set to "On", the Sound menu except for "Sound Select" (in PIP mode) cannot be adjusted.

Listening to the Sound of the Sub Picture

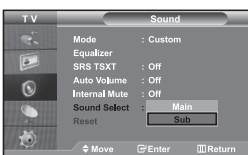

During the PIP features activation, you can listen to the sound of the sub picture.

1. Press the **MENU** button to display the menu. Press the **▲** or **▼** button to select "Sound", then press the **ENTER** button.
2. Press the **▲** or **▼** button to select "Sound Select", then press the **ENTER** button.
3. Press the **▲** or **▼** button to select "Sub". Press the **ENTER** button.
4. Press the **EXIT** button to exit.

- **Main:** Used to listen to the sound of the main picture.
- **Sub:** Used to listen to the sound of the sub picture.

➤ You can select this option when the "PIP" is set to "On".

Resetting the Sound Settings to the Factory Defaults

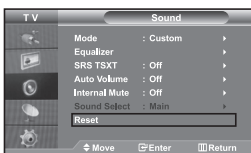

If Game Mode is On, the Reset Sound function is activated. Selecting the Reset function after setting the equalizer resets the equalizer setting to the factory defaults.

1. Press the **MENU** button to display the menu. Press the **▲** or **▼** button to select "Sound", then press the **ENTER** button.
2. Press the **▲** or **▼** button to select "Reset", then press the **ENTER** button.
3. Press the **EXIT** button to exit.

➤ You can select this option when the "Game Mode" is set to "On".

Connecting Headphones



You can connect a set of headphones to your set if you wish to watch a TV programme without disturbing the other people in the room.



- When you insert the head set jack into the corresponding port, you can operate only "Internal Mute" and "Sound Select" (in PIP mode) in Sound menu. (Refer to "Selecting the Internal Mute" on page 18)
- Prolonged use of headphones at a high volume may damage your hearing.
- You will not receive sound from the speakers when you connect headphones to the system.

Selecting the Sound Mode

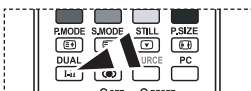

You can also set these options simply by pressing the **DUAL** button on remote control.

You can set the sound mode by pressing the "DUAL" button. When you press it, the current sound mode is displayed on the screen.

	Audio Type	DUAL 1/2	Default
FM Stereo	Mono	MONO	Automatic change
	Stereo	STEREO ↔ MONO	
	Dual	DUAL 1 ↔ DUAL 2	DUAL 1
NICAM Stereo	Mono	MONO	Automatic change
	Stereo	MONO → STEREO	
	Dual	MONO ↔ DUAL 1 DUAL 2 ←	DUAL 1

Setting and Displaying the Current Time

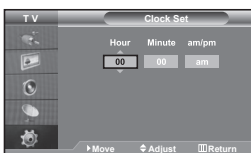

You can set the TV's clock so that the current time is displayed when you press the INFO button. You must also set the time if you wish to use the automatic On/Off timers.

1. Press the **MENU** button to display the menu. Press the **▲** or **▼** button to select "Setup", then press the **ENTER** button.
2. Press the **▲** or **▼** button to select "Time", then press the **ENTER** button.
3. Press the **ENTER** button to select "Clock Set".

To...	Press the...
Move to "Hour" or "Minute", "am/pm"	◀ or ▶ button.
Set the "Hour" or "Minute", "am/pm"	▲ or ▼ button.
Press the ENTER button.	

5. Press the **EXIT** button to exit.
 - If you disconnect the power cord, you have to set the clock again.
 - You can also set hour and minute by pressing the number buttons on the remote control.

Setting the Sleep Timer

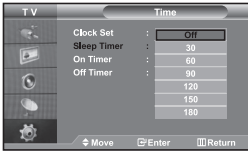

Press the **SLEEP** button on the remote control repeatedly until the appropriate time interval appears.

You can select a time period of between 30 and 180 minutes after which the television automatically switches to standby mode.

1. Press the **MENU** button to display the menu. Press the **▲** or **▼** button to select "Setup", then press the **ENTER** button.
 2. Press the **▲** or **▼** button to select "Time", then press the **ENTER** button.
 3. Press the **▲** or **▼** button to select "Sleep Timer", then press the **ENTER** button.
 4. Press the **▲** or **▼** button repeatedly until the desired time appears (Off, 30, 60, 90, 120, 150, 180). Press the **ENTER** button.
 5. Press the **EXIT** button to exit.
- The TV automatically switches to standby mode when the timer reaches 0.

Switching the Television On and Off Automatically

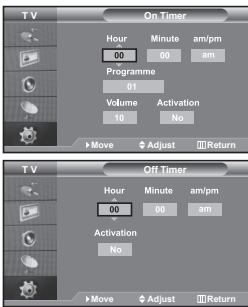

You can set the On/Off timers so that the set will:

◆ **Switch on automatically and tune to the channel of your choice at the time you select.**

◆ **Switch off automatically at the time you select.**

➤ **The first step is to set the television's clock.**

1. Press the **MENU** button to display the menu. Press the **▲** or **▼** button to select "Setup", then press the **ENTER** button.
 2. Press the **▲** or **▼** button to select "Time", then press the **ENTER** button.
 3. Press the **▲** or **▼** button to select "On Timer", then press the **ENTER** button.
 4. Press the **▲** or **▼** button to adjust "Hour", then press the **▶** button to move to the next step. Set other items using the same method as above. When finished, press the **ENTER** button to return.
 5. Press the **▲** or **▼** button to select "Off Timer", then press the **ENTER** button.
 6. Press the **▲** or **▼** button to adjust "Hour", then press the **▶** button to move to the next step. Set other items using the same method as above. When finished, press the **ENTER** button to return.
 7. Press the **EXIT** button to exit.
- You can also set hour and minute by pressing the number buttons on the remote control.
- The "Activation" setting must be set to "Yes" in order for the timers to work.

Choosing Your Language



When you start using your set for the first time, you must select the language which will be used for displaying menus and indications.

1. Press the **MENU** button to display the on-screen menu.
Press the **▲** or **▼** button to select "Setup", then press the **ENTER** button.
2. Press the **▲** or **▼** button to select "Language", then press the **ENTER** button.
3. Select a particular language by pressing the **▲** or **▼** button repeatedly.
Press the **ENTER** button.
➤ You can choose one of 5 languages.
4. Press the **EXIT** button to exit.

Using Game Mode



When connecting to a game console such as PlayStation™ or Xbox™, you can enjoy a more realistic gaming experience by selecting game menu.

1. Press the **MENU** button to display the menu. Press the **▲** or **▼** button to select "Setup", then press the **ENTER** button.
2. Press the **▲** or **▼** button to select "Game Mode", then press the **ENTER** button.
3. Press the **▲** or **▼** button to select "On" or "Off". Press the **ENTER** button.
4. Press the **EXIT** button to exit.
 - To disconnect the game console and connect another external device, set Game to Off in the setup menu.
 - If you display the TV menu in Game mode, the screen shakes slightly.
 - Game Mode is not available in TV mode.
 - If Game Mode is On:
 - Picture Mode and Sound Mode are automatically changed to Custom and users can not change the mode.
 - Adjust the sound using the equalizer.
 - The Reset Sound function is activated. Selecting the Reset function after setting the equalizer resets the equalizer setting to the factory defaults.

Component

 Game Mode

Setting the Blue Screen Mode / Selecting the Melody



Blue Screen:

If no signal is being received or the signal is very weak, a blue screen automatically replaces the noisy picture background. If you wish to continue viewing the poor picture, you must set the "Blue Screen" mode to "Off".

Melody:

You can hear melody sound when the television is powered on or off.

1. Press the **MENU** button to display the menu. Press the **▲** or **▼** button to select "Setup", then press the **ENTER** button.
2. Press the **▲** or **▼** button to select "Blue Screen" or "Melody". Press the **ENTER** button.
3. Press the **▲** or **▼** button to select "On" or "Off". Press the **ENTER** button.
4. Press the **EXIT** button to exit.

Using the Energy Saving Feature



This function adjusts the brightness of the TV so as to reduce power consumption. When you watching TV at night, set the "Energy Saving" mode option to "High" so as to reduce the dazzling of your eyes as well as the power consumption.

1. Press the **MENU** button to display the on-screen menu. Press the **▲** or **▼** button to select "Setup", then press the **ENTER** button.
2. Press the **▲** or **▼** button to select "Energy Saving", then press the **ENTER** button.
3. Select the required option (Off, Low, Medium, High) by pressing the **▲** or **▼** button. Press the **ENTER** button.
4. Press the **EXIT** button to exit.

Setting the Blue Eye

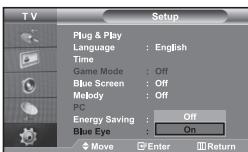

You can set the power of Blue LED to be on. If the power is off when Blue Eye TV is off, the Blue LED goes off. This will save power and reduce eye fatigue.

1. Press the **MENU** button to display the on-screen menu. Press the **▲** or **▼** button to select "Setup", then press the **ENTER** button.
2. Press the **▲** or **▼** button to select "Blue Eye", then press the **ENTER** button.
3. Press the **▲** or **▼** button to select "On" or "Off". Press the **ENTER** button.
 - Off: LED(Blue) will not come on.
 - On: LED(Blue) will come on after you turn the TV off.
4. Press the **EXIT** button to exit.

Selecting the Source

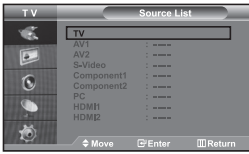

You can select among external sources connected to your TV's input jacks.

1. Press the **MENU** button to display the menu.
Press the **ENTER** button, to select "Input".
2. Press the **ENTER** button again, to select "Source List".
➤ When no external device is connected to your set, only "TV" are activated in the "Source List"; "AV1", "AV2", "S-Video", "Component1", "Component2", "PC", "HDMI1", "HDMI2" are activated only when they are connected to your set.
3. Select the required device by pressing the **▲** or **▼** button.
Press the **ENTER** button.

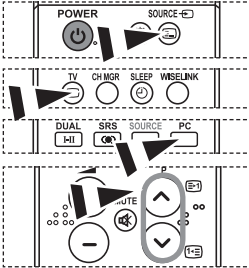

Press the **SOURCE** button on the remote control to toggle between all the available source. TV mode can be selected by pressing the **TV** button, number buttons(0~9), and the **PC** button on the remote control. But it cannot be selected using the **SOURCE** button.

You can select PC mode by simply pressing the **PC** button on the remote control.

Editing the Input Source Names

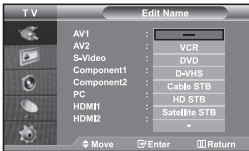

Name the device connected to the input jacks to make your input source selection easier.

1. Press the **MENU** button to display the menu.
Press the **ENTER** button, to select "Input".
2. Press the **▲** or **▼** button to select "Edit Name", then press the **ENTER** button.
3. Press the **▲** or **▼** button to select the device that you wish to edit.
Press the **ENTER** button.
4. Press the **▲** or **▼** button to select the required device.
Press the **ENTER** button.
5. Press the **EXIT** button to exit.

Using the WISELINK Function

You can view stored photos (JPEG files) or play music files (MP3) using a memory card or USB storage media.

- The "Photo" menu supports image files in the JPEG format only.
- The "Music" menu supports sound files in the MP3 format only.

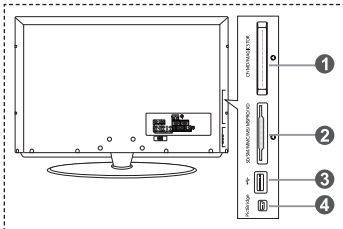

- 1 **Compact Flash (CF) / Micro Driver (MD) / MAGICSTOR**
- 2 **Secure Digital Card (SD Card) / Smart Media Card (SM) / Multimedia Card (MMC) / Memory Stick / MSPRO / XD**
- 3 **USB Mass Storage Class**
 - The USB hub type is not available because using the Half-Speed USB can cause the hardware limitation. (Only the Full-Speed USB is available.)
- 4 **Photo Printer**

1. First, connect the memory card or USB storage media containing your files to the WISELINK terminal on the side of the TV.

Supported Memory Cards

Compact Flash (CF)	Micro Drive (MD)	MAGICSTOR	Secure Digital Card (SD Card)	Smart Media Card
Multimedia Card (MMC)	Memory Stick	MSPRO	XD	

➤ Some types of Memory Cards or USB hosts, depending on the manufacturer, may not be supported.

2. Using the Remote Control Button in WISELINK Menu

Button	Operations
	Move the cursor and select an item.
	Select the currently selected item.
PLAY/PAUSE	Play or pause the Slide Show or MP3 file.
EXIT	Stop the current function and return to the previous high-level menu.
INFO	Run various functions from the Photo and Music menus.
STOP	Stop the current slide show or MP3 file.
REW / FF	Page Up or Down (file list item)
MENU	Return to the previous menu

Using the WISELINK Menu



This menu shows JPEG and MP3 files and folders saved on a memory card.

1. Press the **MENU** button to display the menu. Press the **ENTER** button, to select "Input".
 - If the "Insert memory cards." message is displayed, check whether the memory card is correctly inserted into the WISELINK terminal on the side of the TV.
2. Press the **▲** or **▼** button to select "WISELINK", then press the **ENTER** button.
 - A menu for selecting the format of the files saved on the selected Memory Card will be displayed.
3. Press the **▲** or **▼** button to select the corresponding Memory Card, then press the **ENTER** button.
 - A menu for selecting the format of the files saved on the selected Memory Card will be displayed.
4. Press the **◀** or **▶** button to move to an item, then press the **ENTER** button.
5. To exit WISELINK, press the **WISELINK** button on the remote control.



 You can select these options by simply pressing the **WISELINK** button on the remote control.

Using the PHOTO (JPEG) List

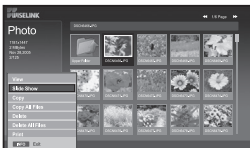

This menu shows JPEG files and folders saved on a memory card.

1. Complete Steps 1 to 4 of "Using the WISELINK Menu".
2. Press the **◀** or **▶** button to select "Photo", then press the **ENTER** button.
 - The saved file information is displayed as a folder or file.
3. Press the **▲**, **▼**, **◀** and **▶** buttons to select a file, then press the **ENTER** button.
 - Pressing the button over a photo icon shows the currently selected photo in full screen.
 - Pressing the button over a folder icon shows the JPEG files included in the folder.
 - The Menu is displayed. Select the View option to display a photo in the aspect ratio.
4. Press the **INFO** button to configure the options.
 - When the Photo List screen is displayed: "View", "Slide Show", "Copy", "Copy All files", "Delete", "Delete All Files", "Print"
 - When a full screen is displayed: "Slide Show", "Rotate", "Zoom", "Copy", "Delete", "Print", "List"
5. To exit WISELINK, press the **WISELINK** button on the remote control.
 - Moving to another photo may take a few seconds to load the file. At this point, the  icon will appear at the top left of the screen.
 - This menu only shows files whose file extension is JPEG. Files of other formats such as bmp or tiff will not be displayed.
 - The files are displayed on a page. 15 thumbnail photos are displayed per page.
 - The thumbnails are numbered from left to right and from top to bottom, from 1 to 15.
 - Folders are displayed first and they are followed by all JPEG files in the current folder. The folders and JPEG files are sorted in alphabetical order.

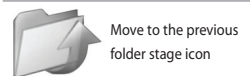
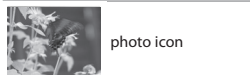
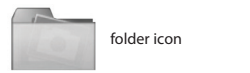

 You can select these options by simply pressing the **WISELINK** button on the remote control.

Using the Options Menu



"Slide Show":

Starts a slide show.

(Refer to "Selecting a Photo and Slide Show" on page 27)



"Rotate":

You can rotate images in full screen mode.

Images are rotated in the order of 90°, 180°, 270° and 0° (original state).

(Refer to "Rotating" on page 28)

➤ You cannot save a rotated image.



"Zoom":

You can zoom into images in full screen mode.

Images are zoomed in on in the order of X2, X3, X4 and X1 (original size).

(Refer to "Zooming-in" on page 29)

➤ You cannot save a zoomed-in on image.

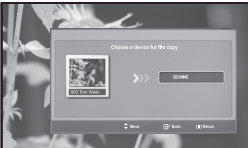

"Copy", "Copy All files":

You can copy image files to a different memory card.

(Refer to "Copying Image Files" on page 30)



"Delete", "Delete All Files":

You can delete selected image files.

(Refer to "Deleting Image Files" on page 30)



"Print":

You can print image files directly with your printer.

(Refer to "Printing a Photo" on page 31)



"List":

Displays the stored files and folders and file info.

- The "File Error" message appears on the screen in the following situations:
- When the file actually has an error
 - If the target memory cannot be written to when copying files
 - If the target memory has not enough space when copying files

Viewing Photo File Information



When selecting a photo file, the photo file information is displayed on the left in the TV screen, such as the resolution, the date modified and the order of the file in the current directory.



- ① Such as the resolution
- ② File size
- ③ Date modified
- ④ Order of the file in the current directory

Selecting a Photo and Slide Show



This menu shows JPEG files and folders saved on a memory card.

1. Complete Steps 1 to 4 of "Using the WISELINK Menu".(Refer to page 25)
2. Press the ◀ or ▶ button to select "Photo", then press the **ENTER** button.
 - The saved file information is displayed as a folder or file.
3. Press the **INFO** button.
4. Press the ▲ or ▼ button to select "Slide Show", then press the **ENTER** button.
 - The Menu is displayed. Select the View option to display a photo in the aspect ratio.
 - Slide Show all files in the selected folder at a predetermined interval.
 - During the Slide Show, files are displayed in order from the currently shown file.
5. Press the **INFO** button during "Slide Show" to set the option ("Speed", "Background Music", "Background Music Setting", "List"). Press the ▲ or ▼ button to select the option, then press the **ENTER** button.
6. To change the sub option, press the **INFO** button again to open the options window and select option you want to change, then press the **ENTER** button. Whenever you do this, the sub option on the screen is changed.
7. To exit WISELINK, press the **WISELINK** button on the remote control.
 - If the Slide Show feature is selected when a photo is displayed in full screen, other photos are also in the full screen size during the Slide Show.



You can select these options by simply pressing the **WISELINK** button on the remote control.

Using the Menu during a Slide Show



"Speed":

Select to control the slide show speed.

Press the **ENTER** button to select the option "Normal", "Slow", or "Fast".

- When the Speed feature is set to the Fast option, usually it takes about 7 seconds to slide to the next photo. The loading time may be longer depends on the size of the file.



"Background Music":

Select to determine whether to play an MP3 file during a slide show.

Press the **ENTER** button to select the option "On" or "Off".

- Set the Background Music Settings first to use the "On" or "Off" function in this menu.

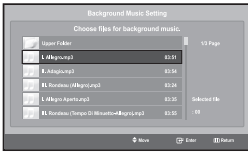

"Background Music Setting":

The saved file information is displayed as folder or MP3 file.

1. Select the "Background Music Settings" and press the **ENTER** button. Navigate to the folder that contains the MP3 files to use as the background music. Select an MP3 file and press **ENTER** button.
 - The selected file is displayed in yellow.
2. **MENU** button again to return to the Slide Show screen. The selected background music is played.
 - If you turn Off the Background Music, even if the Background Music Settings have been set up, the background music will not be played.
 - MP3 files can be automatically played during the Slide Show if the Default Background Music is set to On. To enable this function, MP3 files and other photo files must be located in the same folder.



"List":

Displays the stored files and folders and file info.

Rotating



Displays a 90°, 180°, or 270° rotated image in full screen mode.

1. Complete Steps 1 to 4 of "Using the WISELINK Menu". (Refer to page 25)
2. Press the ◀ or ▶ button to select "Photo", then press the **ENTER** button.
 - The saved file information is displayed as a folder or file.
3. Press the ▲, ▼, ◀ and ▶ buttons to select a file, then press the **ENTER** button.
 - Pressing the button over a photo thumbnail displays the photo in full screen.
 - The Menu is displayed. Select the View option to display a photo in the aspect ratio.
4. Press the **INFO** button to display the option ("Slide Show", "Rotate", "Zoom", "Copy", "Delete", "Print", "List"). Press the ▲ or ▼ button to select "Rotate", then press the **ENTER** button. Press the **ENTER** button to select the option (90°, 180°, 270°, 0°(Original))

To rotate a photo, press the **INFO** button to open the options window, select the "Rotate" option and press the **ENTER** button. Whenever you do this, the photo on the screen is gradually rotated.

5. To exit WISELINK, press the **WISELINK** button on the remote control.
 - The rotated file is not saved.
 - This feature is also available for the photo in the aspect ratio.

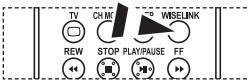

You can select these options by simply pressing the **WISELINK** button on the remote control.

The Rotating function information

Current OSD	Function
	To rotate a photo by 90 degrees
	To rotate a photo by 180 degrees
	To rotate a photo by 270 degrees
	To rotate a photo by original

Zooming-in



You can select these options by simply pressing the **WISELINK** button on the remote control.

Displays a 2x, 3x or 4x zoomed-in image in full screen mode.

- Complete Steps 1 to 4 of "Using the WISELINK Menu". (Refer to page 25)
- Press the ◀ or ▶ button to select "Photo", then press the **ENTER** button.
 - The saved file information is displayed as a folder or file.
- Press the ▲, ▼, ◀ and ▶ buttons to select a file, then press the **ENTER** button.
 - Pressing the button over a photo thumbnail displays the photo in full screen.
 - The Menu is displayed. Select the View option to display a photo in the aspect ratio.
- Press the **INFO** button to display the option ("Slide Show", "Rotate", "Zoom", "Copy", "Delete", "Print", "List"). Press the ▲ or ▼ button to select "Zoom", then press the **ENTER** button. Press the **ENTER** button to select the option ("X2", "X3", "X4", "X1").

To zoom into a photo, press the **INFO** button to open the Options window, select the "Zoom" option and press the **ENTER** button.

Whenever you do this, the following zoom options are applied in sequence.

- X2: Zoom-in to the photo X2.
- X3: Zoom-in to the photo X3.
- X4: Zoom-in to the photo X4.
- X1: Restore the photo to its original size.

To move to pan up/down/left/right, press the ▲, ▼, ◀ and ▶ buttons.

- To exit WISELINK, press the **WISELINK** button on the remote control.

Zoom function information

Current OSD	Function	
		Zoom-in to a photo X2.
		Zoom-in to a photo X3.
		Zoom-in to a photo X4.
		Restore a photo to its original size.
Button	Function	
	Pan Down	Pan down to view the lower part of a zoomed-in photo.
	Pan Up	Pan up to view the upper part of a zoomed-in photo.
	Pan Right	Pan right to view the right side of a zoomed-in photo.
	Pan Left	Pan left to view the left side of a zoomed-in photo.

- This feature is also available for the photo in the aspect ratio.

Copying Image Files

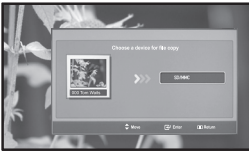
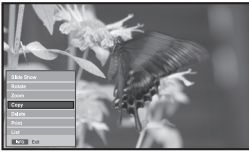

You can select these options by simply pressing the **WISELINK** button on the remote control.

You can copy image files to a different memory card.

1. Complete Steps 1 to 4 of "Using the WISELINK Menu". (Refer to page 25)
2. Press the ◀ or ▶ button to select "Photo", then press the **ENTER** button.
 - The saved file information is displayed as a folder or file.
3. Press the ▲, ▼, ◀ and ▶ buttons to select a file, then press the **ENTER** button.
 - Pressing the button over a photo thumbnail displays the photo in full screen.
 - The Menu is displayed. Select the View option to display a photo in the aspect ratio.
4. Press the **INFO** button to display the option ("Slide Show", "Rotate", "Zoom", "Copy", "Delete", "Print", "List"). Press the ▲ or ▼ button to select "Copy", then press the **ENTER** button.
 - To copy all photos, select the **INFO** button in the Photo List screen and then select the "Copy All Files" menu.
 - If there is no target memory card inserted, the "There is no device connected." message is displayed and no operation follows.
5. To exit WISELINK, press the **WISELINK** button on the remote control.

Deleting Image Files

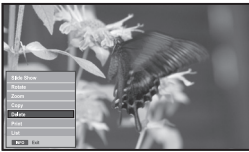

You can select these options by simply pressing the **WISELINK** button on the remote control.

You can delete selected image files.

1. Complete Steps 1 to 4 of "Using the WISELINK Menu". (Refer to page 25)
2. Press the ◀ or ▶ button to select "Photo", then press the **ENTER** button.
 - The saved file information is displayed as a folder or file.
3. Press the ▲, ▼, ◀ and ▶ buttons to select a file, then press the **ENTER** button.
 - Pressing the button over a photo thumbnail displays the photo in full screen.
 - The Menu is displayed. Select the View option to display a photo in the aspect ratio.
4. Press the **INFO** button to display the option ("Slide Show", "Rotate", "Zoom", "Copy", "Delete", "Print", "List"). Press the ▲ or ▼ button to select "Delete", then press the **ENTER** button.
 - To delete all photos, select the **INFO** button in the Photo List screen and then select the "Delete All Files" menu.
 - When selecting the "Delete" or "Delete All Files" menu, an OSD screen is displayed to confirm the deletion. To cancel the deletion, select "No."
5. To exit WISELINK, press the **WISELINK** button on the remote control.

Printing a Photo

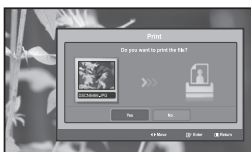

You can select these options by simply pressing the **WISELINK** button on the remote control.

You can print image files directly with your printer.

- Complete Steps 1 to 4 of "Using the WISELINK Menu". (Refer to page 25)
- Press the ◀ or ▶ button to select "Photo", then press the **ENTER** button.
 - The saved file information is displayed as a folder or file.
- Press the ▲, ▼, ◀ and ▶ buttons to select a file, then press the **ENTER** button.
 - Pressing the button over a photo thumbnail displays the photo in full screen.
 - The Menu is displayed. Select the View option to display a photo in the aspect ratio.
- Press the **INFO** button to display the option ("Slide Show", "Rotate", "Zoom", "Copy", "Delete", "Print", "List"). Press the ▲ or ▼ button to select "Print", then press the **ENTER** button.
 - If no printer is connected, the "Check the printer" message is displayed and no operation follows.
- To exit WISELINK, press the **WISELINK** button on the remote control.
 - Connect to the photo printer with the PictBridge feature to print pictures.

Using the MP3 List

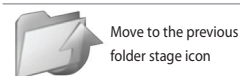
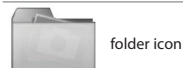
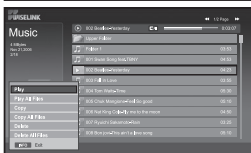
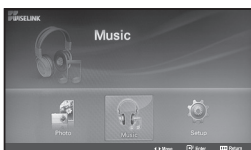





You can select these options by simply pressing the **WISELINK** button on the remote control.

This menu shows MP3 files from among the files saved on the memory card.

- Complete Steps 1 to 4 of "Using the WISELINK Menu". (Refer to page 25)
- Press the ◀ or ▶ button to select "Music", then press the **ENTER** button.
 - The saved file information is displayed as a folder or file.
- Press the ▲ or ▼ button to select a file, then press the **ENTER** button. To select all files or a file, press the **INFO** button to display the Music menus. ("Play", "Play All Files", "Copy", "Copy All Files", "Delete", "Delete All Files") Press the **ENTER** button to select "Play All Files" or "Play".
 - Pressing the **ENTER** button over a musical note icon immediately plays the music file.
 - Pressing the **ENTER** button over a folder icon shows the music files included in the folder.

To select a file on the next page, press the **REW** ◀ or **FF** ▶ button to move to the next page.
- Press the **PLAY/PAUSE** ⏸ button while playing an MP3 file to pause the file. Press the **STOP** ⏹ button to exit Play mode.
- To exit WISELINK, press the **WISELINK** button on the remote control.
 - This menu only shows files with the MP3 file extension. Files with other file extensions are not displayed, even if they are saved on the same memory card.
 - The selected file is displayed on the top with its playing time.
 - To adjust the music volume, press the ◀ or ▶ button on the remote control. To mute the sound, press the **MUTE** 🔇 button on the remote control.

Music function information		
Current OSD		Function
	(Music) Play/Pause	When pressing the PLAY/PAUSE  button on the remote control while music is playing.
	(Music) Stop	When pressing the STOP  button on the remote control when music is stopped.

Copying Music Files

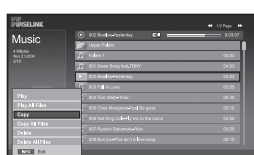

You can select these options by simply pressing the **WISELINK** button on the remote control.

You can copy music files to a different memory card.

- Complete Steps 1 to 4 of "Using the WISELINK Menu". (Refer to page 25)
- Press the **◀** or **▶** button to select "Music", then press the **ENTER** button.
 - The saved file information is displayed as a folder or file.
- Press the **▲** or **▼** button to select a file, then press the **ENTER** button. To select all files or a file, press the **INFO** button to display the Music menus. ("Play", "Play All Files", "Copy", "Copy All Files", "Delete", "Delete All Files")
 - Press the **ENTER** button to select "Copy" or "Copy All Files".
 - If no target memory card is inserted, the "There is no device connected." message is displayed and no operation follows.
- To exit WISELINK, press the **WISELINK** button on the remote control.

Deleting Music Files

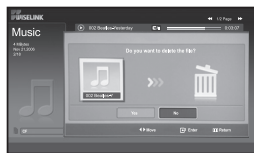

You can select these options by simply pressing the **WISELINK** button on the remote control.

You can delete selected music files.

- Complete Steps 1 to 4 of "Using the WISELINK Menu".(Refer to page 25)
- Press the **◀** or **▶** button to select "Music", then press the **ENTER** button.
 - The saved file information is displayed as a folder or file.
- Press the **▲** or **▼** button to select a file, then press the **ENTER** button. To select all files or a file, press the **INFO** button to display the Music menus. ("Play", "Play All Files", "Copy", "Copy All Files", "Delete", "Delete All Files")
 - Press the **ENTER** button to select "Delete" or "Delete All Files".
 - When selecting the "Delete" or "Delete All Files" menu, an OSD screen is displayed to confirm the deletion. To cancel the deletion, select "No."
- To exit WISELINK, press the **WISELINK** button on the remote control.

Using the Setup Menu



You can select these options by simply pressing the **WISELINK** button on the remote control.

Setup displays the user settings of the WISELINK menu.

1. Complete Steps 1 to 4 of "Using the WISELINK Menu". (Refer to page 25)
2. Press the ◀ or ▶ button to select "Setup", then press the **ENTER** button.
➤ The saved file information is displayed as a folder or file.
3. Press the ▲ or ▼ button to select an item you want, then press the **ENTER** button.
4. Press the ▲ or ▼ button to select the option, then press the **ENTER** button.
5. To exit WISELINK, press the **WISELINK** button on the remote control.

"Slide Show Speed":

Select to control the slide show speed.

"Slide Show Effect":

You can select effects to use with the slide show.

"Slide Show Repeat":

- On: Repeats the slide show from the beginning when all the files in the folder have been displayed.
- Off: Exit a slide show.
To return to the Photo menu when all the files in the folder have been displayed.

"Music Repeat":

Select to determine whether to repeat playing the music when all MP3 files in the current folder have been played.

"Background Music":

Select to determine whether to play an MP3 file during a slide show.

"Background Music Setting":

You can select the background music to play during a slide show. You can also select the background music while a slide show is in process by pressing the **INFO** button and selecting the "Background Music Setting" menu.

"Screen Saver":

Select to set the waiting time before the screen saver is run when no button is pressed.

Teletext Decoder

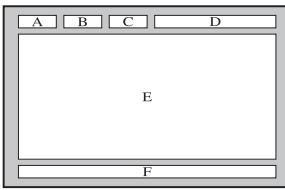

Most set channels carry "Teletext", pages of written information that provide information such as:

- ◆ Television programme times.
- ◆ News bulletins and Weather forecasts.
- ◆ Sports results.
- ◆ Subtitles for the hard of hearing.

The Teletext pages are organized according to six categories:

Part	Contents
A	Selected page number.
B	Broadcasting station identity.
C	Current page number or search status.
D	Date and time.
E	Text.
F	Status information.

Displaying the Teletext Information

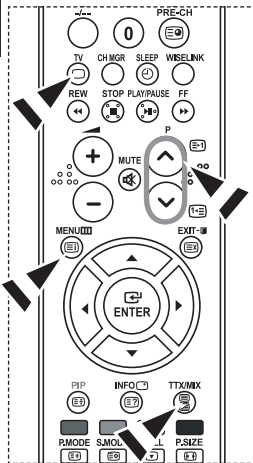

You can display Teletext information at any time, but signal reception must be good. Otherwise:

- ◆ Information may be missing.
- ◆ Some pages may not be displayed.

To activate the Teletext mode and display the contents page:

1. Using the **P** (⏻) or **P** (⏮) button, select the channel providing the Teletext service.
2. Press the **TTX/MIX** (Ⓜ/Ⓜ) button to activate the Teletext mode.
 - The contents page is displayed. It can be redisplayed at any time by pressing the **MENU** (Ⓜ) button.
3. Press the **TTX/MIX** (Ⓜ/Ⓜ) button again.
 - The actual broadcast will be displayed with "Teletext", "Double", and "Mix" in order on the screen.
4. Press the **TV** (Ⓜ) button to exit from the Text display.
 - If any broken character appears while Text is being viewed, make sure that the Text language is identical with the language in the "Setup" menu mode. If both languages are different, select the same language with the Text language on the "Setup" menu.

Selecting a Specific Teletext Page

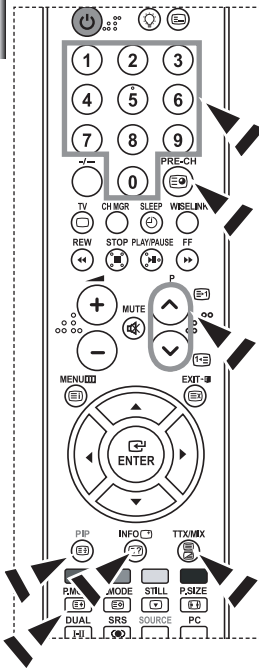

Press the number buttons on the remote control to enter the page number directly:

1. Enter the three-digit page number listed in the contents by pressing the corresponding numeric buttons.
2. If the selected page is linked with several secondary pages, the secondary pages are displayed in sequence. To freeze the display on a given page, press the **PIP** (PIP) button. Press the **PIP** (PIP) button again to resume.
3. Using the various display options:

To display...	Press the...
Both Teletext information and the normal broadcast	TTX/MIX (TTX/MIX)
Hidden text (answers to quiz games, for example)	INFO (INFO)
The normal screen	INFO (INFO)
A secondary page, by entering its 4-digit number	PRE-CH (PRE-CH)
The next page	P (P)
The previous page	P (P)
Double-size letters in the: <ul style="list-style-type: none"> • Upper half of the screen • Lower half of the screen 	P.MODE (P.MODE) <ul style="list-style-type: none"> • Once • Twice
Normal screen	• Three times

Using Fastext to Select a Teletext Page

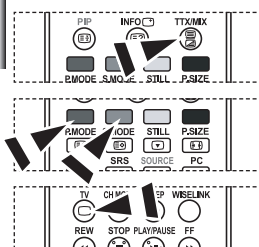

The various topics included in the Teletext pages are colour-coded, and can be selected by pressing the coloured buttons on the remote control.

1. Display the Teletext contents page by pressing the **TTX/MIX** (TTX/MIX) button.
2. Press the coloured button corresponding to the topic that you wish to select (The available topics are listed on the status information line).
3. Press the Red button to display the previous page. Press the Green button to display the next page.
4. Press the **TV** (TV) button to exit from the Text display.

Setting Up Your Remote Control

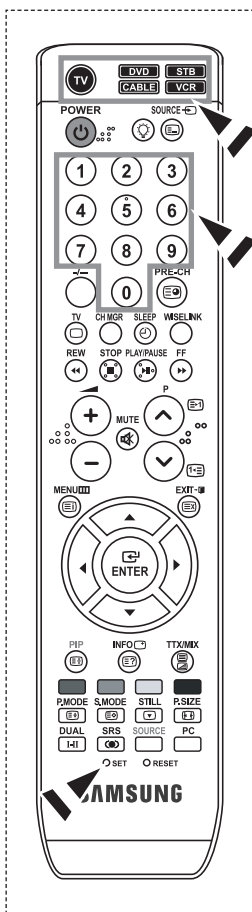

After it has been set up properly, your remote control can operate in five different modes: TV, DVD, Cable, Set-Top Box, VCR. Pressing the corresponding button on the remote control allows you to switch between these modes, and control whichever piece of equipment you choose.

➤ The remote control might not be compatible with all DVD Players, VCRs, Cable boxes, and Set-Top Boxes.

Setting Up the Remote to Operate Your VCR

1. Turn off your VCR.
2. Press the **VCR** button on your TV's remote control.
3. Press the **SET** button on your TV's remote control.
4. Using the number buttons on your remote control, enter three digits of the VCR code listed on page 38 of this manual for your brand of VCR. Make sure you enter three digits of the code, even if the first digit is a "0". (If more than one code is listed, try the first one.)
5. Press the **POWER** button on the remote control. Your VCR should turn on if your remote is set up correctly. If your VCR does not turn on after set up, repeat steps 2, 3, and 4, but try one of the other codes listed for your brand of VCR. If no other codes are listed, try each VCR code, 000 through 080.

➤ Note on Using Remote Control Modes: VCR

When your remote control is in "VCR" mode, the volume buttons still control your TV's volume.

Setting Up the Remote to Operate Your Cable Box

1. Turn off your cable box.
2. Press the **CABLE** button on your TV's remote control.
3. Press the **SET** button on your TV's remote control.
4. Using the number buttons on your remote control, enter three digits of the cable box code listed on page 39 of this manual for your brand of cable box. Make sure you enter three digits of the code, even if the first digit is a "0". (If there is more than one code listed, try the first one.)
5. Press the **POWER** button on the remote control. Your cable box should turn on if your remote is set up correctly. If your cable box does not turn on after set up, repeat steps 2, 3, and 4, but try one of the other codes listed for your brand of cable box. If no other codes are listed, try each code, 000 through 046.

➤ Note on Using Remote Control Modes: Cable Box

When your remote control is in "CABLE" mode, the volume buttons still control your TV's volume.

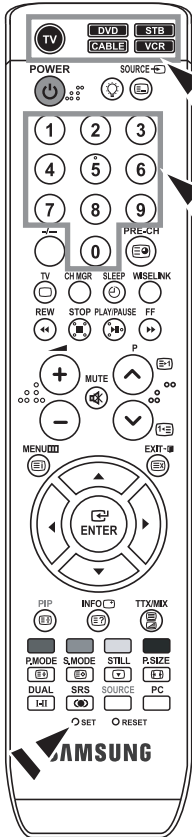

Setting Up the Remote to Operate Your DVD

1. Turn off your DVD.
 2. Press the **DVD** button on your TV's remote control.
 3. Press the **SET** button on your TV's remote control.
 4. Using the number buttons on your remote control, enter three digits of the DVD code listed on page 39~40 of this manual for your brand of DVD. Make sure you enter three digits of the code, even if the first digit is a "0". (If there is more than one code listed, try the first one.)
 5. Press the **POWER** button on the remote control. Your DVD should turn on if your remote is set up correctly. If your DVD does not turn on after set up, repeat steps 2, 3, and 4, but try one of the other codes listed for your brand of DVD. If no other codes are listed, try each code, 000 through 141.
- Note on Using Remote Control Modes: DVD
When your remote control is in "DVD" mode, the volume buttons still control your TV's volume.

Setting Up the Remote to Operate Your STB

1. Turn off your STB.
 2. Press the **STB** button on your TV's remote control.
 3. Press the **SET** button on your TV's remote control.
 4. Using the number buttons on your remote control, enter three digits of the STB code listed on page 40 of this manual for your brand of STB. Make sure you enter three digits of the code, even if the first digit is a "0". (If there is more than one code listed, try the first one.)
 5. Press the **POWER** button on the remote control. Your STB should turn on if your remote is set up correctly. If your STB does not turn on after set-up, repeat steps 2, 3 and 4, but try one of the other codes listed for your brand of STB. (If no other codes are listed, try each code, 000 through 074.)
- Note on Using Remote Control Modes: STB
When your remote control is in "STB" mode, the volume buttons still control your TV's volume.

Remote Control Codes

> VCR

Brand	Code
SAMSUNG	000 001 002 003 004 005 077 078 079
ADMIRAL	020
AIWA	025
AKAI	004 027 032
AUDIO DYNAMICS	007 026
BELL&HOWELL	018
BROKSONIC	022
CANDLE	002 003 006 008 015 055
CANON	021 056
CITIZEN	002 003 006 008 015 055
Colour TYME	007
CRAIG	002 024
CURTIS MATHES	002 007 008 017 021 025 056 064 066
DAEWOO	003 010 011 012 013 014 015 016
DB	007 026
DIMENSIA	017
DYNATECH	025
ELECTROHOME	034
EMERSON	001 003 006 021 022 025 030 032 034 040 047 050 052 060 063 065 066 067 069 073
FISHER	018 024 028 029 048 051 061
FUNAI	025
GENERAL ELECTRIC	002 005 017 021 056
GO VIDEO	002
HARMAN KARDON	007
HITACHI	019 025 041 042 074
INSTANT REPLAY	021
JC PENNEY	002 007 018 019 021 026 037 041 054 056
JCL	007 008 018 021 026 037
JVC	081 082 083
KENWOOD	007 008 018 021 026 037
KLH	070
KONIA	036
LG(Goldstar)	006 007 008 009 010
LLOYD	025
LOGIK	038
LXI	025
MAGNAVOX	021 056 059
MARANTZ	007 008 018 021 026 037 062
MARTA	006
MEI	021
MEMOREX	006 021 024 025
MGA	034
MIDLAND	005
MINOLTA	019 041 075
MITSUBISHI	019 034 041 046

Brand	Code
MONTGOMERY WARD	020
MTC	002 025
MULTITECH	002 005 025 038
NEC	007 008 018 026 037 062 064
OPTIMUS	020
ORION	073 074 075 076
PANASONIC	021 056 071 072
PENTAX	019 041 075
PENTEX RESEARCH+	008
PHILCO	021 056 059
PHILIPS	021 080
PIONEER	019 026 039 053
PORTLAND	015 049 055
PROSCAN	017
QUARTZ	018
QUASAR	021 056
RADIO SHACK/ REALISTIC	006 018 020 021 024 025 029 034 048 056
RCA	002 017 019 021 035 041 043 057 068 076
SANSUI	026
SANYO	018 024
SCOTT	003 047 052 067
SEARS	006 018 019 024 028 029 041 048 051
SHARP	020 034 045 015
SHIMTOM	027 033 038 058
SIGNATURE	025
SONY	027 033 044
SYLVANIA	021 025 056 059
SYMPHONIC	025
TANDY	018 025
TASHIKA	006
TATUNG	037
TEAC	025 037 068
TECHNICS	021
TEKNIKA	006 021 025 031
TMK	066
TOSHIBA	003 019 029 051 052
TOTEVISION	002 006
UNITECH	002
VECTOR RESEARCH	007 026
VICTOR	026
VIDEO CONCEPTS	007 026
VIDEOSONIC	002
WARDS	002 003 006 019 020 021 024 025 034 038 041
YAMAHA	007 008 018 026 037
ZENITH	023 027 033

➤ **CABLE BOX**

Brand	Code
SAMSUNG	000 001 002 003 004 005 006 007
GI	041
HAMLIN	003 024 031
HITACHI	025 030
JERROLD	038 039
MACOM	025 030
MAGNAVOX	019 023 028
OAK	026
PANASONIC	003 022 027 037 044
PHILIPS	019 021 023 028
PIONEER	004 018 020 044
RCA	014 022 040
REGAL	003

➤ **SAMSUNG DVD**

Product	Code
DVD	000 001 002
DVDR	003 004
BD Record	005 006
VCR COMBO	007 008 009 010 011
VCR Record	012
DHR COMBO	013

➤ **DVD**

Brand	Code
ANAM	030
AUDIOVOX	075
AUDIOLOGIC	085
ANABA	072
APEX DIGITAL	070 071 074 086 083 084 088 111 112
AIWA	114
BROKSONIC	062
BLAUPUNKT	074
B&K	122 123
CURTIS MATHES	027
CYBER HOME	077 078 079 082
CLARION	080 125
CIRRUS	081
CYBER HOME	065
CINEVISION	095
DAEWOO	066
DENON	146
FARENHEIT	067 068
FISHER	090
GPX	060
GO VIDEO	061 089 133 135
GE	069 074
GREENHILL	074
HITACHI	064 113
HITEKER	071
HOYO	073
HARMAN / KARDON	091 110
IRT	089

Brand	Code
REGENCY	015 023
SA	042 043
SCIENTIFIC ATLAN	042 043
SPRUCER	022
STARGATE 2000	036
SYLVANIA	016
TEXSCAN	016
TOCOM	032
UNIVERSAL	033 034
VIEWSTAR	019 021 023 028
WARNER AMEX	046
ZENITH	017 029 035 037 045

Product	Code
Home Theater VCR COMBO	014 015 016
HDD Recorder COMBO	017
TWIN TRAY COMBO	018
STB DVD COMBO	019
DVD Receiver	020
AV Receiver	021

Brand	Code
INTEGRA	092
JBL	091
JVC	022 033 115 116
JATON	073
KENWOOD	051 108 109
KISS	073
KONKA	059 100 106 107
KLH	074 075
LG(Goldstar)	025 031
LOEWE	057
LASONIC	058
MOBILE AUTHORITY	054
MEMOREX	055
MALATA	056
MAGNAVOX	076 093
MINTEK	074 094
MONYKA	073
NORCENT	048 049 050
NEXT BASE	052
NEC	053
NANTAUS	144
NESA	074
OPTOMEDIA ELECTRONICS	105
OPTIVIEW	072
ONKYO	076 092 119
PHILCO	044 045
PRINCETON	046 047
PROSCAN	023

➤ DVD

Brand	Code
PANASONIC	024 034 124 134 136 137 138
PHILIPS	036 076
ROTEL	117 118
RIO	120
RCA	023 035 074 075 131 132
RAITE	073
ROWA	038
SAMPO	104
SONY	026 029 126 127 128 129 130 141
SHERWOOD	039 041
SVA	042
SYLVANIA	043 093
SHARP	140
SANSUI	062
SANYO	062 090
SHINSONIC	094

➤ SAMSUNG SET-TOP BOX

Product	Code
Ground wave STB	001 002
Satellite STB	003
CABLE STB	004
STB DVD COMBO	008
Satellite STB HDD COMBO Standard	009

➤ SET-TOP BOX

Brand	Code
ALPHASTAR	023
ANAM	043
CHANNEL MASTER	018 034
CROSSDIGITAL	019
CHAPARRAL	035
DIRECT TV	015 016 017 019 022 045 060 061 062 065 066 067 068
DAEWOO	074
DISH NETWORK SYSTEM	069 070
DISHPRO	069
DRAKE	018 024 032
DX ANTENNA	027
ECHOSTAR	025 069 070 071
EXPRESSVU	069
GOI	069
GE	065
GENERAL INSTRUMENT	046 047 048 063 064
HTS	069
HOME CABLE	056
HITACHI	022
HUGHES NETWORK	015 017
IQ	020
IQ PRISM	020
JANEIL	059
JERROID	063
JVC	069 070
LG(Goldstar)	044 073

Brand	Code
THOMSON	145
TOSHIBA	028 062 076
TECHNICS	139
TVIEW	072
TOKAI	073
TEAC	096
TECHWOOD	097
TREDEX	098 099 101
URBAN CONCEPTS	076
VENTURER	075
VOCOPRO	102
YAMAHA	032 063
YAMAKAWA	040 073
XWAVE	103
ZENITH	076 121

Product	Code
Satellite STB HDD COMBO Premium	010
CABLE STB HDD COMBO Standard	011
CABLE STB HDD COMBO Premium	012
Ground wave STB HDD COMBO Standard	013
Ground wave STB HDD COMBO Premium	014

Brand	Code
MAGNAVOX	016 021 036 038 039 040 041 042
MEMOREX	016
MOTOROLA	064
MACOM	018
MITSUBISHI	015
NEXT LEVEL	047 048 064
PHILIPS	015 016 017 021 033 036 038 039 040 041 042 067
PRIMESTAR	046 049 050 063
PANASONIC	058 059 061 062
PAYSAT	016
PROSCAN	065 066
RCA	051 052 053 065 066
RADIOSHACK	064
REALISTIC	057
STAR TRAK	026
STS	020 027
SKY	031
SKY LIFE	005 006 007
SHACK	064
STAR CHOICE	064
SONY	054 060
TOSHIBA	015 017 028 029 030 072
ULTIMATE TV	060 066
UNIDEN	016 021 037 055 056 057
ZENITH	024 031 068

Setting up Your PC Software (Based on Windows XP)

The Windows display-settings for a typical computer are shown below. The actual screens on your PC may be different depending upon your particular version of Windows and your particular video card. Even if your actual screens look different, the same, basic set-up information will apply in almost all cases. (If not, contact your computer manufacturer or Samsung Dealer.)



1. First, click on "Control Panel" on the Windows start menu.
2. When the control panel window appears, click on "Appearance and Themes" and a display dialog-box will appear.
3. When the control panel window appears, click on "Display" and a display dialog-box will appear.
4. Navigate to the "Settings" tab on the display dialog-box.

The correct size setting (resolution): Optimum- 1920 X 1080

If a vertical-frequency option exists on your display settings dialog box, the correct value is "60" or "60 Hz". Otherwise, just click "OK" and exit the dialog box.

Display Modes

Both screen position and size will vary depending on the type of PC monitor and its resolution.

The resolutions in the table are recommended. (All resolutions between the supported limits are supported)

Mode	Resolution	Horizontal Frequency (kHz)	Vertical Frequency (Hz)	Pixel Clock Frequency (MHz)	Sync Polarity (H/V)
IBM	640 X 350	31.469	70.086	25.175	+ / -
	640 x 480	31.469	59.940	25.175	- / -
	720 x 400	31.469	70.087	28.322	- / +
VESA	640 X 480	35.000	70.000	28.560	- / +
	640 x 480	37.861	72.809	31.500	- / -
	640 x 480	37.500	75.000	31.500	- / -
	800 x 600	35.156	56.250	36.000	+ / +
	800 x 600	43.750	70.000	45.500	- / +
	800 x 600	37.879	60.317	40.000	+ / +
	800 x 600	48.077	72.188	50.000	+ / +
	800 x 600	46.875	75.000	49.500	+ / +
	1024 x 768	57.672	72.000	78.434	- / -
	1024 x 768	48.364	60.000	65.000	- / -
	1024 x 768	56.476	70.069	75.000	- / -
	1024 x 768	60.023	75.029	78.750	+ / +
	1152 x 864	67.500	75.000	108.000	+ / +
	1280 x 960	60.000	60.000	108.000	+ / +
	1280 x 1024	63.981	60.020	108.000	+ / +
	1280 x 1024	74.620	70.000	128.943	- / -
	1280 x 1024	76.824	72.000	132.752	- / -
1280 x 1024	79.976	75.025	135.000	+ / +	
1600 x 1200	75.000	60.000	162.000	+ / +	
1920 x 1080	66.587	59.934	138.500	+ / -	

- The interface mode is not supported.
- The set might operate abnormally if a non-standard video format is selected.
- HDMI/DVI does not support PC function.
- Separate and Composite modes are supported. SOG is not supported.

Setting the PC

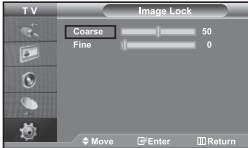
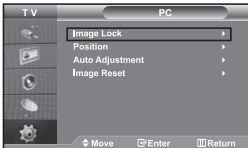

Press the **PC** button on the remote control to select the PC mode.

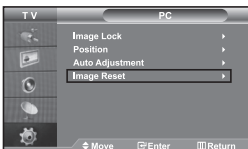
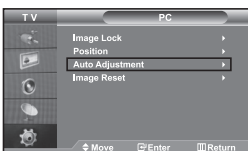
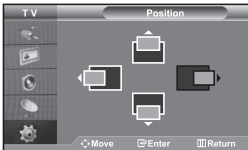
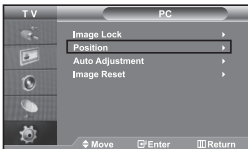

Coarse and Fine Tuning of the Image (Image Lock):

The purpose of picture quality adjustment is to remove or reduce picture noise. If the noise is not removed by Fine-tuning alone, then adjust the frequency as best as possible (coarse) and Fine-tune again. After the noise has been reduced, re-adjust the picture so that it is aligned on the center of screen.

1. Preset: Press the **PC** button to select PC mode.
2. Press the **MENU** button to display the menu. Press the **▲** or **▼** button to select "Setup", then press the **ENTER** button.
3. Press the **▲** or **▼** button to select "PC", then press the **ENTER** button.
4. Press the **ENTER** button to select "Image Lock".
5. Press the **▲** or **▼** button to select "Coarse" or "Fine", then press the **ENTER** button.
6. Press the **◀** or **▶** button to adjust the screen quality. Press the **ENTER** button.
7. Press the **EXIT** button to exit.

Changing the Image Position (Position):

Adjust the PC's screen positioning if it does not fit the TV screen.

1. Follow the "Coarse and Fine Tuning of the Image (Image Lock)" instructions number 1 to 3.
2. Press the **▲** or **▼** button to select "Position", then press the **ENTER** button.
3. Press the **▲** or **▼** button to adjusting the Vertical-Position. Press the **◀** or **▶** button to adjust the Horizontal-Position. Press the **ENTER** button.
4. Press the **EXIT** button to exit.

Adjusting the PC Screen Automatically (Auto Adjustment):

Auto adjustment allows the PC screen of set to self-adjust to the incoming PC video signal. The values of fine, coarse and position are adjusted automatically.

1. Follow the "Coarse and Fine Tuning of the Image (Image Lock)" instructions number 1 to 3.
2. Press the **▲** or **▼** button to select "Auto Adjustment", then press the **ENTER** button.
3. Press the **EXIT** button to exit.

Initializing the Image Settings (Image Reset):

You can replace all image settings with the factory default values.

1. Follow the "Coarse and Fine Tuning of the Image (Image Lock)" instructions number 1 to 3.
2. Press the **▲** or **▼** button to select "Image Reset", then press the **ENTER** button.
3. Press the **EXIT** button to exit.

Using the Anti-Theft Kensington Lock

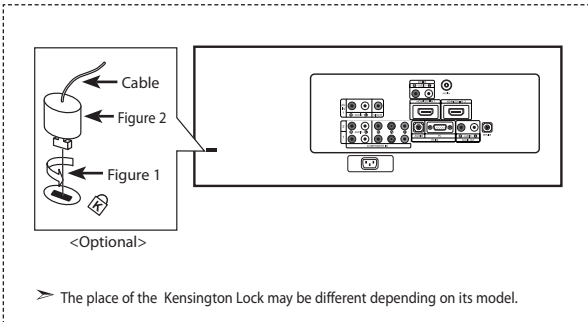

The Kensington lock is a device used to physically fix the system when using it in a public place.

The locking device has to be purchased separately. The appearance and locking method may differ from the illustration depending on the manufacturer. Please refer to the manual provided with the Kensington lock for proper use.



1. Insert the locking device into the Kensington slot on the LCD TV (Figure 1), and turn it in the locking direction (Figure 2).
2. Connect the Kensington lock cable.
3. Fix the Kensington lock to a desk or a heavy stationary object.

Troubleshooting: Before Contacting Service Personnel

No sound or picture	<ul style="list-style-type: none"> • Check that the mains lead has been connected to a wall socket. • Check that you have pressed the  buttons on the front of the set. • Check the picture contrast and brightness settings. • Check the volume.
Normal picture but no sound	<ul style="list-style-type: none"> • Check the volume. • Check whether the MUTE  button has been pressed on the remote control. • Check if "Internal Mute" is off
No picture or black and white picture	<ul style="list-style-type: none"> • Adjust the colour settings. • Check that the broadcast system selected is correct.
Sound and picture interference	<ul style="list-style-type: none"> • Try to identify the electrical appliance that is affecting the set and move it further away. • Plug your set into a different mains socket.
Blurred or snowy picture, distorted sound	<ul style="list-style-type: none"> • Check the direction, location and connections of your aerial. • This interference is often due to the use of an indoor aerial.
Remote control malfunctions	<ul style="list-style-type: none"> • Replace the remote control batteries. • Clean the upper edge of the remote control (transmission window). • Check the battery terminals.
"Check signal cable." message is displayed.	<ul style="list-style-type: none"> • Check that the signal cable is firmly connected to the PC or video sources. • Check that the PC or video sources are turned on.
On PC mode, "Mode Not Supported." message is displayed.	<ul style="list-style-type: none"> • Check the maximum resolution and the frequency of the video adaptor. • Compare these values with the data in the Display Modes.

The TFT LCD panel uses a panel consisting of sub pixels (3,147,264) which require sophisticated technology to produce. However, there may be few bright or dark pixels on the screen. These pixels will have no impact on the performance of the product.

Technical and Environmental Specifications

Model Name	LA40F7	LA46F7
Screen Size (Diagonal)	40 inch	46 inch
Power Supply	AC 100-240 V \pm 10%, 60/50 Hz	AC 100-240 V \pm 10%, 60/50 Hz
Power Consumption	210 W	275 W
PC Resolution	1920 x 1080 @ 60 Hz	1920 x 1080 @ 60 Hz
Sound Output	10 W x 2	10 W x 2
Dimension (WxDxH)		
Body	994 x 92 x 647 mm	1129 x 106 x 732 mm
With stand	994 x 326 x 696 mm	1129 x 326 x 788 mm
Weight		
With stand	24.5 kg	35.5 kg
Environmental Considerations		
Operating Temperature	10 °C to 40 °C (50 °F to 104 °F)	10 °C to 40 °C (50 °F to 104 °F)
Operating Humidity	10 % to 80 %, non-condensing	10 % to 80 %, non-condensing
Storage Temperature	-20 °C to 45 °C (-4 °F to 113 °F)	-20 °C to 45 °C (-4 °F to 113 °F)
Storage Humidity	5 % to 95 %, non-condensing	5 % to 95 %, non-condensing

Stand Swivel (Left / Right)

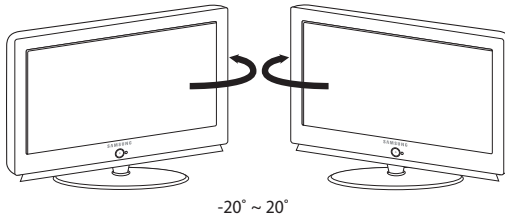

- Design and specifications are subject to change without prior notice.
- This device is a Class B digital apparatus.

***This page is intentionally
left blank.***