



LCD TV

LA32R81BD
LA40R81BD
LA40M81BD
LA46M81BD
LA52M81BD

Contact SAMSUNG WORLD-WIDE

If you have any questions or comments relating to Samsung products, please contact the SAMSUNG customer care centre.

Country	Customer Care Centre ☎	Web Site
AUSTRALIA	1300 362 603	www.samsung.com/au
CHINA	800-810-5858 , 010- 6475 1880	www.samsung.com.cn
HONG KONG	3698 - 4698	www.samsung.com/hk
INDIA	3030 8282 1800 1100 11	www.samsung.com/in
INDONESIA	0800-112-8888	www.samsung.com/id
JAPAN	0120-327-527	www.samsung.com/jp
MALAYSIA	1800-88-9999	www.samsung.com/my
PHILIPPINES	1800-10-SAMSUNG (7267864)	www.samsung.com/ph
SINGAPORE	1800-SAMSUNG (7267864)	www.samsung.com/sg
THAILAND	1800-29-3232 02-689-3232	www.samsung.com/th
TAIWAN	0800-329-999	www.samsung.com/tw
VIETNAM	1 800 588 889	www.samsung.vn
SOUTH AFRICA	0860 7267864 (SAMSUNG)	www.samsung.com/za
U.A.E	800SAMSUNG (7267864) 8000-4726	www.samsung.com/mea

Owner's Instructions

Before operating the unit, please read this manual thoroughly, and retain it for future reference.

ON-SCREEN MENUS
PC DISPLAY
PICTURE IN PICTURE (PIP)
TELETEXT

Register your product at www.samsung.com/global/register
Record your Model and Serial number here for future reference.
• Model _____ • Serial No. _____

Precautions When Displaying a Still Image

A still image may cause permanent damage to the TV screen.

- Do not display a still image on the LCD panel for more than 2 hours as it can cause screen image retention.

This image retention is also known as "screen burn".

To avoid such image retention, reduce the degree of brightness and contrast of the screen when displaying a still image.

-  Watching the LCD TV in 4:3 format for a long period of time may leave traces of borders displayed on the left, right and center of the screen caused by the difference of light emission on the screen.
Playing a DVD or a game console may cause a similar effect to the screen.
Damages caused by the above effect are not covered by the Warranty.

- Displaying still images from Video games and PC for longer than a certain period of time may produce partial after-images.
To prevent this effect, reduce the 'brightness' and 'contrast' when displaying still images.

Contents

CONNECTING AND PREPARING YOUR TV

◆ List of Parts	3
◆ Installing the Stand	3
◆ Installing the Wall Mount Kit	3
◆ Viewing the Control Panel	4
◆ Viewing the Connection Panel	5
◆ Viewing the Remote Control	8
◆ Installing Batteries in the Remote Control	9
◆ Switching On and Off	9
◆ Placing Your Television in Standby Mode	9
◆ Plug & Play	10

SETTING THE CHANNELS

◆ Storing Channels Automatically	11
◆ Storing Channels Manually	12
◆ Setting the Channel Manager	13
◆ Activating the Child Lock	13
◆ Sorting the Stored Channels	14
◆ Assigning Channels Names	14
◆ Fine Tuning Channel Reception	15
◆ LNA(Low Noise Amplifier)	15
◆ Changing the Picture Standard	16

SETTING THE PICTURE

◆ Adjusting the Custom Picture	16
◆ Changing the Colour Tone	17
◆ Configuring Detailed Settings on the Picture ..	18
◆ Activating Backlight	19
◆ Changing the Picture Size	19
◆ Freezing the Current Picture	20
◆ Digital NR / Active Colour / DNIe / Movie Plus	20
◆ Resetting the Picture Settings to the Factory Defaults	21
◆ Viewing the Picture In Picture (PIP)	21

SETTING THE SOUND

◆ Changing the Sound Standard	23
◆ Adjusting the Sound Settings	23
◆ Setting the TruSurround XT (SRS TS XT)	24
◆ Adjusting the Volume Automatically	24
◆ Selecting the Internal Mute	25
◆ Listening to the Sound of the Sub Picture	25
◆ Resetting the Sound Settings to the Factory Defaults	26
◆ Connecting Headphones	26
◆ Selecting the Sound Mode	26

SETTING THE TIME

◆ Setting and Displaying the Current Time	27
◆ Selecting the Sleep Timer	27
◆ Switching the Television On and Off Automatically	28

FUNCTION DESCRIPTION

◆ Using Game Mode	29
◆ Setting the Blue Screen Mode / Selecting the Melody	29
◆ Setting the Home Theatre PC	30
◆ Setting the Light Effect (LA32R81BD,LA40R81BD)	30
◆ Using the Energy Saving Feature	31
◆ HDMI Black Level	31

USING THE DTV FEATURE

◆ Previewing the DTV Menu System	32
◆ Updating the Channel List Automatically	33
◆ Updating the Channel List Manually	33
◆ Editing Your Favourite Channels	34
◆ Selecting Channel List	36
◆ Displaying Programme Information	36
◆ Viewing the EPG (Electronic Programme Guide) Information ...	37
◆ Using the Scheduled List	38
◆ Setting the Default Guide	38
◆ Viewing All Channels and Favourite Channels	39
◆ Selecting the Time Zone	39
◆ Adjusting the Menu Translucency	40
◆ Setting up the Parental Lock	40
◆ Setting the Subtitle	41
◆ Selecting the Audio Format	41
◆ Viewing Product Information	41
◆ Checking the Signal Information	42
◆ Upgrading the Software	42
◆ Resetting	44
◆ Selecting the Preferred Language (Subtitle , Audio)	44

USING THE TELETEXT FEATURE

- ◆ Selecting the Source 45
- ◆ Editing the Input Source Names 45
- ◆ Teletext Decoder 46
- ◆ Displaying the Teletext Information 46
- ◆ Selecting a Specific Teletext Page 47
- ◆ Using Fasttext to Select a Teletext Page 47
- ◆ Setting Up Your Remote Control 48
- ◆ Remote Control Codes 50

SETTING THE PC

- ◆ Setting up Your PC Software
(Based on Windows XP) 53
- ◆ Display Modes 53
- ◆ Setting the PC 55
- ◆ Wall-Mount Adjustment (LA40R81BD, LA40M81BD,
LA46M81BD, LA52M81BD) (Sold separately) ... 56

ABOUT ANYNET⁺

- ◆ What is Anynet+? 57
- ◆ Connecting Anynet⁺ Devices 57
- ◆ Setting Up Anynet⁺ 58
- ◆ Scanning and Switching between Anynet+
Devices 58
- ◆ Recording 59
- ◆ Listening through a Receiver 60
- ◆ Check Points before Requesting Service 60

RECOMMENDATIONS FOR USE

- ◆ Using the Anti-Theft Kensington Lock 61
- ◆ Troubleshooting:
Before Contacting Service Personnel 61
- ◆ Technical and Environmental Specifications .. 62

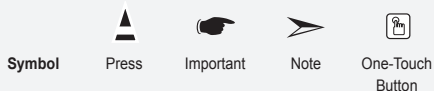

List of Parts

Please make sure the following items are included with your LCD TV.
If any items are missing, contact your dealer.

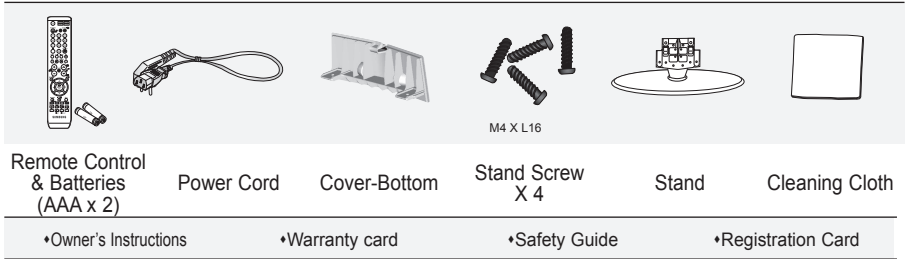

- Warranty card / Safety Guide / Registration Cards (Not available in all locations)
- The stand and stand screw may not be included depending on the model.

Installing the Stand

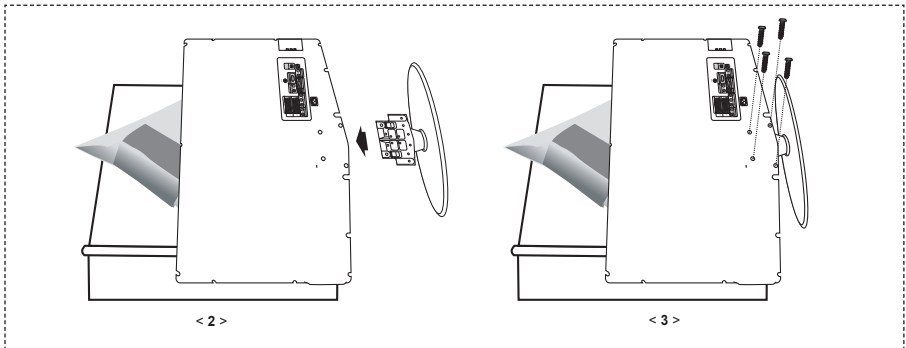

1. Place the TV faced down on a soft cloth or cushion on a table.
 2. Put the stand into the hole at the bottom of the TV.
 3. Insert screw into the hole indicated and tighten.
- The stand is installed for models with the screen size of 40 inch and above.

Installing the Wall Mount Kit

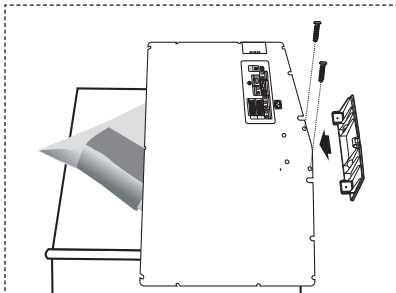

Wall mount items (sold separately) allow you to mount the TV on the wall.
For detailed information on installing the wall mount, see the instructions provided with the Wall Mount items. Contact a technician for assistance when installing the wall mounted bracket.
Samsung Electronics is not responsible for any damage to the product or injury to yourself or others if you elect to install the TV on your own.

- Remove the stand and cover the bottom hole with a cap and fasten with two screws.

Viewing the Control Panel

LA32R81BD, LA40R81BD

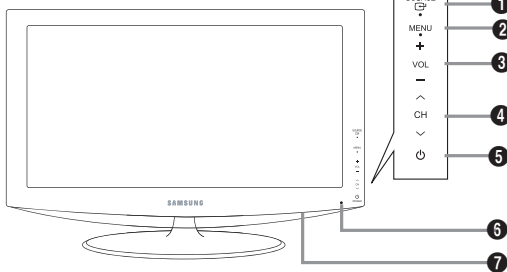

Front Panel buttons

Touch the right side of each button to operate.

LA40M81BD, LA46M81BD, LA52M81BD

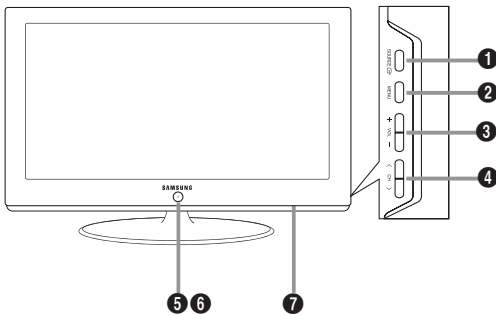

➤ The product colour and shape may vary depending on the model.

- 1 SOURCE**

Toggles between all the available input sources (TV, AV1, AV2, S-Video, Component1, Component2, PC, HDMI1, HDMI2, HDMI3, DTV). In the on-screen menu, use this button as you use the **ENTER/OK** button on the remote control.
- 2 MENU**

Press to see an on-screen menu of your TV's features.
- 3 + VOL -**

Press to increase or decrease the volume. In the on-screen menu, use the + VOL - buttons as you use the + and - buttons on the remote control.
- 4 ^ CH v**

Press to change channels. In the on-screen menu, use the ^ CH v buttons as you use the ^ and v buttons on the remote control. (Without the Remote Control, you can turn on the TV by using the Channel buttons.)
- 5 (Power)**

Press to turn the TV on and off. **Power Indicator** Blinks and turns off when the power is on and lights up in stand-by mode.
- 6 Remote Control Sensor**

Aim the remote control towards this spot on the TV.
- 7 Speakers**

Viewing the Connection Panel

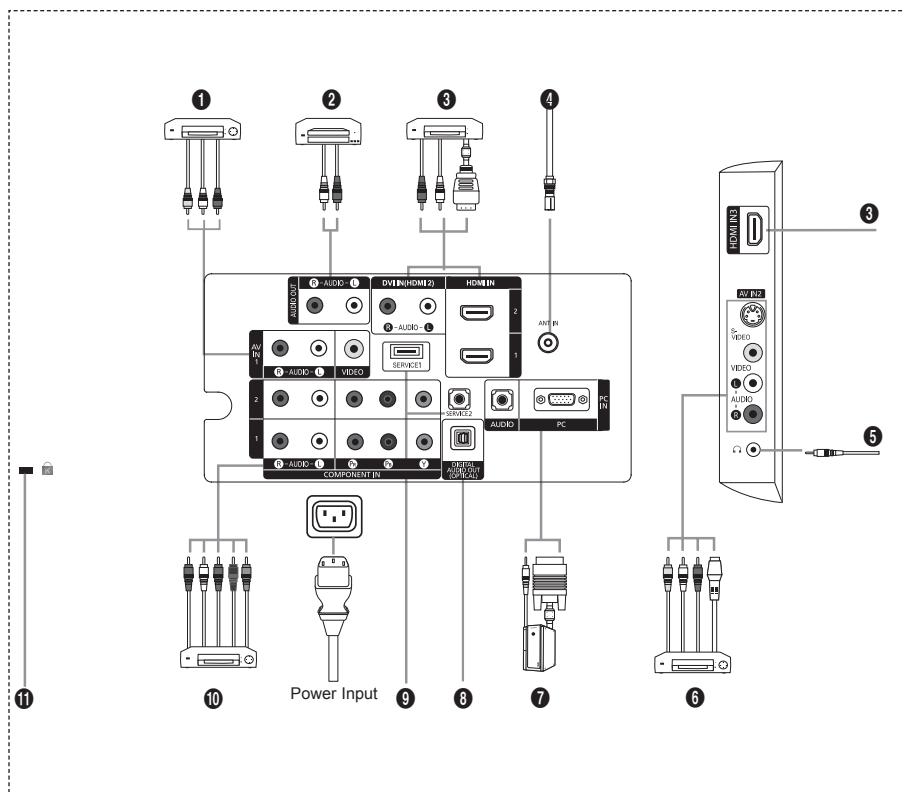

- > Whenever you connect an external device to your TV, make sure that power on the unit is turned off.
- > When connecting an external device, match the colour of the connection terminal to the cable.

1 Connecting External A/V Devices (AV IN 1)

- Connect RCA cable to an appropriate external A/V device such as VCR, DVD or Camcorder.
- Connect RCA audio cables to "R - AUDIO - L" on the rear of your set and the other ends to corresponding audio out connectors on the A/V device.

2 Connecting AUDIO

- Connect RCA audio cables to "R - AUDIO - L" on the rear of your set and the other ends to corresponding audio in connectors on the Amplifier or DVD Home Theater.

3 Connecting HDMI IN 1, HDMI IN 2, HDMI IN 3

- Supports connections between HDMI-connection-enabled AV devices (Set-Top Boxes, DVD players)
- No additional Audio connection is needed for an HDMI to HDMI connection.

> What is HDMI?

- "High Definition Multimedia interface" allows the transmission of high definition digital video data and multiple channels of digital audio (5. 1 channels).
- The HDMI/DVI terminal supports DVI connection to an extended device with the appropriate cable (not supplied). The difference between HDMI and DVI is that the HDMI device is smaller in size, has the HDCP (High Bandwidth Digital Copy Protection) coding feature installed, and supports multi - channel digital audio.

Connecting DVI IN(HDMI 2)(AUDIO R/L)

- When connecting this product via HDMI or DVI to a Set Top Box, DVD Player or Games Console etc, make sure that it has been set to a compatible video output mode as shown in the table below. Failure to observe this may result in picture distortion, image breakup or no picture.

- When using an HDMI/DVI cable connection, it is only possible from the HDMI 2 IN terminal.

> You should use the DVI-to-HDMI cable or DVI-HDMI Adapter for the connection, and the "R - AUDIO - L" terminal on DVI for sound output.

- > Supported modes for HDMI/DVI and Component

	480i	480p	576i	576p	720p	1080i	1080p
HDMI/DVI 50Hz	X	X	X	O	O	O	O
HDMI/DVI 60Hz	X	O	X	X	O	O	O
Component	O	O	O	O	O	O	O

- "1080p is for LA40M81BD, LA46M81BD, LA52M81BD only"

- Do not attempt to connect the HDMI/DVI connector to a PC or Laptop Graphics Card. (This will result in a blank screen being displayed)

4 Connecting an Aerial or Cable Television Network

To view television channels correctly, a signal must be received by the set from one of the following sources:

- An outdoor aerial / A cable television network / A satellite network

6 Connecting External A/V Devices

- Connect RCA or S-VIDEO cable to an appropriate external A/V device such as VCR, DVD or Camcorder.

- Connect RCA audio cables to "R - AUDIO - L" on the rear of your set and the other ends to corresponding audio out connectors on the A/V device.

- Headphone may be connected to the headphone output (5) on the rear of your set. While the head phone is connected, the sound from the built-in speakers will be disabled.

7 Connecting Computer

- Connect the D- Sub cable (optional) to "PC (PC IN)" on the rear of your set and the other end to the Video Card of your computer.

- Connect the stereo audio cable (optional) to "AUDIO (PC IN)" on the rear of your set and the other end to "Audio Out" of the sound card on your computer.

8 DIGITAL AUDIO OUT (OPTICAL)

- Connect to a Digital Audio Component.

9 SERVICE1, SERVICE2

- Service connection for qualified service engineer.

10 Connecting Component Devices (DVD)

- Connect component video cables (optional) to component connector ("P_R", "P_B", "Y") on the rear of your set and the other ends to corresponding component video out connectors on the DVD.
- If you wish to connect both the Set-Top Box and DVD, you should connect the Set-Top Box to the DVD and connect the DVD to component connector ("P_R", "P_B", "Y") on your set.
- The P_R, P_B and Y connectors on your component devices DVD are sometimes labeled Y, B-Y and R-Y or Y, Cb and Cr.
- Connect RCA audio cables (optional) to "R - AUDIO - L" on the rear of your set and the other ends to corresponding audio out connectors on the DVD.
- This LCD TV displays its optimum picture resolution in 720p mode.
- This LCD TV displays its maximum picture resolution in 1080i mode.

11 Kensington Lock

- The Kensington lock (optional) is a device used to physically fix the system when used in a public place.
- If you want to use a locking device, contact the dealer where you purchased the TV.
- The place of the Kensington Lock may be different depending on its model.

Viewing the Remote Control

- 1 Selects a target device to be controlled by the Samsung remote control (TV, DVD, STB, CABLE, VCR) (Refer to page 50-52)
- 2 Television Standby button
- 3 Number buttons for direct channel access
- 4 One/Two-digit channel selection
- 5 It display "Channel List" on the screen.
- 6 Selects the TV and DTV mode directly
- 7 VCR/DVD Functions Rewind, Stop, Play/Pause, Fast/Forward
- 8 \odot Volume increase
 \ominus Volume decrease
- 9 Temporary sound switch-off
- 10 Menu display and change confirmation
- 11 Returns to the previous menu
- 13 Electronic Program Guide (EPG) display
- 14 Picture size selection
- 15 Sound effect selection
- 16 Adjusts 5 separate devices - TV, DVD, STB, CABLE, or VCR.
- 17 When pressing this button, a number of buttons on the remote control (e.g. Selects a target device, volume, channel buttons) light up for a few seconds and then turn off to save power. This function is to conveniently use the remote control at night or when dark.
- 18 Available source selection
- 19 Previous channel
- 20 DTV menu display
- 21 Records for Live Broadcasting (Anynet+ function only, Refer to page 57)
- 22 P \odot : Next channel
P \ominus : Previous channel
- 23 Exit the OSD
- 24 Control the cursor in the menu
- 25 Use to see information on the current broadcast
- 26 Runs the Anynet view functions and sets up Anynet devices.
- 27 Colour buttons : Press to add or delete channels and to store channels to the favorite channel list in the "Channel List" menu.
- 28 Picture-In-Picture On / Off
- 29 Digital subtitle display
- 30 Picture effect selection
- 31 Picture freeze
- 32 When your remote does not work, change the batteries and press the "RESET" button for 2-3 seconds before use.

Teletext Functions

- 6 Exit from the teletext display
- 10 Teletext index
- 12 Alternately select Teletext, Double, or Mix.
- 14 Teletext size selection
- 18 Teletext mode selection (LIST/FLOF)
- 19 Teletext sub page
- 22 P \odot : Teletext next page
P \ominus : Teletext previous page
- 23 Teletext cancel
- 25 Teletext reveal
- 27 Fastext topic selection
- 28 Teletext hold
- 30 Teletext store

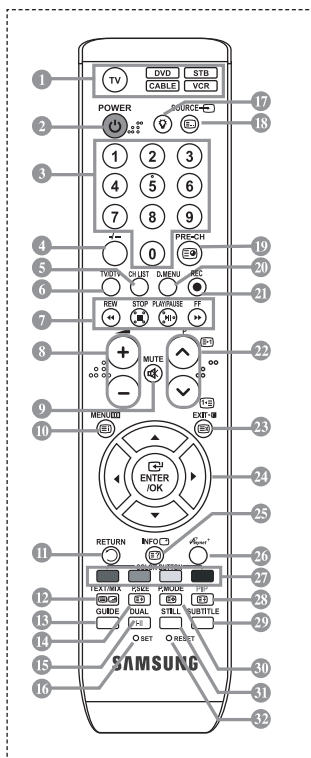

- > The performance of the remote control may be affected by bright light.
- > This is a special remote control for the visually impaired, and has Braille points on the Power, Channel, STOP, PLAY/PAUSE and Volume buttons.

Installing Batteries in the Remote Control

1. Lift the cover at the back of the remote control upward as shown in the figure.
2. Install two AAA size batteries.
 - > Make sure to match the "+" and "-" ends of the batteries with the diagram inside the compartment.
3. Replace the cover.
 - > Remove the batteries and store them in a cool, dry place if you won't be using the remote control for a long time. The remote control can be used up to about 23 feet from the TV.
 - (Assuming typical TV usage, the batteries last for about one year.)

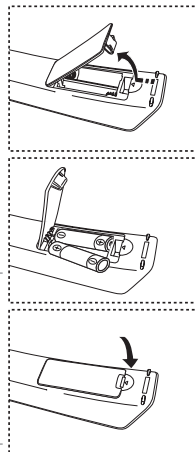

- > If the remote control doesn't work, check the following:
 1. Is the TV power on?
 2. Are the plus and minus ends of the batteries reversed?
 3. Are the batteries drained?
 4. Is there a power outage, or is the power cord unplugged?
 5. Is there a special fluorescent light or neon sign nearby?

Switching On and Off

The mains lead is attached to the rear of your set.

1. Plug the mains lead into an appropriate socket.
 - > The standby indicator lights up on the front of the set.
2. Press the ϕ button on the front of the set.
 - > You also can press the **POWER** ϕ button or the **TV/DTV** button on the remote control to turn the TV on.
 - > The programme that you were watching last is reselected automatically.
3. Press the numeric button (0-9) or channel up/down (\odot/\ominus) button on the remote control or \wedge CH \vee button on the right side of the set.
4. To switch your set off, press the **POWER** ϕ button again.

Placing Your Television in Standby Mode

Your set can be placed in standby mode in order to reduce the power consumption. The standby mode can be useful when you wish to interrupt viewing temporarily (during a meal, for example).

1. Press the **POWER** ϕ button on the remote control.
 - > The screen is turned off and a red standby indicator appears on the front of your set.
2. To switch your set back on, simply press the **POWER** ϕ , numeric buttons (0-9), **TV/DTV** button or channel up/down (\odot/\ominus) button again.
 - > Do not leave your set in standby mode for long periods of time (when you are away on holiday, for example).It is best to unplug the set from the mains and aerial.

Plug & Play

When the TV is initially powered on, several basic settings proceed automatically and subsequently. The following settings are available.



1. Press the **POWER** button on the remote control.
The message "Start Plug & Play" is displayed with "OK" selected.
Then press the **ENTER/OK** button.
2. The message "Select Home Mode When installing this TV at home" is displayed with "Shop" or "Home" selected
Press the ◀ or ▶ buttons to select "Shop" or "Home", then the **ENTER/OK** button.
 - > We recommend setting the TV to Home mode for the best picture in your home environment.
 - > Shop mode is only intended for use in retail environments.
 - > If the unit is accidentally set to Shop mode and you want to return to Dynamic (Home) mode, press the Volume button and then hold down the **MENU** button for five seconds on the side panel of the TV.
3. The message "Check antenna input." is displayed with "OK" selected.
Press the **ENTER/OK** button.
 - > Please check that the area cable is connected correctly.
4. The message "Some DTV functions may not be available.Digital Scan?" is displayed with "Yes" or "No" selected, Press the ◀ or ▶ buttons to select "Yes" or "No", then the **ENTER/OK** button.
5. The "Auto Store" menu is displayed with the "Start" selected. Press the **ENTER/OK** button.
 - > The channel search will start and end automatically.
 - After all the available channels are stored, the "Clock Set" menu appears.
 - > Press the **ENTER/OK** button at any time to interrupt the memorization process.
6. Press the **ENTER/OK** button.
Press the ◀ or ▶ buttons to move to the "Month", "Day", "Year", "Hour", "Minute",
Set the "Month", "Day", "Year", "Hour", "Minute" by pressing the ▲ or ▼ button.
 - > You can also set the hour and minute by pressing the number buttons on the remote control.When you have finished, press the **ENTER/OK** button
The message "Enjoy your viewing." is displayed.
7. Press the **ENTER/OK** button to confirm your setting.

- ♦ **Auto Store:** Automatically scans for and stores channels available in the local area.
- ♦ **Clock Set:** Sets the current time for the TV clock.

If you want to reset this feature...

1. Press the **MENU** button to display the menu.
Press the **▲** or **▼** button to select "Setup", then press the **ENTER/OK** button.
2. Press the **ENTER/OK** button again, to select "Plug & Play".
3. The message to "Start Plug & Play" is displayed.

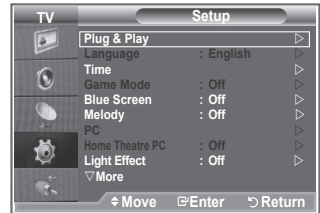

- Storing Channels Automatically
- Storing Channels Manually



Storing Channels Automatically

You can scan for the frequency ranges available to you (and availability depends on your country). Automatically allocated programme numbers may not correspond to actual or desired programme numbers. However, you can sort numbers manually and clear any channels you do not wish to watch.

1. Press the **MENU** button to display the menu.
Press the **▲** or **▼** button to select "Channel", then press the **ENTER/OK** button.
2. Press the **▲** or **▼** button to select "Auto Store" then press the **ENTER/OK** button.
3. Press the **ENTER/OK** button.
 - > The TV will begin memorizing all of the available channels.
 - > Press the **ENTER/OK** button at any time to interrupt the memorization process and return to the "Channel" menu.
4. After all the available channels are stored, the "Sort" menu appears.

Storing Channels Manually

You can store up to 100 channels, including those received via cable networks.

When storing channels manually, you can choose:

◆ Whether or not to store each of the channels found.

◆ The programme number of each stored channel which you wish to identify.

1. Press the **MENU** button to display the menu.
Press the **▲** or **▼** button to select "Channel", then press the **ENTER/OK** button.
2. Press the **▲** or **▼** button to select "Manual Store", then press the **ENTER/OK** button.
3. Press the **ENTER/OK** button to select "Programme".
4. To assign a programme number to a channel, find the correct number by pressing the **▲** or **▼** button and then press the **ENTER/OK** button.
➤ You can also set a programme number by pressing number buttons on the remote control.
5. Press the **▲** or **▼** button to select "Colour System", then press the **ENTER/OK** button.
6. Select the colour standard required by pressing the **▲** or **▼** button then, press the **ENTER/OK** button.
7. Press the **▲** or **▼** button to select "Sound System", then press the **ENTER/OK** button.
8. Select the sound standard required by pressing the **▲** or **▼** button, then press the **ENTER/OK** button.
➤ If there is an abnormal sound or no sound, re-select the sound system required.
9. If you know the number of the channel to be stored, press the **▲** or **▼** button to select "Channel". Press the **ENTER/OK** button. Select **C** (Air channel) or **S** (Cable channel) by pressing the **▲** or **▼** button. Press the **▶** button to select channel.
Select the required number by pressing the **▲** or **▼** button and then press the **ENTER/OK** button.
➤ Channel mode: **P** (Programme mode), **C** (Air channel mode), **S** (Cable channel mode)
➤ You can also set a channel number by pressing number buttons on the remote control.
10. If you do not know the channel numbers, press the **▲** or **▼** button to select "Search". Press the **ENTER/OK** button. Search by pressing the **▲** or **▼** button and then press the **ENTER/OK** button.
11. Press the **▲** or **▼** button to select "Store". Press the **ENTER/OK** button to select "OK".
12. Repeat steps 3 to 11 for each channel to be stored.

- ◆ **Programme:** Selects a program number for the channel.
- ◆ **Colour System:** Sets the colour supporting system.
- ◆ **Sound System:** Sets the sound supporting system.
- ◆ **Channel:** Selects a channel.
- ◆ **Search:** Scans for the frequency value for the channel.
- ◆ **Store:** Saves your settings.

Setting the Channel Manager

Set the channels according to your preference.
You can easily delete, add, or lock the channel you want.

1. Press the **MENU** button to display the menu.
Press the **▲** or **▼** button to select "Channel", then press the **ENTER/OK** button.
 2. Press the **▲** or **▼** button to select "Channel Manager", then press the **ENTER/OK** button.
 3. Press the **ENTER/OK** button again, to select "Channel List".
 4. Press the **▶** button to select " " line.
 5. Press the **▲** or **▼** button to select the undesired channel, then press the **ENTER/OK** button to cancel.
 6. Repeat steps 5 for each channel to be selected or canceled
 7. Press the **EXIT** button to exit.
- " " is active when "Child Lock" is selected to "On".

-  You can select these options by simply pressing the **CH LIST** button on the remote control.
Then you can press the **EXIT** button to exit.

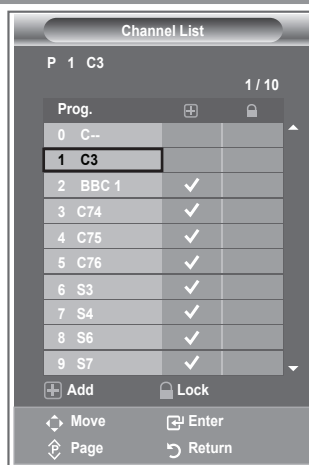

Activating the Child Lock

This feature allows you to prevent unauthorized users, such as children, from watching unsuitable programmes by muting out video and audio. Child Lock cannot be released using the buttons on the side. Only the remote control can release the Child Lock setting, so keep the remote control away from children.

1. Press the **MENU** button to display the menu.
Press the **▲** or **▼** button to select "Channel", then press the **ENTER/OK** button.
 2. Press the **▲** or **▼** button to select "Channel Manager", then press the **ENTER/OK** button.
 3. Press the **▲** or **▼** button to select "Child Lock", then press the **ENTER/OK** button.
 4. Press the **▲** or **▼** button to select "On" or "Off". Press the **ENTER/OK** button.
 5. Press the **▲** or **▼** button to select "Channel List", then press the **ENTER/OK** button.
 6. Press the **▶** button to select " " line.
 7. Press the **▲** or **▼** button to select the channels you want to lock, then press the **ENTER/OK** button.
 8. Repeat steps 7 for each channel to be locked or unlocked.
 9. Press the **EXIT** button to exit.
- Select "On" or "Off" in "Child Lock" to easily turn the channels which selected on " " to be active or inactive.



Sorting the Stored Channels

You can exchange the numbers of two channels, in order to:

- ◆ **Modify the numeric order in which the channels have been automatically stored.**
 - ◆ **Give easily remembered numbers to the channels that you watch most often.**
1. Press the **MENU** button to display the menu. Press the **▲** or **▼** button to select "Channel", then press the **ENTER/OK** button.
 2. Press the **▲** or **▼** button to select "Sort", then press the **ENTER/OK** button.
 3. Select the channel number that you wish to change by pressing the **▲** or **▼** button repeatedly. Press the **ENTER/OK** button.
 - The selected channel number and name are moved to right side.
 4. Press the **▲** or **▼** button to move to the position in which you would like to change and then press the **ENTER/OK** button.
 - The selected channel is exchanged with the one previously stored to the chosen number.
 5. Repeat steps **3** to **4** for another channel to be sorted.
 6. Press the **EXIT** button to exit.

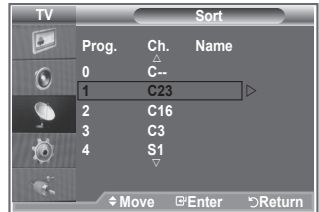

Assigning Channels Names

Channel names will be assigned automatically when channel information is broadcast. These names can be changed, allowing you to assign new names.

1. Press the **MENU** button to display the menu. Press the **▲** or **▼** button to select "Channel", then press the **ENTER/OK** button.
2. Press the **▲** or **▼** button to select "Name", then press the **ENTER/OK** button.
3. If necessary, select the channel to be assigned to a new name by pressing the **▲** or **▼** button. Press the **ENTER/OK** button.
 - The selection bar is displayed around the name box.
4.

To...	Then...
Select a letter, number or symbol	Press the ▲ or ▼ button
Move on the next letter	Press the ▶ button
Move back the previous letter	Press the ◀ button
Confirm the name	Press the ENTER/OK button

 - The characters available are : Letters of the alphabet (A~Z) / Numbers (0~9) / Special characters (-, space, / , * , +)
5. Repeat steps **3** to **4** for each channel to be assigned to a new name.
6. Press the **EXIT** button to exit.

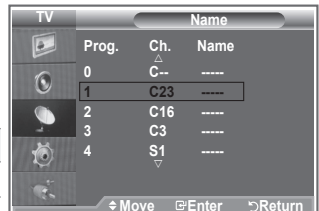

Fine Tuning Channel Reception

Use fine tuning to manually adjust a particular channel for optimal reception.

1. Use the number buttons to directly select the channel that you want to fine tune.
2. Press the **MENU** button to display the menu. Press the **▲** or **▼** button to select "Channel", then press the **ENTER/OK** button.
3. Press the **▲** or **▼** button to select "Fine Tune", then press the **ENTER/OK** button.
4. Press the **◀** or **▶** button to adjust the fine tuning. Press the **ENTER/OK** button.
5. Press the **EXIT** button to exit.
 - Fine tuned channels that have been saved are marked with an asterisk "*" on the right-hand side of the channel number in the channel banner. And the channel number turns red.
 - To reset the fine-tuning, select "Reset" by pressing the **▲** or **▼** button and then press the **ENTER/OK** button.



LNA (Low Noise Amplifier)

If the TV is operating in a weak-signal area, sometimes the LNA function can improve the reception (a low-noise preamplifier boosts the incoming signal).

1. Press the **MENU** button to display the menu. Press the **▲** or **▼** buttons to select "Channel", then press the **ENTER/OK** button.
2. Press the **▲** or **▼** buttons to select "LNA", then press the **ENTER/OK** button.
3. Press the **▲** or **▼** buttons to select "On", or "Off". Press the **ENTER/OK** button.
4. Press the **EXIT** button to exit.



Changing the Picture Standard

You can select the type of picture which best corresponds to your viewing requirements.

1. Press the **MENU** button to display the menu. Press the **ENTER/OK** button to select "Picture".
2. Press the **ENTER/OK** button again, to select "Mode".
3. Press the **▲** or **▼** button to select the desired picture effect. Press the **ENTER/OK** button.
4. Press the **EXIT** button to exit.

- ♦ **Dynamic:** Selects the picture for high-definition in a bright room.
- ♦ **Standard:** Selects the picture for optimum display in a normal environment.
- ♦ **Movie:** Selects the picture for comfortable display in a dark room.

- The Picture mode must be adjusted separately for each input source.
- You can return to the factory defaults picture settings by selecting the "Reset". (Refer to "Resetting the Picture Settings to the Factory Defaults" on page 21)

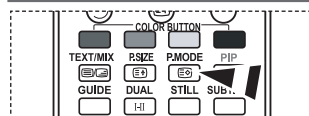
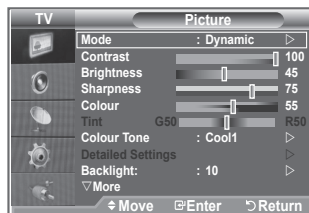

You can also press the **P.MODE** button on the remote control to select one of the picture settings.

Adjusting the Custom Picture

Your set has several settings which allow you to control picture quality.

1. To select the desired picture effect, follow the "Changing the Picture Standard" instructions number 1 to 3. on page 16
2. Press the **▲** or **▼** button to select a particular item. Press the **ENTER/OK** button.
3. Press the **◀** or **▶** button to decrease or increase the value of a particular item. Press the **ENTER/OK** button.
4. Press the **EXIT** button to exit.

- ♦ **Contrast:** Adjusts the lightness and darkness between objects and the background.
- ♦ **Brightness:** Adjusts the brightness of the whole screen.
- ♦ **Sharpness:** Adjusts the outline of objects to either sharpen them or make them more dull.
- ♦ **Colour:** Adjusts the colours, making them lighter or darker.
- ♦ **Tint(NTSC or DTV):** Adjusts the colour of objects, making them more red or green for a more natural look.

- The adjusted values are stored according to the selected Picture mode.
- In PC Mode, Only "Contrast", "Brightness" can be adjusted.

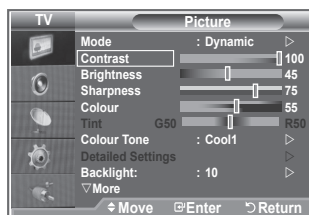

Changing the Colour Tone

You can select the most comfortable colour tone to your eyes.

1. To select the desired picture effect, follow the "Changing the Picture Standard" instructions number 1 to 3. on page 16
2. Press the **▲** or **▼** button to select "Colour Tone", then press the **ENTER/OK** button.
3. Press the **▲** or **▼** button to select the desired colour tone setting. Press the **ENTER/OK** button.
4. Press the **EXIT** button to exit

- ♦ **Cool2:** Makes the colour temperature bluer than "Cool1" menu.
- ♦ **Cool1:** Makes whites bluish.
- ♦ **Normal:** Keeps whites white.
- ♦ **Warm1:** Makes whites reddish.
- ♦ **Warm2:** Makes the colour temperature redder than "Warm1" menu.

- The adjusted values are stored according to the selected Picture mode.
- When the picture mode is set to Dynamic or Standard, Warm1 and Warm2 cannot be selected.

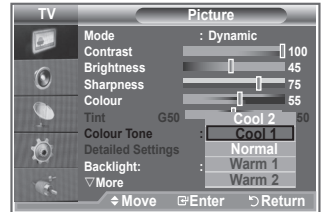
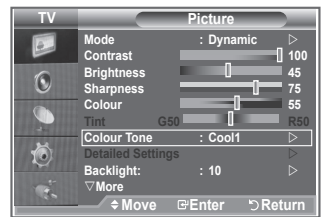

Configuring Detailed Settings on the Picture

You can set detailed picture settings.

- 1 Press the **MENU** button to display the menu.
- 2 Press the **ENTER/OK** button, to select "Picture".
- 3 Press the **▲** or **▼** button to select Detailed Settings, then press the **ENTER/OK** button.
- 4 Select the required option by pressing the **▲** or **▼** button, then press the **ENTER/OK** button.

Available options: Black Adjust, Dynamic Contrast, Gamma, White Balance, My Colour Control, Edge Enhancement, Colour Space.

- 5 When you are satisfied with your setting, press the **ENTER/OK** button.
- 6 Press the **EXIT** button to exit.
 - When the picture mode is set to Movie, Detailed Settings can be selected.
 - If DNIe is Off, the Detailed Settings cannot be selected when the Picture mode is in Standard mode.

◆ **Black Adjust: Off/Low/Medium/High**

You can directly select the black level on the screen to adjust the screen depth.

◆ **Dynamic Contrast: Off/Low/Medium/High**

You can adjust the screen contrast so that the optimal contrast is provided.

◆ **Gamma: -3 ~ 3**

You can adjust the middle brightness of pictures.
Press the **◀** or **▶** button until you reach the optimal setting.

◆ **White Balance: R-Offset/G-Offset/B-Offset/R-Gain/G-Gain/B-Gain/Reset**

You can adjust the color temperature for more natural picture colors.

R-Offset/G-Offset/B-Offset/R-Gain/G-Gain/B-Gain: Changing the adjustment value will refresh the adjusted screen.

Select the required option by pressing the **▲** or **▼** button, then press the **ENTER/OK** button.

Press the **◀** or **▶** button until you reach the optimal setting.

Reset: The previously adjusted white balance will be reset to the factory defaults.

◆ **My Colour Control: Pink/Green/Blue/White/Reset**

This setting can be adjusted to suit your personal preferences.

When running the My Colour Control feature, the current picture is captured as a still image before being displayed on the screen.

◆ **Edge Enhancement: On/Off**

You can emphasize object boundaries.

◆ **Colour Space: Auto/Wide**

You can set the color reproduction space for the input signal to Auto or Wide.

◆ **xvYCC: Off/On(LA40M81BD/LA46M81BD/LA52M81BD)**

Setting the xvYCC mode to On increases detail and color space when watching movies from an external device (ie. DVD player) connected to the HDMI or Component IN jacks. You must set the Picture Mode to Movie to enjoy this feature. When you set the xvYCC mode to On the PIP will Off automatically.

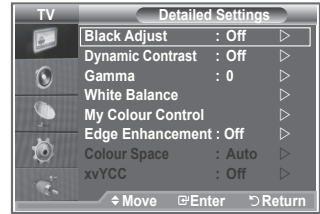
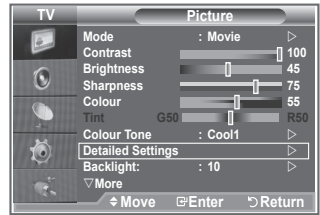

Activating Backlight

You can adjust the screen brightness by adjusting the LCD backlight brightness. (0~10)

1. Press the **MENU** button to display the menu.
Press the **ENTER/OK** button, to select "Picture".
2. Press the **▲** or **▼** button to select "Backlight", then press the **ENTER/OK** button.
3. Press the **◀** or **▶** button to decrease or increase the value of a particular item.
Press the **ENTER/OK** button.
Press the **EXIT** button to exit.

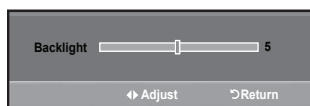
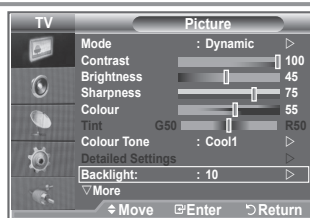



Changing the Picture Size

You can select the picture size which best corresponds to your viewing requirements.

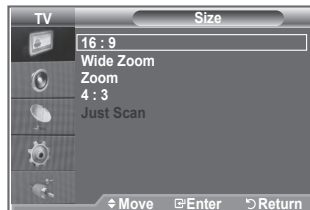
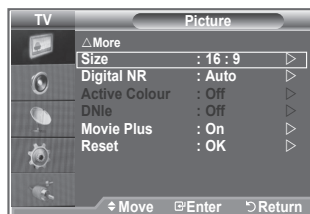
1. Press the **MENU** button to display the menu.
Press the **ENTER/OK** button, to select "Picture".
2. Press the **▲** or **▼** button to select "Size", then press the **ENTER/OK** button.
3. Select the required option by pressing the **▲** or **▼** button.
Press the **ENTER/OK** button.
4. Press the **EXIT** button to exit.



- **16:9**: Adjusts the picture size to 16:9 appropriate for DVDs or wide broadcasting.
- **Wide Zoom**: Magnifies the size of the picture more than 4:3.
- **Zoom**: Magnifies the 16:9 wide picture (in the vertical direction) to fit the screen size.
- **4:3**: This is the default setting for a video movie or normal broadcasting.
- **Just Scan**: Displays the input scenes as they are without any cutoff when 720p 1080i(LA32R8 LA40R8)and1080p,1080i, 720p(LA40M81BD LA46M81BD LA52M81BD) signals are input.

- > "Wide Zoom" function is available only in "TV", "AV1", "AV2", and "S-Video", "component1", "component2", "HDMI" mode.
- > In PC Mode, only "16:9" and "4:3" mode can be adjusted.
- > Just Scan Mode is available only HDMI mode
- > Zoom: Select  by pressing the **◀** or **▶** buttons.
Use the **▲** or **▼** button to move the picture up and down. After selecting , use the **▲** or **▼** button to magnify or reduce the picture size in the vertical direction.
- > Wide Zoom: Move the screen up/down using the **▲** or **▼** buttons after selecting the  by pressing the **▶** or **ENTER/OK** button.

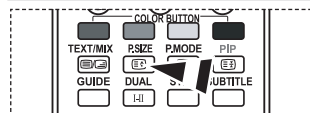

-  You can select these options by simply pressing the **P.SIZE** button on the remote control.

Freezing the Current Picture

Press the **STILL** button to freeze a moving picture into a still one. Press again to cancel.

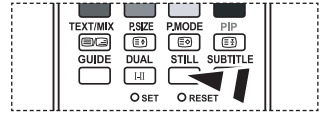

Digital NR / Active Colour / DNle / Movie Plus

If the broadcast signal received by your TV is weak, you can activate the Digital Noise Reduction feature to help reduce any static and ghosting that may appear on the screen.

1. Press the **MENU** button to display the menu. Press the **ENTER/OK** button, to select "Picture".
2. Select the required option by pressing the **▲** or **▼** button, then press the **ENTER/OK** button. Available options: Digital NR, Active Colour, DNle, Movie Plus.
3. When you are satisfied with your setting, press the **ENTER/OK** button.
4. Press the **EXIT** button to exit.

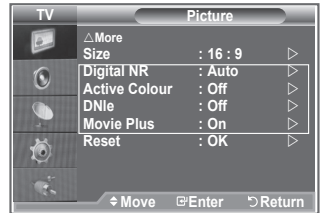

◆ **Digital NR: Off/Low/Medium/High/Auto**

If the signal received by the television is weak, you can activate this feature to reduce any static and ghosting that may appear on the screen.

◆ **Active Colour: Off/On**

If you turn on this option, the colors of the sky and grass will be stronger and clearer for a more vivid on-screen picture.

- This function is not available in PC mode.
- This function is available in Dynamic mode

◆ **DNle : Off/Demo/On**

This TV includes the DNle function so as to provide a high visual quality. If you set DNle to on, you can view the screen with the DNle feature activated. If you set the DNle to Demo, you can view the applied DNle and normal pictures on the screen, for demonstration purposes. Using this function, you can view the difference in the visual quality.

- DNle™ (Digital Natural Image engine) **DNle™** This feature brings you more detailed image with 3D noise reduction, detail enhancement, contrast enhancement and white enhancement. New image compensation Algorithm gives brighter, clearer, more detailed image to you. DNle™ technology will fit every signal into your eyes.
- This function is not available in PC mode.
- This function is not available in Movie mode

◆ **Movie Plus: Off/On**

You can view more natural skin and clear text even in fast moving scenes.

- Use this function when watching movies.

Resetting the Picture Settings to the Factory Defaults

You can return to the factory defaults picture settings.

1. To select the desired picture effect, follow the "Changing the Picture Standard" instructions number 1 to 3 on page 16.
2. Press the ▲ or ▼ button to select "Reset", then press the **ENTER/OK** button.
3. Press the ▲ or ▼ button to select "OK", "Cancel", then press the **ENTER/OK** button.
4. Press the **EXIT** button to exit.
 - > The "Reset" will be set for each picture mode.

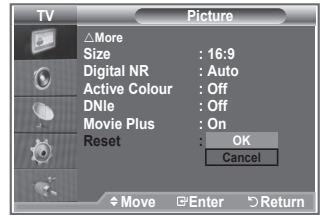

Viewing the Picture In Picture (PIP)

You can display a sub picture within the main picture of set programme or video input. In this way, you can watch the picture of set programme or video input from any connected equipment while watching the main picture.

1. Press the **MENU** button to display the menu. Press the **ENTER/OK** button, to select "Setup".
2. Press the ▲ or ▼ button to select "PIP", then press the **ENTER/OK** button.
3. Press the **ENTER/OK** button again. Press the ▲ or ▼ button to select "On", then press **ENTER/OK** button.
4. Press the ▲ or ▼ button to select "Source", then press **ENTER/OK** button. Select a source of the sub picture by pressing the ▲ or ▼ button and press the **ENTER/OK** button.
 - > The sub picture can serve different source selections based on what the main picture is set to.
5. Press the ▲ or ▼ button to select "Size" of the sub picture and then press the **ENTER/OK** button. Select a size of the sub picture by pressing the ▲ or ▼ button and then press the **ENTER/OK** button.
 - > If main picture is in "HDMI" mode, "Size" is available.

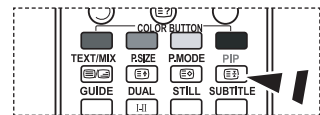
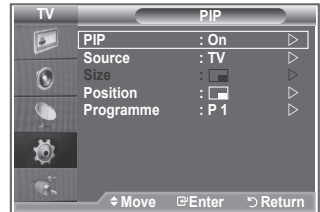
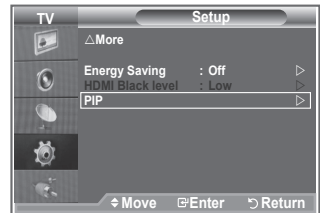

Press the **PIP** button on the remote control repeatedly to activate or deactivate the "PIP".

6. Press the ▲ or ▼ button to select "Position", then press the **ENTER/OK** button.
Select the position of the sub picture by pressing the ▲ or ▼ button and then press the **ENTER/OK** button.
7. Press the ▲ or ▼ button to select "Programme" and then press the **ENTER/OK** button.
You can select the channel that you want to view through sub picture by pressing the ▲ or ▼ button. Press the **ENTER/OK** button.
➢ The "Programme" can be active when the sub picture is set to TV.
8. Press the **EXIT** button to exit.
➢ You may notice that the picture in the PIP window becomes slightly unnatural when you use the main screen to view a game or karaoke.

- ♦ **Source:** Used to select a source of the sub picture.
- ♦ **Size:** Used to select a size of the sub picture.
- ♦ **Position:** Used to move the sub picture.
- ♦ **Programme:** Used to Change the sub picture.

PIP Settings

O: PIP operates, **X:** PIP doesn't operate

Main \ Sub	TV	AV1	AV2	S-Video	Component1,2	PC	HDMI1,2,3
Component1,2	O	O	O	X	X	X	X
PC	O	O	O	X	X	X	X
HDMI1,2,3	O	O	O	X	X	X	X

Changing the Sound Standard

You can select the type of the special sound effect to be used when watching a given broadcast.

1. Press the **MENU** button to display the menu.
Press the **▲** or **▼** button to select "Sound", then press the **ENTER/OK** button.
2. Press the **ENTER/OK** button again, to select "Mode".
3. Select the required sound effect by pressing the **▲** or **▼** button repeatedly and then press the **ENTER/OK** button.
4. Press the **EXIT** button to exit.

- ♦ **Standard:** Selects the normal sound mode.
- ♦ **Music:** Emphasizes music over voices.
- ♦ **Movie:** Provides live and full sound for movies.
- ♦ **Speech:** Emphasizes voices over other sounds.
- ♦ **Custom:** Selects your custom sound settings.
(Refer to "Adjusting the Sound Settings")

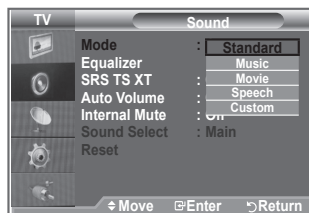
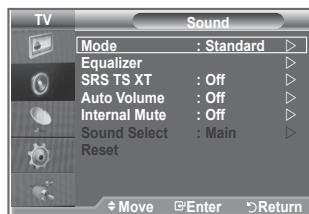

Adjusting the Sound Settings

The sound settings can be adjusted to suit your personal preferences.

1. Press the **MENU** button to display the menu.
Press the **▲** or **▼** button to select "Sound", then press the **ENTER/OK** button.
2. Press the **▲** or **▼** button to select "Equalizer", then press the **ENTER/OK** button.
3. Press the **◀** or **▶** button to select a particular item.
Press the **ENTER/OK** button.
4. Press the **▲** or **▼** button to reach the required setting.
Press the **ENTER/OK** button.
5. Press the **EXIT** button to exit.
 - If you make any changes to these settings, the Sound Mode is automatically switched to "Custom".

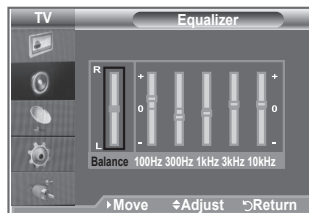
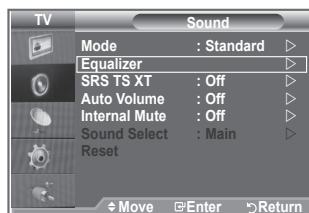

Setting the TruSurround XT (SRS TS XT)

TruSurround XT is a patented SRS technology that solves the problem of playing 5.1 multichannel content over two speakers. TruSurround delivers a compelling, virtual surround sound experience through any two-speaker playback system, including internal television speakers. It is fully compatible with all multichannel formats.

1. Press the **MENU** button to display the menu.
Press the **▲** or **▼** button to select "Sound", then press the **ENTER/OK** button.
2. Press the **▲** or **▼** button to select "SRS TS XT", then press the **ENTER/OK** button.
3. Press the **▲** or **▼** button to select "On" or "Off". Press the **ENTER/OK** button.
4. Press the **EXIT** button to exit.

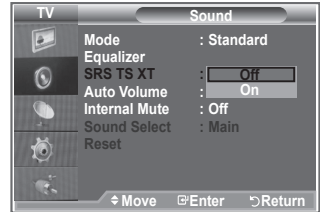
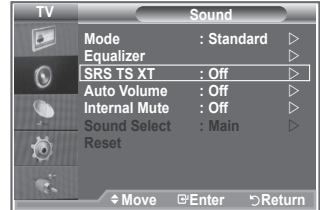

Adjusting the Volume Automatically

Each broadcasting station has its own signal conditions, and so it is not easy for you to adjust the volume every time the channel is changed. This feature allows you to automatically adjust the volume of the desired channel by lowering the sound output when the modulation signal is high or by raising the sound output when the modulation signal is low.

1. Press the **MENU** button to display the menu.
Press the **▲** or **▼** button to select "Sound", then press the **ENTER/OK** button.
2. Press the **▲** or **▼** button to select "Auto Volume", then press the **ENTER/OK** button.
3. Press the **▲** or **▼** button to select "On" or "Off". Press the **ENTER/OK** button.
4. Press the **EXIT** button to exit.

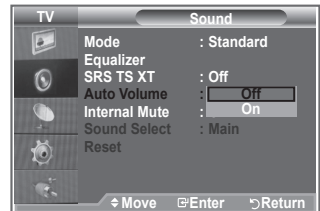
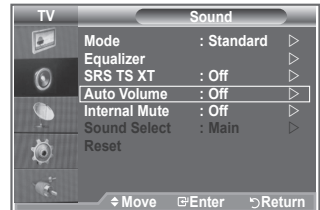

Selecting the Internal Mute

If you want to hear the sound through separate speakers, cancel the internal amplifier.

1. Press the **MENU** button to display the menu.
Press the **▲** or **▼** button to select "Sound", then press the **ENTER/OK** button.
2. Press the **▲** or **▼** button to select "Internal Mute", then press the **ENTER/OK** button.
3. Press the **▲** or **▼** button to select "On" or "Off". Press the **ENTER/OK** button.
4. Press the **EXIT** button to exit.
 - > When "Internal Mute" is set to "On", the Sound menus except for "Sound Select" (in PIP mode) cannot be adjusted.

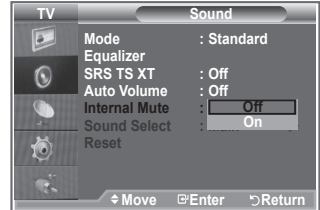
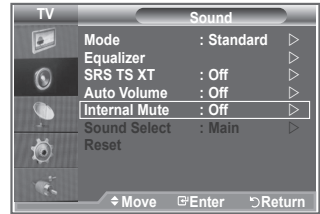

Listening to the Sound of the Sub Picture

During the PIP features activation, you can listen to the sound of the sub picture.

1. Press the **MENU** button to display the menu.
Press the **▲** or **▼** button to select "Sound", then press the **ENTER/OK** button.
2. Press the **▲** or **▼** button to select "Sound Select", then press the **ENTER/OK** button.
3. Press the **▲** or **▼** button to select "Main".
Press the **ENTER/OK** button.
4. Press the **EXIT** button to exit.

- **Main** : Used to listen to the sound of the main picture.
- **Sub** : Used to listen to the sound of the sub picture.

> You can select this option when the "PIP" is set to "On".

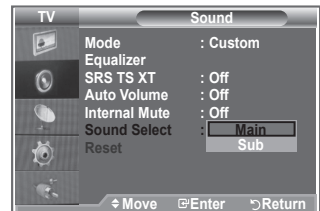
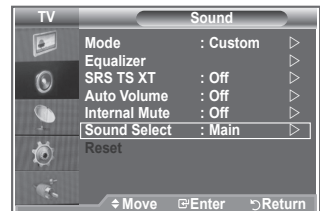

Resetting the Sound Settings to the Factory Defaults

If Game Mode is On, the Reset Sound function is activated. Selecting the Reset function after setting the equalizer resets the equalizer setting to the factory defaults.

1. Press the **MENU** button to display the menu. Press the **▲** or **▼** button to select "Sound", then press the **ENTER/OK** button.
2. Press the **▲** or **▼** button to select "Reset", then press the **ENTER/OK** button.
3. Press the **EXIT** button to exit.
 - > You can select this option when the "Game Mode" is set to "On".

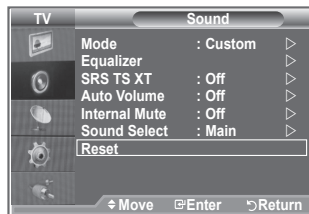

Connecting Headphones

You can connect a set of headphones to your set if you wish to watch a TV programme without disturbing the other people in the room.

- > When you insert the head set jack into the corresponding port, you can operate only Auto Volume "SRS TS XT" and Sound Select (in PIP mode) in Sound menu.
- > Prolonged use of headphones at a high volume may damage your hearing.
- > You will not receive sound from the speakers when you connect headphones to the system.
- > The headphone volume and TV volume are adjusted differently.



Selecting the Sound Mode

You can set the sound mode by pressing the "DUAL" button. When you press it, the current sound mode is displayed on the screen.

	Audio Type	DUAL 1/2	Default
FM Stereo	Mono	MONO	Automatic change
	Stereo	STEREO ↔ MONO	
	Dual	DUAL 1 ↔ DUAL 2	DUAL 1
NICAM Stereo	Mono	MONO	Automatic change
	Stereo	MONO ↔ STEREO	
	Dual	MONO ↔ DUAL 1 DUAL 2 ↔	DUAL 1

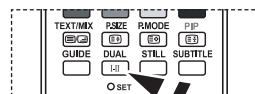

- > You can also set these options simply by pressing the **DUAL** button on remote control.

- > If the stereo signal is weak and an automatic switching occurs, then switch to the Mono.

Setting and Displaying the Current Time

You can set the TV's clock so that the current time is displayed when you press the INFO button. You must also set the time if you wish to use the automatic On/Off timers.

1. Press the **MENU** button to display the menu.
Press the **▲** or **▼** button to select "Setup", then press the **ENTER/OK** button.
2. Press the **▲** or **▼** button to select "Time", then press the **ENTER/OK** button.
3. Press the **ENTER/OK** button to select "Clock Set".

To...	Press the...
Move to "Year", "Month" "Day", "Hour" or "Minute"	◀ or ▶ button.
Set the "Year", "Month" "Day", "Hour" or "Minute"	▲ or ▼ button.
Press the ENTER/OK button.	

5. Press the **EXIT** button to exit.
 - If you disconnect the power cord, you have to set the clock again.
 - You can also set hour and minute by pressing the number buttons on the remote control.

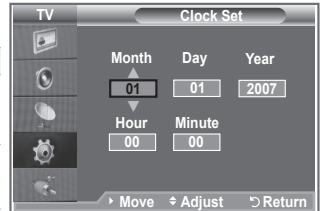
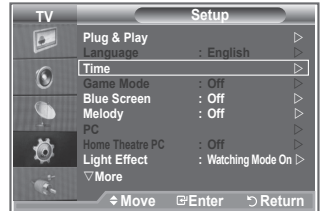

Setting the Sleep Timer

You can select a time period of between 30 and 180 minutes after which the television automatically switches to standby mode.

1. Press the **MENU** button to display the menu.
Press the **▲** or **▼** button to select "Setup", then press the **ENTER/OK** button.
2. Press the **▲** or **▼** button to select "Time", then press the **ENTER/OK** button.
3. Press the **▲** or **▼** button to select "Sleep Timer", then press the **ENTER/OK** button.
4. Press the **▲** or **▼** button until the desired time appears (Off, 30, 60, 90, 120, 150, 180).
Press the **ENTER/OK** button.
5. Press the **EXIT** button to exit.
 - The TV automatically switches to standby mode when the timer reaches 0.

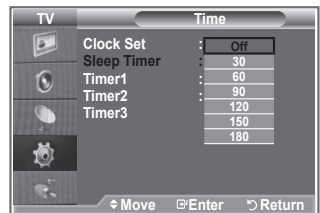
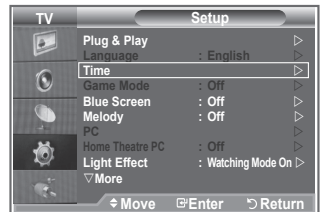

Switching the Television On and Off Automatically

You can set the On/Off timers so that the set will:

- ◆ Switch on automatically and turn to the channel of your choice at the time you select.
 - ◆ Switch off automatically at the time you select.
- > The first step is to set the television's clock.

1. Press the **MENU** button to display the menu.
Press the **▲** or **▼** buttons to select "Setup", then press the **ENTER/OK** button.
Press the **▲** or **▼** buttons to select "Time", then press the **ENTER/OK** button.
2. Press the **▲** or **▼** buttons to select "Timer 1, Timer 2, Timer 3 ", then press the **ENTER/OK** button.
3. Press the **▲** or **▼** buttons to adjust "On Timer", then press the **▶** button to move to the next step.
Set other items using the same method as above.

Repeat	Select a Once, Everyday, Mon-Fri, Mon-Sat, Sat-Sun	Press the ▲ or ▼ button
Volume	Adjust a 0~100	Press the ▲ or ▼ button
Programme	Adjust a 00~99	Press the ▲ or ▼ button

> When finished, press the **RETURN** button to return.

- The current time will appear every time you press the **INFO** button.
- You can set the hour, minute directly by pressing the number buttons on the remote control.

Press the **EXIT** button to exit.

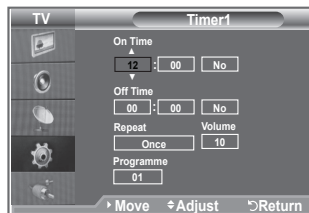

Using Game Mode

When connecting to a game console such as PlayStation™ or Xbox™, you can enjoy a more realistic gaming experience by selecting game menu.

1. Press the **MENU** button to display the menu. Press the **▲** or **▼** button to select "Setup", then press the **ENTER/OK** button.
2. Press the **▲** or **▼** button to select "Game Mode", then press the **ENTER/OK** button.
3. Press the **▲** or **▼** button to select "On" or "Off". Press the **ENTER/OK** button.
4. Press the **EXIT** button to exit.
 - > To disconnect the game console and connect another external device, cancel game mode in the Setup menu.
 - > If you display the TV menu in Game mode, the screen shakes slightly.
 - > Game Mode is not available in TV mode.
 - > If Game Mode is On:
 - Picture Mode changed to standard and Sound Mode are automatically changed to Custom and users cannot change the mode.
 - Sound Mode in the Sound menu is deactivated. Adjust the sound using the equalizer.
 - The Reset Sound function is activated. Selecting the Reset function after setting the equalizer resets the equalizer setting to the factory defaults.



Setting the Blue Screen Mode / Selecting the Melody

Blue Screen:

If no signal is being received or the signal is very weak, a blue screen automatically replaces the noisy picture background. If you wish to continue viewing the poor picture, you must set the "Blue Screen" mode to "Off".

Melody:

You can hear melody sound when the television is powered on or off.

1. Press the **MENU** button to display the menu. Press the **▲** or **▼** button to select "Setup", then press the **ENTER/OK** button.
 2. Press the **▲** or **▼** button to select "Blue Screen" or "Melody". Press the **ENTER/OK** button.
 3. When you are satisfied with your setting, press the **ENTER/OK** button.
- ◆ **Blue Screen: Off/On**
 - ◆ **Melody: Off/Low/Medium/High**
4. Press the **EXIT** button to exit.



Setting the Home Theatre PC

You can view higher quality pictures by configuring the screen settings in PC Mode.

If you set the Home Theatre PC function to On, you can configure the Detailed Settings (when Picture Mode is set to Movie) as in PC Mode.

1. Press the **MENU** button to display the menu. Press the **▲** or **▼** button to select "Setup", then press the **ENTER/OK** button.
 2. Press the **▲** or **▼** button to select "Home Theatre PC". Press the **ENTER/OK** button.
 3. Press the **▲** or **▼** button to select "On" or "Off". Press the **ENTER/OK** button.
 4. Press the **EXIT** button to exit.
- This function is available only in PC mode.

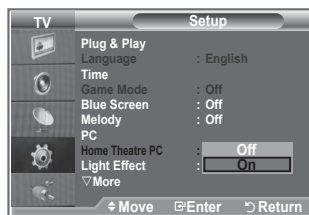

Setting the Light Effect (LA32R81BD, LA40R81BD)

You can turn on/off the blue LED on the front of TV according to the situation. Use it for saving power or when the LED dazzles your eyes.

1. Press the **MENU** button to display the menu. Press the **▲** or **▼** buttons to select "Setup", then press the **ENTER/OK** button.
2. Press the **▲** or **▼** buttons to select "Light Effect", then press the **ENTER/OK** button.
3. Press the **▲** or **▼** button to select "On", "Standby Mode On", "Watching Mode On" or "Off", then press the **ENTER/OK** button.

- **Off:** LED(Blue) will not be on
- **Standby Mode On:** Turns the LED (blue) on in standby mode
- **Watching Mode On:** Turns the LED (blue) on while watching TV.
- **On:** LED(Blue) will come on after you turn the TV off

4. Press the **EXIT** button to exit.

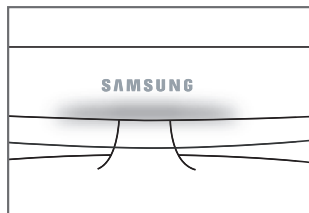

Using the Energy Saving Feature

This function adjusts the brightness of the TV so as to reduce power consumption. When you watching TV at night, set the "Energy Saving " mode option to "High" so as to reduce the dazzling of your eyes as well as the power consumption.

1. Press the **MENU** button to display the on-screen menu. Press the **▲** or **▼** button to select "Setup", then press the **ENTER/OK** button.
2. Press the **▲** or **▼** button to select "Energy Saving", then press the **ENTER/OK** button.
3. Select the required option (Off, Low, Medium, High, Auto) by pressing the **▲** or **▼** button. Press the **ENTER/OK** button.
4. Press the **EXIT** button to exit.

- **Off:** Turns off the energy saving function.
- **Low:** Sets the monitor to low energy saving mode.
- **Medium:** Sets the monitor to medium energy saving mode.
- **High:** Sets the monitor to high energy saving mode.
- **Auto:** Automatically adjusts the brightness of the TV screen in accord with the scenes.

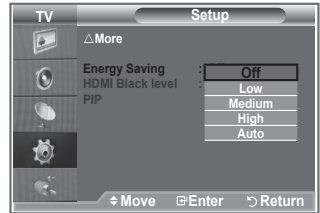
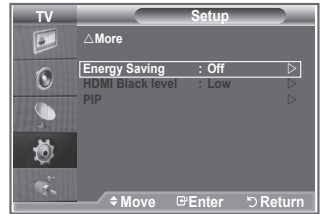

HDMI Black Level

You can directly select the black level on the screen to adjust the screen depth.

1. Press the **MENU** button to display the menu. Press the **▲** or **▼** buttons to select "Setup", then press the **ENTER/OK** button.
2. Press the **▲** or **▼** buttons to select "HDMI Black Level", then press the **ENTER/OK** button.
3. Press the **▲** or **▼** buttons to select "Normal" or "Low", then press the **ENTER/OK** button. Press the **EXIT** button to exit.
 - > This function is active only when the external input connects to HDMI and the RGB signals are input.

- **Normal:** The screen gets brighter.
- **Low:** The screen gets darker.

4. Press the **EXIT** button to exit.

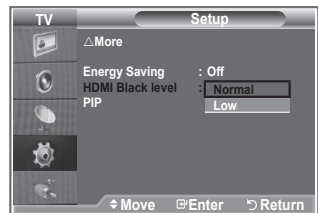
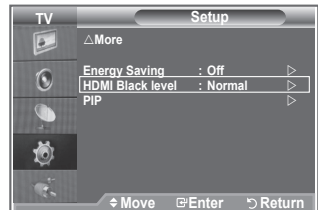

Previewing the DTV Menu System

- ◆ The company does not guarantee the normal operation of the DTV menu for countries other than the 8 supported countries (England, Germany, France, Sweden, Finland, Italy, Spain, Austria) because only these country standards are supported. In addition, when the country of the broadcast stream differs from the country selected by the current user, the string appearing in the channel banner, Info, Guide, Channel List, etc. may not be displayed properly.
- ◆ Available in DTV mode. Preset to the DTV mode by using the TV/DTV button on your remote control. To help you navigate around the on-screen menu system and adjust the various settings available, refer to the following illustration.

Press the **D.MENU** button.

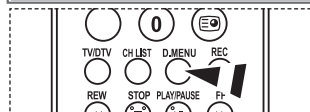
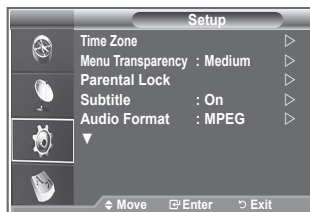
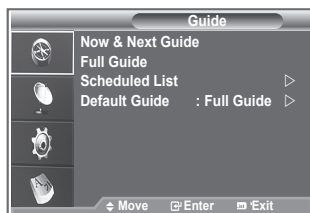
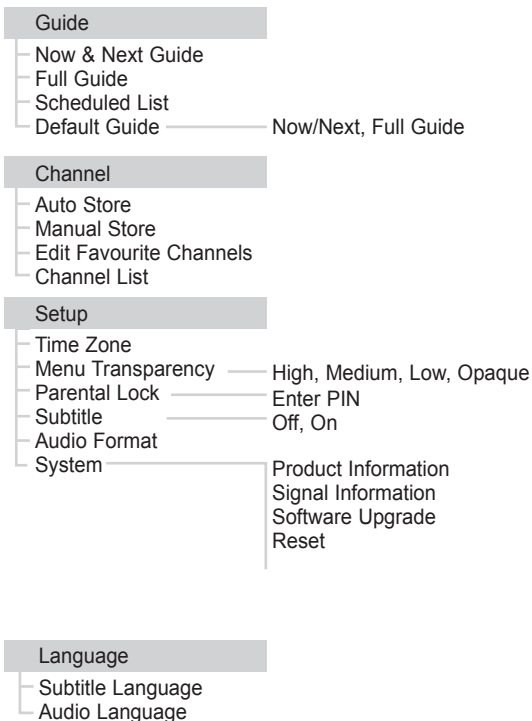

You can select these options by simply pressing the **D.MENU** button on the remote control.

Updating the Channel List Automatically

You can update the channel list when the broadcaster adds new Services or if you move the TV to a new location.

1. Press the **D.MENU** button to display the DTV menu.
2. Press the **▲** or **▼** button to select "Channel", then press the **ENTER/OK** button.
3. Press the **ENTER/OK** button again, to select "Auto Store".
4. When it has finished, the number of scanned services will be displayed.
 - The existing favourite channel list will not be deleted when the channel list is updated.
 - To stop the scan before it has finished, press the **ENTER/OK** button with "STOP" selected.
5. Press the **EXIT** button to exit.
 - If the signal status is poor, the "No Service found! Check the aerial connection" message is displayed.

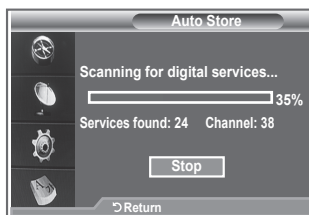

Updating the Channel List Manually

You can specify the channel for a fast channel search.

1. Press the **D.MENU** button to display the DTV menu.
2. Press the **▲** or **▼** button to select "Channel", then press the **ENTER/OK** button.
3. Press the **▲** or **▼** button to select "Manual Store", then press the **ENTER/OK** button.
4.

To...	Then...
Move to "Channel", "Frequency", or "Bandwidth"	◀ or ▶ button
Set the "Channel", or "Bandwidth"	▲ or ▼ button
Set the "Frequency"	Numeric button (0~9)

 - • **Channel:** Channel "7-12" to "21-69" in sequence are displayed in Australia
 - **Frequency:** The frequency available in the Channel group is displayed.
 - **Bandwidth:** The available bandwidths are 7MHz and 8MHz.
5. When it has finished, the number of scanned services will be displayed.
6. Press the **EXIT** button to exit.
 - You can input by pressing the button on the remote control.

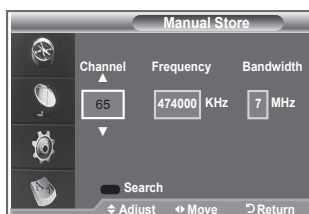

Editing Your Favourite Channels

You can edit your favourite channels using the four colour buttons.

1. Press the **D.MENU** button to display the DTV menu.
2. Press the **▲** or **▼** button to select "Channel", then press the **ENTER/OK** button.
3. Press the **▲** or **▼** button to select "Edit Favourite Channels", then press the **ENTER/OK** button.
4. Press the red button to display all currently stored channels.
5. Press the **▲** or **▼** button to select a channel you want. Press the **ENTER/OK** button.
 - A "★" icon is shown next to the selected channel and the channel will be added to the favourite channel list.
 - To undo, press the **ENTER/OK** button again.
 - **Select All:** Select all channels currently displayed.
 - **Select None:** Deselect all selected channels.
 - **Preview:** Displays (a) currently selected channel(s).
 - The Favorite Channels settings have been completed.
6. Press the **EXIT** button to exit.

◆ Add

You can use this function when one or more favourite channels have been selected.

1. Press the **D.MENU** button to display the DTV menu.
2. Press the **▲** or **▼** button to select "Channel", then press the **ENTER/OK** button.
3. Press the **▲** or **▼** button to select "Edit Favourite Channels", then press the **ENTER/OK** button.
4. Press the red button in the "Edit Favourite Channels" menu. To add more channels, refer to the step 5 on the previous description.
5. If you want to check the channel to be stored, press **D.MENU** button. Press the **EXIT** button to exit.
 - To add all channels to the favourite channel list, press the red button.
 - To remove all channels, press the green button.
 - **Preview** : Displays (a) currently selected channel(s).
 - Press the **CH LIST** button to display the favourite channel manager.

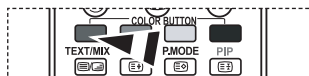
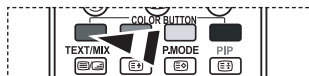

◆ Move

1. Press the **D.MENU** button to display the DTV menu.
2. Press the **▲** or **▼** button to select "Channel", then press the **ENTER/OK** button.
3. Press the **▲** or **▼** button to select "Edit Favourite Channels", then press the **ENTER/OK** button.
4. Select the required channel using the **▲** or **▼** button.
5. Press the green button.
 - > A "↕" icon is displayed on the left side of the channel name.
6. Press the **▲** or **▼** button to select the channel that you want to move, and press the green or **ENTER/OK** button.
7. Press the **EXIT** button to exit.

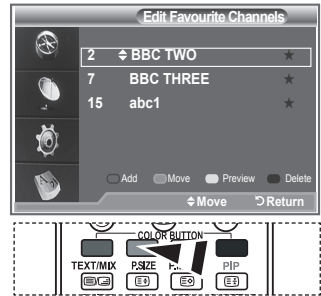

◆ Preview

1. In the "Edit Favourite Channels" menu, select the channel to be previewed by pressing the **▲** or **▼** button.
2. Press the yellow button.
 - > The selected channel is displayed on the screen.

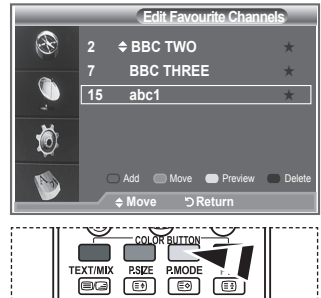

◆ Delete

1. In the "Edit Favourite Channels" menu, select the channel to be deleted from the favourite channels list by pressing the **▲** or **▼** button.
2. Press the blue button.
 - > The selected channel and number will be deleted.
 - > To add a deleted channel back into the favourite channel list, see "Add" on page 34.

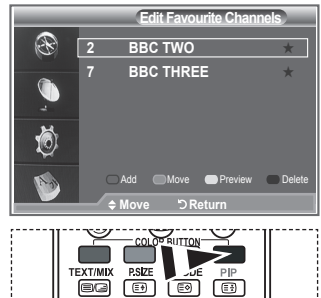

Selecting Channel List

You can exclude the channels you have chosen from the channels you have scanned. When you scan through the stored channels, those you have chosen to skip are not displayed. All channels that you do not specifically choose to skip are displayed during scanning.

1. Press the **D.MENU** button to display the DTV menu.
2. Press the **▲** or **▼** button to select "Channel", then press the **ENTER/OK** button.
3. Press the **▲** or **▼** button to select "Channel List". Press the **ENTER/OK** button.
4. Press the yellow button to toggle between your favourite channels and all channels.
 - Your favourite channels are only displayed if they were previously set in the "Editing Your Favourite Channels" menu.
5. Press the red or green button to display the previous or next channel List page.
6. Press the blue button to display TV, Radio, Other and All.
7. Press the **▲** or **▼** button to select a channel to be tuned. Press the **ENTER/OK** button.
 - The channel number, name and an icon are displayed in the top left corner while changing the channel. The channel number and name are displayed if the channel is one of the all channels, and a **★** icon if the channel is one of the favourite channels.
8. Press the blue or **CH LIST** button to exit from the channel List.

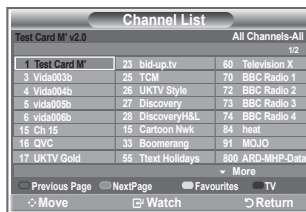

Channel List		
Test Card M v2.0		All Channels-All
		1/2
1 Test Card M	23 bid-up.tv	60 Television X
3 Video03b	25 TCM	70 BBC Radio 1
4 Video04b	26 UKTV Style	72 BBC Radio 2
5 video05b	27 Discovery	73 BBC Radio 3
6 video06b	28 DiscoveryH&L	74 BBC Radio 4
15 Ch 15	15 Cartoon Nwk	84 heat
16 QVC	33 Boomerang	91 MOJO
17 UKTV Gold	55 Text Holidays	800 ARO-MHP-Data

More

Previous Page NextPage Favourites TV

Move Watch Return

Displaying Programme Information

While viewing a channel, additional information about the current programme may be displayed.

1. While viewing a programme, press the **INFO** button.
 - The programme information is displayed.
2. To exit from banner information, press the **INFO** button.

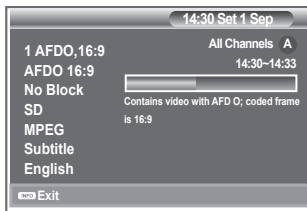
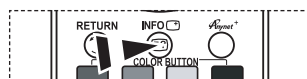

Viewing the EPG (Electronic Programme Guide) Information

The EPG (Electronic Programme Guide) information is provided by the broadcasters. Programme entries may appear blank or out of date as a result of the information broadcast on a given channel. The display will dynamically update as soon as new information becomes available.

◆ Now & Next Guide

For the six channels indicated in the left-hand column, displays the Current programme and the Next programme information.

◆ Full Guide

Displays the programme information as time ordered One hour segments. Two hours of programme information is displayed which may be scrolled forwards or backwards in time.

1. Press the **D.MENU** button to display the DTV menu.
2. Press the **ENTER/OK** button, to select "Guide".
3. Press the **▲** or **▼** button to select "Now & Next Guide" or "Full Guide".
Press the **ENTER/OK** button.
➤ You can also display the guide menu simply by pressing the **GUIDE** button.

4. To...	Then...
Watch a programme in the EPG list	<ul style="list-style-type: none"> • Select a programme by pressing the ▲, ▼, ◀, ▶ button. • Press the ENTER button.
View programme information	<ul style="list-style-type: none"> • Select a programme of your choice by pressing the ▲, ▼, ◀, ▶ button. • Press the INFO button when the programme of your choice is highlighted.
Toggle between the "Now & Next Guide" or "Full Guide"	<ul style="list-style-type: none"> • Press the red button repeatedly.
Display the "Favourites" and the "All Channels" list	<ul style="list-style-type: none"> • Press the green button repeatedly.
Scrolls backwards quickly (24 hours).	<ul style="list-style-type: none"> • Press the yellow button repeatedly.
Scrolls forward quickly (24 hours).	<ul style="list-style-type: none"> • Press the blue button repeatedly.
Exit the guide	<ul style="list-style-type: none"> • Press the EXIT button.

- The programme title is on the upper part of the screen center. Please click on **INFO** button for the detailed information. Channel Number, Running Time, Status Bar, Parental Level, Video Quality Information(HD/SD), Sound Modes, Subtitle or Teletext, Languages of Subtitle or Teletext, and brief summary of the highlighted programme are included on the detailed information. "..." will be appeared if the summary is long.
- Six channels are displayed. To scroll between channels, move to a channel using the **▲** or **▼** button. To display page by page, use the **P** (◀) or (▶) button.

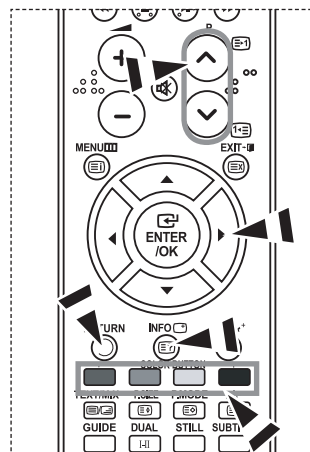

Using the Scheduled List

If you make a scheduled viewing list of programs you may like to see, the channel will be automatically switched to the scheduled program at the scheduled time even if you are watching another program.

1. Press the **D.MENU** button to display the DTV menu.
2. Press the **ENTER/OK** button, to select "Guide".
3. Press the **▲** or **▼** button to select "Scheduled List", then press the **ENTER/OK** button.
4. Press the red button.
The channel will be switched to the scheduled program.
5. Press the **ENTER/OK** button to select an item and adjust with the **◀** or **▶** button .
 - You can also set hour and minute by pressing the number buttons on the remote control.
 - **Channel:** Set the channel.
 - **Time:** Set the time.
 - **Date:** Set Year, Month and Day.
 - **Frequency:** Set the frequency.
("Once", "Daily", or "Weekly")
6. After setting the schedule, Press the red button.
7. Press the **EXIT** button to exit.
 - The Scheduled list may be displayed in the EPG menu.
 - • **Save:** Save the adjusted schedule.
 - **Cancel:** Cancel the adjusted schedule.
 - **Add Programme:** Add a new schedule.
 - **Edit:** Re-adjust the selected schedule.
 - **Delete:** Delete the selected schedule.

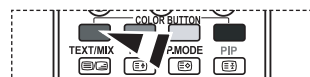
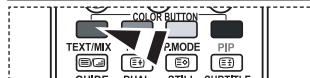

Setting the Default Guide

You can preset the default guide style.

1. Press the **D.MENU** button to display the DTV menu.
2. Press the **ENTER/OK** button, to select "Guide".
3. Press the **▲** or **▼** button to select "Default Guide", then press the **ENTER/OK** button.
4. Select "Now/Next" or "Full Guide" using the **▲** or **▼** button, and press the **ENTER/OK** button.
5. Press the **EXIT** button to exit.



 You can select these options by simply pressing the **GUIDE** button on the remote control.

Viewing All Channels and Favourite Channels

In the EPG menu, you can display all channels or favourite channels.

1. Press the **D.MENU** button to display the DTV menu.
2. Press the **ENTER/OK** button again, to select "Guide".
3. Select the your required guide ("Now & Next Guide" or "Full Guide") by pressing the **▲** or **▼** button.
4. Press the **ENTER/OK** button.
5. Press the green button.
All the channel lists and the favorite channel lists will be toggled.
6. Select a programme of your choice by pressing the **▲**, **▼**, **◀** or **▶** button.
7. Press the **INFO** button to display information about the highlighted programme.
8. When the Edit Favourite Channels list has not been set up:
 - "The favourites list is empty. Would you like to choose your favourites now?" message is displayed.
 - Select "Yes".
The "Edit Favourite Channels" menu is displayed.
If you select "No", all channels will remain unchanged.
 - To edit the favourite channels, refer to page 34 for more details.
9. Press the **EXIT** button to exit.
 - "All Channels" is the list of channels that have been scanned by the channel list update.
All channels are displayed in the all channel mode.
 - "Favourites" (favourite channels) is the list of channels that has been set in the "Edit Favourite Channels" menu (refer to page 34).

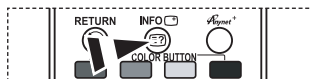
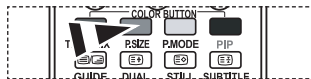

Selecting the Time Zone

Select the time zone where locate

1. Press the D.MENU button.
2. Press the **▲** or **▼** button to select "Setup", then press the **ENTER/OK** button
3. Press the **▲** or **▼** button to select Time Zone, then press the **ENTER/OK** button
4. Select the time zone where you locate by pressing the **▲** or **▼** button.
Press the **ENTER/OK** button.
 - The following options are available.
New South Wales/ACT - Victoria - Queensland
- South Australia - Western Australia - Tasmania
- Northern Territory
5. Press the **EXIT** button to exit.

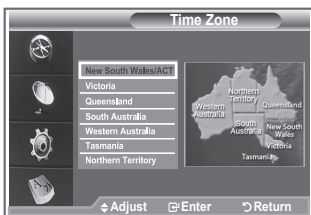

Adjusting the Menu Translucency

You can set the translucency of the menu.

1. Press the **D.MENU** button to display the DTV menu.
2. Press the **▲** or **▼** button to select "Setup", then press the **ENTER/OK** button.
3. Press the **▲** or **▼** button to select "Menu Transparency" then press the **ENTER/OK** button.
4. Select the required option ("High", "Medium", "Low", or "Opaque") by pressing the **▲** or **▼** button, and press the **ENTER/OK** button to change the setting.
5. Press the **EXIT** button to exit.

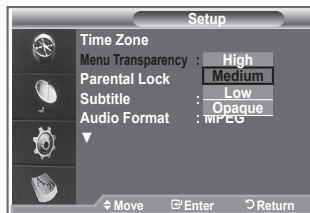

Setting up the Parental Lock

This feature allows you to prevent unauthorized users, such as children, from watching unsuitable programmes by a 4-digit PIN (Personal Identification Number) code that is defined by the user. The on-screen menu will instruct you to assign a PIN code (you can change it later, if necessary).

1. Press the **D.MENU** button to display the DTV menu.
2. Press the **▲** or **▼** button to select "Setup", then press the **ENTER/OK** button.
3. Press the **▲** or **▼** button to select "Parental Lock.", then press the **ENTER/OK** button.
4. The "Enter PIN" is displayed.
5. Enter your current 4-digit PIN code by using the numeric buttons (0~9).
The options available in the "Parental Lock" group are displayed with the "Parental Rating" selected.
 - > The default PIN code for a new TV set is 0000.
 - > If you enter an invalid PIN code, the "Invalid PIN code. Please try again." message is displayed.
6. Press the **ENTER/OK** button.
7. Press the **▲** or **▼** button to select the age rating you want to lock out.
Press the **ENTER/OK** button.
8. If you want to change the PIN code, select "Change PIN" by pressing the **▲** or **▼** button. Press the **ENTER/OK** button.
 - > The "Enter New PIN" is displayed.
9. Enter your new PIN code by using the numeric buttons (0~9).
 - > The "Confirm New PIN" is displayed.
10. Re-enter your new PIN code to confirm by using the numeric buttons (0~9).
 - > The "Your PIN code has been changed successfully" message is displayed.
11. Press the **ENTER/OK** button.
12. Press the **EXIT** button to exit.
 - > If you forget the PIN code, press the remote control buttons in the following sequence, which resets the PIN to **0-0-0-0**: **POWER (Off)**, **MUTE**, **8**, **2**, **4**, **POWER (On)**.

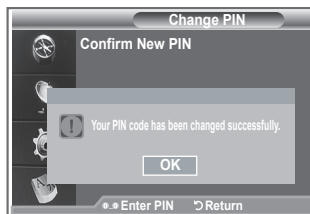
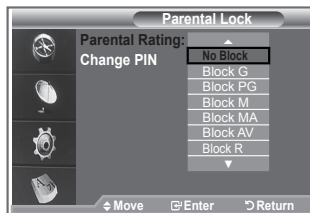
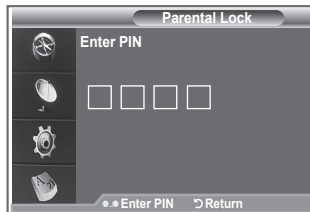

Setting the Subtitle

You can activate and deactivate the subtitles.

1. Press the **D.MENU** button to display the DTV menu.
2. Press the **▲** or **▼** button to select "Setup", then press the **ENTER/OK** button.
3. Press the **▲** or **▼** button to select "Subtitle" Press the **ENTER/OK** button again, to select "Subtitle".
4. Select "On", "Off" by pressing the **▲** or **▼** button. Press the **ENTER/OK** button.
5. Press the **EXIT** button to exit.



Selecting the Audio Format

You can only hear Dolby Digital sound through the audio receiver connected through an optical cable. You can only hear PCM sound through the main speaker.

When sound is emitted from both the main speaker and the audio receiver, a sound echo may occur due to the decoding speed difference between the main speaker and the audio receiver. In this case, use the internal mute function.

1. Press the **D.MENU** button to display the DTV menu.
2. Press the **▲** or **▼** button to select "Setup", then press the **ENTER/OK** button.
3. Press the **▲** or **▼** button to select "Audio Format", then press the **ENTER/OK** button.
4. Press the **EXIT** button to exit.
 - > The Audio Format appears according to the broadcasting signal.
 - > Dolby digital sound is only available when the TV is connected with an external speaker using an optical cable.

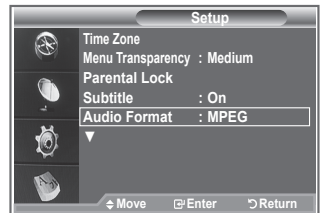

Viewing Product Information

You can view your product information. For service or repair, please contact a Samsung approved dealer.

1. Press the **D.MENU** button to display the DTV menu.
2. Press the **▲** or **▼** button to select "Setup", then press the **ENTER/OK** button.
3. Press the **▲** or **▼** button to select "System", then press the **ENTER/OK** button.
4. Press the **ENTER/OK** button again, to select "Product Information".
 - > The Product Information menu is selected.
 - Software Version.
5. Press the **EXIT** button to exit.

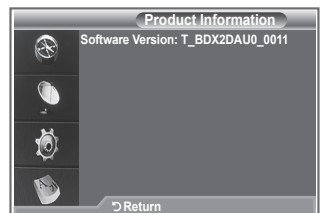

Checking the Signal Information

You can get information about the signal status.

1. Press the **D.MENU** button to display the DTV menu.
2. Press the **▲** or **▼** button to select "Setup", then press the **ENTER/OK** button.
3. Press the **▲** or **▼** button to select "System", then press the **ENTER/OK** button.
4. Press the **▲** or **▼** button to select "Signal Information", then press the **ENTER/OK** button.
5. Press the **EXIT** button to exit.
 - > If the signal status is poor, the "No signal." message is displayed.

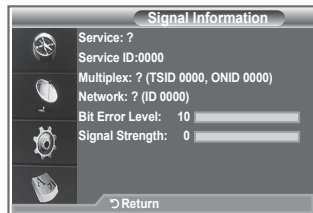

Upgrading the Software

To keep your product up-to-date with new Digital Television features then software upgrades are periodically broadcast as part of the normal Television signal.

It will automatically detect these signals and display the software upgrade banner. You are given the option to install the upgrade.

▪ Upgrade Now

If you select Upgrade Now, the iDTV immediately installs the new upgrade and then restarts.

▪ Upgrade Later

If you select Upgrade Later, the upgrade is postponed until the next restart or channel change some 90 minutes later, when the upgrade dialog appears again.

▪ Don't Upgrade

If you select Don't Upgrade, the iDTV does not perform the upgrade and the software upgrade banner is not displayed again.

The upgrade is still stored internally, to subsequently upgrade to the new version then the following sequence of steps are performed.

Alternatively, you can manually upgrade the software.

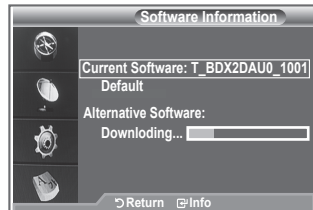
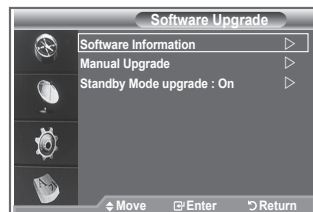
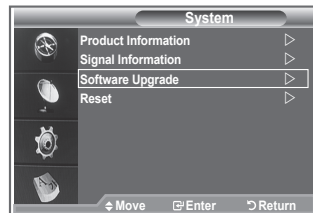

1. Press the **D.MENU** button to display the DTV menu.
2. Press the **▲** or **▼** button to select "Setup", then press the **ENTER/OK** button.
3. Press the **▲** or **▼** button to select "System", then press the **ENTER/OK** button.
4. Press the **▲** or **▼** button to select "Software Upgrade", then press the **ENTER/OK** button.
5. Press the **▲** or **▼** button to select "Software Information", "Manual Upgrade" or "Standby Mode upgrade". Press the **ENTER/OK** button.

◆ **Software Information**

Press the **ENTER/OK** button, then the current software version is shown. Then you can upgrade the software as the pictures.

◆ **Manual Upgrade**

Press the **ENTER/OK** button to search for new software from the currently broadcasting channels. The operations are same as you enter the software information.

◆ **Standby Mode Upgrade : On / Off**

Press the **ENTER/OK** button. To continue software upgrade with master power on, Select On by pressing the **▲** or **▼** button.

45 minutes after entering standby mode, a manual upgrade is automatically conducted. Since the power of the unit is turned on internally, the screen may be on slightly for the LCD product. This phenomenon may continue for more than 1 hour until the software upgrade is completed.

6. To switch to an alternative version, press the red button. Press the blue button to reset, activate the upgrade and restart.
7. Press the **EXIT** button to exit.

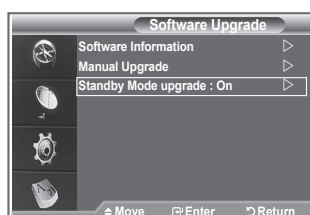
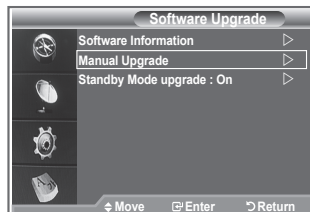
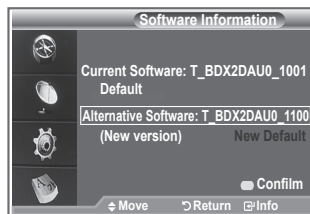
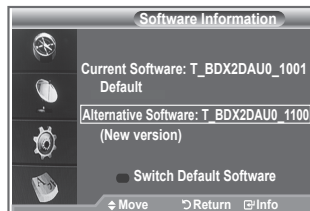
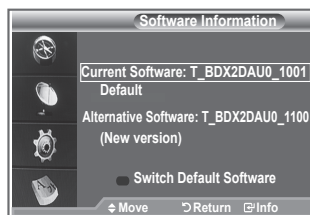

Resetting

You can reset the values stored to the factory default values.

- > The Reset operation deletes all channel information and user preferences returning all values to their default factory state.
- 1. Press the **D.MENU** button to display the DTV menu.
- 2. Press the **▲** or **▼** button to select "Setup", then press the **ENTER/OK** button.
- 3. Press the **▲** or **▼** button to select "System", then press the **ENTER/OK** button.
- 4. Press the **▲** or **▼** button to select "Reset", then press the **ENTER/OK** button.
- 5. The "Enter PIN" screen will appear.
- 6. Enter your current 4-digit PIN code by using the numeric buttons (0~9).
 - > The warning message is displayed. All values will be reset by pressing the coloured buttons (red, green, yellow, and blue) in turn.
- 7. Press the **EXIT** button to exit.

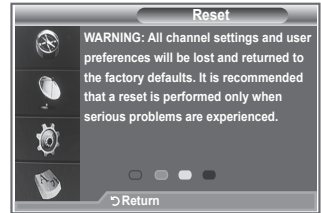
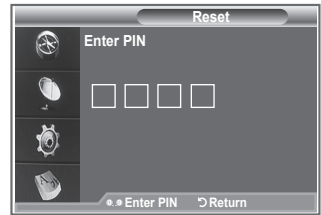

Selecting the Preferred Language (Subtitle , Audio)

You can change the default value for subtitle, audio languages.

Displays the language information for the incoming stream.

1. Press the **D.MENU** button to display the DTV menu.
 2. Press the **▲** or **▼** button to select "Language", then press the **ENTER/OK** button.
 3. Press the **▲** or **▼** button to select "Subtitle Language", "Audio Language". Press the **ENTER/OK** button.
 4. Select a particular language by pressing the **▲** or **▼** button repeatedly. Press the **ENTER/OK** button.
 - > English is the default in cases where the selected language is unavailable in the broadcast.
 5. Press the **EXIT** button to exit.
- > While viewing a programme, the subtitle can be selected. While viewing a programme, audio languages can be selected.

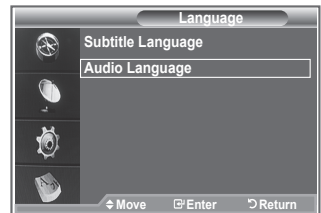

Selecting the Source

You can select among external sources connected to your TV's input jacks.

1. Press the **MENU** button to display the menu.
Press the **▲** or **▼** button to select "Input", then press the **ENTER/OK** button.
2. Press the **ENTER/OK** button again, to select "Source List".
> When no external device is connected to your set, only "TV", "DTV" are activated in the "Source List".
"AV1", "AV2" "S-Video", "Component1", "Component2", "PC", "HDMI1", "HDMI2", "HDMI3" are activated only when they are connected to your set.
3. Select the required device by pressing the **▲** or **▼** button.
Press the **ENTER/OK** button.

-  Press the **SOURCE** button on the remote control to toggle between all the available source.
TV mode can be selected by pressing the **TV /DTV** button, number buttons(0~9), and the **PC** button on the remote control. But it cannot be selected using the **SOURCE** button.

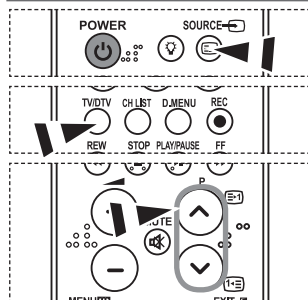
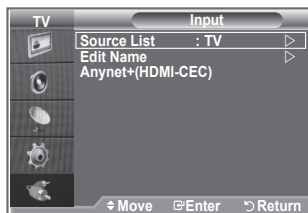

Editing the Input Source Names

Name the device connected to the input jacks to make your input source selection easier.

1. Press the **MENU** button to display the menu.
Press the **▲** or **▼** button to select "Input", then press the **ENTER/OK** button.
2. Press the **▲** or **▼** button to select "Edit Name", then press the **ENTER/OK** button.
3. Press the **▲** or **▼** button to select the device that you wish to edit.
Press the **ENTER/OK** button.
4. Press the **▲** or **▼** button to select the required device.
Press the **ENTER/OK** button.
5. Press the **EXIT** button to exit.

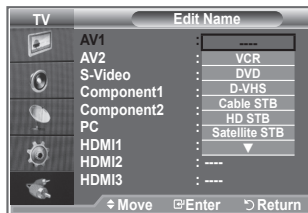
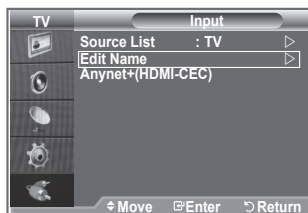

Teletext Decoder

Most set channels carry " teletext ", pages of written information that provide information such as:

- ◆ Television programme times.
- ◆ News bulletins and Weather forecasts.
- ◆ Sports results.
- ◆ Subtitles for the hard of hearing.

The teletext pages are organized according to six categories:

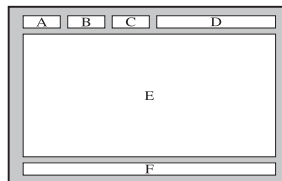

Part	Contents
A	Selected page number.
B	Broadcasting station identity.
C	Current page number or search status.
D	Date and time.
E	Text.
F	Status information.

Displaying the Teletext Information

You can display teletext information at any time, but signal reception must be good. Otherwise:

- ◆ Information may be missing.
- ◆ Some pages may not be displayed.

To activate the teletext mode and display the contents page:

1. Using the **P** (TV) or **P** (DTV) button, select the channel providing the teletext service.
2. Press the **TEXT/MIX** (TV) button to activate the teletext mode.
 - The contents page is displayed. It can be redisplayed at any time by pressing the **MENU** (TV) button.
3. Press the **TEXT/MIX** (TV) button again.
 - The actual broadcast will be displayed with "Teletext", "Double", and "Mix" in order on the screen.
4. Press the **TV/DTV** button to exit from the Text display.
 - If any broken character appears while Text is being viewed, make sure that the Text language is identical with the language in the "Setup" menu mode. If both languages are different, select the same language with the Text language on the "Setup" menu.

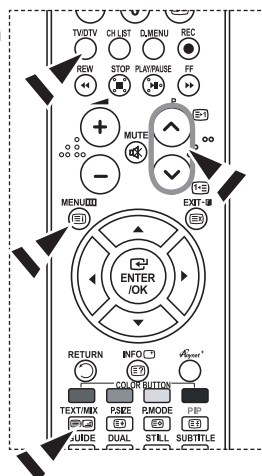

Selecting a Specific Teletext Page

Press the number buttons on the remote control to enter the page number directly:

1. Enter the three-digit page number listed in the contents by pressing the corresponding numeric buttons.
2. If the selected page is linked with several secondary pages, the secondary pages are displayed in sequence. To freeze the display on a given page, press the **PIP** (E3). Press the **PIP** (E3) button again to resume.
3. Using the various display options:

To display...	Press the...
Both teletext information and the normal broadcast	TEXT/MIX (E1/E2)
Hidden text (answers to quiz games, for example)	INFO (E2)
The normal screen	INFO (E2)
A secondary page, by entering its 4-digit number	PRE-CH (E4)
The next page	P (E1)
The previous page	P (E2)
Double-size letters in the: <ul style="list-style-type: none"> • Upper half of the screen • Lower half of the screen 	P.SIZE (E3) <ul style="list-style-type: none"> • Once • Twice
Normal screen	• Three times

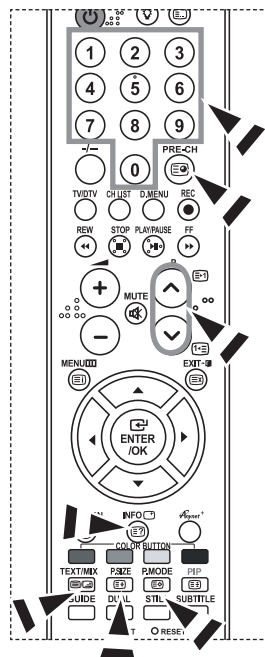

Using Fastext to Select a Teletext Page

The various topics included in the teletext pages are colour-coded, and can be selected by pressing the coloured buttons on the remote control.

1. Display the teletext contents page by pressing the **TEXT/MIX** (E1/E2) button.
2. Press the coloured button corresponding to the topic that you wish to select (The available topics are listed on the status information line).
3. Press the Red button to display the previous page.
Press the Green button to display the next page.
4. Press the **TV/DTV** button to exit from the Text display.

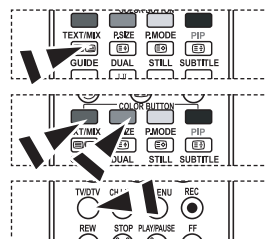

Setting Up Your Remote Control

After it has been set up properly, your remote control can operate in five different modes: TV, DVD, Cable, Set-Top Box, VCR. Pressing the corresponding button on the remote control allows you to switch between these modes, and control whichever piece of equipment you choose.

- The remote control might not be compatible with all DVD Players, VCRs, Cable boxes, and Set-Top Boxes.

Setting Up the Remote to Operate Your VCR

1. Turn off your VCR.
 2. Press the **VCR** button on your TV's remote control.
 3. Press the **SET** button on your TV's remote control.
 4. Using the number buttons on your remote control, enter three digits of the VCR code listed on page 50 of this manual for your brand of VCR. Make sure you enter three digits of the code, even if the first digit is a "0". (If more than one code is listed, try the first one.)
 5. Press the **POWER** button on the remote control. Your VCR should turn on if your remote is set up correctly. If your VCR does not turn on after set up, repeat steps 2, 3, and 4, but try one of the other codes listed for your brand of VCR. If no other codes are listed, try each VCR code, 000 through 083.
- Note on Using Remote Control Modes: VCR
When your remote control is in "VCR" mode, the volume buttons still control your TV's volume.

Setting Up the Remote to Operate Your Cable Box

1. Turn off your cable box.
 2. Press the **CABLE** button on your TV's remote control.
 3. Press the **SET** button on your TV's remote control.
 4. Using the number buttons on your remote control, enter three digits of the cable box code listed on page 51 of this manual for your brand of cable box. Make sure you enter three digits of the code, even if the first digit is a "0". (If there is more than one code listed, try the first one.)
 5. Press the **POWER** button on the remote control. Your cable box should turn on if your remote is set up correctly. If your cable box does not turn on after set up, repeat steps 2, 3, and 4, but try one of the other codes listed for your brand of cable box. If no other codes are listed, try each code, 000 through 046.
- Note on Using Remote Control Modes: Cable Box
When your remote control is in "CABLE" mode, the volume buttons still control your TV's volume.

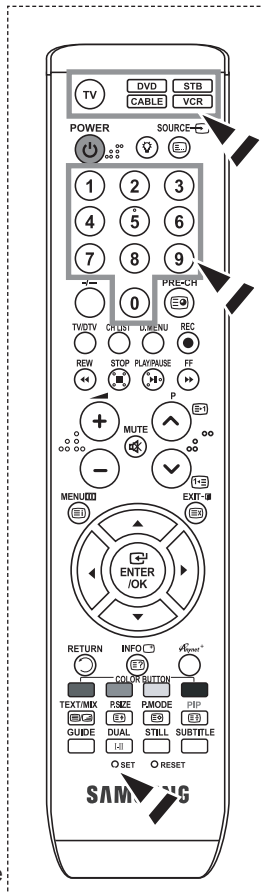

Setting Up the Remote to Operate Your DVD

1. Turn off your DVD.
 2. Press the **DVD** button on your TV's remote control.
 3. Press the **SET** button on your TV's remote control.
 4. Using the number buttons on your remote control, enter three digits of the DVD code listed on page 51~52 of this manual for your brand of DVD. Make sure you enter three digits of the code, even if the first digit is a "0". (If there is more than one code listed, try the first one.)
 5. Press the **POWER** button on the remote control. Your DVD should turn on if your remote is set up correctly. If your DVD does not turn on after set up, repeat steps 2, 3, and 4, but try one of the other codes listed for your brand of DVD. If no other codes are listed, try each code, 000 through 146.
- Note on Using Remote Control Modes: DVD
When your remote control is in "DVD" mode, the volume buttons still control your TV's volume.

Setting Up the Remote to Operate Your STB

1. Turn off your STB.
 2. Press the **STB** button on your TV's remote control.
 3. Press the **SET** button on your TV's remote control.
 4. Using the number buttons on your remote control, enter three digits of the STB code listed on page 52 of this manual for your brand of STB. Make sure you enter three digits of the code, even if the first digit is a "0". (If there is more than one code listed, try the first one.)
 5. Press the **POWER** button on the remote control. Your STB should turn on if your remote is set up correctly. If your STB does not turn on after set-up, repeat steps 2, 3 and 4, but try one of the other codes listed for your brand of STB. (If no other codes are listed, try each code, 000 through 074.)
- Note on Using Remote Control Modes: STB
When your remote control is in "STB" mode, the volume buttons still control your TV's volume.

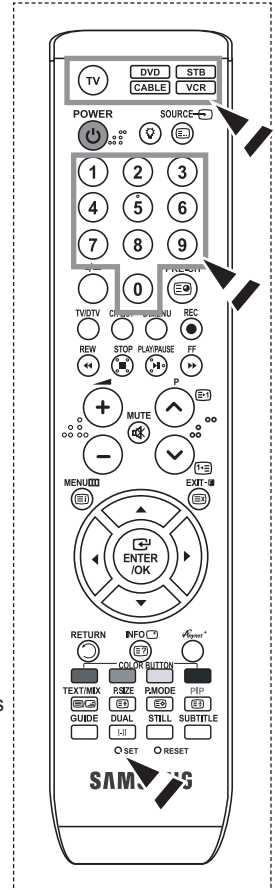

Remote Control Codes

> VCR

Brand	Code
SAMSUNG	000 001 002 003 004 005 077 078 079
ADMIRAL	020
AIWA	025
AKAI	004 027 032
AUDIO DYNAMICS	007 026
BELL&HOWELL	018
BROKSONIC	022
CANDLE	002 003 006 008 015 055
CANON	021 056
CITIZEN	002 003 006 008 015 055
COLORTYME	007
CRAIG	002 024
CURTIS MATHES	002 007 008 017 021 025 056 064 066
DAEWOO	003 010 011 012 013 014 015 016
DB	007 026
DIMENSIA	017
DYNATECH	025
ELECTROHOME	034
EMERSON	001 003 006 021 022 025 030 032 034 040 047 050 052 060 063 065 066 067 069 073
FISHER	018 024 028 029 048 051 061
FUNAI	025
GENERAL ELECTRIC	002 005 017 021 056
GO VIDEO	002
HARMAN KARDON	007
HITACHI	019 025 041 042 074
INSTANT REPLAY	021
JC PENNEY	002 007 018 019 021 026 037 041 054 056
JCL	007 008 018 021 026 037
JVC	081 082 083
KENWOOD	007 008 018 021 026 037
KLH	070
KONIA	036
LG(Goldstar)	006 007 008 009 010
LLOYD	025
LOGIK	038
LXI	025
MAGNAVOX	021 056 059
MARANTZ	007 008 018 021 026 037 062
MARTA	006
MEI	021
MEMOREX	006 021 024 025
MGA	034
MIDLAND	005
MINOLTA	019 041 075
MITSUBISHI	019 034 041 046

Brand	Code
MONTGOMERY WARD	020
MTC	002 025
MULTITECH	002 005 025 038
NEC	007 008 018 026 037 062 064
OPTIMUS	020
ORION	073 074 075 076
PANASONIC	021 056 071 072
PENTAX	019 041 075
PENTEX RESEARCH+	008
PHILCO	021 056 059
PHILIPS	021 080
PIONEER	019 026 039 053
PORTLAND	015 049 055
PROSCAN	017
QUARTZ	018
QUASAR	021 056
RADIO SHACK/ REALISTIC	006 018 020 021 024 025 029 034 048 056
RCA	002 017 019 021 035 041 043 057 068 076
SANSUI	026
SANYO	018 024
SCOTT	003 047 052 067
SEARS	006 018 019 024 028 029 041 048 051
SHARP	020 034 045 015
SHIMTOM	027 033 038 058
SIGNATURE	025
SONY	027 033 044
SYLVANIA	021 025 056 059
SYMPHONIC	025
TANDY	018 025
TASHIKA	006
TATUNG	037
TEAC	025 037 068
TECHNICS	021
TEKNIKA	006 021 025 031
TMK	066
TOSHIBA	003 019 029 051 052
TOTEVISION	002 006
UNITECH	002
VECTOR RESEARCH	007 026
VICTOR	026
VIDEO CONCEPTS	007 026
VIDEOSONIC	002
WARDS	002 003 006 019 020 021 024 025 034 038 041
YAMAHA	007 008 018 026 037
ZENITH	023 027 033

➤ **CABLE BOX**

Brand	Code
SAMSUNG	000 001 002 003 004 005 006 007
GI	041
HAMLIN	003 024 031
HITACHI	025 030
JERROLD	038 039
MACOM	025 030
MAGNAVOX	019 023 028
OAK	026
PANASONIC	003 022 027 037 044
PHILIPS	019 021 023 028
PIONEER	004 018 020 044
RCA	014 022 040
REGAL	003

➤ **SAMSUNG DVD**

Product	Code
DVD	000 001 002
DVDR	003 004
BD Record	005 006
VCR COMBO	007 008 009 010 011
VCR Record	012
DHR COMBO	013

➤ **DVD**

Brand	Code
ANAM	030
AUDIOVOX	075
AUDIOLOGIC	085
ANABA	072
APEX DIGITAL	070 071 074 086 083 084 088 111 112
AIWA	114
BROKSONIC	062
BLAUPUNKT	074
B&K	122 123
CURTIS MATHES	027
CYBER HOME	077 078 079 082
CLARION	080 125
CIRRUS	081
CYBER HOME	065
CINEVISION	095
DAEWOO	066
DENON	146
FARENHEIT	067 068
FISHER	090
GPX	060
GO VIDEO	061 089 133 135
GE	069 074
GREENHILL	074
HITACHI	064 113
HITEKER	071
HOYO	073
HARMAN / KARDON	091 110
IRT	089

Brand	Code
REGENCY	015 023
SA	042 043
SCIENTIFIC ATLAN	042 043
SPRUCER	022
STARGATE 2000	036
SYLVANIA	016
TEXSCAN	016
TOCOM	032
UNIVERSAL	033 034
VIEWSTAR	019 021 023 028
WAMER AMEX	046
ZENITH	017 029 035 037 045

Product	Code
Home Theater VCR COMBO	014 015 016
HDD Recorder COMBO	017
TWIN TRAY COMBO	018
STB DVD COMBO	019
DVD Receiver	020
AV Receiver	021

Brand	Code
INTEGRA	092
JBL	091
JVC	022 033 115 116
JATON	073
KENWOOD	051 108 109
KISS	073
KONKA	059 100 106 107
KLH	074 075
LG(Goldstar)	025 031
LOEWE	057
LASONIC	058
MOBILE AUTHORITY	054
MEMOREX	055
MALATA	056
MAGNAVOX	076 093
MINTEK	074 094
MONYKA	073
NORCENT	048 049 050
NEXT BASE	052
NEC	053
NANTAUS	144
NESA	074
OPTOMEDIA ELECTRONICS	105
OPTIVIEW	072
ONKYO	076 092 119
PHILCO	044 045
PRINCETON	046 047
PROSCAN	023

➤ DVD

Brand	Code
PANASONIC	024 034 124 134 136 137 138
PHILIPS	036 076
ROTEL	117 118
RIO	120
RCA	023 035 074 075 131 132
RAITE	073
ROWA	038
SAMPO	104
SONY	026 029 126 127 128 129 130 141
SHERWOOD	039 041
SVA	042
SYLVANIA	043 093
SHARP	140
SANSUI	062
SANYO	062 090
SHINSONIC	094

Brand	Code
THOMSON	145
TOSHIBA	028 062 076
TECHNICS	139
TVIEW	072
TOKAI	073
TEAC	096
TECHWOOD	097
TREDEX	098 099 101
URBAN CONCEPTS	076
VENTURER	075
VOCOPRO	102
YAMAHA	032 063
YAMAKAWA	040 073
XWAVE	103
ZENITH	076 121

➤ SAMSUNG SET-TOP BOX

Product	Code
Ground wave STB	001 002
Satellite STB	003
CABLE STB	004
STB DVD COMBO	008
Satellite STB HDD COMBO Standard	009

Product	Code
Satellite STB HDD COMBO Premium	010
CABLE STB HDD COMBO Standard	011
CABLE STB HDD COMBO Premium	012
Ground wave STB HDD COMBO Standard	013
Ground wave STB HDD COMBO Premium	014

➤ SET-TOP BOX

Brand	Code
ALPHASTAR	023
ANAM	043
CHANNEL MASTER	018 034
CROSSDIGITAL	019
CHAPARRAL	035
DIRECT TV	015 016 017 019 022 045 060 061 062 065 066 067 068
DAEWOO	074
DISH NETWORK SYSTEM	069 070
DISHPRO	069
DRAKE	018 024 032
DX ANTENNA	027
EHOSTAR	025 069 070 071
EXPRESSVU	069
GOI	069
GE	065
GENERAL INSTRUMENT	046 047 048 063 064
HTS	069
HOME CABLE	056
HITACHI	022
HUGHES NETWORK	015 017
IQ	020
IQ PRISM	020
JANEIL	059
JERROID	063
JVC	069 070
LG(Goldstar)	044 073

Brand	Code
MAGNAVOX	016 021 036 038 039 040 041 042
MEMOREX	016
MOTOROLA	064
MACOM	018
MITSUBISHI	015
NEXT LEVEL	047 048 064
PHILIPS	015 016 017 021 033 036 038 039 040 041 042 067
PRIMESTAR	046 049 050 063
PANASONIC	058 059 061 062
PAYSAT	016
PROSCAN	065 066
RCA	051 052 053 065 066
RADIOSHACK	064
REALISTIC	057
STAR TRAK	026
STS	020 027
SKY	031
SKY LIFE	005 006 007
SHACK	064
STAR CHOICE	064
SONY	054 060
TOSHIBA	015 017 028 029 030 072
ULTIMATE TV	060 066
UNIDEN	016 021 037 055 056 057
ZENITH	024 031 068

Setting up Your PC Software (Based on Windows XP)

The Windows display-settings for a typical computer are shown below. The actual screens on your PC may be different depending upon your particular version of Windows and your particular video card. Even if your actual screens look different, the same, basic set-up information will apply in almost all cases. (If not, contact your computer manufacturer or Samsung Dealer.)



1. First, click on "Control Panel" on the Windows start menu.
2. When the control panel window appears, click on "Appearance and Themes" and a display dialog-box will appear.
3. When the control panel window appears, click on "Display" and a display dialog-box will appear.
4. Navigate to the "Settings" tab on the display dialog-box.
The correct size setting (resolution): Optimum- 1360 X 768
If a vertical-frequency option exists on your display settings dialog box, the correct value is "60" or "60 Hz". Otherwise, just click "OK" and exit the dialog box.

Display Modes

Both screen position and size will vary depending on the type of PC monitor and its resolution. The resolutions in the table are recommended. (All resolutions between the supported limits are supported)

LA32R81BD, LA40R81BD

> D-Sub Input

Mode	Resolution	Horizontal Frequency (kHz)	Vertical Frequency (Hz)	Pixel Clock Frequency (MHz)	Sync Polarity (H/V)
IBM	640 x 350	31.469	70.086	25.175	+ / -
	720 x 400	31.469	70.087	28.322	- / +
	640 x 480	31.469	59.940	25.175	- / -
VESA	640 x 480	37.861	72.809	31.500	- / -
	640 x 480	37.500	75.000	31.500	- / -
	640 x 480	43.269	85.008	36.000	- / -
	800 x 600	37.879	60.317	40.000	+ / +
	800 x 600	48.077	72.188	50.000	+ / +
	800 x 600	46.875	75.000	49.500	+ / +
	800 x 600	53.674	85.061	56.250	+ / +
	1024 x 768	48.363	60.004	65.000	- / -
	1024 x 768	56.476	70.069	75.000	- / -
	1024 x 768	68.677	84.997	94.500	+ / +
	1024 x 768	60.023	75.029	78.750	+ / +
	1360 x 768	47.712	60.015	85.800	+ / +
1152 x 864	53.783	59.959	81.750	- / +	
VESA GTF	640 x 480	35.000	70.000	28.560	- / +
	800 x 600	43.750	70.000	45.500	- / +
	1024 x 768	57.672	72.000	78.434	- / -

> HDMI/DVI Input

Mode	Resolution	Horizontal Frequency (kHz)	Vertical Frequency (Hz)	Pixel Clock Frequency (MHz)	Sync Polarity (H/V)
IBM	640 x 350	31.469	70.086	25.175	+ / -
	720 x 400	31.469	70.087	28.322	- / +
	640 x 480	31.469	59.940	25.175	- / -
VESA	800 x 600	37.879	60.317	40.000	+ / +
	1024 x 768	48.364	60.000	65.000	- / -
	1360 x 768	47.712	60.015	85.800	+ / +

LA40M81BD, LA46M81BD, LA52M81BD

➤ D-Sub Input

Mode	Resolution	Horizontal Frequency (kHz)	Vertical Frequency (Hz)	Pixel Clock Frequency (MHz)	Sync Polarity (H/V)
IBM	640 x 350	31.469	70.086	25.175	+ / -
	640 x 480	31.469	59.940	25.175	- / -
	720 x 400	31.469	70.087	28.322	- / +
VESA	640 x 480	35.000	70.000	28.560	- / +
	640 x 480	37.861	72.809	31.500	- / -
	640 x 480	37.500	75.000	31.500	- / -
	800 x 600	35.156	56.250	36.000	+ / +
	800 x 600	43.750	70.000	45.500	- / +
	800 x 600	37.879	60.317	40.000	+ / +
	800 x 600	48.077	72.188	50.000	+ / +
	800 x 600	46.875	75.000	49.500	+ / +
	1024 x 768	57.672	72.000	78.434	- / -
	1024 x 768	48.364	60.000	65.000	- / -
	1024 x 768	56.476	70.069	75.000	- / -
	1024 x 768	60.023	75.029	78.750	+ / +
	1152 x 864	67.500	75.000	108.000	+ / +
	1280 x 960	60.000	60.000	108.000	+ / +
	1280 x 1024	63.981	60.020	108.000	+ / +
	1280 x 1024	74.620	70.000	128.943	- / -
	1280 x 1024	76.824	72.000	132.752	- / -
1280 x 1024	79.976	75.025	135.000	+ / +	
1600 x 1200	75.000	60.000	162.000	+ / +	
1920 x 1080	66.587	59.934	138.500	+ / -	

➤ HDMI/DVI Input

Mode	Resolution	Horizontal Frequency (kHz)	Vertical Frequency (Hz)	Pixel Clock Frequency (MHz)	Sync Polarity (H/V)
IBM	640 x 350	31.469	70.086	25.175	+ / -
	640 x 480	31.469	59.940	25.175	- / -
	720 x 400	31.469	70.087	28.322	- / +
VESA	800 x 600	37.879	60.317	40.000	+ / +
	1024 x 768	48.364	60.000	65.000	- / -
	1280 x 1024	63.981	60.020	108.000	+ / +
	1920 x 1080	66.587	59.934	138.500	+ / -

- The interlace mode is not supported.
- The set might operate abnormally if a non-standard video format is selected.
- DVI does not support PC function.
- Separate and Composite modes are supported. SOG is not supported.

Setting the PC

Coarse and Fine Tuning of the Image (Image Lock):

The purpose of picture quality adjustment is to remove or reduce picture noise.

If the noise is not removed by Fine-tuning alone, then adjust the frequency as best as possible (coarse) and Fine-tune again. After the noise has been reduced, re-adjust the picture so that it is aligned on the center of screen.

1. Preset: Press the **SOURCE** button to select PC mode.
2. Press the **MENU** button to display the menu. Press the **▲** or **▼** button to select "Setup", then press the **ENTER/OK** button.
3. Press the **▲** or **▼** button to select "PC", then press the **ENTER/OK** button.
4. Press the **ENTER/OK** button to select "Image Lock".
5. Press the **▲** or **▼** button to select "Coarse" or "Fine", then press the **ENTER/OK** button.
6. Press the **◀** or **▶** button to adjust the screen quality. Press the **ENTER/OK** button.
7. Press the **EXIT** button to exit.

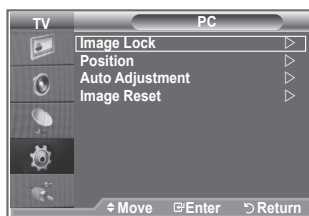

Changing the Image Position:

Adjust the PC's screen positioning if it does not fit the TV screen.

1. Follow the "Coarse and Fine Tuning of the Image (Image Lock)" instructions number 1 to 3.
2. Press the **▲** or **▼** button to select "Position", then press the **ENTER/OK** button.
3. Press the **▲** or **▼** button to adjusting the Vertical-Position. Press the **◀** or **▶** button to adjust the Horizontal-Position. Press the **ENTER/OK** button.
4. Press the **EXIT** button to exit.

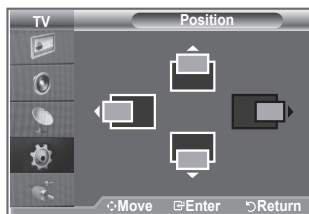

Adjusting the PC Screen Automatically (Auto Adjustment):

Auto adjustment allows the PC screen of set to self-adjust to the incoming PC video signal. The values of fine, coarse and position are adjusted automatically.

1. Follow the "Coarse and Fine Tuning of the Image (Image Lock)" instructions number 1 to 3.
2. Press the **▲** or **▼** button to select "Auto Adjustment", then press the **ENTER/OK** button.
3. Press the **EXIT** button to exit.

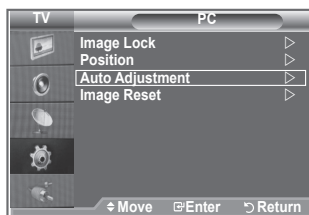

Initializing the Image Settings (Image Reset):

You can replace all image settings with the factory default values.

1. Follow the "Coarse and Fine Tuning of the Image (Image Lock)" instructions number 1 to 3.
2. Press the **▲** or **▼** button to select "Image Reset", then press the **ENTER/OK** button.
3. Press the **EXIT** button to exit.

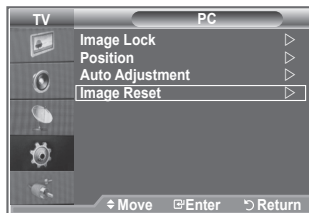

Wall-Mount Adjustment (LA40R81BD, LA40M81BD, LA46M81BD, LA52M81BD) (Sold separately)

Once the wall mount is installed, the position of your TV can be easily adjustable.

1. Press the **MENU** button to display the menu.
Press the **▲** or **▼** button to select "Setup", then press the **ENTER/OK** button.
 2. Press the **▲** or **▼** buttons to select "Wall-Mount Adjustment", then press the **ENTER/OK** button.
 3. Adjust to the desired position using the **▲, ▼, ◀, ▶** buttons.
 4. Press the **EXIT** button to exit.
 - If you press an arrow button when no OSD is displayed on the TV screen, the Adjustment screen appears.
 - When you turn the power off, your TV moves to the initial installation position.
When you turn the power on, your TV moves to the last remembered position you adjusted.
- Light Effect is only for LA40R8

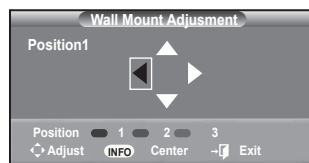
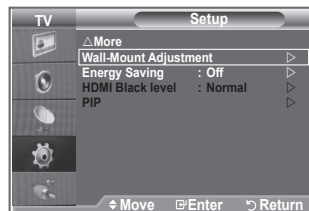

Using the Remote Control Buttons

Button	Operations	
	Wall-mount angle adjustment	Tilt Up, Tilt Down, Move right, Move left
	Reset	Moves to the initial installation position
	Remembering the position and moving to the remembered position	Remembers 3 positions with the Red, Green and Yellow buttons. Moves to the remembered position using these 3 color buttons.

- For installation, refer to the Installation Manual provided.
- For product installation and the installation and moving of the wall mount, make sure to consult a specialized installation company.
- This installation manual is to be used when attaching the wall mount to a wall.
When attaching to other building materials, please contact your nearest dealer

What is Anynet+?

Anynet+ is an AV network system that enables an easy-to-use AV interface for users by controlling all connected AV devices through the Anynet+ menu when Samsung Electronics AV devices are connected.

Connecting Anynet+ Devices

The Anynet+ system supports AV devices supporting Anynet+ only. Check if there is an Anynet+ mark on the AV device to be connected to the TV.

To directly connect to TV

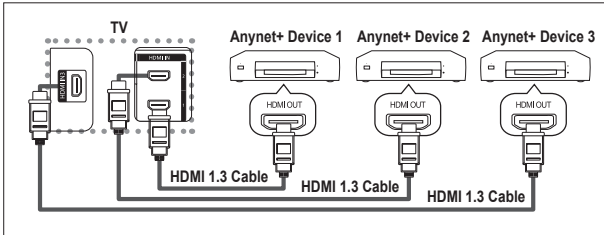

Connect the [HDMI 1], [HDMI 2] or [HDMI 3] jack on the TV and the HDMI OUT jack of the corresponding Anynet+ device using the HDMI cable.

To connect to Home Theater

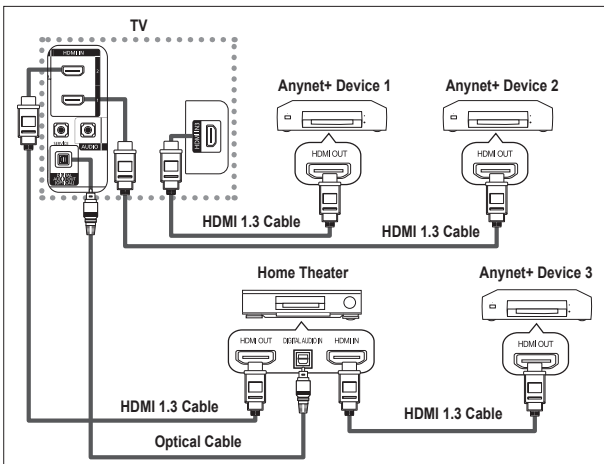

1. Connect the [HDMI 1], [HDMI 2] or [HDMI 3] jack on the TV and the HDMI OUT jack of the corresponding Anynet+ device using the HDMI cable.
2. Connect the HDMI IN jack of the home theater and the HDMI OUT jack of the corresponding Anynet+ device using the HDMI cable.

- Connect only the optical cable between [Digital Audio Out (Optical)] on your TV and Digital Audio Input on the receiver.
- Connect only one receiver.
- You can listen to 5.1 channel sound through the home theater's speakers. Otherwise, you can only listen to 2 channel stereo sound in other cases. Make sure to connect the Digital Audio IN (Optical) of the home theater and the TV correctly to listen to TV sound through the home theater. However, you cannot listen to sound from the BD recorder that is sent to the home theater via the TV in 5.1 channel sound because the TV outputs only 2 channel stereo sound. Please see the manual for the home theater.
- You can connect an Anynet+ device using the HDMI 1.3 cable. Some HDMI cables may not support Anynet+ functions.
- Anynet+ works when the AV device supporting Anynet+ is in the Standby or On status.
- Anynet+ supports up to 8 AV devices in total.

Setting Up Anynet+

The following settings are to use Anynet+ functions.

Using the Anynet+ Function

1. Press the **Anynet+** button.
Press the **▲** or **▼** button to select **Setup**, then press the **ENTER/OK** button.
2. Press the **ENTER/OK** button to select **Anynet+ (HDMI-CEC)**, then press the **ENTER/OK** button.
3. Press the **▲** or **▼** button to select **On**, then press the **ENTER/OK** button.
 - The Anynet+ (HDMI-CEC) function is enabled.
 - If you select **Off**, Anynet+ (HDMI-CEC) is disabled.
 - When the Anynet+ (HDMI-CEC) function is disabled, all the Anynet+ related operations are deactivated.

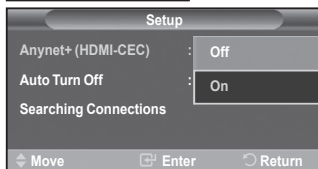

Turning an Anynet+ Device Off Automatically when the TV is Turned Off

1. Press the **▲** or **▼** button to select **Auto Turn Off**, then press the **ENTER/OK** button.
 2. Press the **▲** or **▼** button to select **On**, then press the **ENTER/OK** button.
 - The Auto turn off function is enabled.
 - If you select **Off**, the Auto turn off function is canceled. Press the **EXIT** button to exit.
- The Select Device setting of the TV remote control is to be set to TV to use the Anynet+ function.
- If you set Auto Turn Off to On, connected external devices are also turned off when the TV is turned off. However, if the device is recording, it may not be turned off.

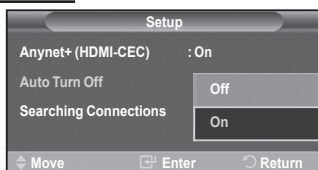

Scanning and Switching between Anynet+ Devices

1. Press the **Anynet+** button.
2. Press the **▲** or **▼** button to select **Select Device**, then press the **ENTER/OK** button.
3. Press the **▲** or **▼** button to select to a particular device and press the **ENTER/OK** button. It is switched to the selected device.
4. If you cannot find a device you want, press the **▲** or **▼** button to select **Searching Connections**, then press the **ENTER/OK** button.

The message **Configuring Anynet+ connection...** is displayed. When searching devices completes, the connected devices are listed in the Anynet+ menu.

- Switching to the selected devices may take up to 2 minutes. You cannot cancel the operation during the switching operation.
- The time required to scan for devices is determined by the number of connected devices.
- When the device scan is complete, the number of found devices is not displayed.
- Although the TV automatically scans devices when it is turned on using the **POWER** button, devices connected when the TV is on or under a specific circumstance are not displayed in the device list. Therefore select **Searching Connections** menu to search devices.
- If you have selected external input mode by pressing the **SOURCE** button, you cannot use the Anynet+ function. Make sure to switch to an Anynet+ device by using the **Anynet+** button.

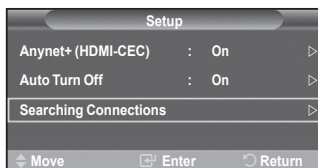

Anynet+ Menu

The Anynet+ menu changes depending on the type and status of the Anynet+ devices connected to the TV.

Anynet+ Menu	Description
View TV	Switches from Anynet+ to TV broadcast mode.
Select Device	Your TV connects to the corresponding device.
Record	Starts a recording. (This menu works only for a device supporting recording.)
Menu on Device	Shows the menu of the connected device. Example. When a DVD Recorder is connected, the DVD Recorder's title menu appears.
Device Operation	Shows the play control menu of the connected device. Example. When a DVD Recorder is connected, the play control menu of the DVD Recorder appears.
Receiver	Sound is output through the receiver.
Setup	You can set the environment for using Anynet+.

TV Remote Control Buttons Available in Anynet+ Mode

Device Type	Operating Status	Available Buttons
Anynet+ Device	After switching to the device, when the menu of the corresponding device is displayed on the screen.	Numeric buttons ▲/▼/◀/▶/ENTER buttons Color buttons EXIT button
	After switching to the device, while playing a file	◀◀(Backward search) ▶▶(Forward search) ■(Stop) ▶ (Play/Pause)
Device with built-in Tuner	After switching to the device, when you are watching a TV program	CH ▲/▼ button
Audio Device	When Receiver is activated	VOL +/- button MUTE button
Anyview2	When watching TV	▶ (Play/Pause)

- The Anynet+ function only works when the remote control is set to TV.
- The **REC** button works only while in the recordable state.
- You cannot control Anynet+ devices using the buttons on the side of the TV. You can control Anynet+ devices only using the TV remote control.
- The TV remote control may not work under certain conditions. In this case, re-select the Anynet+ device.
- The Anynet+ functions don't operate for the products from other manufacturers.
- In Anynet+ mode, the color buttons may not work properly.
- The ◀◀, ▶▶ operations may differ depending on the device.

Recording

You can make a recording of a TV program using a recorder.

Press the **REC** button.

Recording begins. (Only when the Anynet+ enabled recording device is connected.)

- The current TV program is recorded in the Watching TV status. If you are watching video from another device, the video from the device is recorded.
- You can also record the source streams by selecting **Record** after pressing the Anynet+ button.
- Before recording, check whether the antenna jack is properly connected to the recording device. For the antenna connection to the recording device, refer to its user manual.

Listening through a Receiver

You can listen to sound through a receiver instead of the TV speaker.

1. Press the **Anynet+** button.
Press the **▲** or **▼** button to select **Receiver**, then press the **ENTER/OK** button.
2. Press the **◀** or **▶** button to select to **On**, then press the **ENTER/OK** button.
Now you can listen to sound through the receiver.
3. Press the **EXIT** button to exit.
 - When the receiver is set to On, you can listen to the TV sound through the 2-channel receiver.
 - If the receiver is exclusively for a home theater only (supporting audio only), it may not appear in the device list.
 - Only when you have connected the optical jack of the TV and the receiver properly, does Receiver work.
 - In case of a content with copyright problem, listening through the receiver may not properly operate.
 - When listening through the receiver, there are restrictions for using the PIP and audio-related menu.



Check Points before Requesting Service

Symptom	Solution
Anynet+ does not work.	<ul style="list-style-type: none"> ■ Check if the device is an Anynet+ device. The Anynet+ system supports Anynet+ devices only. ■ Connect only one receiver. ■ Check if the Anynet+ device power cord is properly connected. ■ Check the Anynet+ device's Video/Audio/HDMI 1.3 cable connections. ■ Check whether Anynet+ (HDMI-CEC) is set to On in the Anynet+ setup menu. ■ Check whether the TV remote control is in TV mode. ■ Check whether it is Anynet+ exclusive remote control. ■ Anynet+ doesn't work at a certain condition. (Searching channels) ■ When connecting or removing the HDMI 1.3 cable, please make sure to search devices again or restart your TV. ■ Check if the Anynet+ Function of Anynet+ device is set on.
I want to start Anynet+.	<ul style="list-style-type: none"> ■ Check if the Anynet+ device is properly connected to the TV and check if the Anynet+ (HDMI-CEC) is set to On in the Anynet+ Setup menu. ■ Press the TV button on the TV remote control to switch to TV. Then press the Anynet+ button to show the Anynet+ menu and select a menu you want.
I want to exit Anynet+.	<ul style="list-style-type: none"> ■ Select View TV in Anynet+ menu. ■ Press the SOURCE button on the TV remote control and select a device other than Anynet+ devices. ■ Press any of CH, CH LIST, PRE-CH, and such to change to the TV mode. (Note that the channel button operates only when a tuner-embedded Anynet+ device is not connected.)
The Connecting to Anynet+ device... message appears on the screen.	<ul style="list-style-type: none"> ■ You cannot use the remote control when you are configuring Anynet+ or switching to a view mode. ■ Use the remote control when the Anynet+ setting or switching to view mode is complete.
The Anynet+ device does not play.	You cannot use the play function when an auto channel scan is in progress.
The connected device is not displayed.	<ul style="list-style-type: none"> ■ Check whether or not the device supports Anynet+ functions. ■ Check whether or not the HDMI 1.3 cable is properly connected. ■ Check whether Anynet+ (HDMI-CEC) is set to On in the Anynet+ setup menu. ■ Search Anynet+ devices again. ■ You can connect an Anynet+ device using the HDMI 1.3 cable only. Some HDMI cables may not support Anynet+ functions.
The TV program cannot be recorded.	Check whether the antenna jack on the recording device is properly connected.
The TV sound is not output through the receiver.	Connect the optical cable between TV and the receiver.



Using the Anti-Theft Kensington Lock

The Kensington lock is a device used to physically fix the system when using it in a public place. The locking device has to be purchased separately. The appearance and locking method may differ from the illustration depending on the manufacturer. Please refer to the manual provided with the Kensington lock for proper use.

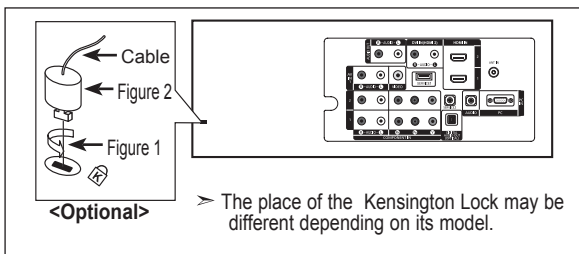
1. Insert the locking device into the Kensington slot on the LCD TV (Figure 1), and turn it in the locking direction (Figure 2).
2. Connect the Kensington lock cable to a desk or a heavy stationary object.
3. Fix the Kensington lock to a desk or a heavy stationary object.



Troubleshooting: Before Contacting Service Personnel

No sound or picture	<ul style="list-style-type: none"> ♦ Check that the mains lead has been connected to a wall socket. ♦ Check that you have pressed the POWER  buttons on the front of the set. ♦ Check the picture contrast and brightness settings. ♦ Check the volume.
Normal picture but no sound	<ul style="list-style-type: none"> ♦ Check the volume. ♦ Check whether the MUTE  button has been pressed on the remote control. ♦ Check if "Internal Mute" is off
No picture or black and white picture	<ul style="list-style-type: none"> ♦ Adjust the colour settings. ♦ Check that the broadcast system selected is correct.
Sound and picture interference	<ul style="list-style-type: none"> ♦ Try to identify the electrical appliance that is affecting the set and move it further away. ♦ Plug your set into a different mains socket.
Blurred or snowy picture, distorted sound	<ul style="list-style-type: none"> ♦ Check the direction, location and connections of your aerial. This interference is often due to the use of an indoor aerial.
Remote control malfunctions	<ul style="list-style-type: none"> ♦ Replace the remote control batteries. ♦ Clean the upper edge of the remote control (transmission window). ♦ Check the battery terminals.
"Check signal cable." message is displayed.	<ul style="list-style-type: none"> ♦ Check that the signal cable is firmly connected to the PC or video sources. ♦ Check that the PC or video sources are turned on.
On PC mode, "Not Supported Mode." message is displayed.	<ul style="list-style-type: none"> ♦ Check the maximum resolution and the frequency of the video adaptor. ♦ Compare these values with the data in the Display Modes.

The TFT LCD panel uses a panel consisting of sub pixels (3,133,440) which require sophisticated technology to produce. However, there may be few bright or dark pixels on the screen. These pixels will have no impact on the performance of the product.

Technical and Environmental Specifications

Model Name	LA32R81BD	LA40R81BD
Screen Size (Diagonal)	32 inch	40 inch
Power Consumption	150 W	190 W
PC Resolution	1360 x 768 @ 60 Hz	1360 x 768 @ 60 Hz
Sound Output	10 W X 2	10 W X 2
Dimension (WxDxH) Body With stand	800 X 79 X 541 mm 800 X 252 X 578 mm	992 X 87 X 655 mm 992 X 300 X 702 mm
Weight With stand	13.8 kg	21.7 kg
Environmental Considerations Operating Temperature Operating Humidity Storage Temperature Storage Humidity	10 °C to 40 °C (50 °F to 104 °F) 10 % to 80 %, non-condensing -20 °C to 45 °C (-4 °F to 113 °F) 5 % to 95 %, non-condensing	10 °C to 40 °C (50 °F to 104 °F) 10 % to 80 %, non-condensing -20 °C to 45 °C (-4 °F to 113 °F) 5 % to 95 %, non-condensing

Model Name	LA40M81BD	LA46M81BD	LA52M81BD
Screen Size (Diagonal)	40 inch	46 inch	52 inch
Power Consumption	240 W	260 W	280 W
PC Resolution	1920 X 1080 @ 60 Hz	1920 X 1080 @ 60 Hz	1920 X 1080 @ 60 Hz
Sound Output	10 W X 2	10 W X 2	10 W X 2
Dimension (WxDxH) Body With stand	971 x 87 x 628 mm 971 x 300 x 687 mm	1106 x 104x 706 mm 1106 x 326 x 768 mm	1255 x 111 x 799 mm 1255 x 326 x 860 mm
Weight With stand	20.9 kg	29.6 kg	36.4 kg
Environmental Considerations Operating Temperature Operating Humidity Storage Temperature Storage Humidity	10 °C to 40 °C (50 °F to 104 °F) 10 % to 80 %, non-condensing -20 °C to 45 °C (-4 °F to 113 °F) 5 % to 95 %, non-condensing	10 °C to 40 °C (50 °F to 104 °F) 10 % to 80 %, non-condensing -20 °C to 45 °C (-4 °F to 113 °F) 5 % to 95 %, non-condensing	10 °C to 40 °C (50 °F to 104 °F) 10 % to 80 %, non-condensing -20 °C to 45 °C (-4 °F to 113 °F) 5 % to 95 %, non-condensing

Stand Swivel (Left / Right)

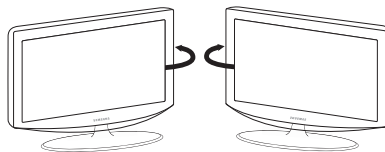

-20° ~ 20°

- > Design and specifications are subject to change without prior notice.
- > This device is a Class B digital apparatus.
- > For the power supply, refer to the label attached to the product.

***This page is intentionally
left blank.***