

---

## - AFTER SALES SERVICE

---

- Do not hesitate to contact your retailer or service agent if a change in the performance of your product indicates that a faulty condition may be present.



**Correct Disposal of This Product  
(Waste Electrical & Electronic Equipment)**  
(Applicable in the European Union and other European countries with separate collection systems)

 This marking shown on the product or its literature, indicates that it should not be disposed with other household wastes at the end of its working life. To prevent possible harm to the environment or human health from uncontrolled waste disposal, please separate this from other types of wastes and recycle it responsibly to promote the sustainable reuse of material resources. Household users should contact either the retailer where they purchased this product, or their local government office, for details of where and how they can take this item for environmentally safe recycling. Business users should contact their supplier and check the terms and conditions of the purchase contract. This product should not be mixed with other commercial wastes for disposal.

BN68-00969A-00

LCD TV  
LW15M23C/LW17M24C/LW17M24CU/LW20M21C/LW20M21CU/LW20M22C



# LCD TV

LW15M23C  
LW17M24C  
LW17M24CU  
LW20M21C  
LW20M21CU  
LW20M22C

## Owner's Instructions

Before operating the unit,  
please read this manual thoroughly,  
and retain it for future reference.

**ON-SCREEN MENUS  
PC DISPLAY  
PICTURE IN PICTURE (PIP)  
TELETEXT**

This device is a Class B digital apparatus.

Register your product at  
[www.samsung.com/global/register](http://www.samsung.com/global/register)



**SAMSUNG**

# LCD TV

LW15M23C

LW17M24C

LW17M24CU

LW20M21C

LW20M21CU

LW20M22C

## Owner's Instructions

Before operating the unit,  
please read this manual thoroughly,  
and retain it for future reference.

**ON-SCREEN MENUS  
PC DISPLAY  
TELETEXT**

Register your product at  
[www.samsung.com/global/register](http://www.samsung.com/global/register)

## Precautions When Displaying a Still Image

A still image may cause permanent damage to the TV screen.

- Digital Ready TV: When you select the regular screen (4:3) mode to watch an SD-grade digital broadcast (and the set-top box output is 480p).



- Digital Ready TV: When you select the wide screen (16:9) mode to watch an SD-grade digital broadcast (and the set-top box output is 1080i).



- Digital Ready TV: When the TV receives HD-grade signals (and the set-top box output is 1080i).

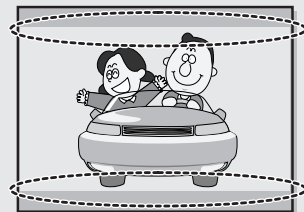

Although digital broadcasting must be in the wide screen (16:9) HD format, broadcasters sometimes show programs made originally in the regular screen format (4:3) by converting the signals into digital form, in which case the left and right side edges of the screen are cropped.

---

*Note : If the borders at the left, right and the center of the screen remain fixed for an extended period of time, the amount of light transmission will also remain varied and as a result the borders may leave traces.*

---

Do not leave the screen in pause mode for extended periods of time as you may experience the same problem with products by other manufacturers.

When you watch a digital HD-grade broadcast on a regular (4:3) TV with the screen size "16:9" or "Panorama" selected, you will be able to watch the program but the top and bottom edges of the screen will be cropped.

---

*Note : If the borders at the top, bottom and the center of the screen remain fixed for an extended period of time, the amount of light transmission will also remain varied and as a result the borders may leave traces.*

---

Do not leave the screen in pause mode for extended periods of time as you may experience the same problem with products by other manufacturers.

- Integrated Digital TV (Wide-screen): When the TV receives SD-grade (regular) broadcasting signals (receives 480p regular signals).
- Digital Ready TV (wide-screen): digital TV: When the TV receives SD-grade (regular) broadcasting signals (with a set-top box).
- When you watch an analogue (regular) broadcast on a wide-screen TV (with the 4:3 screen mode selected).

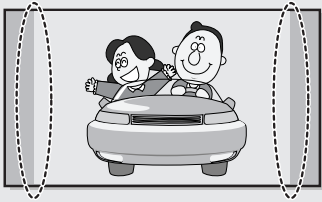

Although digital broadcasting must be in the wide screen (16:9) HD format, broadcasters sometimes show programs made originally in the regular screen format (4:3) by converting the signals into digital form, in which case the left and right side edges of the screen are cropped.

---

*Note : If the borders at the left, right and the center of the screen remain fixed for an extended period of time, the amount of light transmission will also remain varied and as a result the borders may leave traces.*

---

Do not leave the screen in pause mode for extended periods of time as you may experience the same problem with products by other manufacturers.

- When you watch a DVD, CD or a video in wide screen (21:9) format on a wide-screen (16:9) TV.
- When you connect a computer or a game console to the TV and select the 4:3 screen mode.

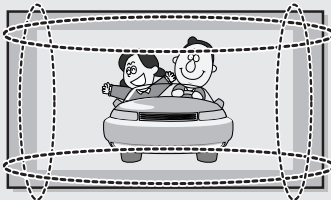

If you connect a DVD player, computer or a game console to the wide-screen TV and watch a movie or play a game in regular (4:3) or wide (21:9) screen mode, the left and right side edges, or the top and bottom edges of the screen will be cropped.

---

*Note : If the borders at the left, right and the center of the screen remain fixed for an extended period of time, the amount of light transmission will also remain varied and as a result the borders may leave traces.*

---

Do not leave the screen in pause mode for extended periods of time as you may experience the same problem with products by other manufacturers.

# Contents

---

◆ <b>CONNECTING AND PREPARING YOUR TV</b>	
■ Viewing the Control Panel.....	4
■ Viewing the Connection Panel.....	5
– Connecting an Aerial or Cable Television Network.....	6
– Connecting a Set-Top Box, VCR or DVD.....	6
– Connecting a Computer.....	6
– Connecting External A/V Devices.....	7
– Connecting Headphones.....	7
– Kensington Slot.....	7
■ Viewing Pictures From External Sources.....	8
■ Inserting the Batteries in the Remote Control.....	9
■ Viewing the Remote Control (All Functions Except Teletext).....	10
■ Viewing the Remote Control (Teletext Functions).....	11
■ Switching On and Off.....	12
■ Placing in Standby Mode.....	12
■ Becoming Familiar with the Remote Control.....	13
■ Plug & Play.....	14
■ Selecting TV Mode or an Input Source.....	16
■ Editing an Input Source Name.....	17
■ Choosing Your Language.....	18
◆ <b>SETTING THE CHANNELS</b>	
■ Storing Channels Automatically.....	19
■ Storing Channels Manually.....	20
■ Editing the Channels.....	22
■ Sorting the Stored Channels.....	23
■ Giving Channels Names.....	24
◆ <b>SETTING THE PICTURE</b>	
■ Changing the Picture Standard.....	25
■ Adjusting the Custom Picture.....	26
■ Adjusting the Screen Background Colour.....	27
◆ <b>SETTING THE SOUND</b>	
■ Changing the Sound Standard.....	28
■ Selecting Auto Volume Control.....	29

# Contents

◆ <b>SETTING THE TIME</b>	
■ Setting the Clock .....	30
■ Switching Off Automatically .....	31
■ Switching the Television On and Off Automatically .....	32
◆ <b>USING THE VARIOUS FUNCTIONS</b>	
■ Setting the Blue Screen Mode .....	33
■ Displaying Information .....	33
◆ <b>USING THE TELETEXT FEATURE</b>	
■ Teletext Feature .....	34
■ Displaying the Teletext Information .....	35
■ Selecting a Page by Number .....	36
■ Using FLOF to Select a Page .....	37
■ Storing Teletext Pages .....	37
◆ <b>USING THE PC FUNCTIONS</b>	
■ Setting Up Your PC Software .....	38
■ Coarse and Fine Tuning of the Image .....	39
■ Changing the Image Position .....	40
■ Initializing the Image Settings .....	41
■ Adjusting the PC Screen Automatically .....	42
■ Picture Mode .....	43
■ Adjusting the Custom Picture .....	43
■ Adjusting the Screen Background Colour .....	44
■ Customizing the Colour .....	45
<b>RECOMMENDATIONS FOR USE</b>	
■ Troubleshooting: Before Contacting Service Personnel .....	46
■ Power Saver .....	47
■ Technical and Environmental Specifications .....	48
■ Display Modes .....	49
■ Retractable Stand .....	50
■ Using Your TV in Another Country .....	50
■ Using the Anti-Theft Kensington Lock .....	51
■ Installing VESA compliant mounting devices .....	51
■ Installing the Wall Mount Kit (LW15M23C/LW17M24C/LW17M24CU) .....	52
■ Installing the Wall Mount Kit (LW20M21C/LW20M21CU/LW20M22C) .....	54

## Symbols



Press



Important



Note

## Viewing the Control Panel

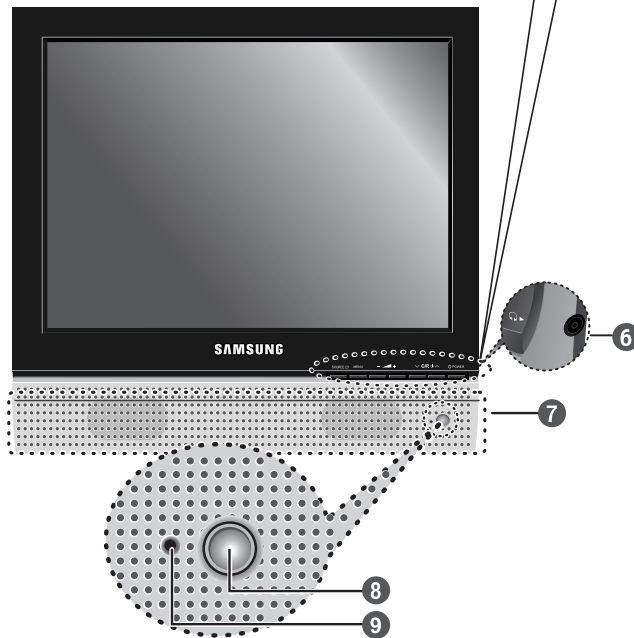
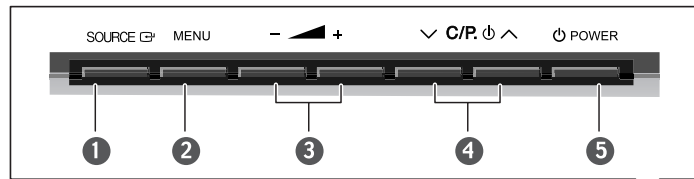

### 1 SOURCE

Displays a menu of all of the available input sources (TV - AV1 - AV2 - S-Video - PC).

- ▶ You can also use the **SOURCE** () button on the TV's control panel to make selections.

### 2 MENU

Press to see an on-screen menu of your TV's features.

### 3 - +

Moves the selector left or right on the OSD.  
Decreases or increases the level of audio volume and the values of the selected function.

### 4

Moves the selector down or up on the OSD.  
Decreases or increases the channel number.

### 5 POWER

Turns ON/OFF your set.

### 6 HEADPHONE

### 7 SPEAKERS

### 8 REMOTE CONTROL SENSOR

Aims the remote control towards this spot on the TV.

### 9 POWER INDICATOR

Lights up when you turn the power off.  
(Red light shows in stand-by mode, Red shows when you turn the power on, and light is off after the power is on. Green shows when you set Timer on or off.)

## Viewing the Connection Panel

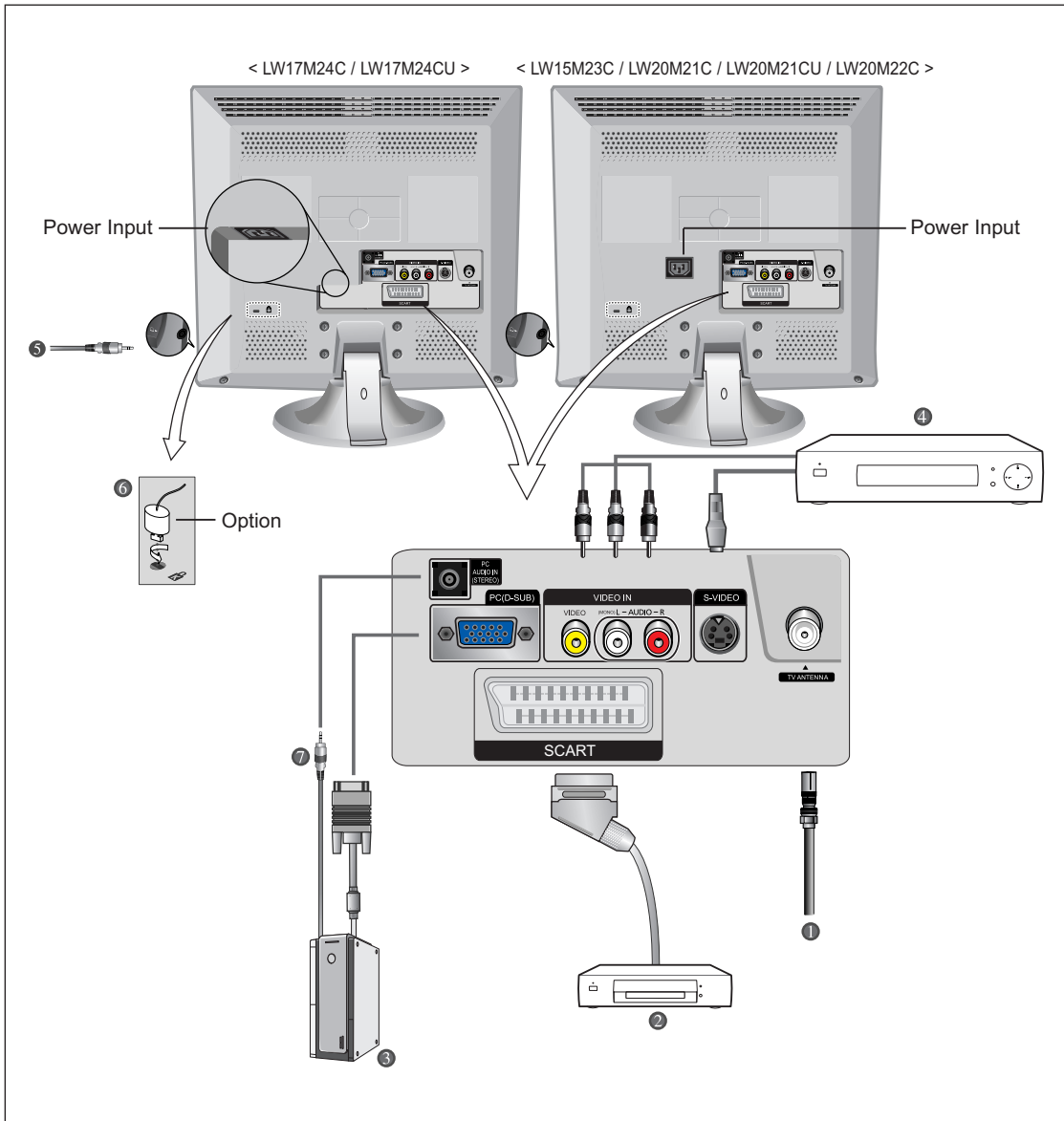

Whenever you connect an audio or video system to your set, ensure that all elements are switched off. Refer to the documentation supplied with your equipment for detailed connection instructions and associated safety precautions.



## Viewing the Connection Panel

### ❶ Connecting an Aerial or Cable Television Network (depending on the model)

To view television channels correctly, a signal must be received by the set from one of the following sources:

- An outdoor aerial
- A cable television network
- A satellite network

### ❷ Connecting a Set-Top Box, VCR or DVD

- Connect the VCR, or DVD SCART cable to the SCART connector of the VCR, or DVD.
- If you wish to connect both the Set-Top Box and VCR (or DVD), you should connect the Set-Top Box to the VCR (or DVD) and connect the VCR (or DVD) to your set.

### ❸ Connecting a Computer

- Connect the 15 Pin D-SUB connector to the PC video connector.
- Connect the stereo audio cable to the "PC AUDIO IN (STEREO)" jack ( ⑦ ) on the rear of your set and the other end to the "Audio Out" jack of the sound card on your computer.

➤ 15 Pin D-SUB connector

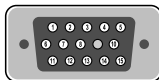

Pin	Separate H/V	Composite H/V
1	Red (R)	Red (R)
2	Green (G)	Green (G)
3	Blue (B)	Blue (B)
4	Grounding	Grounding
5	Grounding (DDC return)	Grounding (DDC return)
6	Grounding - Red (R)	Grounding - Red (R)
7	Grounding - Green (G)	Grounding - Green (G)
8	Grounding - Blue (B)	Grounding - Blue (B)
9	No connection	No connection
10	Grounding - Sync. / Self test	Grounding - Sync. / Self test
11	Grounding	Grounding
12	DDC - SDA (Data)	DDC - SDA (Data)
13	Horizontal Sync.	Horizontal/Vertical Sync.
14	Vertical Sync.	Not used
15	DDC - SCL (Clock)	DDC - SCL (Clock)

## Viewing the Connection Panel

### ④ **Connecting External A/V Devices**

- Connect RCA or S-VIDEO cables to an appropriate external A/V device such as a VCR, DVD or Camcorder.
- Connect RCA audio cables to “(MONO)L-AUDIO-R” on the rear of your set and the other ends to corresponding audio out connectors on the A/V device.

### ⑤ **Connecting Headphones**

- Plug a set of headphones into the 3.5mm mini-jack socket on the right-side of the set.  
*While the headphones are connected, the sound from the built-in speakers will be disabled.*

### ⑥ **Kensington Slot**

- This television has been designed to apply a burglarproof lock.(See page 51)

## Viewing Pictures From External Sources



*Once you have connected up your various audio and video systems, you can view the different sources by selecting the appropriate input.*

- 1 Check that all the necessary connections have been made (refer to pages **6** and **7** for further details).
- 2 ♦ Press the **TV** button to choose TV mode.  
♦ Press the **SOURCE** button to choose Video mode.  
The input sources are displayed in the following order:  
AV1 - AV2 - S-Video - PC.

## Inserting the Batteries in the Remote Control

You must insert or replace the batteries in the remote control when you:

- ◆ Purchase your set
- ◆ Find that the remote control is no longer operating correctly

- 1 Remove the cover on the rear of the remote control by pressing the symbol downwards and then pulling firmly to remove it.
  - 2 Install two **AAA** size batteries.
    - ◆ + on the battery against + on the remote control
    - ◆ - on the battery against - on the remote control
  - 3 Replace the cover by aligning it with the base of the remote control and pressing it back into place.
- Do not mix battery types, i.e. alkaline and manganese.

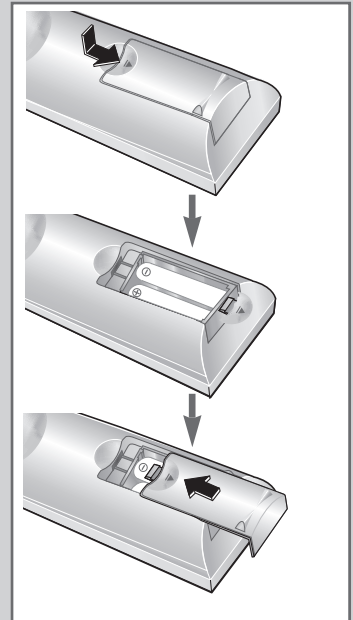

## Viewing the Remote Control (All Functions Except Teletext)

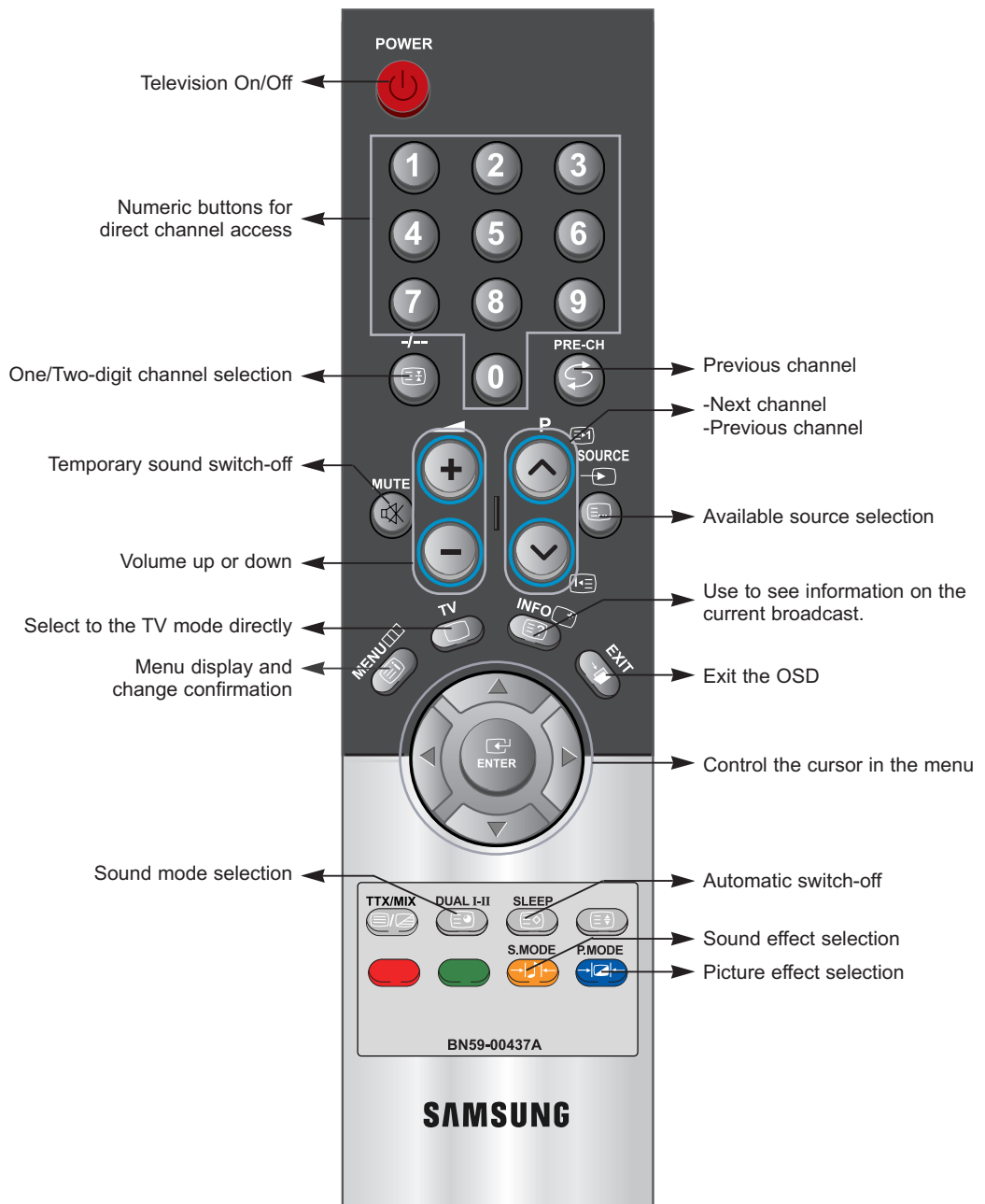

➤ The performance of the remote control may be affected by bright light.

# Viewing the Remote Control (Teletext Functions)

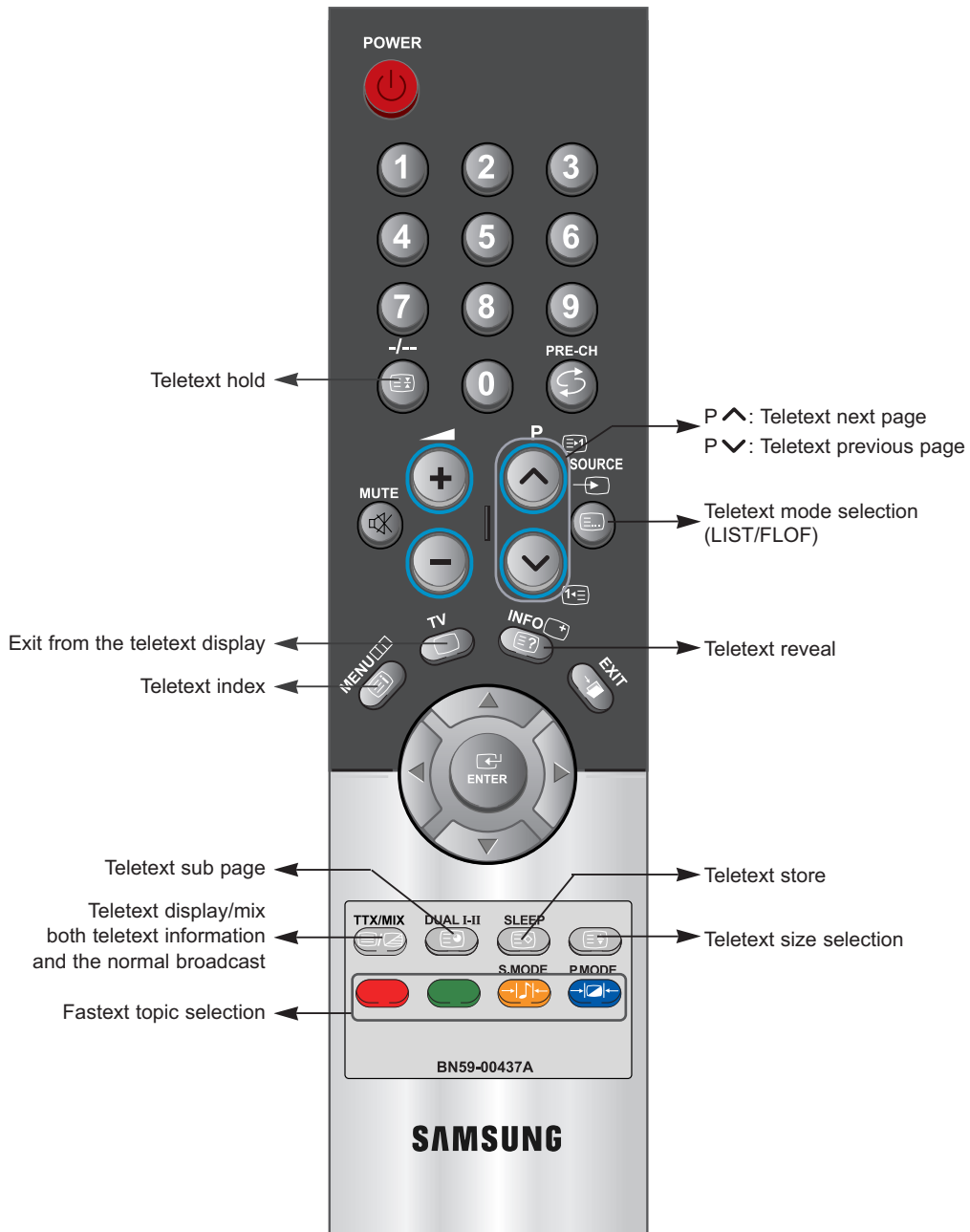

## Switching On and Off

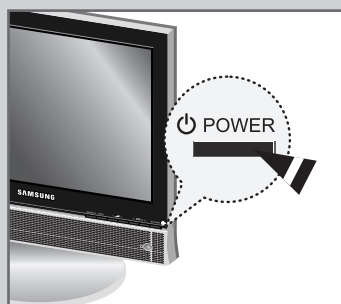

*The mains lead is attached to the rear of your set.*

- 
- 1 Plug the mains lead into an appropriate socket.

Result: When the power cord is plugged in, the LED turns red.

- 
- 2 Press the **POWER** button to switch on.

- 
- 3 To switch off, press the **POWER** button again.
- 

## Placing in Standby Mode



*Your set can be placed in Standby mode in order to reduce the power consumption.*

*The Standby mode can be useful when you wish to interrupt viewing temporarily (during a meal, for example).*

- 
- 1 Press the **POWER** button.

- 
- 2 To switch back on, simply press the **POWER** button again, a numeric button, or channel **▼** or **▲** button.
- 

- Do not leave your set in Standby mode for long periods of time (when you are away on holiday, for example). Turn off by pressing the **POWER** button. It is best to unplug the set from the mains and aerial.

# Becoming Familiar with the Remote Control

The remote control is used mainly to:

- ◆ Change channels and adjust the volume
- ◆ Set up your set using the on-screen menu system

The following table presents the most frequently used buttons and their functions.

Button	Viewing Function	Menu Function
P ▲	Used to display the next stored channel.	-
P ▼	Used to display the previous stored channel.	-
<b>PRE-CH</b> ⊕	Used to switch repeatedly between the last two channels displayed. ( <b>PRE-CH</b> ; Previous Channel)	
⊕ - ⊖	Used to display the corresponding channels.	
-/--	Used to select a channel numbered ten or over. Press this button, and the “-” symbol is displayed. Enter the two-digit channel number.	
▲ +	Used to increase the volume.	-
▼ -	Used to decrease the volume.	-
<b>MUTE</b> ⊗	Used to switch the sound off temporarily. ➤ To turn the sound back on, press this button again, or press the + or - button.	
<b>MENU</b> ☰	Used to display the on-screen menu system.	Used to return to the previous menu or normal viewing.
<b>EXIT</b> →	Used to exit the menu system and return directly to normal viewing.	
⊙	▲▼ Used to move among the menu items. ▶ Used to select a menu item or increase the value of the selected item. ◀ Used to return to the previous menu item or decrease the value of the selected item.	





# Plug & Play

## Plug & Play

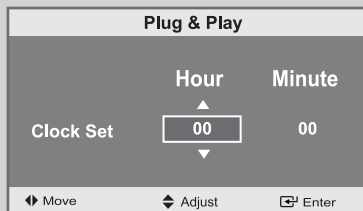
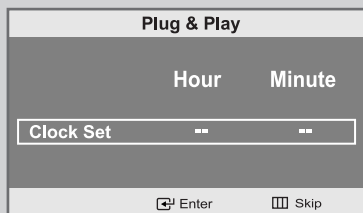

Enjoy your viewing

When the set is initially powered ON, you are automatically presented with a series of basic customer settings.

The following settings are available.

- 1 If the set is in standby mode, press the **POWER** button on the remote control.  
Result: The message **Plug & Play** is displayed. It appears for a little while, and then the **Language** menu is automatically displayed.
- 2 Select the appropriate **Language** by pressing the **▲** or **▼** button.  
➤ The available languages are listed. You can choose one of **12** languages.
- 3 Press the **ENTER** button to confirm your choice.  
Result: The message “**Check antenna input.**” is displayed with **OK** selected.
- 4 Press the **ENTER** button.  
Result: The country menu is displayed:  
**Belgium - Germany - Spain - France - Italy - Netherlands - Switzerland - Sweden - United Kingdom - Eastern Europe - Others**
- 5 Select your **Country** by pressing the **▲** or **▼** button. Press the **ENTER** button.  
Result: The **Auto Store** menu is displayed.
- 6 Press the **ENTER** button.  
Result: The channel search will start and end automatically.  
➤ To stop the search before it has finished, press the **ENTER** button with **Stop** selected.
- 7 Press the **ENTER** button. Select the **Hour** or **Minute** by pressing the **◀** or **▶** button. Set the **Hour** or **Minute** by pressing the **▲** or **▼** button. (Refer to “**Setting the Clock**” on page 30)
- 8 Press the **MENU** button to confirm your setting.  
Result: The message “**Enjoy your viewing**” is displayed, and then the channel which has been stored will be activated.
- 9 Press the **EXIT** button to exit.

# Plug & Play

*If you want to reset this feature...*

- 1 Press the **MENU** button.

Result: The main menu is displayed.

- 2 Press the **▲** or **▼** button to select the **Setup**.

Result: The options available in the **Setup** group are displayed.

- 3 Press the **ENTER**  button.

- 4 Press the **▲** or **▼** button to select the **Plug & Play**.  
Press the **ENTER**  button.

Result: The message **Plug & Play** is displayed.

- 5 For further details on how to set up this feature, refer to the previous page.

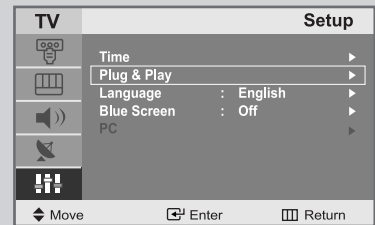

## Selecting TV Mode or an Input Source

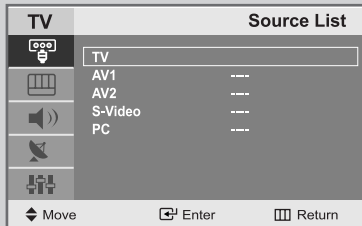

*You can choose TV mode or change to an input source connected to the TV set. Use this button to choose an input source that you would like to watch.*

- 1 Press the **MENU** button.

Result: The main menu is displayed.

- 2 Press the **ENTER** button to select the **Input**.

Result: The options available in the **Input** group are displayed.

- 3 Press the **ENTER** button.

Result: The **Source List** is selected.

- 4 Press the **▲** or **▼** button to move to the input source that you wish to choose.  
Press the **ENTER** button.

Result: The input source changes to the one you have chosen.

## Editing an Input Source Name

Entering the names of the input source devices connected to the input ports on the TV set allows you to find and choose an input source that you would like to watch in a quick and convenient manner.

- 1 Press the **MENU** button.

Result: The main menu is displayed.

- 2 Press the **ENTER** button to select the **Input**.

Result: The options available in the **Input** group are displayed.

- 3 Press the **▲** or **▼** button to select the **Edit Name**.  
Press the **ENTER** button.

- 4 Press the **▲** or **▼** button to move to the input source that you wish to edit.  
Press the **ENTER** button.

Result: The following options are available

- 5 Select the required device by pressing the **▲** or **▼** repeatedly.

Result: The following options are available:

---- - **VCR - DVD - Cable STB - HD STB - Satellite STB - AV Receiver - DVD Receiver - Game - Camcorder - DVD Combo - DHR - PC.**

- 6 When you are satisfied with your choice, press the **EXIT** button to return to normal viewing.

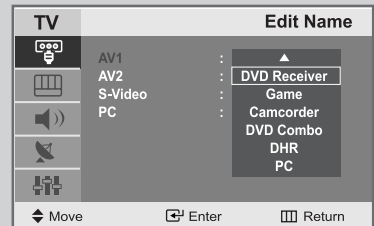
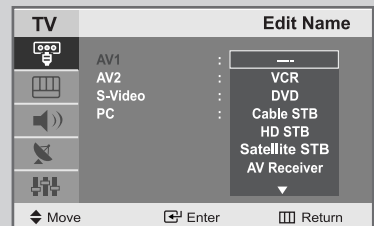

## Choosing Your Language

*When you start using your set for the first time, you must select the language which will be used for displaying menus and indicators.*

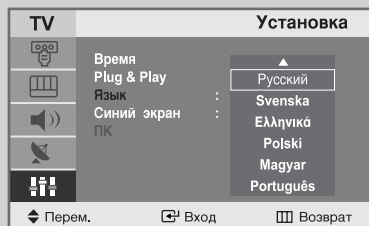
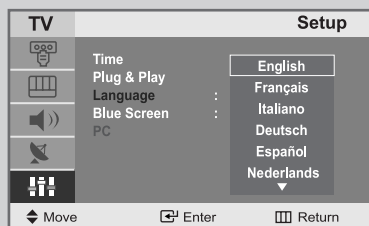

1 Press the **MENU** button.

Result: The main menu is displayed.

2 Press the **▲** or **▼** button to select the **Setup**.

Result: The options available in the **Setup** group are displayed.

3 Press the **ENTER** **⏏** button.

4 Press the **▲** or **▼** button to select the **Language**.

Press the **ENTER** **⏏** button.

5 Select a particular **Language** by pressing the **▲** or **▼** button repeatedly.

6 When you are satisfied with your choice, press the **EXIT** button to return to normal viewing.

## Storing Channels Automatically

*You can scan for the frequency ranges available to you (and availability depends on your country). Automatically allocated programme numbers may not correspond to actual or desired programme numbers. However you can sort numbers manually and clear any channels you do not wish to watch.*

1 Press the **MENU** button.

Result: The main menu is displayed.

2 Press the **▲** or **▼** button to select the **Channel**.

Result: The options available in the **Channel** group are displayed.

3 Press the **ENTER**  button.

4 Press the **▲** or **▼** button to select **Auto Store**.  
Press the **ENTER**  button.

Result: The **Start** is selected.

5 Press the **ENTER**  button to search the channels.  
The sub menu is changed from **Start** to **Stop** with channel search started.

Result: The search will end automatically.  
Channels are sorted and stored in an order which reflects their position in the frequency range, (with lowest first and highest last). The programme originally selected is then displayed.

➤ To stop the search before it has finished, press the **ENTER**  button to search the channels.

6 When the channels have been stored, you can:

- ◆ Add or delete the channels (refer to page 22)
- ◆ Sort them in the order required (refer to page 23)
- ◆ Assign a name to the stored channels (refer to page 24)

7 Press the **EXIT** button to exit.

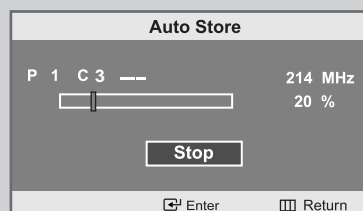
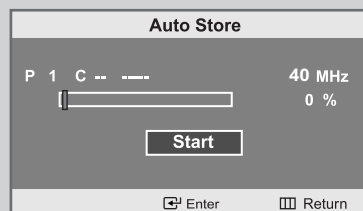
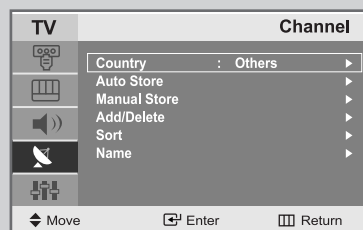

## Storing Channels Manually

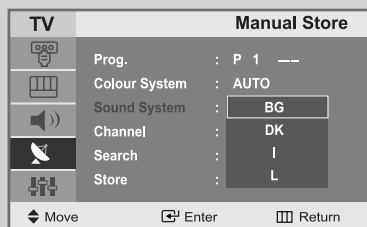
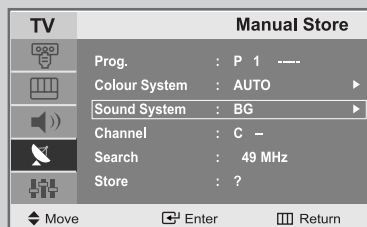
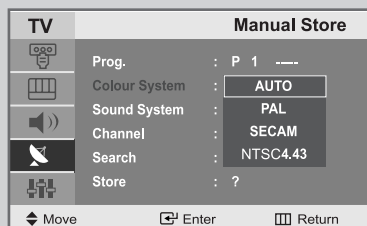
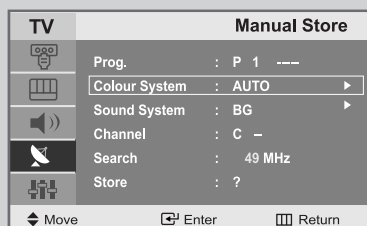

You can store up to 100 channels, including those received via cable networks.

When storing channels manually, you can choose:

- ◆ Whether or not to store each of the channels found
- ◆ The programme number of each stored channel which you wish to identify

- 1 Press the **MENU** button.  
Result: The main menu is displayed.
- 2 Press the **▲** or **▼** button to select the **Channel**.  
Result: The options available in the **Channel** group are displayed.
- 3 Press the **ENTER** button.  
Result: The options available in the **Manual Store** group are displayed with the **Prog.** selected.
- 4 Press the **▲** or **▼** button to select the **Manual Store**. Press the **ENTER** button.  
Result: The options available in the **Manual Store** required by pressing the **▲** or **▼** button repeatedly and then press the **ENTER** button.  
Result: The colour standards are displayed in the following order:  
**AUTO - PAL - SECAM - NTSC4.43**
- 5 Press the **▲** or **▼** button to select **Colour System**. Press the **ENTER** button. Select the **Colour System** required by pressing the **▲** or **▼** button repeatedly and then press the **ENTER** button.  
Result: The sound standards are displayed in the following order:  
**BG - DK - I - L**
- 6 Press the **▲** or **▼** button to select **Sound System**. Press the **ENTER** button. Select the **Sound System** required by pressing the **▲** or **▼** button repeatedly and then press the **ENTER** button.  
Result: The sound standards are displayed in the following order:  
**BG - DK - I - L**
- 7 For all the channels to move to the required channel numbers, repeat steps 5 to 6 after selecting **Prog.** by pressing the **▲** or **▼** button.

## Storing Channels Manually

- 8 If you know the channel number to be stored,
  - ◆ Press the ▲ or ▼ button to select the **Channel**. Press the **ENTER** button.
  - ◆ Select **C** (Air channel) or **S** (Cable channel) by pressing the ▲ or ▼ button and then press the **ENTER** button.
  - ◆ Select the required number by pressing the ▲ or ▼ button and then press the **ENTER** button.
    - If there is abnormal sound or no sound, re-select the sound system required.
    - You can also set a channel by pressing number buttons on the remote control.
- 9 If you do not know the channel numbers, press the ▲ or ▼ button to select **Search**. Press the **ENTER** button. Start the **Search** by pressing the ▲ or ▼ button. Press the **ENTER** button.

Result: The tuner scans the frequency range until the first channel or the channel that you selected is received on your screen.
- 10 Press the ▲ or ▼ button to select **Store**. Press the **ENTER** button. The **OK** is selected.

Result: The channel and associated programme number are stored.
- 11 Repeat Steps 8 to 10 for each channel to be stored.
- 12 Press the **EXIT** button to exit.

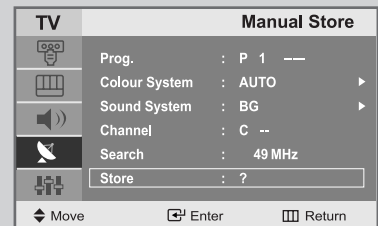
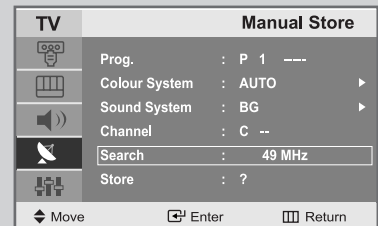
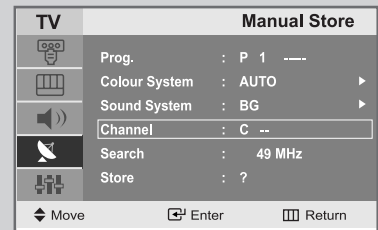



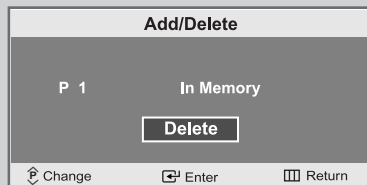
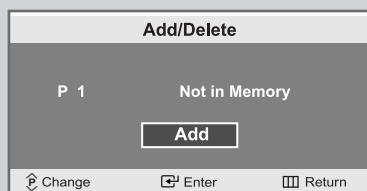

## Editing the Channels



*You can exclude any channels of your choice from the channels you have scanned. When you scan through the stored channels, those you have chosen to skip are not displayed.*

*All channels that you do not specifically choose to skip are displayed during scanning.*

- 1 Press the **MENU** button.  
Result: The main menu is displayed.
- 2 Press the **▲** or **▼** button to select the **Channel**.  
Result: The options available in the **Channel** group are displayed.
- 3 Press the **ENTER**  button.
- 4 Press the **▲** or **▼** button to select **Add/Delete**.  
Press the **ENTER**  button.  
Result: The state of the current channel is displayed.
- 5 Press the **^** or **v** button to select the channel that you wish to **Add** or **Delete**.  
Result: If the channel that you wish to edit is not in memory, Add is selected and displayed. Otherwise, if the channel that you wish to edit is in memory, Delete is selected and displayed.
- 6 Press the **ENTER**  button to **Add** or **Delete** the channel.
- 7 Repeat Step 5 for each channel to be added or erased.
- 8 Press the **EXIT** button to exit.

# Sorting the Stored Channels

You can exchange the numbers of two channels, in order to:

- ◆ *Modify the numeric order in which the channels have been automatically stored.*
- ◆ *Assign easily remembered numbers to the channels that you watch most often.*

1 Press the **MENU** button.

Result: The main menu is displayed.

2 Press the **▲** or **▼** button to select the **Channel**.

Result: The options available in the **Channel** group are displayed.

3 Press the **ENTER**  button.

4 Press the **▲** or **▼** button to select **Sort**.  
Press the **ENTER**  button.

Result: The current **Prog.**, **Channel** and **Name** are displayed.

5 Select the channel number that you wish to change by pressing the **▲** or **▼** button repeatedly.  
Press the **ENTER**  button.

Result: The selected **Channel** and **Name** are moved to the right side.

6 Press the **▲** or **▼** button to move to the position which you would like to change and then press the **ENTER**  button.

Result: The selected channel is exchanged with the one previously stored to the chosen number.

7 Repeat step 5 to 6 for another channel to sort again.

8 Press the **EXIT** button to exit.

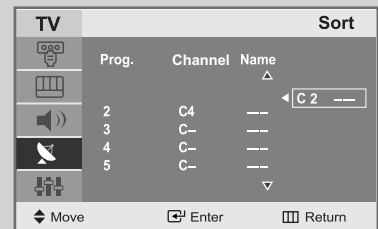
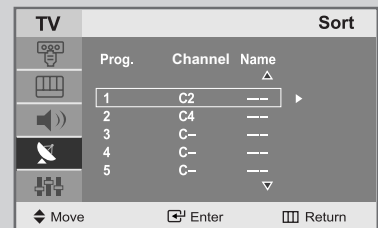
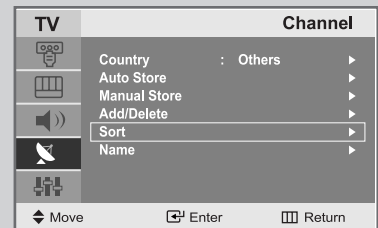

## Giving Channels Names

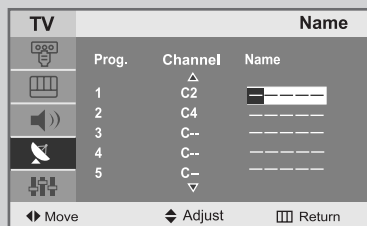
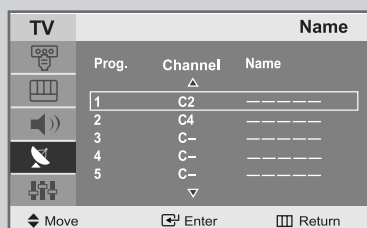

*If channel name information is broadcast when you store the channels either manually or automatically, the names are assigned to the channels directly. You can however change these names or assign new names as required.*

- 1 Press the **MENU** button.  
Result: The main menu is displayed.

---

- 2 Press the **▲** or **▼** button to select the **Channel**.  
Result: The options available in the **Channel** group are displayed.

---

- 3 Press the **ENTER** button.

---

- 4 Press the **▲** or **▼** button to select the **Name**.  
Press the **ENTER** button.  
Result: The current **Prog.**, **Channel** and **Name** are displayed.

---

- 5 If necessary, select the channel to be assigned to a new **Name** by pressing the **▲** or **▼** button.  
Press the **ENTER** button.  
Result: The selection bar is displayed around the name box.

---

- 6

To...	Then...
Select a letter, number or symbol	Press the <b>▲</b> or <b>▼</b> button
Move on to the next letter	Press the <b>▶</b> button
Move back to the previous letter	Press the <b>◀</b> button
Confirm the name	Press the <b>ENTER</b> button

➤ The characters available are :

  - ◆ Letters of the alphabet (A~Z)
  - ◆ Numbers (0~9)
  - ◆ Special characters (space, \_)

---

- 7 Repeat Steps **5** to **6** for each channel to be assigned to a new name.

---

- 8 When you have finished entering the name, press the **ENTER** button to confirm the name.

# Changing the Picture Standard

You can select the type of picture which best corresponds to your viewing requirements.

- 1 Press the **MENU** button.

Result: The main menu is displayed.

- 2 Press the **▲** or **▼** button to select the **Picture**.

Result: The options available in the **Picture** group are displayed.

- 3 Press the **ENTER**  button.

Result: The **Mode** is selected.

- 4 Press the **ENTER**  button.

- 5 Select the required picture effect by pressing the **▲** or **▼** button repeatedly.

Press the **ENTER**  button.

Result: The following picture effects are available:  
**Dynamic - Standard - Movie - Custom**

- 6 Press the **EXIT** button to exit.

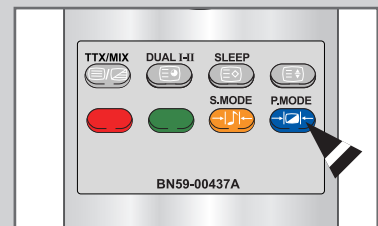
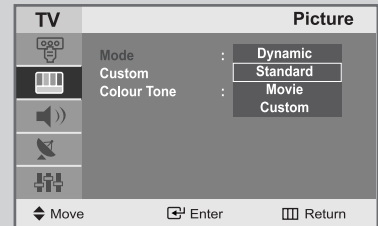
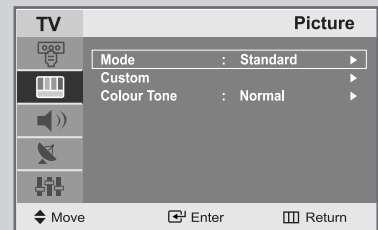

➤ You can also set these options simply by pressing the **P.MODE** (Picture Mode) button.

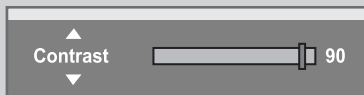
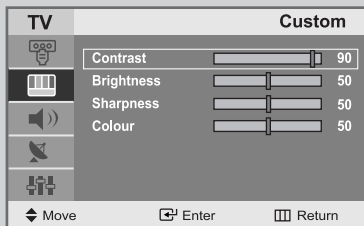
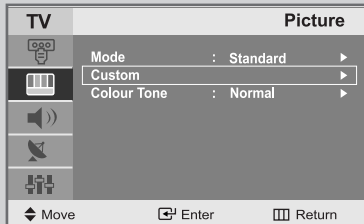
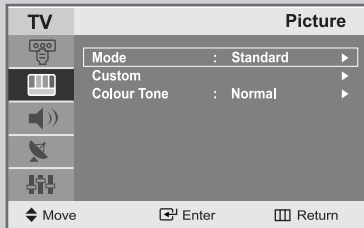

## Adjusting the Custom Picture



Your set has several settings which allow you to control picture quality.

- 1 Press the **MENU** button.  
Result: The main menu is displayed.
- 2 Press the **▲** or **▼** button to select the **Picture**.  
Result: The options available in the **Picture** group are displayed.
- 3 Press the **ENTER**  button.
- 4 Press the **▲** or **▼** button to select the **Custom**.  
Press the **ENTER**  button.
- 5 Select the option (**Contrast**, **Brightness**, **Sharpness**, **Colour** or **Tint-NTSC** only) to be adjusted by pressing the **▲** or **▼** button.  
Press the **ENTER**  button.  
Result: The horizontal bar is displayed.
- 6 Press the **◀** or **▶** button to reach the required setting.
- 7 When you are satisfied with the setting, press the **MENU** button to return to the previous menu or press the **EXIT** button to return to normal viewing.

➤ If you make any changes to these settings, the picture standard is automatically switched to **Custom**.

# Adjusting the Screen Background Colour

You can change the screen background colour according to your preference.

- 1 Press the **MENU** button.

Result: The main menu is displayed.

- 2 Press the **▲** or **▼** button to select the **Picture**.

Result: The options available in the **Picture** group are displayed.

- 3 Press the **ENTER**  button.

- 4 Press the **▲** or **▼** button to select the **Colour Tone**.  
Press the **ENTER**  button.

Result: The following options are available:  
**Cool 2 - Cool 1 - Normal - Warm 1 - Warm 2**

- 5 When you are satisfied with your choice, press the **EXIT** button to return to normal viewing.

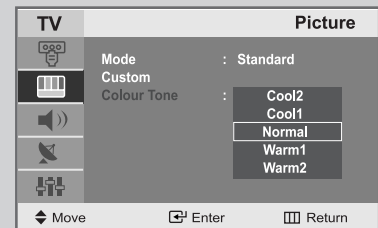
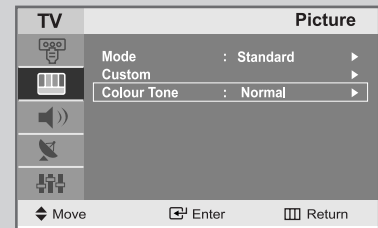
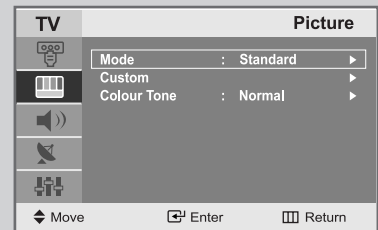

## Changing the Sound Standard

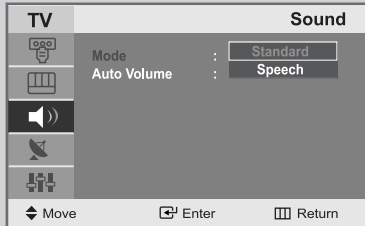
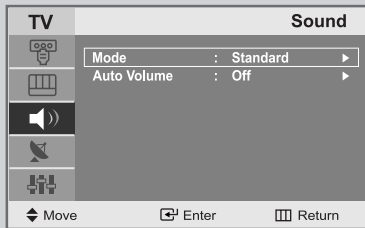

*You can select the type of special sound effect to be used when watching a given broadcast.*

1 Press the **MENU** button.

Result: The main menu is displayed.

2 Press the **▲** or **▼** button to select the **Sound**.

Result: The options available in the **Sound** group are displayed.

3 Press the **ENTER**  button.

Result: The **Mode** is selected.

4 Press the **ENTER**  button.

5 Select the required sound effect by pressing the **▲** or **▼** button repeatedly.

Press the **ENTER**  button.



Result: The following sound effects are available:  
**Standard - Speech**

6 Press the **EXIT** button to exit.

➤ You can also set these options simply by pressing the **S.MODE** (Sound Mode) button.

# Selecting Auto Volume Control

*Reduces the differences in volume level between broadcasters.*



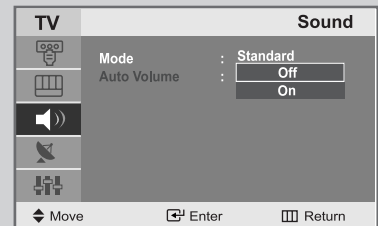
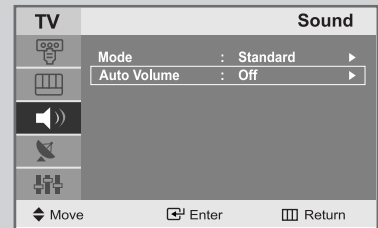
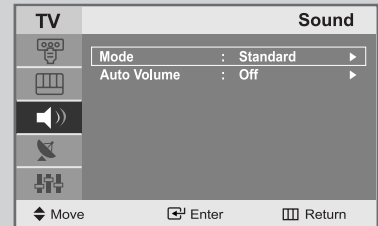

- 1 Press the **MENU** button.  
Result: The main menu is displayed.
- 2 Press the **▲** or **▼** button to select the **Sound**.  
Result: The options available in the **Sound** group are displayed.
- 3 Press the **ENTER**  button.
- 4 Press the **▲** or **▼** button to select **Auto Volume**.  
Press the **ENTER**  button.
- 5 Press the **▲** or **▼** button to select **Off/On**.  
Press the **ENTER**  button.
- 6 Press the **EXIT** button to exit.



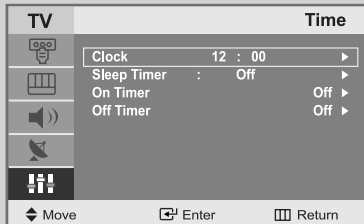
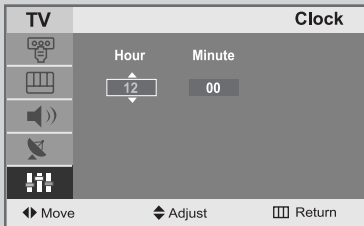
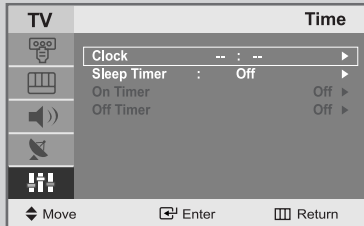

# Setting the Clock



- 1 Press the **MENU** button.  
Result: The main menu is displayed.
- 2 Press the **▲** or **▼** button to select **Setup**.  
Result: The options available in the **Setup** group are displayed.
- 3 Press the **ENTER**  button.
- 4 Press the **ENTER**  button.  
Result: The **Clock** is selected.
- 5 Press the **ENTER**  button.  
Press the **▲** or **▼** button to set the **Hour**.
- 6 Press the **◀** or **▶** button to move to **Minute**.  
Press the **▲** or **▼** button to set the minutes.
- 7 Press the **ENTER**  button.  
Result: The clock is set.
- 8 Press the **EXIT** button to exit.

➤ You can also set the time using the numeric buttons on the remote.

# Switching Off Automatically

You can select a time period of between **Off** and **180 minutes** after which your set automatically switches off.

- 1 Press the **MENU** button.

Result: The main menu is displayed.

- 2 Press the **▲** or **▼** button to select **Setup**.

Result: The options available in the **Setup** group are displayed.

- 3 Press the **ENTER** button.

- 4 Press the **ENTER** button.

Result: The preset **Clock** is selected.

- 5 Press the **▲** or **▼** button to select the **Sleep Timer**. Press the **ENTER** button.

- 6 Select the number of minutes after which your set switches **On** by pressing the **▲** or **▼** button repeatedly.

Result: The preset time intervals:  
**Off, 30, 60, 90, 120, 150, 180 minutes.**

- 7 Press the **EXIT** button to exit.

- You can also select this feature by simply pressing the **"SLEEP"** button.

If the sleep timer is already set, the screen displays the remaining time and then your set will be switched **Off**.

If the sleep timer is not yet set, **Off** is displayed.

◆ Off • 30 • 60 • 90 • 120 • 150 • 180

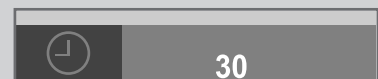
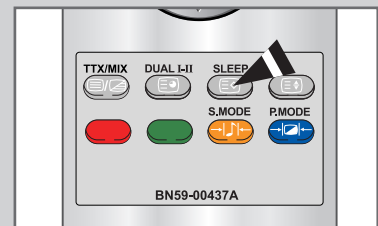
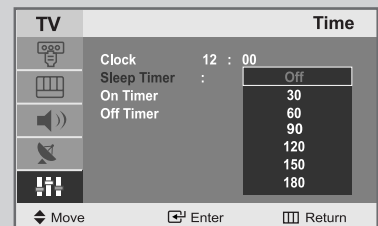
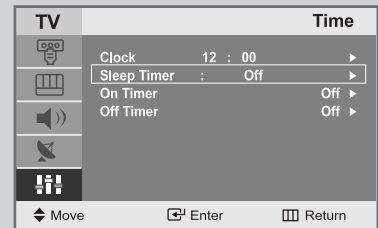
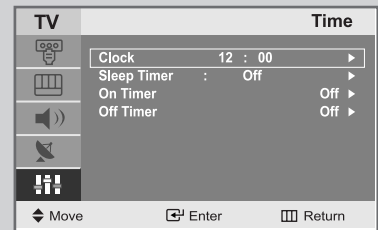

# Switching the Television On and Off Automatically

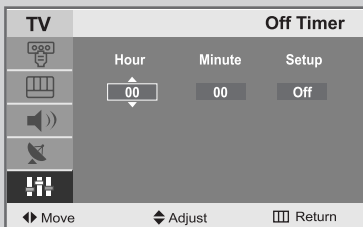
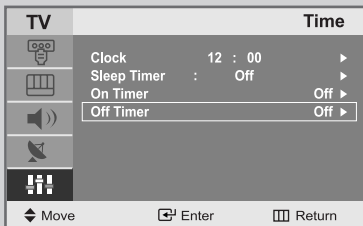
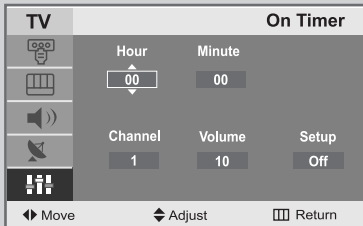
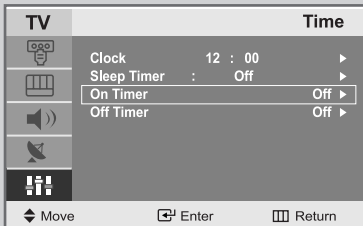
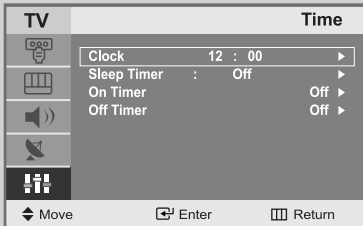

You can set the On/Off timers so that the set will:

- ◆ Switch on automatically and tune to the channel of your choice at the time you select.
- ◆ Switch off automatically at the time you select.

- 1 Press the **MENU** button.  
Result: The main menu is displayed.

---

- 2 Press the **▲** or **▼** button to select **Setup**.  
Result: The options available in the **Setup** group are displayed.

---

- 3 Press the **ENTER** button.

---

- 4 Press the **ENTER** button.  
Result: The **Time** menu are displayed with **Clock** selected.

---

- 5 Press the **▲** or **▼** button to select the **On Timer**. Press the **ENTER** button.  
Result: The **On Timer** menu is displayed.

To...	Press the...
Move to <b>Hour, Minute, Channel</b> and <b>Volume</b>	<b>◀</b> or <b>▶</b> button
Set <b>Hour, Minute, Channel</b> and <b>Volume</b> level	<b>▲</b> or <b>▼</b> button
Move to <b>Setup</b>	<b>◀</b> or <b>▶</b> button
Select <b>On</b> to enable above setting	<b>▲</b> or <b>▼</b> button

- 6 Press the **MENU** button to return to the previous menu and to set **Off Timer** continuously. Press the **▲** or **▼** button to select **Off Timer**.

In the same way, set the time at which you wish the set to be switched off automatically.



- 7 Press the **EXIT** button to exit.

➤ You can also set hour and minute by pressing the number buttons on the remote control.

## Setting the Blue Screen Mode

If no signal is being received or the signal is very weak, a blue screen automatically replaces the noisy picture background.

If you wish to continue viewing the poor picture, you must set the "Blue Screen" mode to "Off".

- 1 Press the **MENU** button.  
Result: The main menu is displayed.
- 2 Press the **▲** or **▼** button to select **Setup**.  
Result: The options available in the **Setup** group are displayed.
- 3 Press the **ENTER**  button.
- 4 Press the **▲** or **▼** button to select **Blue Screen**.  
Press the **ENTER**  button.
- 5 Select the required option (**On** or **Off**) by pressing the **▲** or **▼** button.
- 6 Press the **EXIT** button to return to normal viewing.

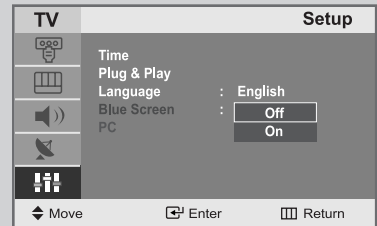
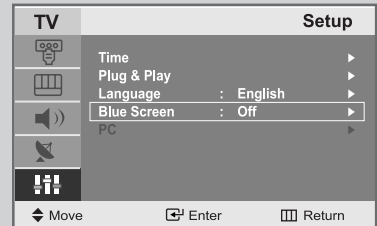

## Displaying Information

You can view the setting status of the selected source by pressing the "INFO" button on the remote control.

The information displayed varies according to the selected source.

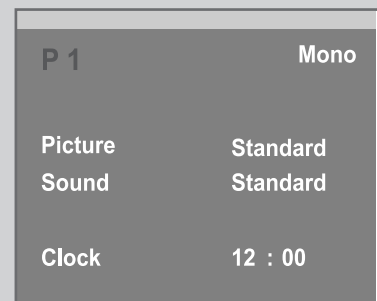

## Teletext Feature

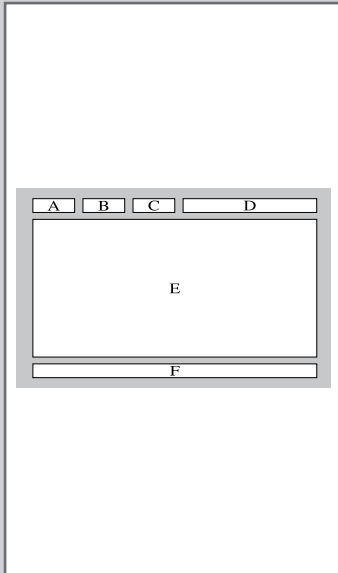

*Most television channels provide written information services via teletext.*

*Information provided includes:*

- ◆ *Television programme times*
- ◆ *News bulletins and weather forecasts*
- ◆ *Sports results*
- ◆ *Travel information*

*This information is divided into numbered pages (see diagram).*

Part	Contents
A	Selected page number.
B	Broadcasting channel identity.
C	Current page number or search indicators.
D	Date and time.
E	Text.
F	Status information. FASTEXT information.





- Teletext information is often divided between several pages displayed in sequence, which can be accessed by:
- ◆ Entering the page number
  - ◆ Selecting a title in a list
  - ◆ Selecting a coloured heading (FASTEXT system)

## Displaying the Teletext Information

You can display Teletext information at any time on your set.

 For Teletext information to be displayed correctly, channel reception must be stable; otherwise:

- ◆ Information may be missing
- ◆ Some pages may not be displayed

- 1 Select the channel providing the Teletext service using the  or  button.
- 2 Press the **TTX/MIX** button to activate the teletext mode.  
Result: The contents page is displayed. It can be redisplayed at any time by pressing the  (index) button.
- 3 If you wish to display the actual broadcast at the same time as the teletext page, press the **TTX/MIX** button again.
- 4 Press the **TV**() button again to exit the teletext display.



## Selecting a Page by Number



You can enter the page number directly by pressing the numeric buttons on the remote control.

- 1 Enter the three-digit page number given in the content by pressing the corresponding numeric buttons.

**Result:** The current page counter is incremented and the page is then displayed.



- 2 If the selected page is linked with several secondary pages, the secondary pages are displayed in sequence. To freeze the display on a given page, press the (hold) button. Press the (hold) button again to resume.

**Using the various display options:**

To display...	Press the...
◆ Hidden text (answers to quiz games, for example)	(reveal)
◆ The normal screen	(reveal) again
◆ A secondary page, by entering its 4-digit number	(subpage)
◆ The next page	(page up)
◆ The previous page	(page down)
◆ Double-size letters in the: <ul style="list-style-type: none"> <li>• Upper half of the screen</li> <li>• Lower half of the screen</li> </ul>	(size) <ul style="list-style-type: none"> <li>• Once</li> <li>• Twice</li> </ul>
◆ Normal screen	• Three times

## Using FLOF to Select a Page



The various topics included in the teletext pages are colour-coded, and can be selected by pressing the coloured buttons on the remote control.

- 1 Display the teletext contents page by pressing the **TTX/MIX** button.
- 2 Press the coloured button corresponding to the topic that you wish to select; the available topics are given on the status line.  
**Result:** The page is displayed with other coloured information that can be selected in the same way.
- 3 To display the previous or next page, press the corresponding coloured button.
- 4 To display the subpage, see the following steps.
  - ◆ Press the  (subpage) button.**Result:** The available subpages appear.
  - ◆ Select the required subpage.  
Subpages can be scrolled by using the  or  button.



## Storing Teletext Pages

You can store up to four teletext pages to display them later at leisure.

- 1 Select the LIST mode using the  (LIST/FLOF) button.  
**Result:** Four 3-digit numbers are displayed in different colours.
  - The  (LIST/FLOF) button is used to switch between the LIST and FLOF modes.
- 2 Press the coloured button corresponding to the page that will be replaced.
- 3 Enter the new page number using the numeric buttons.
- 4 Repeat steps 2 and 3 for each page to be stored, using a different coloured button each time.
- 5 Press the  (store) button until the corresponding blocks blink.





# Setting Up Your PC Software (Based on Windows XP)

The Windows display-settings for a typical computer are shown below. The actual screens on your PC will probably be different, depending upon your particular version of Windows and your particular video card. However, even if your actual screens look different, the same basic set-up information will apply in almost all cases. (If not, contact your computer manufacturer or Samsung Dealer.)

- 1 First, click on “**Control Panel**” on the Windows start menu.

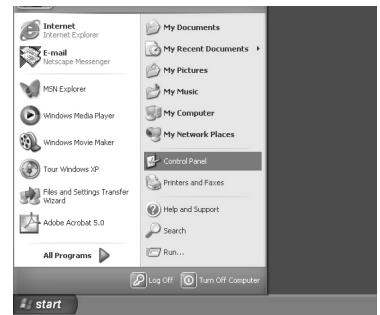

- 2 When the control panel window appears, click on “**Appearance and Themes**” and a display dialog-box will appear.

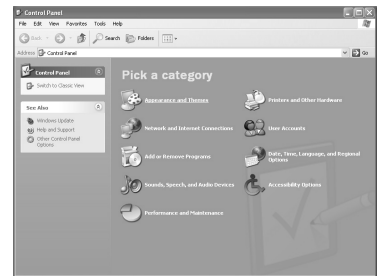

- 3 When the control panel window appears, click on “**Display**” and a display dialog-box will appear.

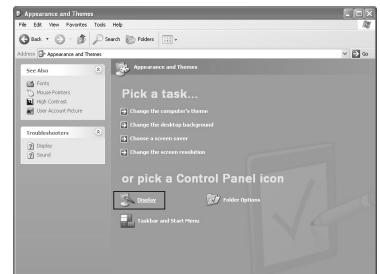

- 4 Navigate to the “**Settings**” tab on the display dialog-box. The correct size setting (resolution) - refer to page 47, 49

If a vertical-frequency option exists on your display settings dialog box, the correct value is “**60**” or “**60 Hz**”. Otherwise, just click “**OK**” and exit the dialog box.



# Coarse and Fine Tuning of the Image

➤ Preset to PC mode by pressing the **SOURCE** button on the remote control .

1 Press the **MENU** button.

Result: The main menu is displayed.

2 Press the ▲ or ▼ button to select **Setup**.

Result: The options available in the **Setup** group are displayed.

3 Press the **ENTER**  button.

4 Press the ▲ or ▼ button to select **PC**.

Press the **ENTER**  button.

Result: The options available in the **PC** menu are displayed.

5 Press the **ENTER**  button.

Result: The **Image Lock** menu is selected.

6 Press the ▲ or ▼ button to select **Coarse** or **Fine**.

Press the **ENTER**  button.

Result: The horizontal bar is displayed.

7 Press the ◀ or ▶ button to adjust the screen quality.  
Vertical stripes may appear or the picture may become blurry.

8 When you are satisfied with the settings, press the **MENU** button to return to the previous menu or press the **EXIT** button to return to normal viewing.

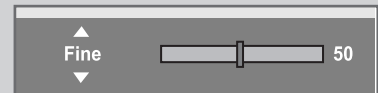
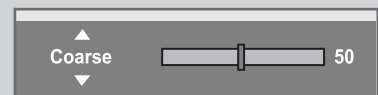
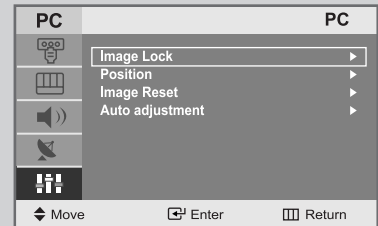
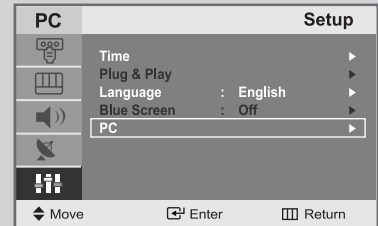
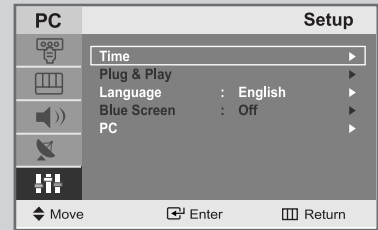

# Changing the Image Position

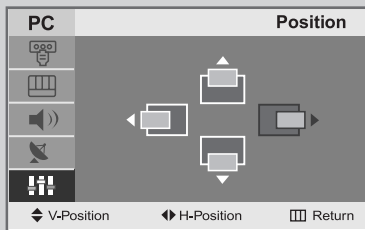
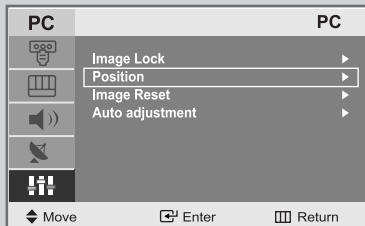
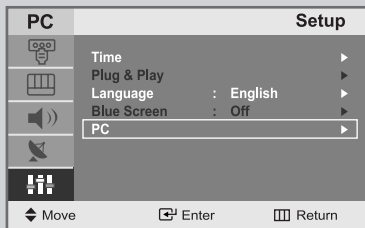

➤ Preset to PC mode by pressing the **SOURCE** button on the remote control.

1 Press the **MENU** button.

Result: The main menu is displayed.

2 Press the **▲** or **▼** button to select **Setup**.

Result: The options available in the **Setup** group are displayed.

3 Press the **ENTER**  button.

4 Press the **▲** or **▼** button to select **PC**.  
Press the **ENTER**  button.

Result: The options available in the **PC** menu are displayed.

5 Press the **▲** or **▼** button to select **Position**.  
Press the **ENTER**  button.

Result: You can adjust the image **Position**.

6 Press the **▲** or **▼** button to adjust the vertical position.  
Press the **◀** or **▶** button to adjust the horizontal position.

7 Press the **MENU** button to return to the previous menu or  
press the **EXIT** button to return to normal viewing.

# Initializing the Image Settings

➤ Preset to PC mode by pressing the **SOURCE** button on the remote control .

*You can replace all image settings with the factory default values.*

- 1 Press the **MENU** button.

Result: The main menu is displayed.

- 2 Press the ▲ or ▼ button to select **Setup**.

Result: The options available in the **Setup** group are displayed.

- 3 Press the **ENTER**  button.

- 4 Press the ▲ or ▼ button to select **PC**.  
Press the **ENTER**  button.

Result: The options available in the **PC** menu are displayed.

- 5 Press the ▲ or ▼ button to select **Image Reset**.  
Press the **ENTER**  button.

Result: The message “**Image Reset has completed.**” is displayed.

- 6 Press the **MENU** button to return to the previous menu or  
press the **EXIT** button to return to normal viewing.

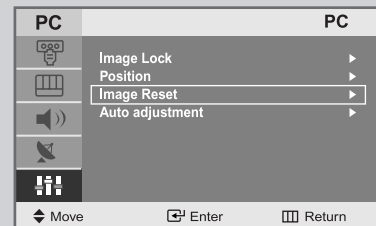
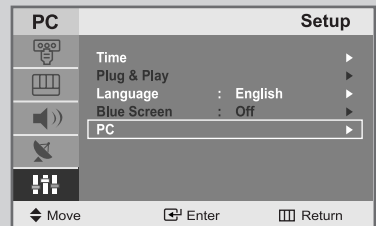
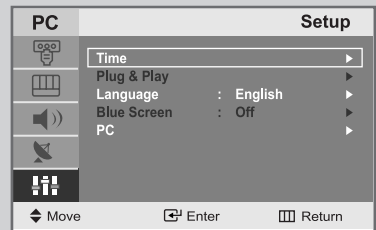
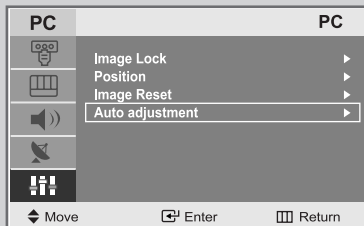

Image Reset has completed.

## Adjusting the PC Screen Automatically



Auto adjustment

➤ Preset to PC mode by pressing the **SOURCE** button on the remote control .

1 Press the **MENU** button.

Result: The main menu is displayed.

2 Press the **▲** or **▼** button to select **Setup**.

Result: The options available in the **Setup** group are displayed.

3 Press the **ENTER**  button.

4 Press the **▲** or **▼** button to select **PC**.

Press the **ENTER**  button.

Result: The options available in the **PC** menu are displayed.

5 Press the **▲** or **▼** button to select **Auto adjustment**.



Press the **ENTER**  button.

Result: The screen quality and position are automatically adjusted, and the screen returns to the original view a few seconds later.

6 Press the **MENU** button to return to the previous menu or press the **EXIT** button to return to normal viewing.

## Picture Mode

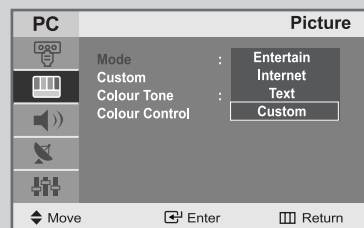
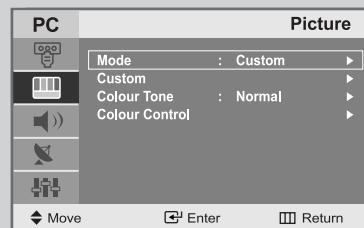

You can select the type of picture which best corresponds to your viewing requirements.

- 1 Press the **MENU** button.  
Result: The main menu is displayed.
- 2 Press the **▲** or **▼** button to select the **Picture**.  
Result: The options available in the **Picture** group are displayed.
- 3 Press the **ENTER**  button.  
Result: The **Mode** is selected.
- 4 Press the **ENTER**  button.
- 5 Select the required picture effect by pressing the **▲** or **▼** button repeatedly. Press the **ENTER**  button.  
Result: The following picture effects are available:  
**Entertain - Internet - Text - Custom**
- 6 Press the **EXIT** button to exit.



## Adjusting the Custom Picture

Your set has several settings which allow you to control picture quality.

- 1 Press the **MENU** button.  
Result: The main menu is displayed.
- 2 Press the **▲** or **▼** button to select the **Picture**.  
Result: The options available in the **Picture** group are displayed.
- 3 Press the **ENTER**  button.
- 4 Press the **▲** or **▼** button to select the **Custom**. Press the **ENTER**  button.
- 5 Select the option (**Contrast, Brightness**) to be adjusted by pressing the **▲** or **▼** button. Press the **ENTER**  button.  
Result: The horizontal bar is displayed.
- 6 Press the **◀** or **▶** button to reach the required setting.
- 7 When you are satisfied with the setting, press the **MENU** button to return to the previous menu or press the **EXIT** button to return to normal viewing.

➤ If you make any changes to these settings, the picture standard is automatically switched to **Custom**.

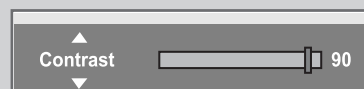
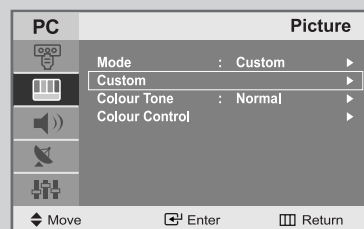
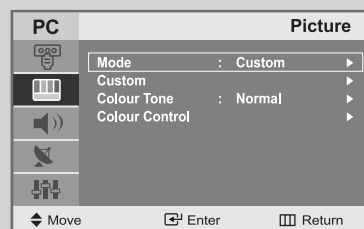

## Adjusting the Screen Background Colour

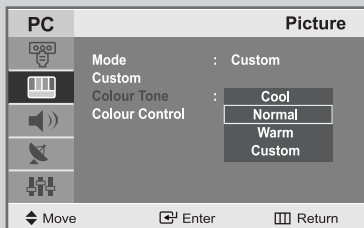
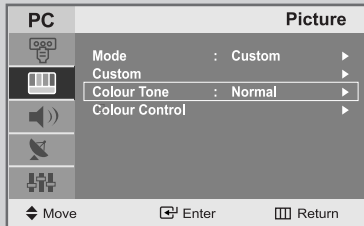
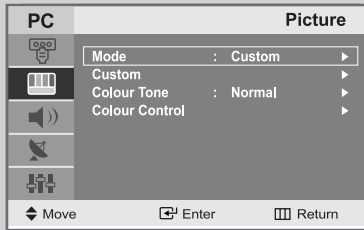

*You can change the screen background colour according to your preference.*

- 1 Press the **MENU** button.

Result: The main menu is displayed.

- 2 Press the **▲** or **▼** button to select the **Picture**.

Result: The options available in the **Picture** group are displayed.

- 3 Press the **ENTER**  button.

- 4 Press the **▲** or **▼** button to select the **Colour Tone**.  
Press the **ENTER**  button.

Result: The following options are available:  
**Cool - Normal - Warm - Custom**

- 5 When you are satisfied with your choice, press the **EXIT** button to return to normal viewing.

## Customizing the Colour

- 1 Press the **MENU** button.

Result: The main menu is displayed.

- 2 Press the **▲** or **▼** button to select the **Picture**.

Result: The options available in the **Picture** group are displayed.

- 3 Press the **ENTER**  button.

- 4 Press the **▲** or **▼** button to select the **Colour Control**.  
Press the **ENTER**  button.

- 5 Select the option (**Red, Green, Blue**) to be adjusted by pressing the **▲** or **▼** button.

Press the **ENTER**  button.

Result: The horizontal bar is displayed.

- 6 Press the **◀** or **▶** button to reach the required setting.

- 7 When you are satisfied with the setting, press the **MENU** button to return to the previous menu or press the **EXIT** button to return to normal viewing.

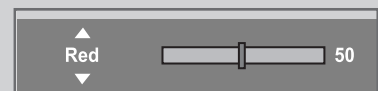
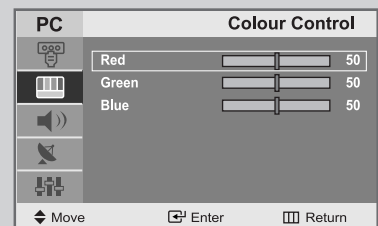
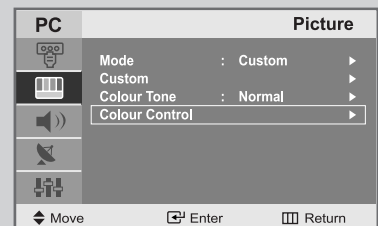
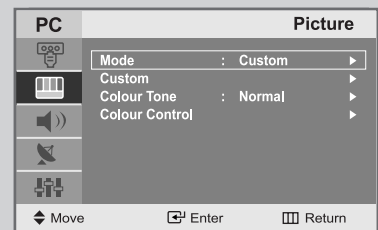



## Troubleshooting: Before Contacting Service Personnel

*Before contacting Samsung after-sales service, perform the following simple checks.*

*If you cannot solve the problem using the instructions below, note the model and serial number of your set and contact your local dealer.*

---

No sound or picture.	<ul style="list-style-type: none"><li>◆ Check that the mains lead has been connected to a wall socket.</li><li>◆ Check that you have pressed the <b>POWER</b> button.</li><li>◆ Check the picture contrast and brightness settings.</li><li>◆ Check the volume.</li></ul>
Normal picture but no sound.	<ul style="list-style-type: none"><li>◆ Check the volume.</li><li>◆ Check whether the <b>MUTE</b>  button has been pressed on the remote control.</li></ul>
No picture or black and white picture.	<ul style="list-style-type: none"><li>◆ Adjust the colour settings.</li><li>◆ Check that the broadcast system selected is correct.</li></ul>
Sound and picture interference.	<ul style="list-style-type: none"><li>◆ Try to identify the electrical appliance that is affecting the set and move it further away.</li><li>◆ Plug your set into a different mains socket.</li></ul>
Blurred or snowy picture, distorted sound.	<ul style="list-style-type: none"><li>◆ Check the direction, location and connections of your aerial. This interference is often due to the use of an indoor aerial.</li></ul>
Remote control malfunctions.	<ul style="list-style-type: none"><li>◆ Replace the remote control batteries.</li><li>◆ Clean the upper edge of the remote control (transmission window).</li><li>◆ Check the battery terminals.</li></ul>
"Check signal cable" message is displayed.	<ul style="list-style-type: none"><li>◆ Check that the signal cable is firmly connected to the PC.</li><li>◆ Check that the PC is turned on.</li></ul>
In PC mode, "Mode Not Supported" message is displayed.	<ul style="list-style-type: none"><li>◆ Check the maximum resolution and the frequency of the video adapter.</li><li>◆ Compare these values with the data in the Display Modes. (refer to page 49)</li></ul>
In PC mode, horizontal or vertical bars appear to flicker, jitter or shimmer on the image.	<ul style="list-style-type: none"><li>◆ Adjust the Coarse or Fine function. (refer to page 39)</li></ul>
In PC mode, the screen is black and the power indicator light is steady amber or blinks every 0.5 or 1 seconds.	<ul style="list-style-type: none"><li>◆ The TV is using its power management system.</li><li>◆ Move the computer's mouse or press any key on the keyboard.</li></ul>

---

## Troubleshooting: Before Contacting Service Personnel

In PC mode, the image is not stable and may appear to vibrate.

- ◆ Check that the display resolution and frequency from your computer or video board is an available mode for your set. On your computer check: Control Panel, Display, Settings.
- ◆ If the setting is not correct, use your computer utility programme to change the display settings.

➤ Your set supports multiscan display functions within the following frequency domain:

	15"(LW15M23C)	17"(LW17M24C)/ 17"(LW17M24CU)	20"(LW20M21C)	20"(LW20M22C)/ 20"(LW20M21CU)
<b>Horizontal frequency(kHz)</b>	30-69	30-80	28-33	28-47
<b>Vertical frequency(Hz)</b>	50-75	50-75	50-70	50-75
<b>Maximum refresh rate (at 75Hz)</b>	1024X768	1280X1024	640X480	800X600

In PC mode, the image is not centred on the screen.

- ◆ Adjust the horizontal and vertical position.

TFT LCD panel manufactured by using advanced semiconductor technology with precision of 1ppm(one millionth) above is used for this product. This is not from bad quality and you can use it without uneasiness.

For example, the number of TFT LCD sub pixels: LW15M23C - 2,359,296, LW17M24C/LW17M24CU - 3,932,160, LW20M21C - 921,600, LW20M21CU, LW20M22C - 1,440,000

## Power Saver

*This set has a built-in power management system called PowerSaver. This system saves energy by switching your set into a low-power mode when it has not been used for a certain period of time. The available modes are "On", "Standby", "Sleep", and "Deep Sleep". PowerSaver operates with a VESA DPMS compliant video card installed in your computer. You use a software utility installed on your computer to set up this feature.*

State	Normal Operation	Power-Saving Function mode (EPA/NUTEK)
Horizontal Sync	Active	Inactive
Vertical Sync	Active	Inactive
Power Indicator	Off	Red, Blinking (1 sec interval)
Power Consumption	15" 40W, 17" 45W, 20" 55W	Less than 3W

- ***This set automatically returns to normal operation when horizontal and vertical sync are restored. This occurs when you move the computer's mouse or press any key on the keyboard.***

# Technical and Environmental Specifications

Model Name	LW15M23C	LW17M24C/LW17M24CU	LW20M21C	LW20M21CU/LW20M22C
<b>Panel Size</b>	331.6(H) x 254.9(V)mm 13.05(H) x 10.03(V)inch	383.5(H) x 298.0(V)mm 15.09(H) x 11.73(V)inch	413.0(H) x 311.0(V)mm 16.25(H) x 12.24(V)inch	413.0(H) x 311.0(V)mm 16.25(H) x 12.24(V)inch
<b>Display Size</b>	304.1(H) x 228.1(V)mm 11.97(H) x 8.98(V)inch	337.9(H) x 270.3(V)mm 13.30(H) x 10.64(V)inch	408.0(H) x 306.0(V)mm 16.06(H) x 12.05(V)inch	408.0(H) x 306.0(V)mm 16.06(H) x 12.05(V)inch
<b>Type</b>	a-si TFT active matrix	a-si TFT active matrix	a-si TFT active matrix	a-si TFT active matrix
<b>Pixel Pitch</b>	0.297(H) x 0.297(V)mm	0.264(H) x 0.264(V)mm	0.6375(H) x 0.6375(V)mm	0.51(H) x 0.51(V)mm
<b>Viewing Angle</b>	140/115	140/120	160/150	160/120
<b>Frequency</b>				
Horizontal	30 ~ 69kHz	30 ~ 80 kHz	28 ~ 33kHz	28 ~ 47kHz
Vertical	50 ~ 75Hz	50 ~ 75Hz	50 ~ 70Hz	50 ~ 75Hz
Display Color	16.2 Million	16.2 Million	16.7 Million	16.7 Million
<b>Resolution</b>				
Optimum	1024 x 768@60Hz	1280 x 1024@60Hz	640 x 480@60Hz	800 x 600@60Hz
Maximum	1024 x 768@75Hz	1280 x 1024@75Hz	640 x 480@70Hz	800 x 600@75Hz
<b>Input Signal</b>	H/V Separate, TTL, P or N 0.7 Vp-p @75 Ω			
Sync. Video Signal				
<b>Video</b>	PAL / NTSC / SECAM CVBS, S-VHS, RGB			
Color System Video System				
<b>Power Supply</b>	AC 100V ~ 240V (50 / 60Hz)			
Input				
<b>Power Consumption</b>				
Maximum	40W	45W	55W	55W
Power Saving	<3W	<3W	<3W	<3W
<b>Dimension (W x D x H)</b>				
TV Body	360.2 x 64.2 x 338.6 mm (14.18 x 2.53 x 13.33 inch)	416.7x 71.8 x 392.9 mm (16.40 x 2.82 x 15.46 inch)	479.0 x 74.7 x 436.4 mm (18.86 x 2.94 x 17.18 inch)	479.0 x 74.7 x 436.4 mm (18.86 x 2.94 x 17.18 inch)
With stand	360.2 x 192.9 x 396.5 mm (14.18 x 7.59 x 15.61 inch)	416.7 x 192.9 x 423.8 mm (16.40 x 7.59 x 16.68 inch)	479.0 x 226.0 x 463.0 mm (18.86 x 8.90 x 18.23 inch)	479.0 x 226.0 x 463.0 mm (18.86 x 8.90 x 18.23 inch)
<b>Weight</b>				
With stand	3.6 kg (7.94 lbs)	4.95 kg (10.91 lbs)	7.15 kg (15.76 lbs)	7.45 kg (16.42 lbs)
<b>Environmental Considerations</b>	50°F to 104°F (10°C to 40°C) 10% to 80%, non-condensing -4°F to 113°F (-20°C to 45°C) 5% to 95%, non-condensing			
<b>Audio Characteristics</b>	RCA Jack (L, R), 0.5Vrms(-9dB) 3.5Ø Stereo Jack, 0.5Vrms(-9dB) 2.5W x 2 Max.10mW Output(3,5Ø Stereo Jack 32) RF : 80Hz ~15kHz at -3dB A/V : 80Hz ~20kHz at -3dB			
Audio Input				
PC Audio Input				
Audio Output				
Headphone Output				
Frequency Response				

## Display Modes

If the signal from the system equals the standard signal mode, the screen is adjusted automatically. If the signal from the system doesn't equal the standard signal mode, adjust the mode by referring to your Videocard user guide; otherwise there may be no video. For the display modes listed below, the screen image has been optimized during manufacture.

Mode(PC)		Resolution	Horizontal Frequency (kHz)	Vertical Frequency (Hz)	Pixel Clock Frequency (MHz)	Sync Polarity (H/V)
<b>VGA</b>	LW15M23C 17M24C 17M24CU 20M21C 20M21CU 20M22C	720X400	31.469	70.087	28.322	- / +
		640X480	31.469	59.940	25.175	- / -
	LW15M23C 17M24C 17M24CU 20M21CU 20M22C	640X480	37.500	75.000	31.500	- / -
<b>SVGA</b> LW15M23C, 17M24C, 20M21CU, 20M22C		800X600	46.875	75.000	49.500	+ / +
		800X600	37.879	60.317	40.000	+ / +
<b>XGA</b> LW15M23C, 17M24C, 17M24CU		1024X768	48.363	60.004	65.000	- / -
		1024X768	60.023	75.029	78.750	+ / +
<b>SXGA</b> LW17M24C, LW17M24CU		1280X1024	63.981	60.020	108.000	+,- / -,+
		1280X1024	79.976	75.025	135.000	+ / +

## Retractable Stand

Note: The maximum tilt angle is 13 degrees in the backward direction.

Please do not tilt the TV outside the specified range. Using excessive force to tilt the TV may cause permanent damage to the mechanical part of the stand.

< LW20M21C / LW20M21CU / LW20M22C > model swivels left and right.



< LW15M23C / LW17M24C / LW17M24CU >



< LW20M21C / LW20M21CU / LW20M22C >

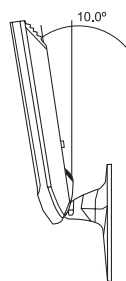
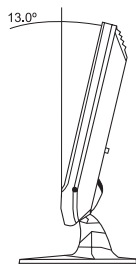

## Using Your TV in Another Country

If you plan to take your TV with you to a foreign country, please be aware of the different television systems that are in use around the world.

A TV designed for one system may not work properly with another system due to differences in the TV channel frequencies.

## Using the Anti-Theft Kensington Lock

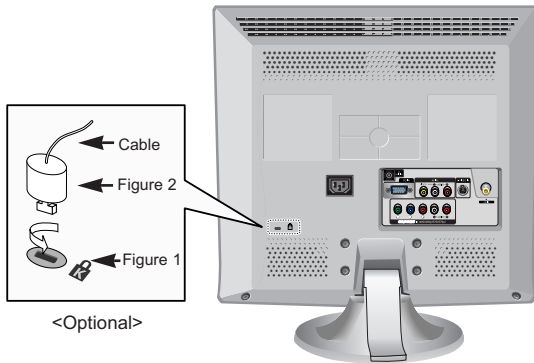

The Kensington lock is a device used to physically fix the system when using it in a public place. The locking device has to be purchased separately.

The appearance and locking method may differ from the illustration depending on the manufacturer. Please refer to the manual provided with the Kensington lock for proper use.

1. Insert the locking device into the Kensington slot on the LCD TV (Figure 1), and turn it in the locking direction (Figure 2).
2. Connect the Kensington lock cable.
3. Fix the Kensington lock to a desk or a heavy stationary object.

## Installing VESA compliant mounting devices

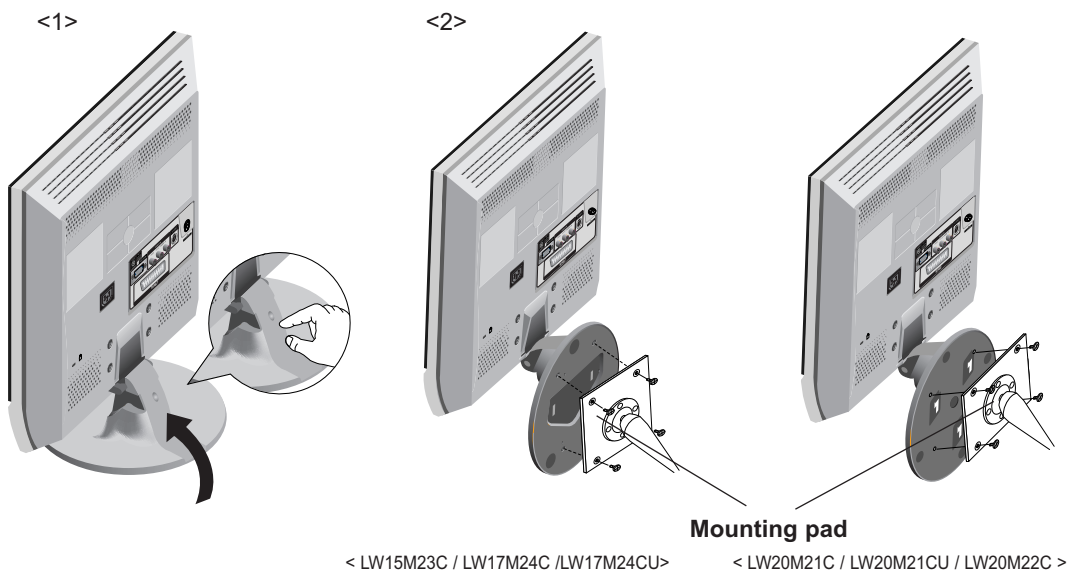

<1> Fold the stand pressing the button on the back of the stand.

<2> Align the mounting interface pad with the holes in the stand bottom and secure it with the four screws that come with the arm-type base, wall mount hanger or other bases.

## Installing the Wall Mount Kit (LW15M23C/LW17M24C/LW17M24CU)

Note : This installation is to be used when attaching the wall mount to a concrete wall.  
When attaching to other building materials, please contact your nearest dealer.

### Components

Please use provided components or parts to install the Wall Mount Kit.

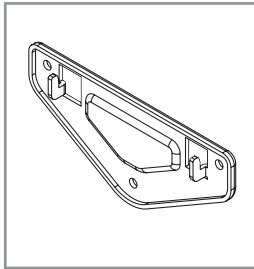

Bracket

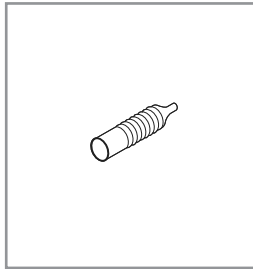

Anchors : 3EA

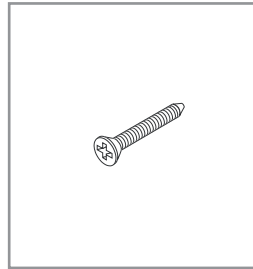

Screws : 3EA

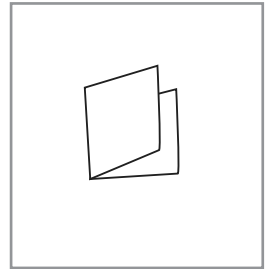

Installation Guide

### How to assemble the Wall Mount Kit

- 1 **1** Mark the location of hole on the wall using installation guide.
- 2 **2** Make over 35mm- depth- hole on the marked location using 5.0-diameter drill.
- 3 **3** Fix anchors on each hole on the wall.
- 4 **4** Connect bracket to the wall with screws after fitting anchors into the bracket holes.

*Note : If the bracket is not firmly fixed to the wall, LCD TV can fall off.*

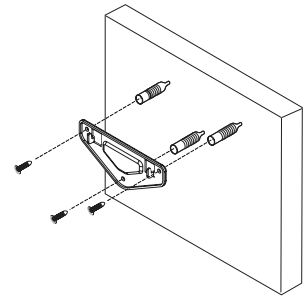

- 2 You may use LCD TV right after fixing it to the wall since stand is wrapped already turned over as shown in the picture below.

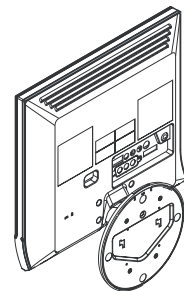

- 3 When using LCD TV in stand-based form, place the product on a cushion or other soft materials. Then turn over stand following the arrow direction below only after pressing button on the connected part where LCD TV is attached to stand.  
(Turn over stand in the opposite direction after pressing button when using LCD TV in wall-mounted form as well.)

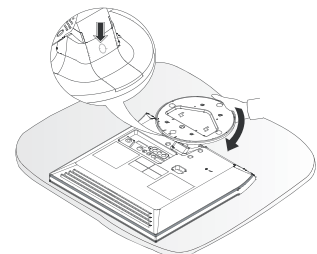

## Installing the Wall Mount Kit (LW15M23C/LW17M24C/LW17M24CU)

- 4 Adjust LCD TV to the hook on the bracket and move in the direction of the arrow(Left) so that LCD TV can be completely fixed to the bracket.

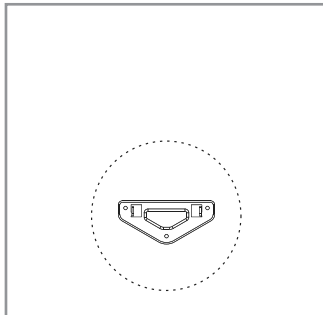

When bracket is assembled on the wall

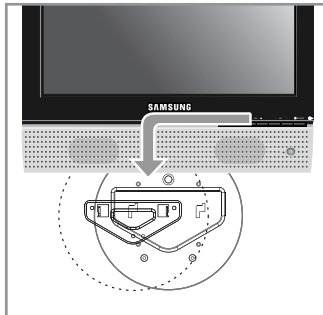

How to hang LCD TV up on a hook

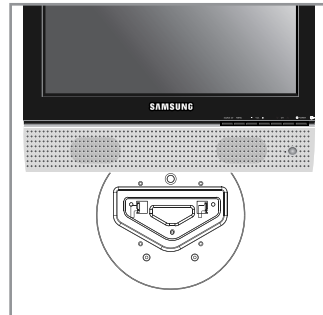

When installation is completed

- 5 Remove Installation Guide after completing setup of monitor on the wall.
- 6 Push the LCD TV up and shift to the right to detach it from bracket. When moving or transferring to other areas, reverse No. 4 procedure so as to disconnect LCD TV with ease.

### How to adjust an angle

(1) Angle adjustment section of general stand-based LCD TV

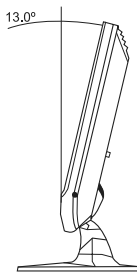

(2) Angle adjustment section while converting the form (1->3, 3->1)

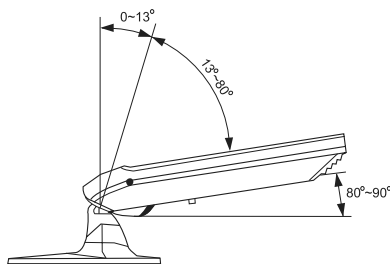

(3) Angle adjustment section of wall-mounted LCD TV

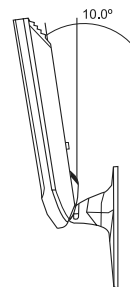

- ❶ Picture(1) shows the adjustment angle(0°~ 13°)when you use LCD TV in its general form(stand-based LCD TV). Excessive tilting can turn LCD TV over which might cause damage to LCD TV.
- ❷ Picture(2) shows the adjustment angle(13°~ 80°)when you convert stand-based LCD TV into wall-mounted one.
- ❸ Picture(3) shows the adjustment angle(0°~ 10°)when you use wall-mounted LCD TV after fixing it to wall.

*Note : Picture (2) shows the angle adjustment section while LCD TV is being converted from stand-based one to wall-mounted one or vice versa.*

*- Click" sound indicates section change from 1 to 2 or 3 to 2(1->2, 3->2).*



# Installing the Wall Mount Kit(LW20M21C/LW20M21CU/LW20M22C)

Note : This installation is to be used when attaching the wall mount to a concrete wall.  
When attaching to other building materials, please contact your nearest dealer.

## Components

Please use provided components or parts to install the Wall Mount Kit.

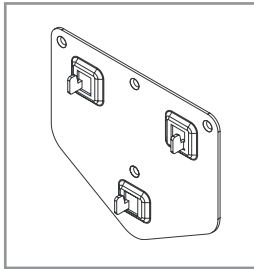

Bracket

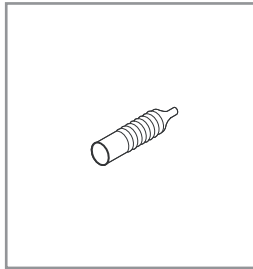

Anchors : 4EA

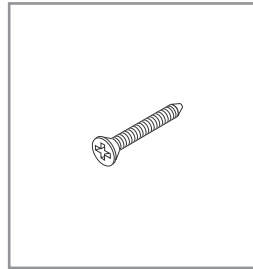

Screws : 4EA

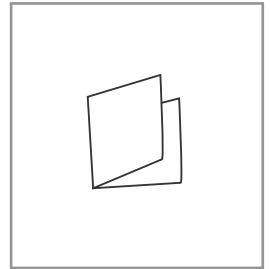

Installation Guide

## How to assemble the Wall Mount Kit

- 1 **1** Mark the location of hole on the wall using installation guide.
- 2 **2** Make over 35mm- depth- hole on the marked location using 5.0-diameter drill.
- 3 **3** Fix anchors on each hole on the wall.
- 4 **4** Connect bracket to the wall with screws after fitting anchors into the bracket holes.

*Note : If the bracket is not firmly fixed to the wall, LCD TV can fall off.*

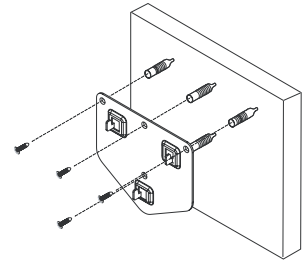

- 2 **2** You may use LCD TV right after fixing it to the wall since stand is wrapped already turned over as shown in the picture below.

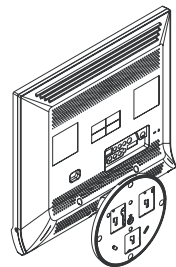

- 3 **3** When using LCD TV in stand-based form, place the product on a cushion or other soft materials. Then turn over stand following the arrow direction below only after pressing button on the connected part where LCD TV is attached to stand.  
(Turn over stand in the opposite direction after pressing button when using LCD TV in wall-mounted form as well.)

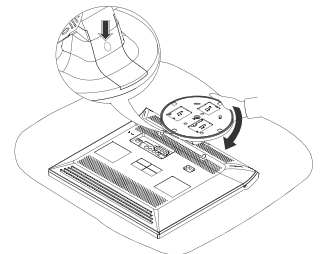

## Installing the Wall Mount Kit(LW20M21C/LW20M21CU/LW20M22C)

- 4 Adjust LCD TV to the hook on the bracket and move in the direction of the arrow(Left) so that LCD TV can be completely fixed to the bracket.

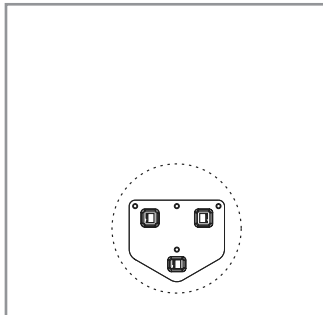

When bracket is assembled on the wall

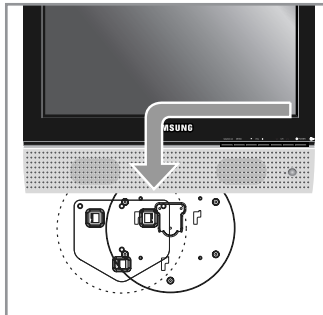

How to hang monitor up on a hook

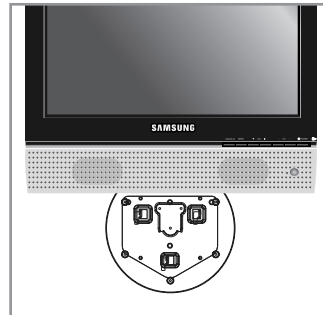

When installation is completed

- 5 Remove Installation Guide after completing setup of LCD TV on the wall.
- 6 Push the LCD TV up and shift to the right to detach it from bracket.  
When moving or transferring to other areas, reverse No. 4 procedure so as to disconnect LCD TV with ease.

### How to adjust an angle

(1) Angle adjustment section of general stand-based LCD TV

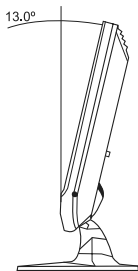

(2) Angle adjustment section while converting the form (1->3, 3->1)

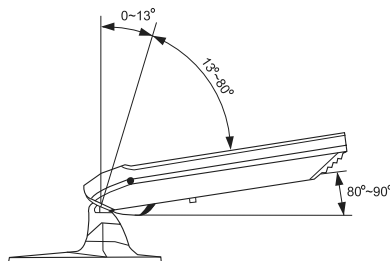

(3) Angle adjustment section of wall-mounted LCD TV

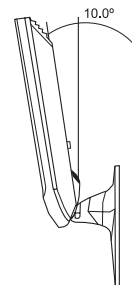

- ❶ Picture(1) shows the adjustment angle(0°~ 13°)when you use LCD TV in its general form(stand-based LCD TV). Excessive tilting can turn LCD TV over which might cause damage to LCD TV.
- ❷ Picture(2) shows the adjustment angle(13°~ 80°)when you convert stand-based LCD TV into wall-mounted one.
- ❸ Picture(3) shows the adjustment angle(0°~ 10°)when you use wall-mounted LCD TV after fixing it to wall.

*Note : Picture (2) shows the angle adjustment section while LCD TV is being converted from stand-based one to wall-mounted one or vice versa.*

# Memo