



SAMSUNG

PDP-TELEVISION (PLASMA DISPLAY PANEL)

Owner's Instructions

Before operating the unit,
please read this manual thoroughly,
and retain it for future reference.

ON-SCREEN MENUS
Picture In Picture (PIP)
Energy Saving

TELETEXT (Option)



SRS TruSurround XT



Digital Natural Image engine

Register your product at www.samsung.com/global/register
Record your Model and Serial number here for future reference.

▪ Model _____ ▪ Serial No. _____

User Instructions

◆ Screen Image retention

Do not display a still image (such as on a video game or when hooking up a PC to this PDP) on the plasma monitor panel for more than 2 hours as it can cause screen image retention. This image retention is also known as "screen burn". To avoid such image retention, reduce the degree of brightness and contrast of the screen when displaying a still image.

◆ Height

The PDP can normally operate only under 2000m in height. It might abnormally function at a place over 2000m in height so do not install and operate there.

◆ Heat on the top of the PDP TV

The top side of the product may be hot after long period of use as heat dissipates from the panel through the vent hole in the upper part of the product. This is normal and does not indicate any defect or operation failure of the product. However, children should be prevented from touching the upper part of the product.

◆ The product is making a 'cracking' noise.

A 'cracking' noise may occur when the product contracts or expands due to a change of surrounding environment such as temperature or humidity. This is normal and not a defect of the unit.

◆ Cell Defects

The PDP uses a panel consisting of 1,230,000(SD-level) to 3,150,000(HD-level) pixels which require sophisticated technology to produce. However, there may be few bright or dark pixels on the screen. These pixels will have no impact on the performance of the product.

◆ Avoid operating the TV at temperatures below 5°C(41°F)

◆ A still image displayed too long may cause permanent damage to the PDP Panel.



Watching the PDP TV in 4:3 format for a long period of time may leave traces of borders displayed on the left, right and centre of the screen caused by the difference of light emission on the screen. Playing a DVD or a game console may cause similar effect to the screen. Damages caused by the above effect are not covered by the Warranty.

◆ Afterimage on the Screen.

Displaying still images from Video games and PC for longer than a certain period of time may produce partial afterimages. To prevent this effect, reduce the 'brightness' and 'contrast' when displaying still images.

◆ Warranty

- Warranty does not cover any damage caused by image retention.
- Burn-in is not covered by the warranty.

◆ Installation

Be sure to contact an authorized service centre, when installing your set in a location with heavy dust, high or low temperatures, high humidity, chemical substance and where it operates continually such as the airport, the train station etc. Failure to do so may cause a serious damage to your set.

Any functions related to Digital TV (DVB) will only work in countries or areas where DVB-T (MPEG2) digital terrestrial signals are broadcasted. Please confirm with your local dealer if you can receive DVB-T signals. Although this TV set follows the DVB-T specification, maintaining compatibility with the future coming DVB-T digital terrestrial broadcasts is not guaranteed. Several functions may not be available in some countries.

Contents

General Information

- ◆ User Instructions 2
- ◆ Checking Parts 4
- ◆ Using the Stand-Base 4
- ◆ Control Panel 5
- ◆ Connection Panel 6
- ◆ Viewing the Remote Control (PS42Q96HD/
PS42Q97HD/PS50Q96HD/PS50Q97HD) 8
- ◆ Viewing the Remote Control (PS42C9HD/
PS42C96HD/PS50C9HD/PS50C96HD) 9

Operation

- ◆ Switching Your Television On and Off 10
- ◆ Viewing the Menus 11
- ◆ Plug & Play Feature 11
- ◆ Viewing an External Signal Sources 13
- ◆ Editing Device Names 14

Channel Control

- ◆ Storing Channels Automatically 14
- ◆ Storing Channels Manually 15
- ◆ Adding / Locking Channels 16
- ◆ Sorting the Stored Channels 17
- ◆ Assigning Names to Channels 17
- ◆ Fine Tuning Channel Reception 18
- ◆ LNA (Low Noise Amplifier) 18

Picture Control

- ◆ Changing the Picture Standard 19
- ◆ Customizing the Picture Settings 19
- ◆ Configuring Detailed Settings on the Picture .. 20
- ◆ Selecting the Picture Size 21
- ◆ Selecting the Screen Mode 21
- ◆ Digital NR / Active Colour / DNle /
Movie Plus 22
- ◆ Freezing the Current Picture 22

Sound Control

- ◆ Sound Features 23
- ◆ Selecting the Sound Mode (depending on
the model) 24

Function Description

- ◆ Time Features 25
- ◆ Language / Blue Screen / Melody /
Light Effect / Energy Saving /
HDMI Black Level 26
- ◆ Using the Game Mode 27
- ◆ Wall- mount adjustment (Sold separately) 28
- ◆ Viewing the Picture in Picture (PIP) 29
- ◆ Screen Burn Protection 30

PC Display

- ◆ Setting up Your PC Software (Based on
Windows XP) 31
- ◆ Input Mode (PC) 32
- ◆ Setting the PC 33
- ◆ Setting the Home Theatre PC 34

Using the DTV Feature

- ◆ Previewing the DTV Menu System 35
- ◆ Displaying Programme Information 36
- ◆ Operating the DTV Menu 37

About Anynet+ (PS42Q96HD/PS42Q97HD/PS50Q96HD/PS50Q97HD)

- ◆ What is Anynet+? 47
- ◆ Connecting Anynet+ Devices 47
- ◆ Setting Up Anynet+ 48
- ◆ Scanning and Switching between Anynet+
Devices 48
- ◆ Recording 49
- ◆ Listening through a Receiver 50
- ◆ Check Points before Requesting Service 50

Appendix

- ◆ Teletext Feature (depending on the model) .. 51
- ◆ Installing the Wall Mount Kit 53
- ◆ Setting Up Your Remote Control 54
- ◆ How to assemble the Stand-Base
(depending on the model) 59
- ◆ Troubleshooting 59
- ◆ Specifications 60

Symbols



Press



Important



Note

Checking Parts

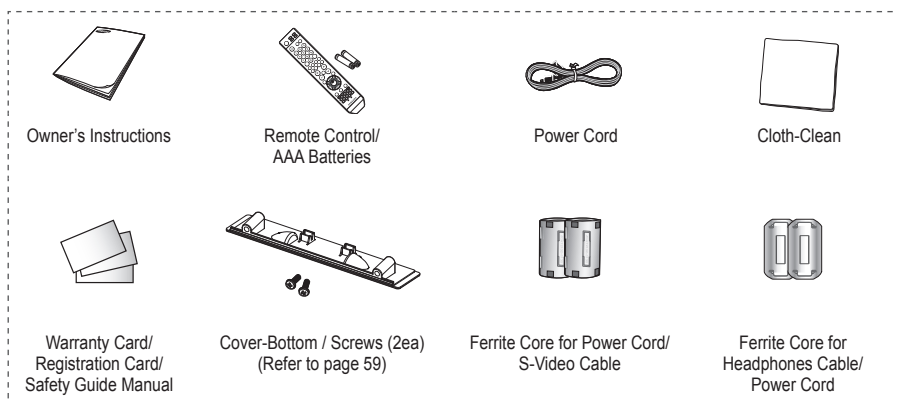

Sold Separately

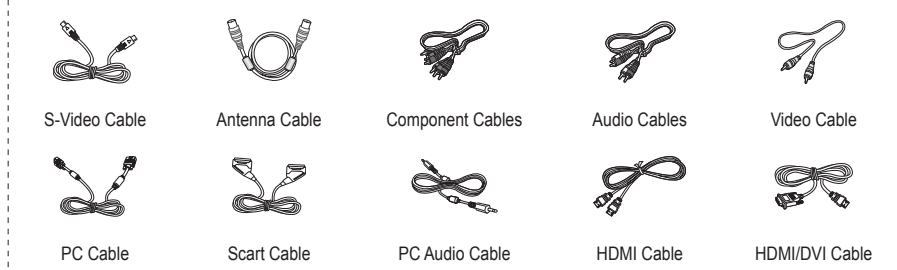

➤ **Ferrite Core (Power Cord, Headphones Cable, S-Video Cable)**

The ferrite core is used to shield the cable from interference. When connecting a cable, open the ferrite core and clip it around the cable.

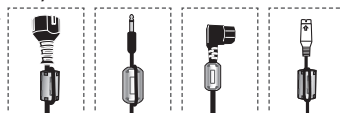

Using the Stand-Base

- ◆ Two or more people should carry the PDP. Never lay the PDP on the floor because of possible damage to the screen. Always keep the PDP upright.
- ◆ The PDP can rotate 20 degrees in right and left directions.

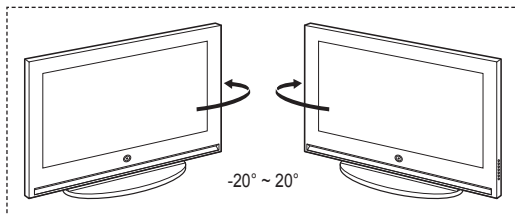

Control Panel

Front (or Side) Panel

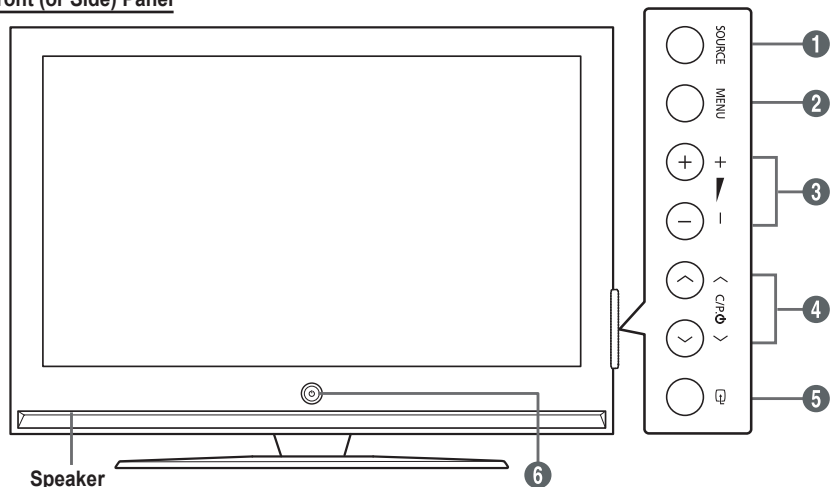

➤ The product colour and shape may vary depending on the model.

1 SOURCE

Displays a menu of all of the available input sources (TV, Ext.1, Ext.2, AV, S-Video, Component, PC, HDMI1, HDMI2, HDMI3, and DTV).

➤ HDMI3 mode is available only in PS42Q96HD/PS42Q97HD/PS50Q96HD/PS50Q97HD models.

2 MENU

Press to see the on-screen menu of your TV's features.

3 + ▴ -

Press to increase or decrease the volume. In the on-screen menu, use the + ▴ - buttons as you use the ◀ and ▶ buttons on the remote control.

4 ^ C/P. P. V ^

Press to change channels. In the on-screen menu, use the ^ C/P. P. V ^ buttons as you use the ▲ and ▼ buttons on the remote control.

5 [ENTER]

Press to confirm a selection.

6 [Power] button

Press to turn the TV on and off.

Power Indicator

- Power Off: Blue
- Power On: Off

Remote Control Sensor

Aim the remote control towards this spot on the TV.

Connection Panel

Side Panel

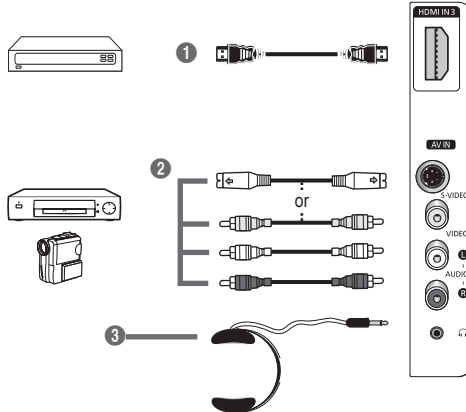

➤ The product colour and shape may vary depending on the model.

- 1 HDMI IN 3 (PS42Q96HD/PS42Q97HD/PS50Q96HD/PS50Q97HD)**
Connect to the HDMI jack of a device with HDMI output.

- 2 S-VIDEO or VIDEO / AUDIO L/R**
Video (S-Video or Video) and audio inputs for external devices, such as a camcorder or VCR.

- 3 Headphones jack**
You can connect a set of headphones if you wish to watch a television programme without disturbing the other people in the room.

➤ Prolonged use of headphones at a high volume may damage your hearing.

Rear Panel

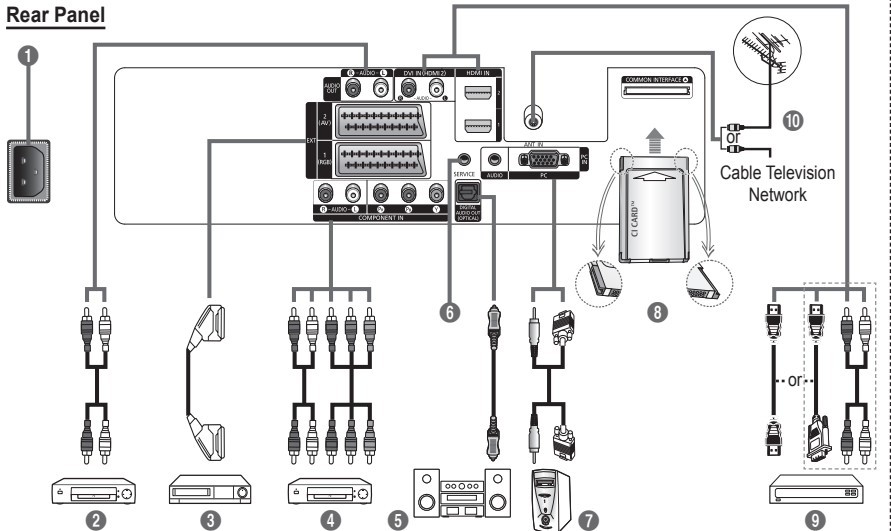

➤ The product colour and shape may vary depending on the model.

- ◆ Whenever you connect an audio or video system to your set, ensure that all elements are switched off.
- ◆ When connecting an external device, match the colour of the connection terminal to the cable.

Continued...

- 1 **POWER IN**
Connect the supplied power cord.
- 2 **Connecting external Audio Devices**
Connect RCA audio signals from the TV to an external source, such as Audio equipment.
- 3 **EXT 1, EXT 2**
Inputs or outputs for external devices, such as VCR, DVD, video game device or video disc players.

Input/Output Specification

Connector	Input			Output
	Video	Audio(L/R)	RGB	Video + Audio(L/R)
EXT 1	✓	✓	✓	Only TV or DTV output is available.
EXT 2	✓	✓		Output you can choose.

- 4 **COMPONENT IN**
Audio (AUDIO L/R) and video (Y/Pb/Pr) inputs for Component.
- 5 **DIGITAL AUDIO OUT (OPTICAL)**
Connect to a Digital Audio Component.
- 6 **SERVICE**
 - Connector for service.
 - Connect the serial jack between the electro-motion wall mount bracket and your TV when you want to adjust the TV viewing angle using your remote control.
- 7 **PC IN / AUDIO**
Connect to the video and audio output jack on your PC.

- 8 **COMMON INTERFACE Slot**
Insert CI (Common Interface) card into the slot. (refer to page 46)
 - When not inserting "CI CARD" in some channels, "Scramble Signal" is displayed on the screen.
 - The pairing information containing a telephone number, CI CARD ID, Host ID, and other information will be displayed in about 2~3 minutes. If an error message is displayed, please contact your service provider.
 - When the channel information configuration has finished, the message "Updating Completed" is displayed, indicating that the channel list is now updated.

➤ Insert the CI-Card in the direction marked on it.

- 9 **HDMI IN 1, HDMI IN 2**
 - Connect to the HDMI jack of a device with HDMI output. These inputs can also be used as a DVI connection with separate analog audio inputs. An optional HDMI/DVI cable will be necessary to make this connection. When using the optional HDMI/DVI adapter, the DVI analog audio inputs on your TV allow you to receive left and right audio from your DVI device. (Not compatible with PC)
 - When connecting this product via HDMI or DVI to a Set Top Box, DVD Player or Games Console etc, make sure that it has been set to a compatible video output mode as shown in the table below. Failure to observe this may result in picture distortion, image breakup or no picture.
 - Do not attempt to connect the HDMI/DVI connector to a PC or Laptop Graphics Card. (This will result in a blank screen being displayed)
- DVI IN (HDMI 2) AUDIO L/R**
DVI audio outputs for external devices.
- 10 **ANT IN**
75Ω Coaxial connector for Aerial/Cable Network.

Supported modes for HDMI and Component

	480i	480p	576i	576p	720p	1080i
HDMI/DVI 50Hz	X	X	X	O	O	O
HDMI/DVI 60Hz	X	O	X	X	O	O
Component	O	O	O	O	O	O

Viewing the Remote Control (PS42Q96HD/PS42Q97HD/PS50Q96HD/PS50Q97HD)

- ◆ This is a special remote control for the visually impaired persons, and has Braille points on the Power, Channel, Volume, STOP, and PLAY/PAUSE buttons.
- ◆ The performance of the remote control may be affected by bright light.

- 1 POWER button (turns the TV on and off)
- 2 Number buttons for direct channel access
- 3 One/Two-digit channel selection
- 4 Channel control button (Refer to page 16)
- 5 Selects the TV and DTV mode directly
- 6 + Volume increase
- Volume decrease
- 7 Temporary sound switch-off
- 8 Displays the main on-screen menu
- 9 Returns to the previous menu
- 12 Picture size selection
- 13 Electronic Program Guide (EPG) display
- 14 Sound mode selection
- 15 Remote control setup
- 16 Selects a target device to be controlled by the Samsung remote control (TV, DVD, STB, CABLE, VCR)
- 17 Press to backlight the VOL, CH, and the active source button (TV, DVD, CABLE, STB, VCR) on the remote.
- 18 Available source selection
- 19 Previous channel
- 20 DTV menu display
- 21 Records for Live Broadcasting
- 22 VCR/DVD Function (Rewind, Stop, Play/Pause, Fast/Forward)
- 23 ⏪ Next channel
⏩ Previous channel
- 24 Exit the on-screen menu
- 25 Control the cursor in the menu
- 26 Use to see information on the current broadcast
- 27 Runs the Anynet+ view functions and sets up Anynet+ devices.
- 28 Picture-In-Picture On/Off
- 29 Picture effect selection (Refer to page 19)
- 30 Digital subtitle display
- 31 Picture freeze
- 32 If your remote control is not functioning properly, take out the batteries and press the reset button for about 2~3 seconds. Re-insert the batteries and try using the remote control again.

Teletext Functions

(Refer to page 51)

- 5 Exit from the teletext display (depending on the model)
- 8 Teletext index
- 10 Fastext topic selection
- 11 Teletext display/mix both teletext information and the normal broadcast
- 12 Teletext size
- 18 Teletext mode selection (LIST/FLOF)
- 19 Teletext sub page
- 23 P ⏪ : Teletext next page
P ⏩ : Teletext previous page
- 24 Teletext cancel
- 26 Teletext reveal
- 28 Teletext hold
- 29 Teletext store

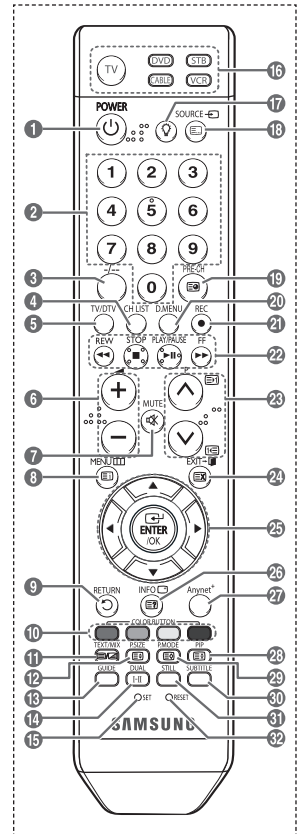

Continued...

Viewing the Remote Control (PS42C9HD/PS42C96HD/PS50C9HD/PS50C96HD)

- ◆ This is a special remote control for the visually impaired persons, and has Braille points on the Power, Channel, Volume, STOP, and PLAY/PAUSE buttons.
- ◆ The performance of the remote control may be affected by bright light.

- 1 POWER button (turns the TV on and off)
- 2 Number buttons for direct channel access
- 3 One/Two-digit channel selection
- 4 Channel control button (Refer to page 16)
- 5 Selects the TV and DTV mode directly
- 6 + Volume increase
- Volume decrease
- 7 Temporary sound switch-off
- 8 Displays the main on-screen menu
- 9 Returns to the previous menu
- 11 TruSurround XT mode button
- 12 Picture size selection
- 13 Electronic Program Guide (EPG) display
- 14 Sound mode selection
- 15 Remote control setup
- 16 Selects a target device to be controlled by the Samsung remote control (TV, DVD, STB, CABLE, VCR)
- 17 Press to backlight the VOL., CH, and the active source button (TV, DVD, CABLE, STB, VCR) on the remote.
- 18 Available source selection
- 19 Previous channel
- 20 DTV menu display
- 21 Selects the HDMI mode directly
- 22 VCR/DVD Function (Rewind, Stop, Play/Pause, Fast/Forward)
- 23 ⏪ Next channel
⏩ Previous channel
- 24 Exit the on-screen menu
- 25 Control the cursor in the menu
- 26 Use to see information on the current broadcast
- 28 Picture-In-Picture On/Off
- 29 Picture effect selection (Refer to page 19)
- 30 Digital subtitle display
- 31 Picture freeze
- 32 If your remote control is not functioning properly, take out the batteries and press the reset button for about 2~3 seconds. Re-insert the batteries and try using the remote control again.

Teletext Functions

(Refer to page 51)

- 5 Exit from the teletext display (depending on the model)
- 8 Teletext index
- 10 Fasttext topic selection
- 12 Teletext size
- 18 Teletext mode selection (LIST/FLOF)
- 19 Teletext sub page
- 23 P ⏪ : Teletext next page
P ⏩ : Teletext previous page
- 24 Teletext cancel
- 26 Teletext reveal
- 27 Teletext display/mix both teletext information and the normal broadcast
- 28 Teletext hold
- 29 Teletext store

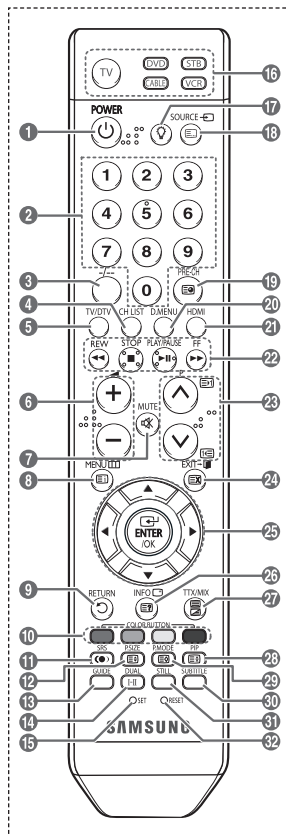

Continued...

Installing Batteries in the Remote Control

- 1 Lift the cover at the back of the remote control upward as shown in the figure.
 - 2 Install two AAA size batteries.
 - ◆ Make sure to match the “+” and “-” ends of the batteries with the diagram inside the compartment.
 - ◆ Do not mix battery types, i.e. alkaline and manganese.
 - 3 Close the cover as shown in the figure.
 - Remove the batteries and store them in a cool and dry place if you won't be using the remote control for a long time. The remote control can be used up to about 23 feet from the TV. (Assuming typical TV usage, the batteries last for about one year.)
- If the remote control doesn't work! Check the following:
1. Is the TV power on?
 2. Are the plus and minus ends of the batteries reversed?
 3. Are the batteries drained?
 4. Is there a power cut, or is the power cord unplugged?
 5. Is there a special fluorescent light or a neon sign nearby?

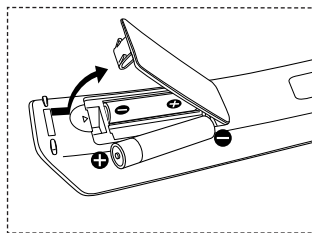

Switching Your Television On and Off

The main lead is attached to the rear of the television.

- 1 Plug the main lead into an appropriate socket.
 - The main voltage is indicated on the rear of the television and the frequency is 50 or 60Hz.
- 2 Press the **⏻** (Power) button (On/Off) on the front of the television or press the **POWER** button on the remote control to switch the television on. The programme that you were watching last is re-selected automatically. If you have not yet stored any channels, no clear picture appears. Refer to “Storing Channels Automatically” on page 14 or “Storing Channels Manually” on page 15.
 - If the television is initially powered on, several basic customer settings proceed automatically. Refer to “Plug & Play Feature” on page 11.
- 3 To switch the television off, press the **⏻** (Power) button (On/Off) on the front of the television or press the **POWER** button on the remote control.
- 4 To switch the TV on, press the **⏻** (Power) button (On/Off) on the front of the TV or press the **POWER** button or number buttons on the remote control.

Viewing the Menus

- 1 Press the **MENU** button.
The main menu is displayed on the screen.
Its left side has five icons: **Picture**, **Sound**, **Channel**, **Setup**, and **Input**.
- 2 Press the **▲** or **▼** button to select one of the icons.
Press the **ENTER/OK** button to access the icon's sub-menu.
- 3 Press the **▲** or **▼** button to move to items in the menu.
Press the **ENTER/OK** button to enter items in the menu.
- 4 Press the **▲/▼/◀/▶** button to change the selected items.
Press the **RETURN** button to return to the previous menu.
- 5 Press the **EXIT** button to exit from the menu.

- The illustration for remote control and OSD (On Screen Display) shown in this manual has been created based on the PS42Q96HD model. Even though the configuration is different from your model, the operation method is the same as in the illustration.

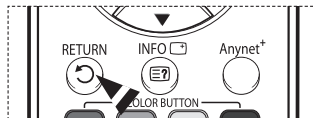
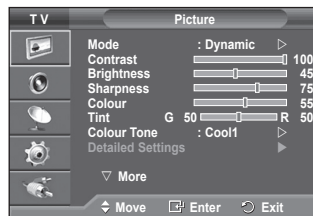

Plug & Play Feature

When the television is initially powered on, several basic customer settings proceed automatically and subsequently. The following settings are available.

- ☛ If you accidentally select the wrong country for your TV, the characters on the screen may be wrongly displayed.
 - ☛ Any functions related to Digital TV (DVB) will only work in countries or areas where DVB-T (MPEG2) digital terrestrial signals are broadcasted. Please confirm with your local dealer if you can receive DVB-T signals. Although this TV set follows the DVB-T specification, maintaining compatibility with the future coming DVB-T digital terrestrial broadcasts is not guaranteed. Several functions may not be available in some countries.
- 1 If the television is in standby mode, press the **POWER** button on the remote control. The message **Start Plug & Play** is displayed. Press the **ENTER/OK** button.
 - 2 The **Language** menu will automatically appear after several seconds.
 - 3 Select the appropriate language by pressing the **▲** or **▼** button. Press the **ENTER/OK** button. The message **Select Home Mode when installing this TV at home** is displayed.
 - 4 Press the **◀** or **▶** button to select **Shop** or **Home**, then press the **ENTER/OK** button. The message to check the connected status of the antenna is displayed.
 - The default selection is **Home**.
 - We recommend setting the TV to Home mode for the best picture in your home environment.
 - Shop mode is only intended for use in retail environments.
 - If the unit is accidentally set to Shop mode, and you want to return to Dynamic (Home) mode, press the Volume button and then hold down the **MENU** button for five seconds on the TV panel.
 - 5 Make sure that the antenna is connected to the TV. Press the **ENTER/OK** button. The **Country** menu is displayed.

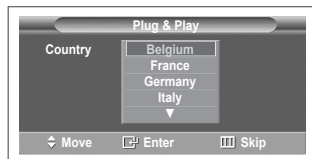
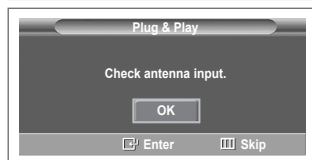

Continued...

- 6 Select your country or area by pressing the ▲ or ▼ button. Press the **ENTER/OK** button. The message **Some DTV functions may not be available. Digitally Scan?** is displayed. If your country supports the DTV functions, the message is not displayed. Then you can follow the instructions from step 12. When the local service provider does not support DTV broadcasting but you choose a DTV supporting country, it enters the DTV Plug & Play but DTV functions may not work properly. When **No** is selected, follow the instructions from step 7 to 10. When **Yes** is selected, follow the instructions from step 11.
- 7 Select **No** pressing the ◀ or ▶ button, then press the **ENTER/OK** button. **Auto Store** menu is displayed.
- 8 Press the **ENTER/OK** button to start search the channels. The channel search will start and end automatically. After all the available channels are stored, **Clock Set** menu is automatically displayed. Press the **ENTER/OK** button.
 - To stop the search before it has finished, press the **ENTER/OK** button with **Stop** selected.
- 9 Press the ◀ or ▶ button to select **Month, Day, Year, Hour, or Minute**. Set these by pressing the ▲ or ▼ button.
 - You can set the **Month, Day, Year, Hour, or Minute** directly by pressing the numeric buttons on the remote control.
- 10 Press the **ENTER/OK** button to confirm your setting. The message **Enjoy your viewing** is displayed. When you have finished, press the **ENTER/OK** button.
 - Even if the **ENTER/OK** button is not pressed, the message will automatically disappear after several seconds.
- 11 Select **Yes** pressing the ◀ or ▶ button, then press the **ENTER/OK** button. **Auto Store** menu is displayed.
- 12 Press the **ENTER/OK** button to start search the analog channels. The analog channel search will start and end automatically. After all the available analog channels are stored, the screen for searching digital channels is automatically displayed.
 - To stop the search before it has finished, press the **ENTER/OK** button with **Stop** selected.
- 13 Press the **ENTER/OK** button to start search the digital channels. The digital channel search will start and end automatically. After all the available digital channels are stored, the screen to select a time zone is displayed depending on the country.
 - To stop the search before it has finished, press the **ENTER/OK** button with **Stop** selected.
 - If the DTV channel is updated, the Source in the source list of the Input menu is automatically changed to DTV.
 - For detailed descriptions about DTV channel update, refer to page 37 of this manual.
- 14 Press the ▲ or ▼ button to select required time zone, then press the **ENTER/OK** button. The screen for setting the time is displayed. Press the **ENTER/OK** button.

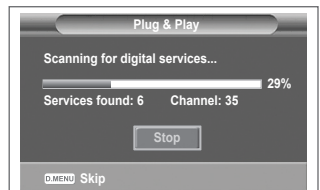
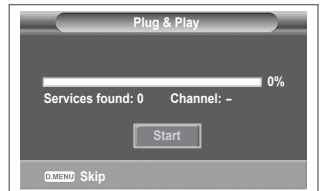
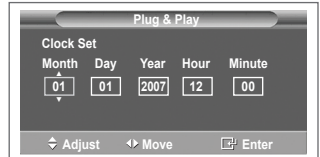

Continued...

- 15 Press the ◀ or ▶ button to select **Month, Day, Year, Hour, or Minute**. Set these by pressing the ▲ or ▼ button.
 - You can set the **Month, Day, Year, Hour, or Minute** directly by pressing the numeric buttons on the remote control.
- 16 Press the **ENTER/OK** button to confirm your setting. The message **Enjoy your viewing** is displayed. When you have finished, press the **ENTER/OK** button.
 - Even if the **ENTER/OK** button is not pressed, the message will automatically disappear after several seconds.

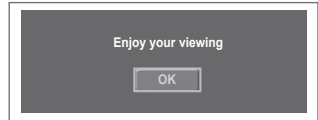
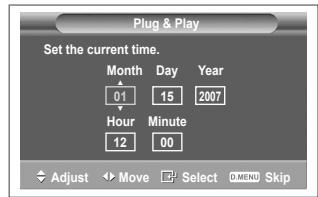

If you want to reset this feature ...

- 1 Press the **MENU** button to display the menu.
- 2 Press the ▲ or ▼ button to select **Setup**, then press the **ENTER/OK** button.
- 3 Press the **ENTER/OK** button again to select **Plug & Play**. The message **Start Plug & Play** is displayed.



Viewing an External Signal Sources

You can switch between viewing signals from connected equipment, such as a VCR, DVD, Set-Top Box, and the TV source (broadcast or cable).

- 1 Press the **MENU** button to display the menu.
- 2 Press the ▲ or ▼ button to select **Input**, then press the **ENTER/OK** button.
- 3 Press the **ENTER/OK** button again to select **Source List**.
- 4 Press the ▲ or ▼ button to select the signal source, then press the **ENTER/OK** button.

Available signal sources: **TV, Ext.1, Ext.2, AV, S-Video, Component, PC, HDMI1, HDMI2, HDMI3, DTV**

- HDMI3 mode is available only in PS42Q96HD/PS42Q97HD/PS50Q96HD/PS50Q97HD models.



- You can select these options simply by pressing the **SOURCE** button on the remote control.

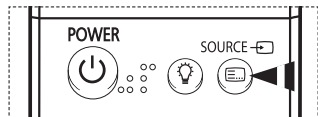

- To watch television programme again, press the **TV/DTV** button and select the channel number required.

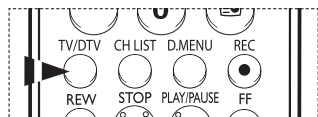

Editing Device Names

You can give a name to the external source.

- 1 Press the **MENU** button to display the menu.
- 2 Press the **▲** or **▼** button to select **Input**, then press the **ENTER/OK** button.
- 3 Press the **▲** or **▼** button to select **Edit Name**, then press the **ENTER/OK** button.
- 4 Press the **▲** or **▼** button to select the external source to be edited, then press the **ENTER/OK** button.
- 5 Select the required device by pressing **▲** or **▼**, then press the **ENTER/OK** button.

Available device names: **VCR, DVD, D-VHS, Cable STB, HD STB, Satellite STB, AV Receiver, DVD Receiver, Game, Camcorder, DVD Combo, DHR (DVD HDD Recorder), PC.**

- 6 Press the **EXIT** button to exit.
 - HDMI3 mode is available only in PS42Q96HD/PS42Q97HD/PS50Q96HD/PS50Q97HD models.

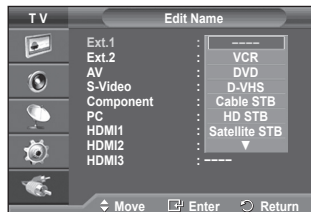

Storing Channels Automatically

➤ Not available in DTV or external input mode.
 You can scan for the frequency ranges available to you (availability depends on your country).

Automatically allocated programme numbers may not correspond to actual or desired programme numbers. However you can sort numbers manually and clear any channels you do not wish to watch.

- 1 Press the **MENU** button to display the menu.
- 2 Press the **▲** or **▼** button to select **Channel**, then press the **ENTER/OK** button.
- 3 Press the **ENTER/OK** button again. The available countries are listed.
- 4 Select your country by pressing the **▲** or **▼** button, then press the **ENTER/OK** button.
 - Even though you have changed the country setting in this menu, the country setting for DTV is not changed. Use the Plug & Play function to change the country setting for DTV. (Refer to page 11 to 13)
- 5 Press the **▲** or **▼** button to select **Auto Store**, then press the **ENTER/OK** button.
- 6 Press the **ENTER/OK** button again to start the search. The search will end automatically.
 - To stop the search before it has finished, press the **MENU** or the **ENTER/OK** button.



Storing Channels Manually

➤ Not available in DTV or external input mode.

You can store television channels, including those received via cable networks.

When storing channels manually, you can choose:

- ◆ Whether or not to store each of the channels found.
 - ◆ The programme number of each stored channel which you wish to identify.
- 1 Press the **MENU** button to display the menu.
 - 2 Press the **▲** or **▼** button to select **Channel**, then press the **ENTER/OK** button.
 - 3 Press the **▲** or **▼** button to select **Manual Store**, then press the **ENTER/OK** button.
 - 4 Select the required option by pressing the **▲** or **▼** button, then press the **ENTER/OK** button.
 - 5 When you are satisfied with your setting, press the **ENTER/OK** button.
 - 6 Press the **EXIT** button to exit.
- ◆ **Programme** (Programme number to be assigned to a channel)
 - Press the **▲** or **▼** button until you find the correct number.
 - You can also select the channel number directly by pressing the numeric buttons (0~9).
 - ◆ **Colour System: Auto/PAL/SECAM/NTSC4.43**
 - Press the **▲** or **▼** button to select the required colour standard.
 - ◆ **Sound System: BG/DK/I/L**
 - Press the **▲** or **▼** button to select the required sound standard.
 - ◆ **Channel** (When you know the number of the channel to be stored)
 - Press the **▲** or **▼** button to select **C** (Air channel) or **S** (Cable channel).
 - Press the **▶** button, then press the **▲** or **▼** button to select the required number.
 - You can also select the channel number directly by pressing the numeric buttons (0~9).
 - If there is abnormal sound or no sound, re-select the sound standard required.
 - ◆ **Search** (When you do not know the channel numbers)
 - Press the **▲** or **▼** button to start the search.
 - The tuner scans the frequency range until the first channel or the channel that you selected is received on the screen.
 - ◆ **Store** (When you store the channel and associated programme number)
 - Set to **OK** by pressing the **ENTER/OK** button.
- Channel mode**
- ◆ **P** (Programme mode): When completing tuning, the broadcasting stations in your area have been assigned to position numbers from P00 to P99. You can select a channel by entering the position number in this mode.
 - ◆ **C** (Air channel mode): You can select a channel by entering the assigned number to each air broadcasting station in this mode.
 - ◆ **S** (Cable channel mode): You can select a channel by entering the assigned number for each cable channel in this mode.

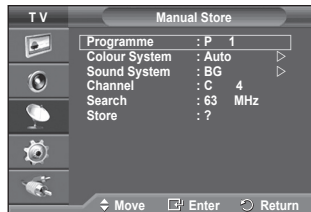

Adding / Locking Channels

➤ Not available in DTV or external input mode.

Using the Channel Manager, you can conveniently lock or add channels.

- 1 Press the **MENU** button to display the menu.
- 2 Press the **▲** or **▼** button to select **Channel**, then press the **ENTER/OK** button.
- 3 Press the **▲** or **▼** button to select **Channel Manager**, then press the **ENTER/OK** button.

◆ Adding channels

Using the Channel List, you can add channels.

- 4 Select **Channel List** by pressing the **ENTER/OK** button.
- 5 Move to the **(+)** field by pressing the **▲/▼/◀/▶** buttons, select a channel to be added, and press the **ENTER/OK** button to add the channel.
 - If you press the **ENTER/OK** button again, the **(✓)** symbol next to the channel disappears and the channel is not added.

◆ Locking channels

This feature allows you to prevent unauthorized users, such as children, from watching unsuitable programmes by muting out video and audio.

- 6 Press the **▲** or **▼** button to select **Child Lock**, then press the **ENTER/OK** button.
 - 7 Select **On** by pressing the **▲** or **▼** button, then press the **ENTER/OK** button.
 - 8 Press the **▲** or **▼** button to select **Channel List**, then press the **ENTER/OK** button.
 - 9 Move to the **(🔒)** field by pressing the **▲/▼/◀/▶** buttons, select a channel to be locked, and press the **ENTER/OK** button.
 - If you press the **ENTER/OK** button again, the **(✓)** symbol next to the channel disappears and the channel lock is canceled.
 - A blue screen is displayed when Child Lock is activated.
 - 10 Press the **EXIT** button to exit.
- You can select these options simply by pressing the **CH LIST** button on the remote control.

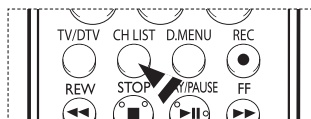
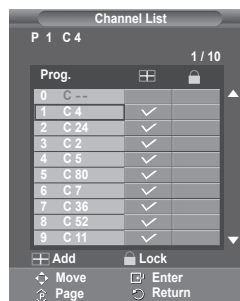

Sorting the Stored Channels

➤ Not available in DTV or external input mode.

This operation allows you to change the programme numbers of the stored channels.

This operation may be necessary after using the auto store.

- 1 Press the **MENU** button to display the menu.
- 2 Press the **▲** or **▼** button to select **Channel**, then press the **ENTER/OK** button.
- 3 Press the **▲** or **▼** button to select **Sort**, then press the **ENTER/OK** button.
- 4 Select the channel that you wish to move by pressing the **▲** or **▼** button, then press the **ENTER/OK** button.
- 5 Select the number of the programme to which the channel is to be moved by pressing the **▲** or **▼** button. Press the **ENTER/OK** button. The channel is moved to its new position and all other channels are shifted accordingly.
- 6 Repeat steps 4 to 5 until you have moved all the channels to the required programme numbers.
- 7 Press the **EXIT** button to exit.

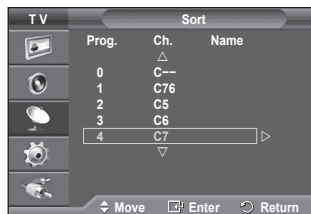

Assigning Names to Channels

➤ Not available in DTV or external input mode.

Channel names will be assigned automatically when channel information is broadcast. These names can be changed, allowing you to assign new names.

- 1 Press the **MENU** button to display the menu.
- 2 Press the **▲** or **▼** button to select **Channel**, then press the **ENTER/OK** button.
- 3 Press the **▲** or **▼** button to select **Name**, then press the **ENTER/OK** button.
- 4 Press the **▲** or **▼** button to select the channel to be assigned to a new name, then press the **ENTER/OK** button.
- 5 Press the **▲** or **▼** button to select a letter, a number, or a symbol (Results in this sequence: A~Z, 0~9, +, -, *, /, blank). Move on to the previous or next letter by pressing the **◀** or **▶** button, then press the **ENTER/OK** button.
- 6 Repeat steps 4 to 5 for each channel to be assigned to a new name.
- 7 Press the **EXIT** button to exit.

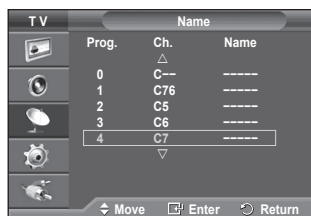

Fine Tuning Channel Reception

➤ Not available in DTV or external input mode.

If the reception is clear, you do not have to fine tune the channel, as this is done automatically during the search and store operation.

If the signal is weak or distorted, you may have to fine tune the channel manually.

- 1 Press the **MENU** button to display the menu.
- 2 Press the **▲** or **▼** button to select **Channel**, then press the **ENTER/OK** button.
- 3 Press the **▲** or **▼** button to select **Fine Tune**, then press the **ENTER/OK** button.
- 4 To obtain a sharp, and clear picture and good sound quality, press the **◀** or **▶** button until you reach the optimal setting. Press the **ENTER/OK** button.
 - To reset the fine tuning to **0**, select **Reset** by pressing the **▲** or **▼** button. Press the **ENTER/OK** button.
- 5 Press the **EXIT** button to exit.
 - Fine Tune Store will change the colour of the Channel OSD (On Screen Display) from White to Red and add the ****** mark.

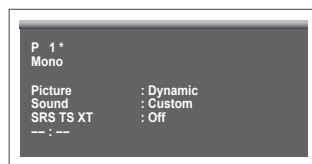
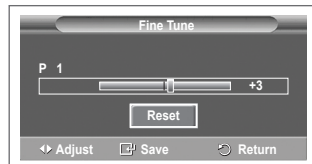

LNA (Low Noise Amplifier)

This function is very useful in the situation that the TV is used in weak signal.

LNA amplifies the TV signal in the weak signal area, a low-noise preamplifier boosts the incoming signal.

- 1 Press the **MENU** button to display the menu.
- 2 Press the **▲** or **▼** button to select **Channel**, then press the **ENTER/OK** button.
- 3 Press the **▲** or **▼** button to select **LNA**, then press the **ENTER/OK** button.
- 4 Select **Off** or **On** by pressing the **▲** or **▼** button, then press the **ENTER/OK** button.
- 5 Press the **EXIT** button to exit.
 - Depending on areas, factory mode of LNA, will be set up as On or Off.



Changing the Picture Standard

You can select the type of picture which best corresponds to your viewing requirements.

- 1 Press the **MENU** button to display the menu.
- 2 Press the **ENTER/OK** button to select **Picture**.
- 3 Press the **ENTER/OK** button again to select **Mode**.
- 4 Select the required mode by pressing the **▲** or **▼** button, then press the **ENTER/OK** button.
Available modes: **Dynamic**, **Standard**, **Movie**
 - The settings values may vary depending on the input source. (ex. RF, Video, Component, PC, or HDMI)
- 5 Press the **EXIT** button to exit.

- You can select these options simply by pressing the **P.MODE** button on the remote control.
- - ◆ Choose **Dynamic** for viewing the TV during the day or when there is bright light in the room.
 - ◆ Choose **Standard** for general TV watching mode.
 - ◆ Choose **Movie** when viewing the movie.

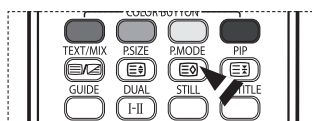
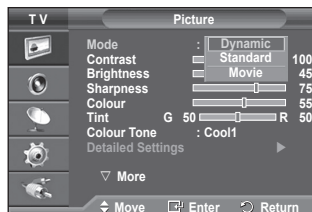
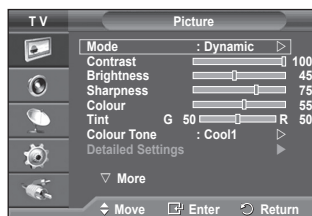

Customizing the Picture Settings

Your television has several setting options that allow you to control the picture quality.

- 1 Press the **MENU** button to display the menu.
- 2 Press the **ENTER/OK** button to select **Picture**.
- 3 Press the **ENTER/OK** button again to select **Mode**.
- 4 Select the required mode by pressing the **▲** or **▼** button, then press the **ENTER/OK** button.
Available modes: **Dynamic**, **Standard**, **Movie**
- 5 Select the required option by pressing the **▲** or **▼** button, then press the **ENTER/OK** button.
- 6 When you are satisfied with your setting, press the **ENTER/OK** button.
- 7 Press the **EXIT** button to exit.

- ◆ **Contrast – Brightness – Sharpness – Colour – Tint**
 - In TV, AV, S-Video modes of the PAL system, you cannot use the Tint Function.

Contrast – Brightness – Colour Tone : PC Mode

Press the **◀** or **▶** button until you reach the optimal setting.

- ◆ **Colour Tone: Cool2/Cool1/Normal/Warm1/Warm2**
 - When the picture mode is set to **Dynamic** or **Standard**, **Warm1** and **Warm2** cannot be selected.
- ◆ **Reset: Cancel/OK**
 - Select **OK**. You can return to the factory defaults picture settings.
 - The reset function is set for each picture mode and colour tone.

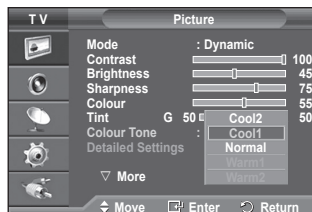
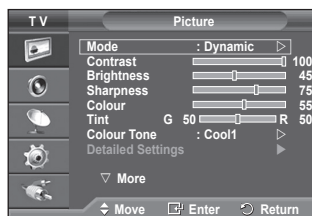

Configuring Detailed Settings on the Picture

You can set detailed picture settings.

- 1 Press the **MENU** button to display the menu.
- 2 Press the **ENTER/OK** button to select **Picture**.
- 3 Press the **▲** or **▼** button to select **Detailed Settings**, then press the **ENTER/OK** button.
- 4 Select the required option by pressing the **▲** or **▼** button, then press the **ENTER/OK** button.

Available options: **Black Adjust**, **Dynamic Contrast**, **Gamma**, **White Balance**, **My Colour Control**, **Edge Enhancement**, **Colour Space**

- 5 When you are satisfied with your setting, press the **ENTER/OK** button.
- 6 Press the **EXIT** button to exit.

➤ When the picture mode is set to **Movie** or **Standard**, **Detailed Settings** can be selected.

➤ If **DNIe** is Off, the **Detailed Settings** cannot be selected when the Picture mode is in **Standard** mode.

◆ **Black Adjust: Off/Low/Medium/High**

You can directly select the black level on the screen to adjust the screen depth.

◆ **Dynamic Contrast: Off/Low/Medium/High**

You can adjust the screen contrast so that the optimal contrast is provided.

◆ **Gamma: -3 ~ +3**

You can adjust the middle brightness of pictures.

Press the **◀** or **▶** button until you reach the optimal setting.

◆ **White Balance: R-Offset/G-Offset/B-Offset/R-Gain/G-Gain/B-Gain/Reset**

You can adjust the color temperature for more natural picture colors.

R-Offset/G-Offset/B-Offset/R-Gain/G-Gain/B-Gain: Changing the adjustment value will refresh the adjusted screen.

Select the required option by pressing the **▲** or **▼** button, then press the **ENTER/OK** button. Press the **◀** or **▶** button until you reach the optimal setting.

Reset: The previously adjusted white balance will be reset to the factory defaults.

◆ **My Colour Control: Pink/Green/Blue/White/Reset**

This setting can be adjusted to suit your personal preferences.

Pink/Green/Blue/White: Changing the adjustment value will refresh the adjusted screen.

Select the required option by pressing the **▲** or **▼** button, then press the **ENTER/OK** button. Press the **◀** or **▶** button until you reach the optimal setting.

Reset: The previously adjusted colours will be reset to the factory defaults.

◆ **Edge Enhancement: Off/On**

You can emphasize object boundaries.

◆ **Colour Space: Auto/Wide**

You can set the colour reproduction space for the input signal to Auto or Wide.

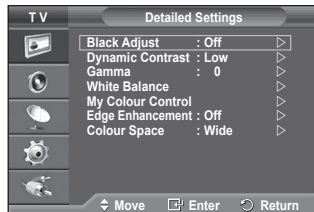
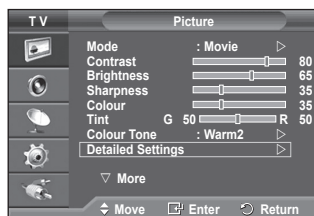

Selecting the Picture Size

You can select the picture size which best corresponds to your viewing requirements.



- 1 Press the **MENU** button to display the menu.
- 2 Press the **ENTER/OK** button to select **Picture**.
- 3 Press the **▲** or **▼** button to select **Size**, then press the **ENTER/OK** button.
- 4 Select the required option by pressing the **▲** or **▼** button, then press the **ENTER/OK** button.

Available options: **Auto Wide**, **16:9**, **Wide Zoom**, **Zoom**, **4:3**, **Just Scan**

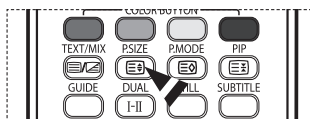
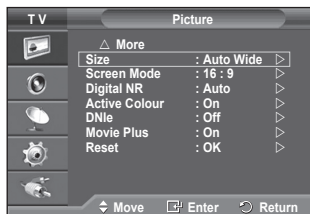
- ◆ **Auto Wide**: Expanding and pulling up the picture from 4:3 to 16:9 ratio.
 - ◆ **16:9**: Sets the picture to 16:9 wide mode.
 - ◆ **Wide Zoom**: Magnify the size of the picture more than 4:3. Move the screen up/down using the **▲** or **▼** button after selecting the  by pressing the **▶** or **ENTER/OK** button.
 - ◆ **Zoom**: Magnify the size of the picture vertically on screen.
 - ◆ **4:3**: Sets the picture to 4:3 normal mode.
 - ◆ **Just Scan**: Displays the input scenes as they are without any cutoff when HDMI 720p, 1080i signals are input.
 - With the HDMI Just Scan picture size, depending on the AV devices, the screen may be cut off or a specific colour appears on the screen.
- 5 Press the **EXIT** button to exit.
 - You can change the picture size simply by pressing the **P.SIZE** button on the remote control.
 - Depending on the input source, the picture size options may vary.
 - The items available may differ depending on the selected mode.



Positioning and Sizing the screen using Zoom

- ◆ Resizing the screen using the **Zoom** enables the positioning and sizing of the screen to up/down direction using the **▲** or **▼** button as well as the screen size.
- ◆ Move the screen up/down using the **▲** or **▼** button after selecting the  by pressing the **◀** or **▶** button.
- ◆ Resize the screen vertically using the **▲** or **▼** button after selecting the  by pressing the **◀** or **▶** button.

Selecting the Screen Mode

When setting the picture size to Auto Wide in a 16:9 wide TV, you can determine the picture size you want to see the 4:3 WSS (Wide Screen Service) image or nothing. Each individual European country requires different picture size so this function is intended for users to select it.

- 1 Press the **MENU** button to display the menu.
- 2 Press the **ENTER/OK** button to select **Picture**.
- 3 Press the **▲** or **▼** button to select **Screen Mode**, then press the **ENTER/OK** button.
- 4 Select the required option by pressing the **▲** or **▼** button, then press the **ENTER/OK** button.

Available options: **16:9**, **Wide Zoom**, **Zoom**, **4:3**

- ◆ **16:9**: Sets the picture to 16:9 wide mode.
 - ◆ **Wide Zoom**: Magnify the size of the picture more than 4:3.
 - ◆ **Zoom**: Magnify the size of the picture vertically on screen.
 - ◆ **4:3**: Sets the picture to 4:3 normal mode.
- 5 When you are satisfied with your setting, press the **ENTER/OK** button.
 - 6 Press the **EXIT** button to exit.

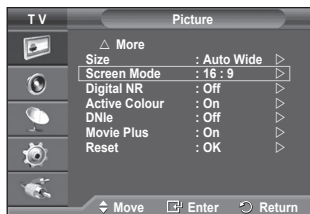

Digital NR / Active Colour / DNle / Movie Plus

- 1 Press the **MENU** button to display the menu.
- 2 Press the **ENTER/OK** button to select **Picture**.
- 3 Select the required option by pressing the **▲** or **▼** button, then press the **ENTER/OK** button.

Available options: **Digital NR**, **Active Colour**, **DNle**, **Movie Plus**

- 4 When you are satisfied with your setting, press the **ENTER/OK** button.
- 5 Press the **EXIT** button to exit.

◆ **Digital NR: Off/Low/Medium/High/Auto**

If the signal received by the television is weak, you can activate this feature to reduce any static and ghosting that may appear on the screen.

◆ **Active Colour: Off/On**

If you turn on this option, the colors of the sky and grass will be stronger and clearer for a more vivid on-screen picture.

- This function is not available in PC mode.
- This function is not available in Movie and Standard mode.

◆ **DNle: Off/Demo/On**

This TV includes the DNle function so as to provide a high visual quality. If you set DNle to on, you can view the screen with the DNle feature activated. If you set the DNle to Demo, you can view the applied DNle and normal pictures on the screen, for demonstration purposes. Using this function, you can view the difference in the visual quality.

➤ **DNle™ (Digital Natural Image engine) [DNle]**

This feature brings you more detailed image with 3D noise reduction, detail enhancement, contrast enhancement and white enhancement. New image compensation Algorithm gives brighter, clearer, more detailed image to you. DNle™ technology will fit every signal into your eyes.

- This function is not available in PC mode.

◆ **Movie Plus: Off/On (PS42Q96HD/PS42Q97HD/PS50Q96HD/PS50Q97HD)**

You can view more natural skin and clear text even in fast moving scenes.

- The Wide Zoom, Zoom and Just Scan mode is not supported.

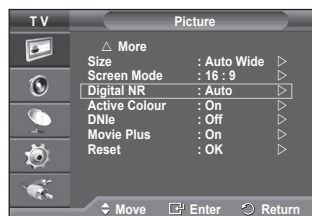

Freezing the Current Picture

You can freeze the picture when watching a television programme simply by pressing the “STILL” button. To return to normal viewing, press it again.

- This function will automatically cancel five minutes later.

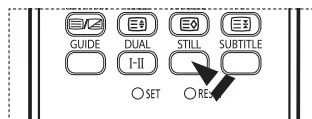

Sound Features

- 1 Press the **MENU** button to display the menu.
- 2 Press the **▲** or **▼** button to select **Sound**, then press the **ENTER/OK** button.
- 3 Select the required option by pressing the **▲** or **▼** button, then press the **ENTER/OK** button.
Available options: **Mode**, **Equalizer**, **SRS TS XT**, **Auto Volume**, **Internal Mute**, **Reset** (If Game Mode is On)

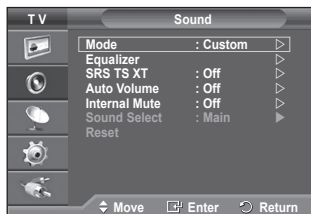

- 4 When you are satisfied with your setting, press the **ENTER/OK** button.
- 5 Press the **EXIT** button to exit.

◆ **Mode: Standard/Music/Movie/Speech/Custom**
You can select the type of special sound effect to be used when watching a given broadcast.

◆ **Equalizer: Balance/100Hz/300Hz/1kHz/3kHz/10kHz**
The television has several settings which allow you to control the sound quality.

➤ If you make any changes to these settings, the sound mode is automatically switched to **Custom**.

◆ **SRS TS XT: Off/On**
TruSurround XT is a patented SRS technology that solves the problem of playing 5.1 multichannel content over two speakers. TruSurround delivers a compelling, virtual surround sound experience through any two-speaker playback system, including internal television speakers. It is fully compatible with all multichannel formats.

➤ TruSurround XT, SRS and  Symbol are trademarks of SRS Labs, Inc. TruSurround XT technology is incorporated under license from SRS Labs, Inc.



➤ You can select these options simply by pressing the **SRS** button on the remote control. (PS42C9HD/PS42C96HD/PS50C9HD/PS50C96HD)

◆ **Auto Volume: Off/On**

Each broadcasting station has its own signal conditions, and so it is not easy to adjust the volume every time the channel is changed. This feature lets you automatically adjust the volume of the desired channel by lowering the sound output when the modulation signal is high or by raising the sound output when the modulation signal is low.

◆ **Internal Mute: Off/On**

If you want to hear the sound through separate speakers, cancel the internal amplifier.

➤ The **▲**+, **▲**- and **MUTE** buttons do not operate when the Internal Mute is set to On.

◆ **Sound Select: Main/Sub**

When the PIP feature is activated, you can listen to the sound of the sub (PIP) picture.

- **Main:** Used to listen to the sound of the main picture.
- **Sub:** Used to listen to the sound of the sub picture.

◆ **Reset**

If Game Mode is On, the Reset Sound function is activated. Selecting the Reset function after setting the equalizer resets the equalizer setting to the factory defaults.

< If Game Mode is On >

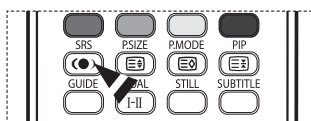
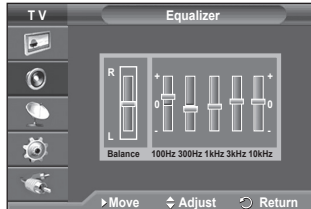
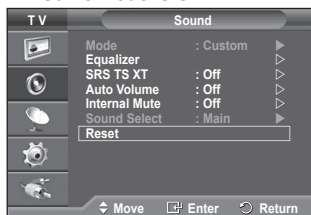

TRADEMARK & LABEL LICENSE NOTICE



Manufactured under license from Dolby Laboratories.
“Dolby” and the double-D symbol are trademarks of Dolby Laboratories.

Selecting the Sound Mode (depending on the model)

The DUAL I-II button displays/controls the processing and output of the audio signal. When power is switched on, the mode is automatically preset to either “DUAL-I” or “Stereo”, depending on the current transmission.

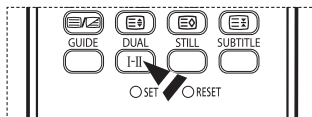

	Type of broadcast	On-screen indication		
NICAM Stereo	Regular broadcast (Standard audio)	Mono (Normal use)		
	Regular + NICAM Mono	NICAM	↔	Mono (Normal)
	NICAM Stereo	NICAM stereo	↔	Mono (Normal)
	NICAM DUAL-I/II	NICAM dual-1	→ NICAM dual-2 →	Mono (Normal)
A2 Stereo	Regular broadcast (Standard audio)	Mono (Normal use)		
	Bilingual or DUAL-I/II	Dual I	↔	Dual II
	Stereo	Stereo	↔	Mono (Forced mono)

- ◆ If the receiving conditions deteriorate, listening will be easier if the mode is set to **Mono**.
- ◆ If the stereo signal is weak and automatic switching occurs, switch to **Mono**.
- ◆ When receiving a mono sound in the AV mode, connect to the “AUDIO-L” input connector on the panel (front or side). If the mono sound comes out only from left speaker, press the **DUAL I-II** button.

Time Features

- 1 Press the **MENU** button to display the menu.
- 2 Press the **▲** or **▼** button to select **Setup**, then press the **ENTER/OK** button.
- 3 Press the **▲** or **▼** button to select **Time**, then press the **ENTER/OK** button.
- 4 Select the required option by pressing the **▲** or **▼** button, then press the **ENTER/OK** button.
Available options: **Clock Set**, **Sleep Timer**, **Timer 1**, **Timer 2**, **Timer 3**
- 5 When you are satisfied with your setting, press the **ENTER/OK** button.
- 6 Press the **EXIT** button to exit.

◆ Clock Set

You can set the television clock so that the current time is displayed when pressing the **INFO** button on the remote control. You must also set the time if you wish to use the automatic on or off timers.

- Press the **◀** or **▶** button to select **Month**, **Day**, **Year**, **Hour**, or **Minute**. Set these by pressing the **▲** or **▼** button.
- You can set the **Month**, **Day**, **Year**, **Hour**, or **Minute** directly by pressing the numeric buttons on the remote control.
- In the event of a power interruption or the set being turned off at the supply, the settings for the Clock will be lost.

◆ Sleep Timer

You can select a time period of between 30 and 180 minutes after which the television automatically switches to standby mode.

- Select the preset time interval (**Off**, **30**, **60**, **90**, **120**, **150**, or **180**) for staying on by pressing the **▲** or **▼** button.

◆ Timer 1 / Timer 2 / Timer 3

You can set the On/Off timers so that the television will switch on or off automatically at the time you select.

☛ You must set the clock first.

- Press the **◀** or **▶** button to select the required item below. Press the **▲** or **▼** button to adjust to the setting satisfied.

On Time : Select hour, minute, and **No/Yes**. (To activate timer with the setting satisfied, set to **Yes**.)

Off Time : Select hour, minute, and **No/Yes**. (To activate timer with the setting satisfied, set to **Yes**.)

Repeat : Select **Once**, **Everyday**, **Mon~Fri**, **Mon~Sat**, or **Sat~Sun**.

Volume : Select the required volume level.

Programme : Select the required channel.

- You can set the hour, minute, and channel directly by pressing the number buttons on the remote control.

☛ Auto Power Off

When you set the timer "On", the TV will eventually turn off, if no controls are operated for 3 hours after the TV was turned on by timer. This function is only available in timer "On" mode and prevents overheating, which may occur if a TV is on for too long time.

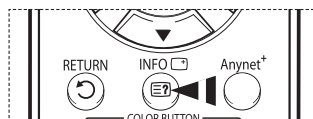
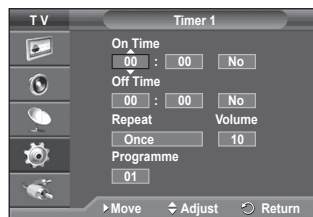
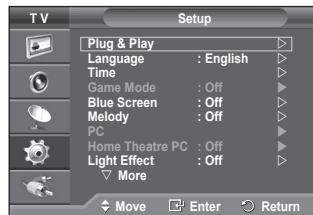

Language / Blue Screen / Melody / Light Effect / Energy Saving / HDMI Black Level

- 1 Press the **MENU** button to display the menu.
- 2 Press the **▲** or **▼** button to select **Setup**, then press the **ENTER/OK** button.
- 3 Select the required option by pressing the **▲** or **▼** button, then press the **ENTER/OK** button.
Available options: **Language, Blue Screen, Melody, Light Effect, Energy Saving, HDMI Black Level**
- 4 When you are satisfied with your setting, press the **ENTER/OK** button.

- 5 Press the **EXIT** button to exit.

◆ Language

It is variable depending on the model. When you start using the television for the first time, you must select the language which will be used for displaying menus and indications.

◆ Blue Screen: On/Off

If no signal is being received or the signal is very weak, a blue screen automatically replaces the noisy picture background. If you wish to continue viewing the poor picture, you must set the Blue Screen to Off.

◆ Melody: Off/Low/Medium/High

The TV power on/off melody sound can be adjusted.

◆ Light Effect: Off/Standby Mode On/Watching Mode On/On

You can turn on/off the blue LED on the front of TV according to the situation. Use it for saving power or when the LED dazzles your eyes.

- **Off:** The blue LED is always off.
- **Standby Mode On:** The blue LED lights while in Standby mode and it turns off when your TV is turned on.
- **Watching Mode On:** The blue LED lights when watching TV and it turns off when your TV is turned off.
- **On:** The blue LED always lights.

➤ Set the Light Effect to Off to reduce the power consumption.

◆ Energy Saving: Off/Low/Medium/High

This feature adjusts the screen brightness depending on the surrounding lighting conditions.

- **Off:** Switches off the Energy Saving mode.
- **Low:** Operates in standard mode regardless of the surrounding illumination.
- **Medium:** Enters Medium power saving mode regardless of the surrounding illumination.
- **High:** Enters maximum power saving mode regardless of the surrounding illumination.

◆ HDMI Black Level: Normal/Low

Using this function, you can adjust the image quality when the screen burn (appearance of black level, low contrast, low color, etc.) is encountered by the HDMI input for RGB limited range (16 to 235).

➤ This function is active only when the external input connects to HDMI(RGB signals).

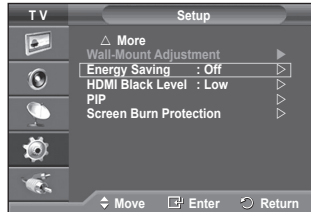
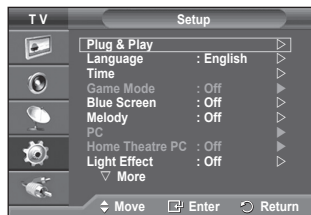

Using the Game Mode

When connecting to a game console such as PlayStation™ or Xbox™, you can enjoy a more realistic gaming experience by selecting game menu.

- 1 Press the **MENU** button to display the menu.
- 2 Press the **▲** or **▼** button to select **Setup**, then press the **ENTER/OK** button.
- 3 Press the **▲** or **▼** button to select **Game Mode**, then press the **ENTER/OK** button.
- 4 Select **Off** or **On** by pressing the **▲** or **▼** button, then press the **ENTER/OK** button.
- 5 Press the **EXIT** button to exit.
 - To disconnect the game console and connect another external device, cancel game mode in the picture menu.
 - If you display the TV menu in Game mode, the screen shakes slightly.
 - Game Mode is not available in TV mode.
 - **If Game Mode is On :**
 - ◆ Picture Mode is automatically changed to Standard and users cannot change the mode.
 - ◆ Sound Mode in the Sound menu is deactivated. Adjust the sound using the equalizer.
 - ◆ The Reset Sound function is activated. Selecting the Reset function after setting the equalizer resets the equalizer setting to the factory defaults.



Wall- mount adjustment (Sold separately)

Once the wall mount is installed, the position of your TV can be easily adjustable.

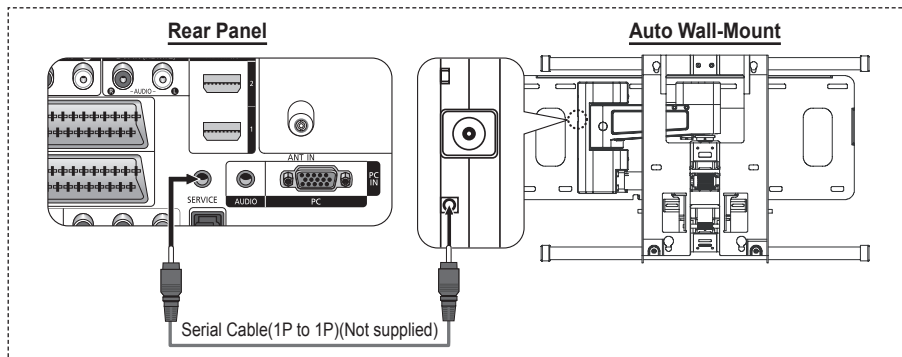

Entering the menu

- 1 Press the **MENU** button to display the menu. Press the **▲** or **▼** button to select **Setup**, then press the **ENTER/OK** button.
 - 2 Press the **▲** or **▼** button to select **Wall-Mount Adjustment**, then press the **ENTER/OK** button.
 - 3 Adjust to the desired position using the **▲/▼/◀/▶** buttons. Press the **EXIT** button to exit.
- (When watching analog broadcasting) If you press an arrow button when no OSD is displayed on the TV screen, the Adjustment screen appears.
 - (When watching digital broadcasting) If you press the **ENTER/OK** button for three seconds when no OSD is displayed on the TV screen, the Adjustment screen appears. (UK only)
 - When you turn the power off, your TV moves to the initial installation position. When you turn the power on, your TV moves to the last remembered position you adjusted.

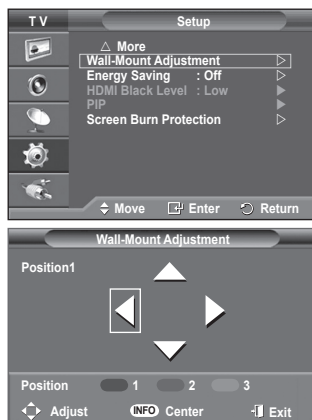

Using the remote Control Buttons

Button	Operations	
	Wall-mount angle adjustment	Tilt Up, Tilt Down, Move right, Move left
	Reset	Moves to the initial installation position
	Remembering the position and moving to the remembered position	Remembers 3 positions with the Red, Green and Yellow buttons. Moves to the remembered position using these 3 color buttons.

- For installation, refer to the Installation Manual provided.
- For product installation and the installation and moving of the wall mount, make sure to consult a specialized installation company.
- This installation manual is to be used when attaching the wall mount to a wall. When attaching to other building materials, please contact your nearest dealer.

Viewing the Picture in Picture (PIP)

You can display a sub picture within the main picture. In this way you can watch TV program or monitor the video input from any connected devices.

- 1 Press the **MENU** button to display the menu.
- 2 Press the **▲** or **▼** button to select **Setup**, then press the **ENTER/OK** button.
- 3 Press the **▲** or **▼** button to select **PIP**, then press the **ENTER/OK** button.
- 4 Select the required option by pressing the **▲** or **▼** button, then press the **ENTER/OK** button.

Available options: **PIP(On/Off)**, **Source**, **Size**, **Position**, **Programme**

- 5 When you are satisfied with your setting, press the **ENTER/OK** button.
- 6 Press the **EXIT** button to exit.

◆ PIP: On/Off

You can activate or deactivate the PIP function.

➤ You can select these options simply by pressing the **PIP** button on the remote control.

◆ Source: TV/Ext.1/Ext.2/AV

You can select a source of the sub-picture.

◆ Size: / /

You can select a size of the sub-picture.

➤ If main picture is in **PC** and **Component** mode, **Size** is not available.

◆ Position: / / /

You can select a position of the sub-picture.

◆ Programme

You can select a channel of the sub-picture only when the **Source** is set to **TV**.

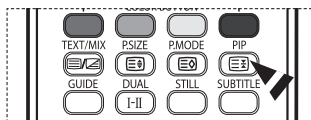
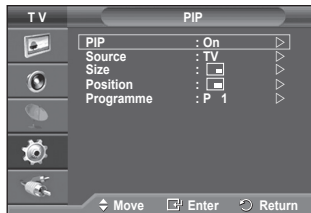
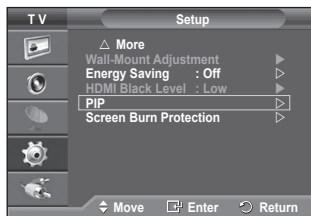

Table of PIP Settings

X - This PIP combination is not available.

O - This PIP combination is available.

Main \ Sub	TV analog	Ext.1	Ext.2	AV	S-Video	Component	HDMI	PC	TV digital
Component	O	O	O	O	X	X	X	X	X
HDMI	O	O	O	O	X	X	X	X	X
PC	O	O	O	O	X	X	X	X	X

Screen Burn Protection

To reduce the possibility of screen burn, this unit is equipped with screen burn prevention technology. This technology enables you to set picture movement up/down (Vertical Line) and side to side (Horizontal Dot). The Time setting allows you to program the time between movement of the picture in minutes.

- 1 Press the **MENU** button to display the menu.
- 2 Press the **▲** or **▼** button to select **Setup**, then press the **ENTER/OK** button.
- 3 Press the **▲** or **▼** button to select **Screen Burn Protection**, then press the **ENTER/OK** button.
- 4 Select the required option by pressing the **▲** or **▼** button, then press the **ENTER/OK** button.

Available options: **Pixel Shift**, **All White**, **Signal Pattern**, **Side Gray**

- 5 When you are satisfied with your setting, press the **ENTER/OK** button.
- 6 Press the **EXIT** button to exit.

◆ **Pixel Shift:** Using this function, you can minutely move pixels on the PDP in horizontal or vertical direction to minimize after image on the screen.

- Set **Pixel Shift** to **On** by pressing the **▲** or **▼** button, then press the **ENTER/OK** button.
- Select the required option by pressing the **▲** or **▼** button, then press the **ENTER/OK** button.

Available options: **Horizontal Dot**, **Vertical Line**, **Time**

➤ Optimum condition for pixel shift;

	PC	TV/Ext/AV/S-Video/ Component/HDMI/DTV
Horizontal Dot	1	2
Vertical Line	1	2
Time (minute)	2 min	2 min

➤ The Pixel Shift value may differ depending on the monitor size (inches) and mode.

- ◆ **All White:** This function helps remove after images on the screen by changing the colour of pixels to white. Use this function when there are remaining after images or symbols on the screen especially when you displayed a still image on the screen for a long time.
 - ◆ **Signal Pattern:** This function helps remove after images on the screen by moving all the pixels on the PDP according to a pattern. Use this function when there are remaining after images or symbols on the screen especially when you displayed a still image on the screen for a long time.
 - ◆ **Side Gray:** When you watch TV with the screen ratio of 4:3, the screen is prevented from any damage by adjusting the white balance on both extreme left and right sides.
Dark: When you set the screen ratio to 4:3, it darkens the left and right sides.
Light: When you set the screen ratio to 4:3, it brightens the left and right sides.
- To remove after images on the screen, use either **All White** or **Signal Pattern** function. Although both of the two functions remove after images on the screen, **Signal Pattern** is more effective.
- The after image removal function has to be executed for a long time (approximately 1 hour) to effectively remove after images on the screen. If after image is not improved after the execution of the function, repeat the function again.
- Press any button on the remote control to cancel this feature.

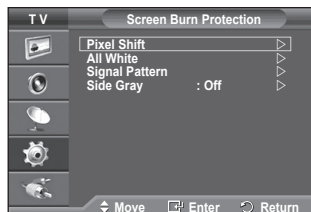
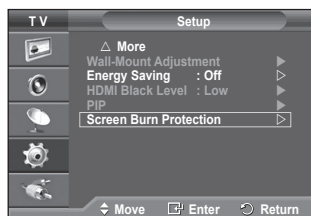

Setting up Your PC Software (Based on Windows XP)

The Windows display-settings for a typical computer are shown below. But the actual screens on your PC will probably be different, depending upon your particular version of Windows and your particular video card. But even if your actual screens look different, the same, basic set-up information will apply in almost all cases. (If not, contact your computer manufacturer or Samsung Dealer.)

- 1 Right click the mouse on the Windows Desktop, then click on **Properties**.
The **Display Properties** will be displayed.
- 2 Click on **Settings tab**, then set the Display Mode with reference to the Display Modes Table. You do not need to change the Colours settings.
- 3 Click on **Advanced**. A new settings dialog box will be displayed.
- 4 Click on the **Monitor tab**, then set the **Screen refresh rate** with reference to the Display Modes Table. Set the Vertical Frequency and Horizontal Frequency individually if you can do so instead of setting the **Screen refresh rate**.
- 5 Click on **OK** to close the window, then Click on **OK** button to the **Display Properties** window. Automatic re-booting may commence at this moment.



Input Mode (PC)

Both screen position and size will vary depending on the type of PC monitor and its resolution. The table below shows all of the display modes that are supported:

Video Signal	Resolution (Dot X Line)	Vertical frequency (Hz)	Horizontal frequency (kHz)	Vertical polarity	Horizontal polarity	PS42Q96HD/ PS42Q97HD/ PS42C9HD/ PS42C96HD	PS50Q96HD/ PS50Q97HD/ PS50C9HD/ PS50C96HD
IBM PC / AT Compatible	640 x 350	70.086	31.469	N	P	✓	✓
	720 x 400	70.087	31.469	P	N	✓	✓
	640 x 480	59.940	31.469	N	N	✓	✓
		70.000	35.000	N/P	N/P	✓	✓
		72.809	37.861	N	N	✓	✓
	800 x 600	75.000	37.500	N	N	✓	✓
		60.317	37.879	P	P	✓	✓
		70.000	43.750	N/P	N/P	✓	✓
		72.188	48.077	P	P	✓	✓
	1024 x 768	75.000	46.875	P	P	✓	✓
		60.004	48.363	N	N	✓	✓
		70.069	56.476	N	N	✓	✓
		72.000	57.672	N/P	N/P	✓	✓
	1360 x 768	75.029	60.023	P	P	✓	✓
	1360 x 768	60.015	47.712	P	P		✓

(N: Negative / P: Positive)

- ◆ The interlace mode is not supported.
- ◆ The television might operate abnormally if a non-standard video format is selected.
- ◆ 480i/p, 576i/p, 720p, or 1080i is not available in PC mode.
- ◆ For the PS42Q96HD/PS42Q97HD/PS42C9HD/PS42C96HD, PC text quality is optimum in **XGA** mode (1024 x 768@60Hz).
- ◆ For the PS50Q96HD/PS50Q97HD/PS50C9HD/PS50C96HD, PC text quality is optimum in **WXGA** mode (1360 x 768@60Hz).
(The three pixels each on the left and right are grayed at the resolution setting of 1360 x 768@60Hz. This is not a mechanical problem but a result caused by the pixel difference between the standard resolution and the PDP panel.)

Setting the PC

- Preset to the **PC** mode by pressing the **SOURCE** button.
- 1 Press the **MENU** button to display the menu.
 - 2 Press the **▲** or **▼** button to select **Setup**, then press the **ENTER/OK** button.
 - 3 Press the **▲** or **▼** button to select **PC**, then press the **ENTER/OK** button.
 - 4 Select the required option by pressing the **▲** or **▼** button, then press the **ENTER/OK** button.

Available options: **Image Lock, Position, Auto Adjustment, Image Reset**

- 5 When you are satisfied with your setting, press the **ENTER/OK** button.

- 6 Press the **EXIT** button to exit.

◆ **Image Lock: Coarse/Fine**

The purpose of picture quality adjustment is to remove or reduce picture noise.

If the noise is not removed by Fine-tuning alone, then adjust the frequency as best as possible (coarse) and Fine-tune again.

After the noise has been reduced, re-adjust the picture so that it is aligned on the center of screen.

- 1 Press the **▲** or **▼** button to select **Coarse** or **Fine**, then press the **ENTER/OK** button.
- 2 Press the **◀** or **▶** button to adjust the screen quality, vertical stripes may appear or the picture may be blurry. Press the **ENTER/OK** button.

◆ **Position**

Adjust the PC's screen positioning if it does not fit the TV screen.

- 1 Adjust the position by pressing the **▲/▼/◀/▶** button.
- 2 Press the **ENTER/OK** button.

◆ **Auto Adjustment**

Auto adjustment allows the PC screen of set to self-adjust to the incoming PC video signal.

The values of fine, coarse and position are adjusted automatically.

◆ **Image Reset**

You can replace all image settings with the factory default values.

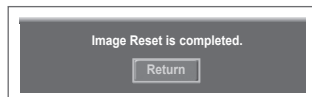
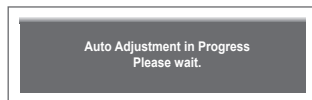
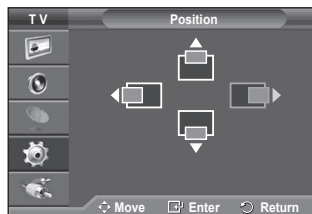
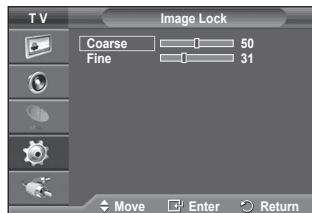
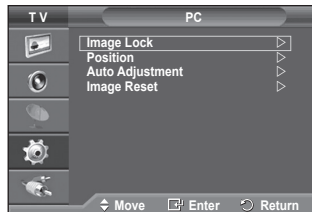

Setting the Home Theatre PC

You can view higher quality pictures by configuring the screen settings in PC Mode.

If you set the Home Theatre PC function to On, you can configure the Detailed Settings (when Picture Mode is set to Standard or Movie) as in PC Mode.

- 1 Press the **MENU** button to display the menu.
 - 2 Press the **▲** or **▼** button to select **Setup**, then press the **ENTER/OK** button.
 - 3 Press the **▲** or **▼** button to select **Home Theatre PC**, then press the **ENTER/OK** button.
 - 4 Select **Off** or **On** by pressing the **▲** or **▼** button, then press the **ENTER/OK** button.
 - 5 Press the **EXIT** button to exit.
- This function is available only in PC mode.



Previewing the DTV Menu System

- ◆ The company does not guarantee the normal operation of the DTV menu for countries other than the 6 supported countries (England, Germany, France, Italy, Spain, Austria) because only these country standards are supported. In addition, when the country of the broadcast stream differs from the country selected by the current user, the string appearing in the channel banner, Info, Guide, Channel List, etc. may not be displayed properly.
- ◆ Available in DTV mode. Preset to the DTV mode by using the **TV/DTV** button on your remote control. To help you navigate around the on-screen menu system and adjust the various settings available, refer to the following illustration.

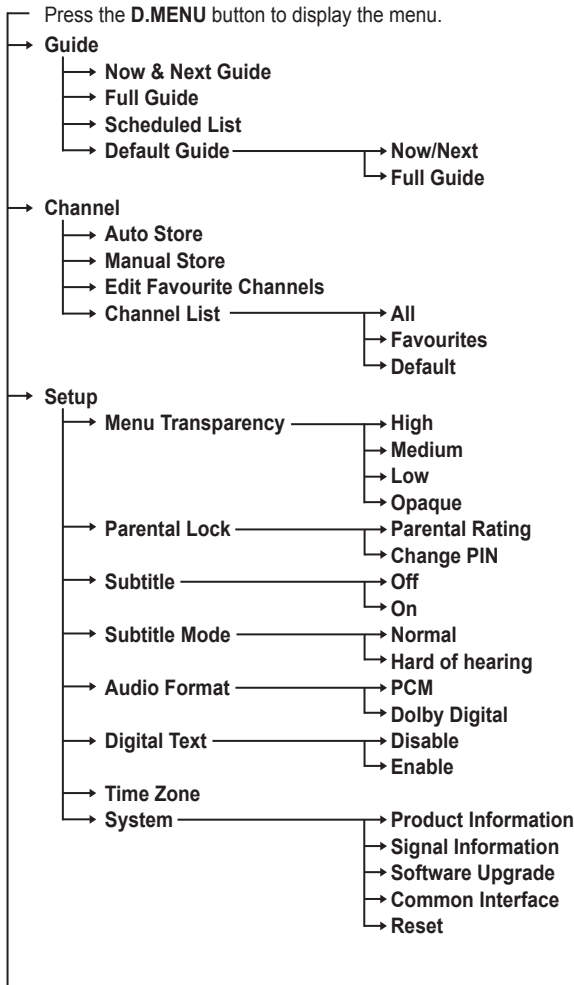
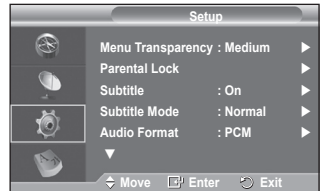
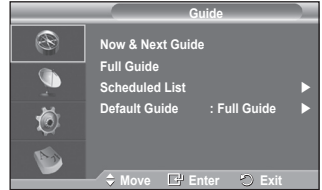
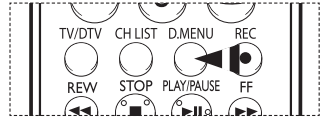

Continued...

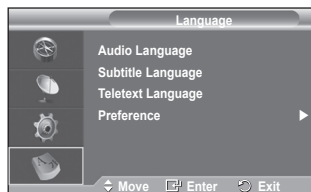
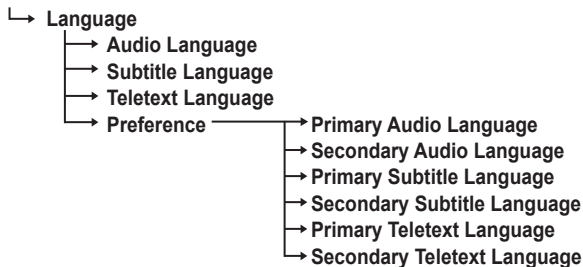

➤ The sub-items of the CI Menu may vary depending on the CAM model. (refer to page 46)

Displaying Programme Information

While viewing a channel, additional information about the current programme may be displayed.

- ◆ While viewing a programme, press the **INFO** button. The programme information is displayed.
 - The information is displayed:
 - Parental Rating
 - Video Type: SD, HD, Radio
 - Audio Type: Mono, Stereo, Dual, Dolby Digital
 - Existence of Teletext or DVB Subtitle
 - Audio Language
 - To exit from banner information, press the **INFO** button.

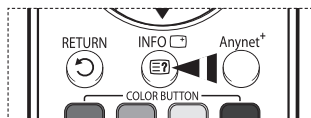

Operating the DTV Menu

Viewing the DTV Menu

After installing your antenna system and TV with appropriate connectors.

- ◆ Plug in the AC main power and switch on the TV.
- ◆ Press the **D.MENU** button to bring up the DTV menu. The main menu appears on the screen. Its left side has four icons: **Guide**, **Channel**, **Setup**, and **Language**.

1. Channel

This menu consists of 4 sub-menus:

Auto Store, **Manual Store**, **Edit Favourite Channels**, and **Channel Manger**.

- ◆ Press the **▲** or **▼** button to select **Channel**, then press the **ENTER/OK** button. The Channel menu is displayed.

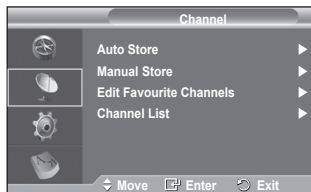

1.1 Auto Store

You can update the channel list when the broadcaster adds new services or if you move the TV to a new location.

- ◆ Press the **ENTER/OK** button to select **Auto Store**. Press the **ENTER/OK** button again to start the search. When it has finished, the number of scanned services will be displayed.
 - The existing favourite channel list will not be deleted when the channel list is updated.
 - To stop the scan before it has finished, press the **ENTER/OK** button with **Stop** selected.
- If the signal status is poor, **No service found! Check the aerial connection.** message is displayed.

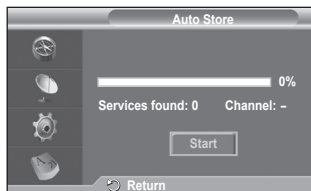
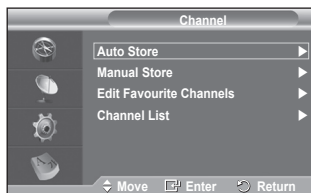

1.2 Manual Store

You can specify the channel for a fast channel search.

- ◆ - **Channel**
 - Press the **▲**, **▼** or numeric buttons (0~9) to select a channel. The available channels are 21~68. The corresponding frequency for the selected channel is automatically set.
- **Frequency**
 - You can specify the frequency (KHz) using the numeric buttons (0~9). If you do not know the exact frequency, follow the above step to select the frequency automatically using channel.
- **Bandwidth**
 - Press the **▲** or **▼** button to select a bandwidth. The available bandwidths are 7 and 8 MHz.
- ◆ Press the red button to start the scan for digital services. When it has finished, channels are updated in the channel list.
- You can input by pressing the button on the remote control.
- You can not change only frequency and when changing a channel the Frequency will be automatically changed.

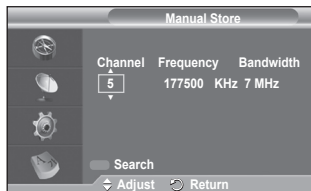
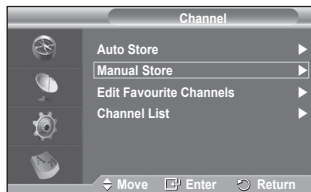

Continued...

1.3 Edit Favourite Channels

You can edit your favourite channels using the colour buttons.

➤ In the case of DTV mode, **OK** or **Select** can be used as the **ENTER/OK** button.

- ◆ Press the red button in the Edit Favourite Channels menu to display all currently stored channels.
- ◆ Press the ▲ or ▼ button to select a channel you want. Press the **ENTER/OK** button. A "★" icon is shown next to the selected channel and the channel will be added to the favourites list.
 - ◆ To undo, press the **ENTER/OK** button again.
 - ◆ **Select All**: Select all channels currently displayed.
 - ◆ **Select None**: Deselect all selected channels.
 - ◆ **Preview**: Displays (a) currently selected channel(s).
 - If The Favourite Channels settings have been completed.

◆ Add

You can use this function when one or more favourite channels have been selected.

- Press the red button in the **Edit Favourite Channels** menu. To add more channels, refer to the previous section.
- To add all channels to the favourites channel list, press the red button.
- To remove all channels, press the green button.
- **Preview**: Displays (a) currently selected channel(s).
- Press the **CH LIST** button to display the favourite channel list.

◆ Move

- In the Edit Favourite Channels menu, press the ▲ or ▼ button to select the required channel.
- Press the green button. A ◆ icon is displayed on the left side of the channel name.
- Press the ▲ or ▼ button to select the channel that you want to move, then press the green or **ENTER/OK** button. The channel is moved to its new position.

◆ Preview

- In the **Edit Favourite Channels** menu, press the ▲ or ▼ button to select the channel to be previewed.
- Press the yellow button. Displays currently selected channel.

◆ Delete

- In the **Edit Favourite Channels** menu, press the ▲ or ▼ button to select the channel to be deleted from the favourite channels list.
- Press the blue button. The selected channel and number will be deleted.
- To add a deleted channel back in to the favourite channel list, see **Add**.

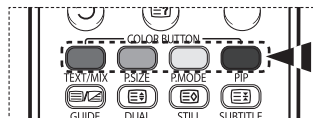
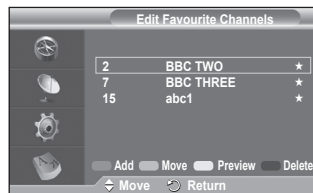
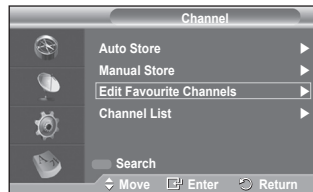

Continued...

1.4 Channel List

You can display a list of all channels or your favourite channels.

- ◆ Press the ▲ or ▼ button to select **Channel List**, then press the **ENTER/OK** button.
 - It can be displayed simply by pressing the **CH LIST** button.
- ◆ Press the yellow button to toggle between your favourite channels and all channels. Your favourite channels are only displayed if they were previously set in the **Edit Favourite Channels** menu (refer to page 38).
- ◆ Press the red or green button to display the previous or next channel list page.
- ◆ Press the ▲ or ▼ button to select a channel to be tuned, then press the **ENTER/OK** button.
 - The channel number, name and an icon are displayed in the top left corner while changing the channel. The channel number and name are displayed if the channel is one of the all channels, and a ★ icon if the channel is one of the favourite channels.
- ◆ Press the blue or **CH LIST** button to exit from the channel list.

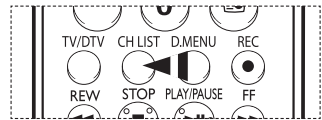

2. Guide

This menu consists of 4 sub-menus:

Now & Next Guide, Full Guide, Scheduled List, and Default Guide.

2.1 Now & Next Guide / Full Guide

The EPG (Electronic Programme Guide) information is provided by the broadcasters. Programme entries may appear blank or out of date as a result of the information broadcast on a given channel.

The display will dynamically update as soon as new information becomes available.

- Now & Next Guide

For the six channels indicated in the left-hand column, displays the Current programme and the Next programme information.

- Full Guide

Displays the programme information as time ordered 30 minute segments. One and half hours of programme information is displayed which may be scrolled forwards or backwards in time.

- ◆ Press the ▲ or ▼ button to select **Now & Next Guide** or **Full Guide**. Press the **ENTER/OK** button. The selected guide menu is displayed.
 - Press the red button to toggle between **Now & Next Guide** or **Full Guide**.
 - Press the green button to display **Favourites** or **All Channels** list.
 - Press the yellow button to scrolls backwards quickly (24 hours).
 - Press the blue button to scrolls forwards quickly (24 hours).
 - You can also display the guide menu simply by pressing the **GUIDE** button.
- ◆ To watch a programme in the EPG list, press the ▲/▼/◀/▶ button to select a programme of your choice, then press the **ENTER/OK** button.
 - If the next programme is selected, it is scheduled with the clock icon displayed. If the **ENTER/OK** button is pressed again, the scheduling is canceled with the clock icon gone. For details about scheduling programmes, refer to the section.

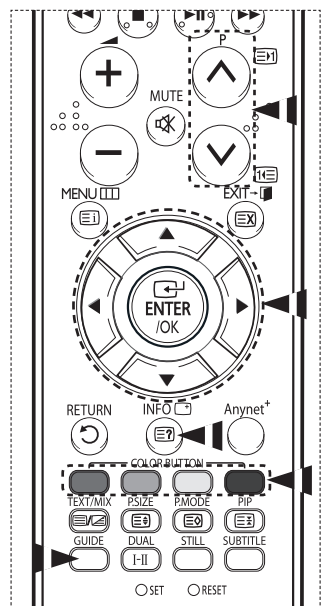

Continued...

- ◆ To view programme information, press the ▲/▼/◀/▶ button to select a programme of your choice, then press the **INFO** button.
 - ◆ Information such as the channel number, programme title and running time, status bar, and brief summary of the highlighted programme will be displayed in the top right corner of the screen. If there is a lengthy summary, "..." will be displayed. Press the **INFO** button for the full summary text.
 - ◆ Six channels are displayed. To scroll between channels, move to a channel using the ▲ or ▼ button. To display page by page, use the P◀ or ▶ button.

2.2 Scheduled List

If you make a scheduled viewing list of programs you may like to see, the channel will be automatically switched to the scheduled program at the scheduled time even if you are watching another program.

- ◆ Press the red button to add a new programme. The menu for adding a programme is displayed with **Channel** selected.
- ◆ Press the ▲/▼ and **ENTER/OK** buttons to set the required channel, time, date, and frequency. When you are satisfied with your settings, save the adjusted schedule by pressing the red button.
- ◆ If you want to edit the scheduled programme, select a programme by pressing the ▲ or ▼ button, then press the green button. If necessary, select the programme to be deleted by pressing the ▲ or ▼ button, then press the blue button.
 - When watching analog TV, the reserved DTV channel cannot be changed. The channel is only changed automatically to the reserved channel when you are watching DTV.
 - Scheduling programme only functions with the television already turned on, and not from standby mode. For details about switching the television on and off automatically, refer to page 10.

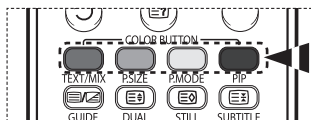
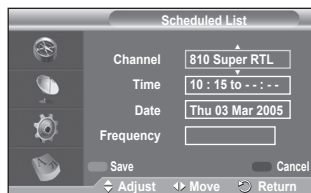

2.3 Default Guide

You can preset the default guide style.

- ◆ Press the ▲ or ▼ button to select the required option (**Now/Next** or **Full Guide**), then press the **ENTER/OK** button. The selected option for default guide is displayed on the EPG menu and the channel list appears.

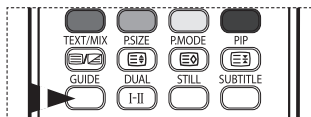
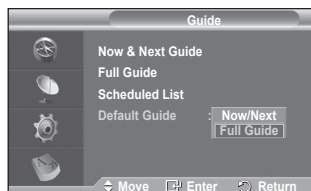
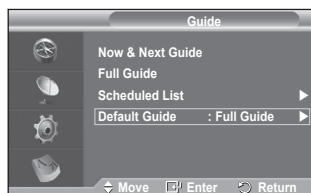

Continued...

2.4 All Channels and Favorite Channels

In the EPG menu, you can display all channels or favourite channels.

- ◆ Press the green button repeatedly to toggle between the all and favourite channels list.

When the favorite channel list has not been set up:

- **The favorite list is empty. Would you like to choose your favorite now?** message is displayed.
- Select **Yes**. The **Edit Favourite Channels** menu is displayed. If you select **No**, all channels will remain unchanged.
- To edit the favourite channels, refer to page 38 for more details.

➤ ◆ **All Channels** is the list of channels that have been scanned by the channel list update. All channels are displayed in the all channel mode.

- ◆ **Favourites** (favourite channels) is the list of channels that has been set in the **Edit Favourite Channels** menu (refer to page 38).

- ◆ When there is no channel information, the **No Data** message will be displayed and you will not be able to change the channel even if you press the **ENTER/OK** button.

When the **No Data** message appears and you cannot change the channel, press the channel number directly using the numeric buttons.

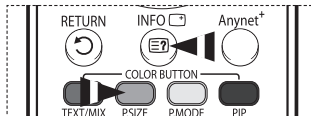
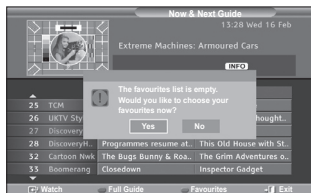
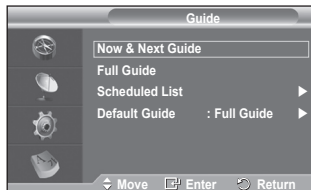

3. Language

This menu consists of 4 sub-menus:

Audio Language, Subtitle Language, Teletext Language, and Preference.



3.1 Audio Language / Subtitle Language / Teletext Language

You can change the default value for subtitle, audio and teletext languages.

- ◆ Press the ▲ or ▼ button to select required menu (**Audio Language, Subtitle Language, or Teletext Language**), then press the **ENTER/OK** button. The options of the selected menu are displayed.

Continued...

3.2 Preference

This menu consists of 6 sub-menus:

Primary Audio Language, Secondary Audio Language, Primary Subtitle Language, Secondary Subtitle Language, Primary Teletext Language, and Secondary Teletext Language.

Using this feature, users can select one of the languages (English, German, Italian, Swedish, French, Welsh, Gaelic, Irish, Danish, Finnish, Norwegian, Spanish, Czech, and Greek). The language selected here is the default when the user selects a channel.

- ◆ Press the ▲ or ▼ button to select required menu (**Primary Audio Language, Secondary Audio Language, Primary Subtitle Language, Secondary Subtitle Language, Primary Teletext Language, or Secondary Teletext Language**), then press the ENTER/OK button. The options of the selected menu are displayed.
- ◆ Press the ▲ or ▼ button to select required option (**English, German, Italian, Swedish, French, Welsh, Gaelic, Irish, Danish, Finnish, Norwegian, Spanish, Czech, or Greek**), then press the ENTER/OK button.
- ◆ If you change the language setting, the **Audio Language, Subtitle Language, and the Teletext Language** of the **Language** menu (refer to page 41) are automatically changed to the selected language.
- ◆ The **Audio Language, Subtitle Language, and the Teletext Language** of the **Language** menu show a list of languages supported by the current channel and the selection is highlighted. If you change this language setting, the new selection is only valid for the current channel. The changed setting does not change the setting of the **Primary Audio Language, Primary Subtitle Language, or the Primary Teletext Language** of the **Preference** menu.

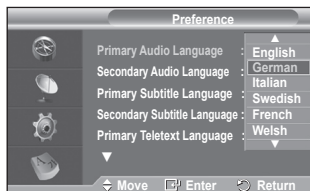
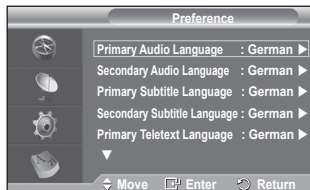

Continued...

4. Setup

This menu consists of 9 sub-menus:

Menu Transparency, Parental Lock, Subtitle, Subtitle Mode, Digital Text, Time Zone, Audio Format, and System.

4.1 Menu Transparency

You can set the translucency of the on-screen menu.

- ◆ Press the ▲ or ▼ button to select required option (**High, Medium, Low, or Opaque**), then press the **ENTER/OK** button.

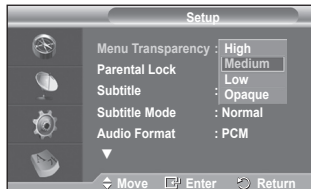
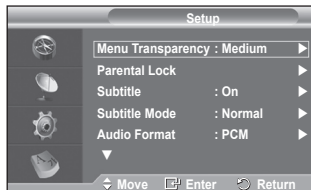

4.2 Parental Lock

This feature allows you to prevent unauthorized users, such as children, from watching unsuitable programmes by a 4-digit PIN (Personal Identification Number) code that is defined by the user.

The on-screen menu will instruct you to assign a PIN code (you can change it later, if necessary).

- ◆ Enter your current 4-digit PIN code by using the numeric buttons (0~9). The **Parental Lock** menu are displayed with the **Parental Rating** selected.
 - ◆ The default PIN code for a new TV set is **0000**.
 - ◆ If you enter an invalid PIN code, the **Invalid PIN code. Please try again.** message is displayed.
- ◆ Press the **ENTER/OK** button. Press the ▲ or ▼ button to select the age rating you want to lock out, then press the **ENTER/OK** button.
- ◆ If you want to change the PIN code, press the ▲ or ▼ button to select **Change PIN**, then press the **ENTER/OK** button.
 - Enter your new PIN code by using the numeric buttons (0~9). The **Confirm New PIN** is displayed.
 - Re-enter your new PIN code to confirm by using the numeric buttons (0~9). The **Your PIN code has been changed successfully** message is displayed.
- If you forget the PIN code, press the remote control buttons in the following sequence, which resets the PIN to **0-0-0-0**: **POWER (Off) → MUTE → 8 → 2 → 4 → POWER (On)**.

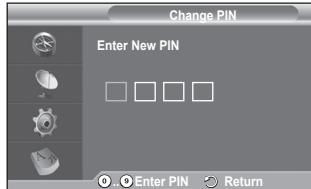
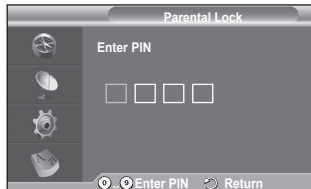
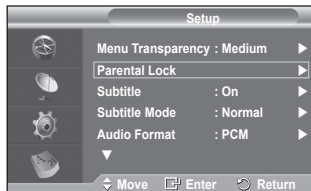

Continued...

4.3 Subtitle / Subtitle Mode / Audio Format / Digital Text

You can use various settings to suit your personal preferences.

- ◆ Press the ▲ or ▼ button to select required menu (**Subtitle**, **Subtitle Mode**, **Digital Text** or **Audio Format**), then press the ENTER/OK button. The options of the selected menu are displayed.

- ◆ Press the ▲ or ▼ button to select required option, then press the ENTER/OK button.

- **Subtitle : On / Off**

- You can select these options simply by pressing the **SUBTITLE** button on the remote control.

- **Subtitle Mode : Normal (basic subtitle) / Hard of hearing (subtitle for a hearing-impaired person)**

- If the programme you are watching does not support the **Hard of hearing** function, **Normal** automatically activates even though **Hard of hearing** mode is selected.

- **Audio Format**

You can only hear Dolby Digital sound through the audio receiver connected through an optical cable. You can only hear PCM sound through the main speaker.

When sound is emitted from both the main speaker and the audio receiver, a sound echo may occur due to the decoding speed difference between the main speaker and the audio receiver. In this case, use the internal mute function.

- Even if you have selected PCM or Dolby Digital in Audio Format, when the input signals are any format of PCM and Dolby Digital, the input format is applied regardless of the setting. If the input signals are not any of those, the setting is not applied.

- **Digital Text : Enable / Disable (UK only)**

- If the programme is broadcast with digital text, this feature is enabled.

- **MHEG** (Multimedia and Hypermedia Information Coding Experts Group)?

An International standard for data encoding systems used in multimedia and hypermedia. This is at a higher level than the MPEG system which includes data-linking hypermedia such as still images, character service, animation, graphic and video files as well as multimedia data. MHEG is user runtime interaction technology and is being applied to various fields including VOD (Video-On-Demand), ITV (Interactive TV), EC (Electronic Commerce), tele-education, tele-conferencing, digital libraries and network games.

4.4 Time Zone (Spain only)

You can select the time zone where you are located.

- This menu is only enabled when you select a country supported by the time zone.

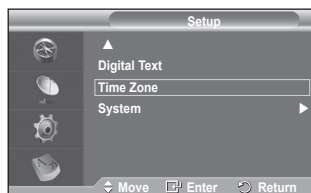
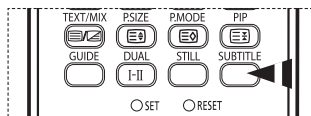
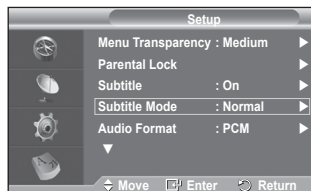
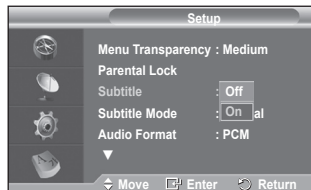
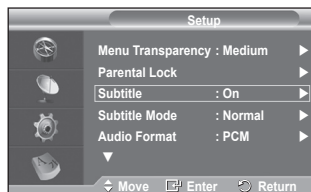

Continued...

4.5 System

This menu consists of 5 sub-menus:

Product Information, Signal Information, Software Upgrade, Common Interface, and Reset.

- Product Information

You can view your product information. For service or repair, please contact a Samsung approved dealer.

- ◆ Press the **ENTER/OK** button with **Product Information** selected. The product information menu is displayed.

- Software Version / Firmware Version

- Signal Information

You can get information about the signal status.

- ◆ Press the **ENTER/OK** button with **Signal Information** selected. The technical information for signal status is displayed.
 - **Service / Service ID / Multiplex / Network / Bit error level / Signal Strength**

- Software Upgrade (Option)

To keep your product up-to-date with new digital television features then software upgrades are periodically broadcast as part of the normal television signal. It will automatically detect these signals and display the software upgrade banner. You are given the option to install the upgrade.

◆ Software Information

Press the **ENTER/OK** button, then the current software version is shown. To display the software version information, press the **ENTER/OK** button again.

◆ Manual Upgrade

Press the **ENTER/OK** button to search for new software from the currently broadcasting channels.

◆ Standby Mode Upgrade : On / Off

Press the **ENTER/OK** button. To continue software upgrade with master power on, Select **On** by pressing the **▲** or **▼** button.

45 minutes after entering standby mode, a manual upgrade is automatically conducted. Since the power of the unit is turned on internally, the screen may be on slightly for the PDP product. This phenomenon may continue for more than 1 hour until the software upgrade is completed.

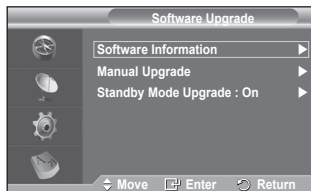
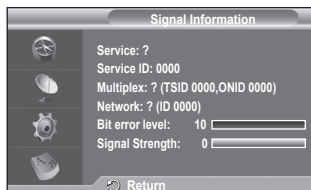
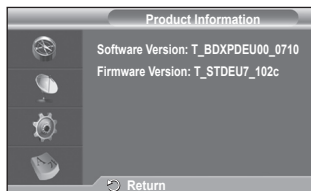
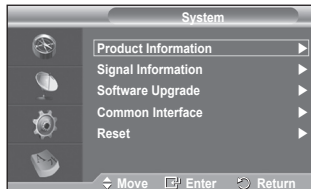
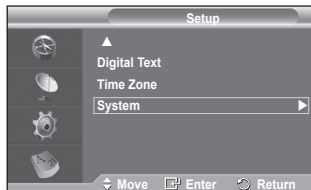

Continued...

- **Common Interface**

◆ **Installing the CI Card**

- a. Purchase the CI CAM module by visiting your nearest dealer or by phone.
- b. Insert the CI CARD into the CAM in the direction of the arrow until it fits.
- c. Insert the CAM with the CI CARD installed into the common interface slot.
 - Insert the CAM in the direction of the arrow, right up to the end so that it is parallel with the slot.
- d. Check if you can see a picture on a scrambled signal channel.
 - You can install the CAM anytime whether the TV is ON or OFF.



◆ **Application Info.**

This contains information on CAM inserted in the CI slot and displays it.

- Press the **ENTER/OK** button to display the information for your application.

◆ **CI Menu**

This helps the user select an item from the CAM-supported menu.

- Press the **ENTER/OK** button. The options of the selected menu are displayed. Press the **▲** or **▼** button to select the required option, then press the **ENTER/OK** button.
 - Select the CI Menu based on the PC Card menu.

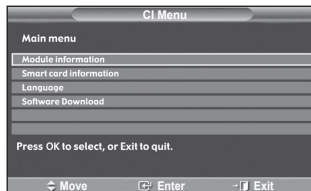

- **Reset**

You can reset the values stored to the factory default values.

- The Reset operation deletes all channel information and user preferences returning all values to their default factory state.

- ◆ Press the **ENTER/OK** button with **Reset** selected. The **Enter PIN** is displayed.

- ◆ Enter your current 4-digit PIN code by using the numeric buttons (0~9). The warning message is displayed. All values will be reset by pressing the coloured buttons (red, green, yellow, and blue) in turn.

- The default PIN of a new TV set is "0-0-0-0".
- When PIN is changed in Child Lock, the PIN for resetting automatically changes.

- ◆ When reset is complete, it operates DTV Plug & Play (DTV Auto Store, Time Zone depending on the country, Time Setting) and exits from the digital TV mode without changing to the analog TV mode. (Refer to page 12)

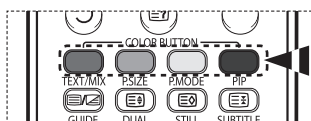
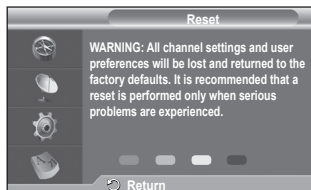

What is Anynet+? (PS42Q96HD/PS42Q97HD/PS50Q96HD/PS50Q97HD)

Anynet+ is an AV network system that enables an easy-to-use AV interface for users by controlling all connected AV devices through the Anynet+ menu when Samsung Electronics AV devices are connected.

Connecting Anynet+ Devices

The Anynet+ system supports AV devices supporting Anynet+ only.
Check if there is an Anynet+ mark on the AV device to be connected to the TV.

To directly connect to TV

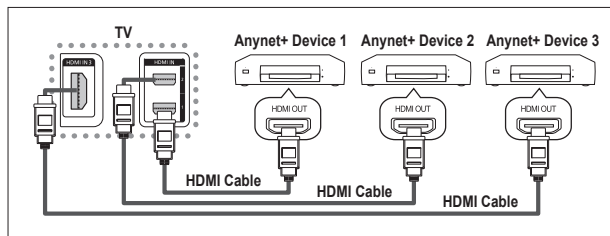

Connect the [HDMI 1], [HDMI 2] or [HDMI 3] jack on the TV and the HDMI OUT jack of the corresponding Anynet+ device using the HDMI cable.

To connect to Home Theater

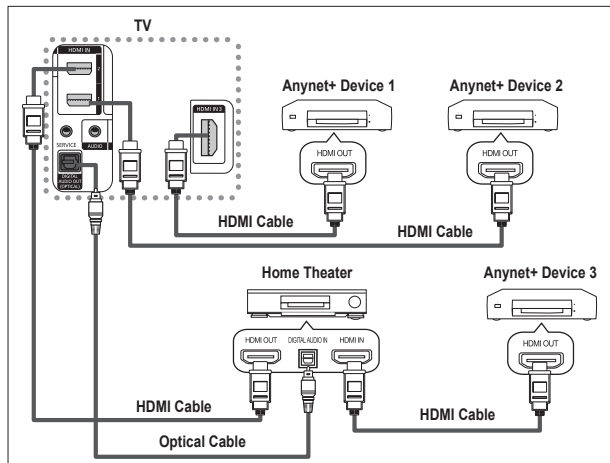

- 1 Connect the [HDMI 1], [HDMI 2] or [HDMI 3] jack on the TV and the HDMI OUT jack of the corresponding Anynet+ device using the HDMI cable.
- 2 Connect the HDMI IN jack of the home theater and the HDMI OUT jack of the corresponding Anynet+ device using the HDMI cable.

- Connect only the optical cable between [Digital Audio Out (Optical)] on your TV and Digital Audio Input on the receiver.
- Connect only one receiver.
- You can listen to 5.1 channel sound through the home theater's speakers. Otherwise, you can only listen to 2 channel stereo sound in other cases. Make sure to connect the Digital Audio IN (Optical) of the home theater and the TV correctly to listen to TV sound through the home theater. However, you cannot listen to sound from the BD recorder that is sent to the home theater via the TV in 5.1 channel sound because the TV outputs only 2 channel stereo sound. Please see the manual for the home theater.
- You can connect an Anynet+ device using the HDMI cable. Some HDMI cables may not support Anynet+ functions.
- Anynet+ works when the AV device supporting Anynet+ is in the Standby or On status.
- Anynet+ supports up to 8 AV devices in total.

Setting Up Anynet+

The following settings are to use Anynet+ functions.

Using the Anynet+ Function

- 1 Press the **Anynet+** button.
Press the **▲** or **▼** button to select **Setup**, then press the **ENTER/OK** button.
- 2 Press the **ENTER/OK** button to select **Anynet+ (HDMI-CEC)**, then press the **ENTER/OK** button.
- 3 Press the **▲** or **▼** button to select **On**, then press the **ENTER/OK** button.
 - The Anynet+ (HDMI-CEC) function is enabled.
 - If you select **Off**, Anynet+ (HDMI-CEC) is disabled.
 - When the Anynet+ (HDMI-CEC) function is disabled, all the Anynet+ related operations are deactivated.

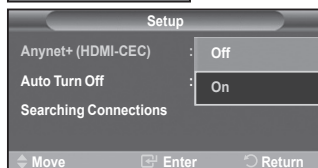

Turning an Anynet+ Device Off Automatically when the TV is Turned Off

- 2 Press the **▲** or **▼** button to select **Auto Turn Off**, then press the **ENTER/OK** button.
- 3 Press the **▲** or **▼** button to select **On**, then press the **ENTER/OK** button.
 - The Auto turn off function is enabled.
 - If you select **Off**, the Auto turn off function is canceled.Press the **EXIT** button to exit.
- The Select Device setting of the TV remote control is to be set to TV to use the Anynet+ function.
- If you set Auto Turn Off to On, connected external devices are also turned off when the TV is turned off. However, if the device is recording, it may not be turned off.

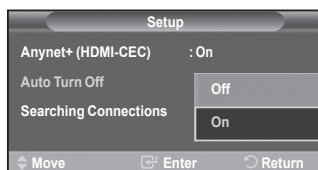

Scanning and Switching between Anynet+ Devices

- 1 Press the **Anynet+** button.
- 2 Press the **▲** or **▼** button to select **Select Device**, then press the **ENTER/OK** button.
- 3 Press the **▲** or **▼** button to select to a particular device and press the **ENTER/OK** button.
It is switched to the selected device.
- 4 If you cannot find a device you want, press the **▲** or **▼** button to select **Searching Connections**, then press the **ENTER/OK** button.
The message **Configuring Anynet+ connection... is** displayed. When searching devices completes, the connected devices are listed in the Anynet+ menu.
 - Switching to the selected devices may take up to 2 minutes. You cannot cancel the operation during the switching operation.
 - The time required to scan for devices is determined by the number of connected devices.
 - When the device scan is complete, the number of found devices is not displayed.
 - Although the TV automatically scans devices when it is turned on using the **POWER** button, devices connected when the TV is on or under a specific circumstance are not displayed in the device list. Therefore select **Searching Connections** menu to search devices.
 - If you have selected external input mode by pressing the **SOURCE** button, you cannot use the Anynet+ function. Make sure to switch to an Anynet+ device by using the **Anynet+** button.

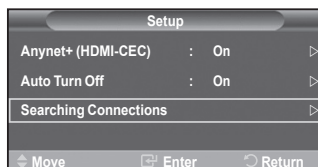

Continued...

Anynet+ Menu

The Anynet+ menu changes depending on the type and status of the Anynet+ devices connected to the TV.

Anynet+ Menu	Description
View TV	Switches from Anynet+ to TV broadcast mode.
Select Device	Your TV connects to the corresponding device.
Record	Starts a recording. (This menu works only for a device supporting recording.)
Menu on Device	Shows the menu of the connected device. Example. When a DVD Recorder is connected, the DVD Recorder's title menu appears.
Device Operation	Shows the play control menu of the connected device. Example. When a DVD Recorder is connected, the play control menu of the DVD Recorder appears.
Receiver	Sound is output through the receiver.
Setup	You can set the environment for using Anynet+.

TV Remote Control Buttons Available in Anynet+ Mode

Device Type	Operating Status	Available Buttons
Anynet+ Device	After switching to the device, when the menu of the corresponding device is displayed on the screen.	Numeric buttons ▲/▼/◀/▶/ENTER buttons Color buttons EXIT button
	After switching to the device, while playing a file	◀◀ (Backward search) ▶▶ (Forward search) ■ (Stop) ▶ (Play/Pause)
Device with built-in Tuner	After switching to the device, when you are watching a TV program	CH ▲/▼ button
Audio Device	When Receiver is activated	VOL +/- button MUTE button
Anyview2	When watching TV	▶ (Play/Pause)

- The Anynet+ function only works when the remote control is set to TV.
- The **REC** button works only while in the recordable state.
- You cannot control Anynet+ devices using the buttons on the side of the TV. You can control Anynet+ devices only using the TV remote control.
- The TV remote control may not work under certain conditions. In this case, re-select the Anynet+ device.
- The Anynet+ functions don't operate for the products from other manufacturers.
- In Anynet+ mode, the color buttons may not work properly.
- The ◀◀, ▶▶ operations may differ depending on the device.

Recording

You can make a recording of a TV program using a recorder.

Press the **REC** button.

Recording begins. (Only when the Anynet+ enabled recording device is connected.)

- The current TV program is recorded in the Watching TV status. If you are watching video from another device, the video from the device is recorded.
- You can also record the source streams by selecting **Record** after pressing the Anynet+ button.
- Before recording, check whether the antenna jack is properly connected to the recording device. For the antenna connection to the recording device, refer to its user manual.

Listening through a Receiver

You can listen to sound through a receiver instead of the TV speaker.

- 1 Press the **Anynet+** button.
Press the **▲** or **▼** button to select **Receiver**, then press the **ENTER/OK** button.
- 2 Press the **◀** or **▶** button to select to **On**, then press the **ENTER/OK** button.
Now you can listen to sound through the receiver.
- 3 Press the **EXIT** button to exit.
 - When the receiver is set to On, you can listen to the TV sound through the 2-channel receiver.
 - If the receiver is exclusively for a home theater only (supporting audio only), it may not appear in the device list.
 - Only when you have connected the optical jack of the TV and the receiver properly, does Receiver work.
 - In case of a content with copyright problem, listening through the receiver may not properly operate.
 - When listening through the receiver, there are restrictions for using the PIP and audio-related menu.



Check Points before Requesting Service

Symptom	Solution
Anynet+ does not work.	<ul style="list-style-type: none"> ■ Check if the device is an Anynet+ device. The Anynet+ system supports Anynet+ devices only. ■ Connect only one receiver. ■ Check if the Anynet+ device power cord is properly connected. ■ Check the Anynet+ device's Video/Audio/HDMI cable connections. ■ Check whether Anynet+ (HDMI-CEC) is set to On in the Anynet+ setup menu. ■ Check whether the TV remote control is in TV mode. ■ Check whether it is Anynet+ exclusive remote control. ■ Anynet+ doesn't work at a certain condition. (Searching channels) ■ When connecting or removing the HDMI cable, please make sure to search devices again or restart your TV. ■ Check if the Anynet+ Function of Anynet+ device is set on.
I want to start Anynet+.	<ul style="list-style-type: none"> ■ Check if the Anynet+ device is properly connected to the TV and check if the Anynet+ (HDMI-CEC) is set to On in the Anynet+ Setup menu. ■ Press the TV button on the TV remote control to switch to TV. Then press the Anynet+ button to show the Anynet+ menu and select a menu you want.
I want to exit Anynet+.	<ul style="list-style-type: none"> ■ Select View TV in Anynet+ menu. ■ Press the SOURCE button on the TV remote control and select a device other than Anynet+ devices. ■ Press any of CH, CH LIST, and PRE-CH to change to the TV mode. (Note that the channel button operates only when a tuner-embedded Anynet+ device is not connected.)
The Connecting to Anynet+ device... message appears on the screen.	<ul style="list-style-type: none"> ■ You cannot use the remote control when you are configuring Anynet+ or switching to a view mode. ■ Use the remote control when the Anynet+ setting or switching to view mode is complete.
The Anynet+ device does not play.	You cannot use the play function when Plug & Play is in progress.
The connected device is not displayed.	<ul style="list-style-type: none"> ■ Check whether or not the device supports Anynet+ functions. ■ Check whether or not the HDMI cable is properly connected. ■ Check whether Anynet+ (HDMI-CEC) is set to On in the Anynet+ setup menu. ■ Search Anynet+ devices again. ■ You can connect an Anynet+ device using the HDMI cable only. Some HDMI cables may not support Anynet+ functions.
The TV program cannot be recorded.	Check whether the antenna jack on the recording device is properly connected.
The TV sound is not output through the receiver.	Connect the optical cable between TV and the receiver.

Teletext Feature (depending on the model)

Most television stations provide written information services via teletext. The index page of the teletext service gives you information on how to use the service. In addition, you can select various options to suit your requirements by using the remote control buttons.

For teletext information to be displayed correctly, channel reception must be stable. Otherwise, information may be missing or some pages may not be displayed.

1 TV/DTV

Exit from the teletext display (depending on the model)

2 [Index]

Used to display the index (contents) page at any time while you are viewing teletext.

3 [Teletext on/mix]

Press to activate teletext mode after selecting the channel providing the teletext service. Press it twice to overlap the teletext with the current broadcasting screen.

4 [Size]

Press to display the double-size letters in the upper half of the screen. For lower half of the screen, press it again. To display normal screen, press it once again.

5 [Mode]

Press to select the teletext mode (LIST/FLOF).

If you press it in the LIST mode, it switches into the List save mode. In the List save mode, you can save teletext page into list using the [Store] button.

6 [Sub-page]

Used to display the available sub-page.

7 [Page up]

Used to display the next teletext page.

8 [Page down]

Used to display the previous teletext page.

9 [Cancel]

Used to display the broadcast when searching for a page.

10 [Reveal]

Used to display the hidden text (answers to quiz games, for example). To display normal screen, press it again.

11 Coloured buttons (red/green/yellow/blue)

If the FASTEXT system is used by a broadcasting company, the different topics covered on a teletext page are colour-coded and can be selected by pressing the coloured buttons. Press one of them corresponding to the required. The page is displayed with other coloured information that can be selected in the same way.

To display the previous or next page, press the corresponding coloured button.

12 [Hold]

Used to hold the display on a given page if the selected page is linked with several secondary pages which follow on automatically. To resume, press it again.

13 [Store]

Used to store the teletext pages.

You can change teletext pages by pressing the numeric buttons on the remote control.

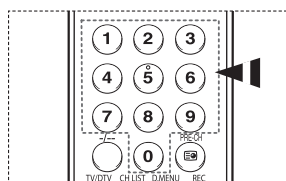
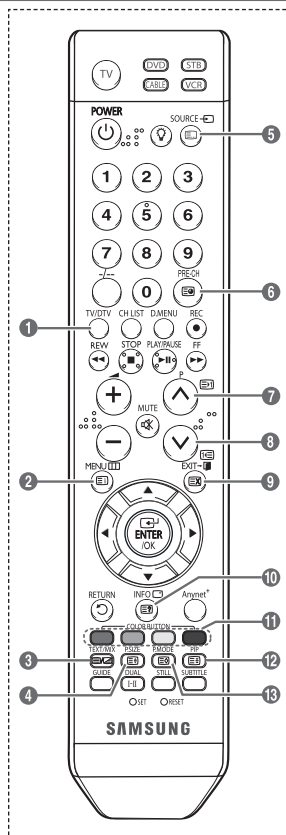

Continued...

The teletext pages are organized according to six categories:

Part	Contents
A	Selected page number.
B	Broadcasting channel identity.
C	Current page number or search indications.
D	Date and time.
E	Text.
F	Status information. FASTEXT information.

- Teletext information is often divided between several pages displayed in sequence, which can be accessed by:
 - ◆ Entering the page number
 - ◆ Selecting a title in a list
 - ◆ Selecting a coloured heading (FASTEXT system)
- Press the **TV/DTV** button to exit from the teletext display.

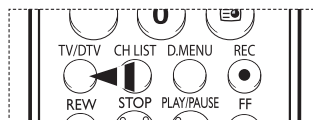
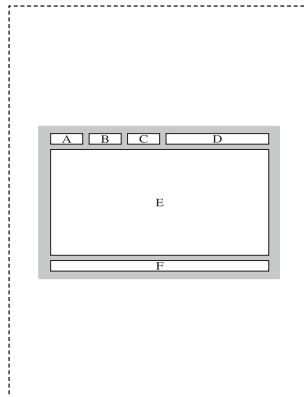

Installing the Wall Mount Kit

This installation is to be used when attaching the wall mount to a wall.
When attaching to other building materials, please contact your nearest dealer.

Wall Mount Kit Specifications (VESA)

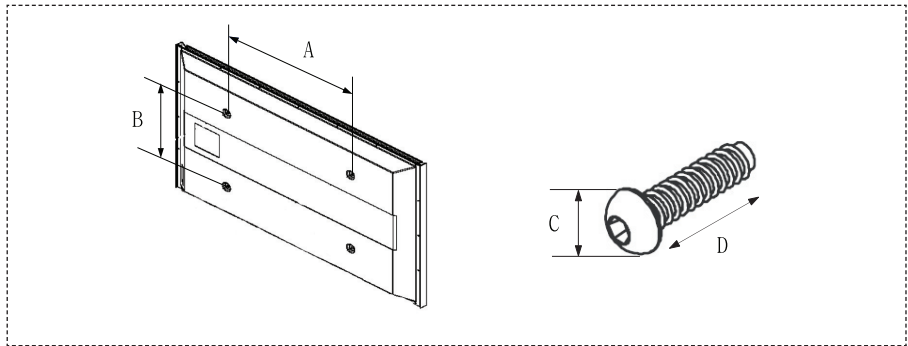

Product Family	inch	VESA Spec. (A * B)	Standard Screw (C * D)	Quantity
LCD-TV	23 ~ 26	200 * 100	M4 * L10	4
	32 ~ 40	200 * 200	M6 * L10	4
	46 ~ 52	600 * 400	M8 * L15	4
	57	700 * 400		
PDP-TV	42 ~ 50	600 * 400	M8	6
	63	No VESA		

- 1 We provide the standard dimensions for wall mount kits as shown in the table above.
- 2 When purchasing our wall mount kit, a detailed installation manual and all parts necessary for assembly are provided.
- 3 Do not use screws longer than the standard dimension, as they may cause damage to the inside of the TV set.
- 4 Our 63" model does not comply with VESA Specifications. Therefore, you should use our dedicated wall mount kit for this model.

Setting Up Your Remote Control

After it has been set up properly, your remote control can operate in five different modes: TV, VCR, Cable, DVD, or Set-Top Box. Pressing the corresponding button on the remote control allows you to switch between these modes, and control whichever piece of equipment you choose.

➤ The remote control might not be compatible with all DVD Players, VCRs, Cable boxes, and Set-Top Boxes.

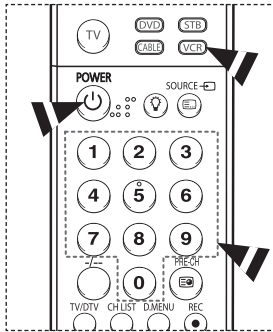

Setting Up the Remote to Operate Your VCR

- 1 Turn off your VCR.
- 2 Press the **VCR** button on your TV's remote control.
- 3 Press the **SET** button on your TV's remote control.
- 4 Using the number buttons on your remote control, enter three digits of the VCR code listed on page 56 of this manual for your brand of VCR. Make sure you enter three digits of the code, even if the first digit is a "0". (If more than one code is listed, try the first one.)
- 5 Press the **POWER** button on the remote control. Your VCR should turn on if your remote is set up correctly.

If your VCR does not turn on after set-up, repeat steps 2, 3 and 4, but try one of the other codes listed for your brand of VCR. If no other codes are listed, try each VCR code, 000 through 080.

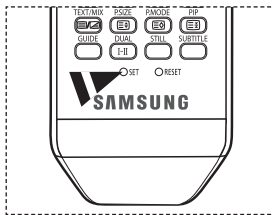

Note on Using Remote Control Modes: VCR

When your remote control is in **VCR** mode, the volume buttons still control your TV's volume.

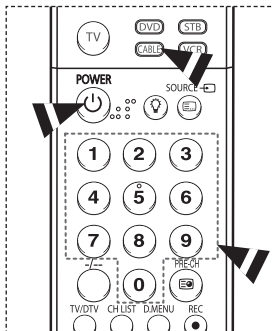

Setting Up the Remote to Operate Your Cable Box

- 1 Turn off your cable box.
- 2 Press the **CABLE** button on your TV's remote control.
- 3 Press the **SET** button on your TV's remote control.
- 4 Using the number buttons on your remote control, enter three digits of the cable box code listed on page 57 of this manual for your brand of cable box. Make sure you enter three digits of the code, even if the first digit is a "0". (If more than one code is listed, try the first one.)
- 5 Press the **POWER** button on the remote control. Your cable box should turn on if your remote is set up correctly.

If your cable box does not turn on after set-up, repeat steps 2, 3 and 4, but try one of the other codes listed for your brand of cable box. If no other codes are listed, try each code, 000 through 046.

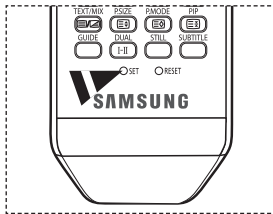

Note on Using Remote Control Modes: Cable Box

When your remote control is in **CABLE** mode, the volume buttons still control your TV's volume.

Continued...

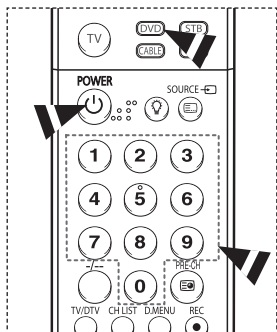

Setting Up the Remote to Operate Your DVD

- 1 Turn off your DVD.
- 2 Press the **DVD** button on your TV's remote control.
- 3 Press the **SET** button on your TV's remote control.
- 4 Using the number buttons on your remote control, enter three digits of the DVD code listed on page 58 of this manual for your brand of DVD. Make sure you enter three digits of the code, even if the first digit is a "0". (If more than one code is listed, try the first one.)
- 5 Press the **POWER** button on the remote control.

Your DVD should turn on if your remote is set up correctly.
 If your DVD does not turn on after set-up, repeat steps 2, 3 and 4, but try one of the other codes listed for your brand of DVD. If no other codes are listed, try each code, 000 through 141.

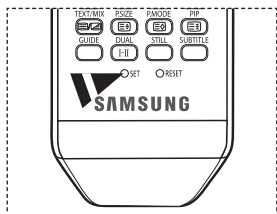

Note on Using Remote Control Modes: DVD

When your remote control is in **DVD** mode, the volume buttons still control your TV's volume.

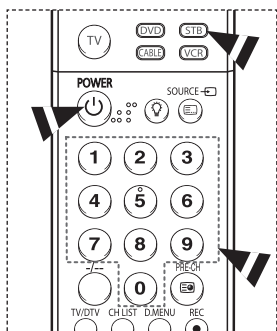

Setting Up the Remote to Operate Your Set Top Box

- 1 Turn off your STB.
- 2 Press the **STB** button on your TV's remote control.
- 3 Press the **SET** button on your TV's remote control.
- 4 Using the number buttons on your remote control, enter three digits of the STB code listed on page 57 of this manual for your brand of STB. Make sure you enter three digits of the code, even if the first digit is a "0". (If more than one code is listed, try the first one.)
- 5 Press the **POWER** button on the remote control.

Your STB should turn on if your remote is set up correctly.
 If your STB does not turn on after set-up, repeat steps 2, 3 and 4, but try one of the other codes listed for your brand of STB. If no other codes are listed, try each code, 000 through 074.

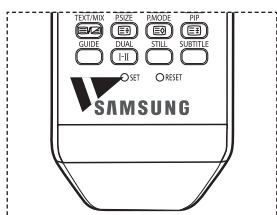

Note on Using Remote Control Modes: STB

When your remote control is in **STB** mode, the volume buttons still control your TV's volume.

Continued...

Remote Control Codes

VCR

Brand	Code
SAMSUNG	000 001 002 003 004 005 077 078 079
ADMIRAL	020
AIWA	025
AKAI	004 027 032
AUDIO DYNAMICS	007 026
BELL&HOWELL	018
BROKSONIC	022
CANDLE	002 003 006 008 015 055
CANON	021 056
CITIZEN	002 003 006 008 015 055
COLORTYME	007
CRAIG	002 024
CURTIS MATHES	002 007 008 017 021 025 056 064 066
DAEWOO	003 010 011 012 013 014 015 016
DB	007 026
DIMENSIA	017
DYNATECH	025
ELECTROHOME	034
EMERSON	001 003 006 021 022 025 030 032 034 040 047 050 052 060 063 065 066 067 069 073
FISHER	018 024 028 029 048 051 061
FUNAI	025
GENERAL ELECTRIC	002 005 017 021 056
GO VIDEO	002
LG(Goldstar)	006 007 008 009 010
HARMAN KARDON	007
HITACHI	019 025 041 042 074
INSTANT REPLAY	021
JC PENNEY	002 007 018 019 021 026 037 041 054 056
JCL	007 008 018 021 026 037
KENWOOD	007 008 018 026 037
KLH	070
LLOYD	025
LOGIK	038
LXI	025
JVC	081 082 083
MAGNAVOX	021 056 059
MARANTZ	007 008 018 021 026 037 062
MARTA	006
KONIA	036
ORION	073 074 075 076
MEI	021
MEMOREX	006 021 024 025
MGA	034
MIDLAND	005
MINOLTA	019 041 075

Brand	Code
MITSUBISHI	019 034 041 046
MONTGOMERY WARD	020
MTC	002 025
MULTITECH	002 005 025 038
NEC	007 008 018 026 037 062 064
OPTIMUS	020
PANASONIC	021 056 071 072
PENTAX	019 041 075
PENTEX RESEARCH+	008
PHILCO	021 056 059
PHILIPS	021 080
PIONEER	019 026 039 053
PORTLAND	015 049 055
PROSCAN	017
QUARTZ	018
QUASAR	021 056
RADIO SHACK/	006 018 020 021 024 025 029 034
REALISTIC	048 056
RCA	002 017 019 021 035 041 043 057 068 076
SANSUI	026
SANYO	018 024
SCOTT	003 047 052 067
SEARS	006 018 019 024 028 029 041 048 051
SHARP	020 034 045 015
SHIMTOM	027 033 038 058
SIGNATURE	025
SONY	027 033 044
SYLVANIA	021 025 056 059
SYMPHONIC	025
TANDY	018 025
TASHIKA	006
TATUNG	037
TEAC	025 037 068
TECHNICS	021
TEKNIKA	006 021 025 031
TMK	066
TOSHIBA	003 019 029 051 052
TOTEVISION	002 006
UNITECH	002
VECTOR RESEARCH	007 026
VICTOR	026
VIDEO CONCEPTS	007 026
VIDEOSONIC	002
WARDS	002 003 006 019 020 021 024 025 034 038 041
YAMAHA	007 008 018 026 037
ZENITH	023 027 033

Continued...

CABLE BOX

Brand	Code
SAMSUNG	000 001 002 003 004 005 006 007
GI	041
HAMLIN	003 024 031
HITACHI	025 030
JERROLD	038 039
MACOM	025 030
MAGNAVOX	019 023 028
OAK	026
PANASONIC	003 022 027 037 044
PHILIPS	019 021 023 028
PIONEER	004 018 020 044
RCA	014 022 040
REGAL	003

Brand	Code
REGENCY	015 023
SA	042 043
SCIENTIFIC ATLAN	042 043
SPRUCER	022
STARGATE 2000	036
SYLVANIA	016
TEXSCAN	016
TOCOM	032
UNIVERSAL	033 034
VIEWSTAR	019 021 023 028
WARNER AMEX	046
ZENITH	017 029 035 037 045

SAMSUNG SET-TOP BOX

Product	Code
Ground wave STB	001 002
Satellite STB	003
CABLE STB	004
STB DVD COMBO	008
Satellite STB HDD COMBO Standard	009

Product	Code
Satellite STB HDD COMBO Premium	010
CABLE STB HDD COMBO Standard	011
CABLE STB HDD COMBO Premium	012
Ground wave STB HDD COMBO Standard	013
Ground wave STB HDD COMBO Premium	014

SET-TOP BOX

Brand	Code
ALPHASTAR	023
ANAM	043
CHANNEL MASTER	018 034
CROSSDIGITAL	019
CHAPARRAL	035
DIRECT TV	015 016 017 019 022 045 060 061 062 065 066 067 068
DAEWOO	074
DISH NETWORK SYSTEM	069 070
DISHPRO	069
DRAKE	018 024 032
DX ANTENNA	027
ECHOSTAR	025 069 070 071
EXPRESSVU	069
GOI	069
GE	065
GENERAL INSTRUMENT	046 047 048 063 064
HTS	069
HOME CABLE	056
HITACHI	022
HUGHES NETWORK	015 017
IQ	020
IQ PRISM	020
JANEIL	059
JERROLD	063
JVC	069 070

Brand	Code
LG(Goldstar)	044 073
MAGNAVOX	016 021 036 038 039 040 041 042
MEMOREX	016
MOTOROLA	064
MACOM	018
MITSUBISHI	015
NEXT LEVEL	047 048 064
PHILIPS	015 016 017 021 033 036 038 039 040 041 042 067
PRIMESTAR	046 049 050 063
PANASONIC	058 059 061 062
PAYSAT	016
PROSCAN	065 066
RCA	051 052 053 065 066
RADIOSHACK	064
REALISTIC	057
STS	020 027
STAR TRAK	026
SKY	031
SKY LIFE	005 006 007
SHACK	064
STAR CHOICE	064
SONY	054 060
TOSHIBA	015 017 028 029 030 072
ULTIMATE TV	060 066
UNIDEN	016 021 037 055 056 057
ZENITH	024 031 068

Continued...

SAMSUNG DVD

Product	Code
DVD	000 001 002
DVDR	003 004
BD Record	005 006
VCR COMBO	007 008 009 010 011
VCR Record	012
DHR COMBO	013

Product	Code
Home Theater VCR COMBO	014 015 016
HDD Record COMBO	017
TWIN TRAY COMBO	018
STB DVD COMBO	019
DVD Receiver	020
AV Receiver	021

DVD

Brand	Code
ANAM	030
AUDIOVOX	075
AUDIOLOGIC	085
ANABA	072
APEX DIGITAL	070 071 074 086 083 084 088 111 112
AIWA	114
BROKSONIC	062
BLAUPUNKT	074
B&K	122 123
CURTIS MATHES	027
CYBER HOME	065 077 078 079 082
CLARION	080 125
CIRRUS	081
CINEVISION	095
DAEWOO	066
DENON	146
FARENHEIT	067 068
FISHER	090
GPX	060
GO VIDEO	061 089 133 135
GE	069 074
GREENHILL	074
HITACHI	064 113
HITEKER	071
HOYO	073
HARMAN / KARDON	091 110
IRT	089
INTEGRA	092
JBL	091
JVC	022 033 115 116
JATON	073
KENWOOD	051 108 109
KISS	073
KONKA	059 100 106 107
KLH	074 075
LG(Goldstar)	025 031
LOEWE	057
LASONIC	058
MOBILE AUTHORITY	054
MEMOREX	055
MALATA	056
MAGNAVOX	076 093
MINTEK	074 094
MONYKA	073

Brand	Code
NORCENT	048 049 050
NEXT BASE	052
NEC	053
NANTAU	144
NESA	074
OPTOMEDIA ELECTRONICS	105
OPTIVIEW	072
ONKYO	076 092 119
PHILCO	044 045
PRINCETON	046 047
PROSCAN	023
PANASONIC	024 034 124 134 136 137 138
PHILIPS	036 076
ROTEL	117 118
RIO	120
RCA	023 035 074 075 131 132
RAITE	073
ROWA	038
SAMPO	104
SONY	026 029 126 127 128 129 130 141
SHERWOOD	039 041
SVA	042
SYLVANIA	043 093
SHARP	140
SANSUI	062
SANYO	062
SHINSONIC	094
SANYO	090
THOMSON	145
TOSHIBA	028 062 076
TECHNICS	139
TVIEW	072
TOKAI	073
TEAC	096
TECHWOOD	097
TREDEX	098 099 101
URBAN CONCEPTS	076
VENTURER	075
VOCOPRO	102
YAMAHA	032 063
YAMAKAWA	040 073
XWAVE	103
ZENITH	076 121

How to assemble the Stand-Base (depending on the model)

Using the 6 screws for securing the stand base and the monitor, firmly attach the monitor to the stand base.
(The exterior of the set may be different than the picture.)

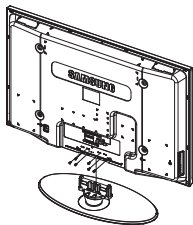

Warning

Firmly secure the stand to the TV before moving it, as the stand may fall and could cause serious injury.

- Two or more people should carry the TV. Never lay the TV on the floor because of possible damage to the screen.
Always store the TV upright.

In case of installing your TV on the wall, close the cover (1) on the stand-base connection part using two screws for hiding.

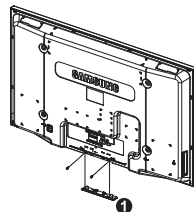

Troubleshooting

Before contacting the Samsung after-sales service, perform the following simple checks.
If you cannot solve the problem using the instructions below, note the model and serial number of the television and contact your local dealer.

No sound or picture

- ◆ Check that the mains lead has been connected to a wall socket.
- ◆ Check that you have pressed the  (Power) button (On/Off) on the front panel or press the **POWER** button on the remote control.
- ◆ Check the picture contrast and brightness settings.
- ◆ Check the volume.
- ◆ Check if Internal Mute is set to ON.

Normal picture but no sound

- ◆ Check the volume.
- ◆ Check whether the volume **MUTE** button on the remote control has been pressed.

No picture or black and white picture

- ◆ Adjust the colour settings.
- ◆ Check that the broadcast system selected is correct.

Sound and picture interference

- ◆ Try to identify the electrical appliance that is affecting the television, then move it further away.
- ◆ Plug the television into a different main socket.

Blurred or snowy picture, distorted sound

- ◆ Check the direction, location and connections of your aerial.
This interference often occurs due to the use of an indoor aerial.

Remote control malfunctions

- ◆ Replace the remote control batteries.
- ◆ Clean the upper edge of the remote control (transmission window).
- ◆ Check that the "+" and "-" ends of the batteries are inserted correctly.
- ◆ Check that the batteries are drained.

Screen is black and power indicator light blinks steadily

- ◆ On your computer check; Power, Signal Cable.
- ◆ The TV is using its power management system.
- ◆ Move the computer's mouse or press any key on the keyboard.
- ◆ On your equipment check (STB, DVD, etc) ; Power, Signal Cable.
- ◆ The TV is using its power management system.
- ◆ Press the Source button on the panel or remote control.
- ◆ Turn the TV off and on.

Specifications

The descriptions and characteristics in this booklet are given for information purposes only and are subject to modification without notice.

Model Name	PS42Q96HD/PS42Q97HD PS42C9HD/PS42C96HD	PS50Q96HD/PS50Q97HD PS50C9HD/PS50C96HD
Screen Size (Diagonal)	42 inch	50 inch
PC Resolution	1024 x 768 @ 60 Hz	1360 x 768 @ 60 Hz
Sound (Output)	10 W + 10 W 10 W + 10 W	15 W + 15 W 10 W + 10 W
Dimension (WxHxD)		
Body	1055 x 700 x 104 mm 1055 x 700 x 95 mm	1231 x 789 x 104 mm 1231 x 789 x 95 mm
With stand	1055 x 757 x 316 mm 1055 x 759 x 316 mm	1231 x 849 x 316 mm 1231 x 849 x 316 mm
Weight		
Body	31 kg 31 kg	42 kg 41 kg
With stand	34 kg 34 kg	44 kg 44 kg
Environmental Considerations		
Operating Temperature	10 °C to 40 °C (50 °F to 104 °F)	
Operating Humidity	10% to 80%, non-condensing	
Storage Temperature	-20 °C to 45 °C (-4 °F to 113 °F)	
Storage Humidity	5% to 95%, non-condensing	

- ◆ This device is a Class B digital apparatus.
- ◆ Design and specifications are subject to change without prior notice.
- ◆ For the power supply, refer to the label attached to the product.

***This page is intentionally
left blank.***

***This page is intentionally
left blank.***

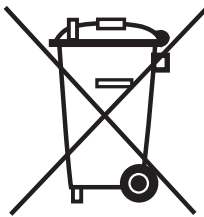

Correct Disposal of This Product (Waste Electrical & Electronic Equipment)

(Applicable in the European Union and other European countries with separate collection systems)

This marking shown on the product or its literature, indicates that it should not be disposed with other household wastes at the end of its working life.

To prevent possible harm to the environment or human health from uncontrolled waste disposal, please separate this from other types of wastes and recycle it responsibly to promote the sustainable reuse of material resources.

Household users should contact either the retailer where they purchased this product, or their local government office, for details of where and how they can take this item for environmentally safe recycling.

Business users should contact their supplier and check the terms and conditions of the purchase contract. This product should not be mixed with other commercial wastes for disposal.



Contact SAMSUNG WORLD-WIDE

If you have any questions or comments relating to Samsung products, please contact the SAMSUNG customer care centre.

Country	Customer Care Centre ☎	Web Site
BELGIUM	02 201 2418	www.samsung.com/be
CZECH REPUBLIC	844 000 844	www.samsung.com/cz
DENMARK	70 70 19 70	www.samsung.com/dk
ESTONIA	800-7267	www.samsung.ee
FINLAND	030-6227 515	www.samsung.com/fi
FRANCE	3260 SAMSUNG (7267864) (€ 0,15/min)	www.samsung.com/fr
GERMANY	01805-121213 (€ 0,14/Min)	www.samsung.de
HUNGARY	06-80-SAMSUNG (7267864)	www.samsung.com/hu
ITALIA	800 SAMSUNG (7267864)	www.samsung.com/it
KAZAKHSTAN	8 800 080 11 88	www.samsung.kz
LATVIA	800-7267	www.samsung.com/lv
LITHUANIA	8-800-77777	www.samsung.lt
LUXEMBURG	0032 (0)2 201 24 18	www.samsung.lu
NETHERLANDS	0900 20 200 88 (€ 0,10/Min)	www.samsung.com/nl
NORWAY	815-56 480	www.samsung.com/no
POLAND	0 801 801 881	www.samsung.com/pl
PORTUGAL	80 8 200 128	www.samsung.com/pt
REPUBLIC OF IRELAND	0818 717 100	www.samsung.com/uk
RUSSIA	8-800-200-0400	www.samsung.ru
SLOVAKIA	0800-SAMSUNG (7267864)	www.samsung.com/sk
SPAIN	902 10 11 30	www.samsung.com/es
SWEDEN	0771-400 200	www.samsung.com/se
SWITZERLAND	0800-7267864	www.samsung.com/ch
U.K	0870 SAMSUNG (7267864)	www.samsung.com/uk
UKRAINE	8-800-502-0000	www.samsung.com/ur
UZBEKISTAN	140-1234	www.samsung.uz