



**SAMSUNG**

**HP-T4264  
HP-T5064**

**PLASMA DISPLAY**



# **Owner's Instructions**

Register your product at [www.samsung.com/global/register](http://www.samsung.com/global/register)  
Record your Model and Serial number here for future reference.

▪ Model \_\_\_\_\_ ▪ Serial No. \_\_\_\_\_

## Important Warranty Information Regarding Television Format Viewing

Wide screen format PDP Displays (16:9, the aspect ratio of the screen width to height) are primarily designed to view wide screen format full-motion video. The images displayed on them should primarily be in the wide screen 16:9 ratio format, or expanded to fill the screen if your model offers this feature and the images are constantly moving. Displaying stationary graphics and images on screen, such as the dark side-bars on nonexpanded standard format television video and programming, should be limited to no more than 5% of the total television viewing per week.

Additionally, viewing other stationary images and text such as stock market reports, video game displays, station logos, web sites or computer graphics and patterns, should be limited as described above for all televisions. **Displaying stationary images that exceed the above guidelines can cause uneven aging of PDP Displays that leave subtle, but permanent burned-in ghost images in the PDP picture. To avoid this, vary the programming and images, and primarily display full screen moving images, not stationary patterns or dark bars.**

On PDP models that offer picture sizing features, use these controls to view different formats as a full screen picture.

Be careful in the selection and duration of television formats used for viewing. Uneven PDP aging as a result of format selection and use, as well as burned-in images, are not covered by your Samsung limited warranty.

### U.S.A Only

The product unit accompanying this user manual is licensed under certain intellectual property rights of certain third parties. In particular, this product is licensed under the following US patents: 5,991,715, 5,740,317, 4,972,484, 5,214,678, 5,323,396, 5,539,829, 5,606,618, 5,530,655, 5,777,992, 6,289,308, 5,610,985, 5,481,643, 5,544,247, 5,960,037, 6,023,490, 5,878,080, and under US Published Patent Application No. 2001-44713-A1.

This license is limited to private non-commercial use by end-user consumers for licensed contents. No rights are granted for commercial use. The license does not cover any product unit other than this product unit and the license does not extend to any unlicensed product unit or process conforming to ISO/IEC 11172-3 or ISO/IEC 13818-3 used or sold in combination with this product unit. The license only covers the use of this product unit to encode and/or decode audio files conforming to the ISO/IEC 11172-3 or ISO/IEC 13818-3. No rights are granted under this license for product features or functions that do not conform to the ISO/IEC 11172-3 or ISO/IEC 13818-3.

### Other countries

The product unit accompanying this user manual is licensed under certain intellectual property rights of certain third parties. This license is limited to private non-commercial use by end-user consumers for licensed contents. No rights are granted for commercial use. The license does not cover any product unit other than this product unit and the license does not extend to any unlicensed product unit or process conforming to ISO/IEC 11172-3 or ISO/IEC 13818-3 used or sold in combination with this product unit. The license only covers the use of this product unit to encode and/or decode audio files conforming to the ISO/IEC 11172-3 or ISO/IEC 13818-3. No rights are granted under this license for product features or functions that do not conform to the ISO/IEC 11172-3 or ISO/IEC 13818-3.

# User Instructions

## ● Screen Image retention

Do not display a still image (such as on a video game) on the plasma display panel for more than several minutes as it can cause screen image retention. This image retention is also known as “screen burn”. To avoid such image retention, refer to page 26 of this manual to reduce the degree of brightness and contrast of the screen when displaying a still image.

## ● Altitude

The PDP can only operate normally at heights under 6500ft.

## ● Heat on the top of the PDP TV

The top side of the product may be hot after long periods of use as heat dissipates from the panel through the vent hole in the upper part of the product.

This is normal and does not indicate any defect or operation failure of the product.

However, children should be prevented from touching the upper part of the product.

## ● The product is making a ‘cracking’ noise.

A ‘cracking’ noise may occur when the product contracts or expands due to a change of surrounding environment such as temperature or humidity. This is normal and not a defect of the unit.

## ● Cell Defects

The PDP uses a panel consisting of 1,230,000(SD-level) to 3,150,000(HD-level) pixels which require sophisticated technology to produce. However, there may be a few bright or dark pixels on the screen. These pixels will have no impact on the performance of the product.

## ● Avoid operating the TV at temperatures below 5°C (41°F)

## ● A still image displayed too long may cause permanent damage to the PDP Panel.

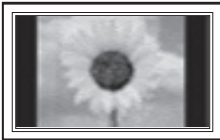

Watching the PDP TV in 4:3 format for a long period of time may leave traces of borders displayed on the left, right and center of the screen caused by the difference of light emission on the screen.

Playing a DVD or a game console may cause similar effect to the screen.

Damages caused by the above effect are not covered by the Warranty.

## ● Afterimage on the Screen.

Displaying still images from Video games and PC for longer than a certain period of time may produce partial after-images. To prevent this effect, reduce the ‘brightness’ and ‘contrast’ when displaying still images for a long time.

## ● Warranty

Warranty does not cover any damage caused by image retention.

Burn-in is not covered by the warranty.

# Contents

## GENERAL INFORMATION

■ List of Features .....	5
■ Accessories .....	5
■ Viewing the Control Panel .....	6
■ Viewing the Connection Panel .....	7
■ Remote Control .....	8
■ Installing Batteries in the Remote Control .....	9

## CONNECTIONS

■ Connecting VHF and UHF Antennas .....	9
■ Connecting Cable TV .....	10
■ Connecting a VCR .....	11
■ Connecting an S-VHS VCR .....	11
■ Connecting a Camcorder .....	12
■ Connecting a DVD Player/Set-Top Box .....	12
■ Connecting a DVD Player/Set-Top Box via HDMI .....	13
■ Connecting a DVD Player/Set-Top Box via DVI .....	13
■ Connecting a Digital Audio System .....	14
■ Connecting an Amplifier/DVD Home Theater .....	14
■ Connecting a PC .....	14

## OPERATION

■ Turning the TV On and Off .....	15
■ Plug & Play Feature .....	15
■ Changing Channels .....	17
■ Adjusting the Volume .....	18
■ Viewing the Display .....	18
■ Viewing the Menus .....	18
■ Memorizing the Channels .....	19
■ Setting Up Your Remote Control .....	20
■ To Select the Source .....	25
■ To Edit the Input Source Name .....	25

## PICTURE CONTROL

■ Using Automatic Picture Settings .....	26
■ Digital Noise Reduction .....	27
■ Changing the Screen Size .....	28
■ Configuring Detailed Settings on the Picture .....	29
■ Active Color .....	30
■ DNIe (Digital Natural Image engine) .....	30
■ Selecting the Film Mode .....	31
■ Setting the Blue Screen Mode .....	31
■ Setting the HDMI Black Level .....	31
■ Viewing Picture-in-Picture .....	32
■ Freezing the Current Picture .....	33

## SOUND CONTROL

■ Using Automatic Sound Settings .....	34
■ Customizing the Sound .....	34
■ Setting the TruSurround XT .....	35
■ Choosing a Multi-Channel Sound (MTS) Track - Digital ..	35
■ Choosing a Multi-Channel Sound (MTS) Track - Analog ..	36
■ Automatic Volume Control .....	36
■ Selecting the Internal Mute .....	36
■ Adjusting the Melody Sound .....	37
■ Listening to the Sound of the Sub (PIP) Picture .....	37

## CHANNEL CONTROL

■ Selecting the Antenna .....	38
■ Adding and Erasing Channels .....	38
■ Setting Your Favorite Channels .....	39
■ Viewing the Channel Lists .....	40
■ Setting the Default Channel List Mode .....	40
■ Labeling Channels .....	41
■ Fine Tuning Analog Channels .....	41
■ Checking the Digital-Signal Strength .....	42
■ LNA (Low Noise Amplifier) .....	42

## PC DISPLAY

■ Using Your TV as a Computer (PC) Display .....	43
■ Display Modes .....	43
■ Setting up the TV with your PC .....	44
■ Setting the Home Theater PC .....	45

## TIME SETTING

■ Setting the Time .....	46
--------------------------	----

## FUNCTION DESCRIPTION

■ Selecting a Menu Language .....	49
■ Using the Game Mode .....	49
■ Viewing Closed Captions (On-Screen Text Messages) - Digital ..	50
■ Viewing Closed Captions (On-Screen Text Messages) - Analog ..	51
■ Menu Transparency Level .....	52
■ Setting the Light Effect .....	52
■ Using the Energy Saving Feature .....	53
■ Preventing Screen Burn-in .....	53
■ Reducing the Effects of Screen Burn .....	54
■ Setting the Function Help .....	54
■ Wall-mount adjustment (Sold separately) .....	55
■ Upgrading the Software .....	56
■ Using the V-Chip .....	56

## WISELINK

■ Using the WISELINK Function .....	62
■ Using the WISELINK Mode .....	63
■ Using the Photo (JPEG) List .....	64
■ Using the Music (MP3) List .....	70
■ Using the Setup Menu .....	71

## About Anynet+

■ What is Anynet+? .....	72
■ Connecting Anynet+ Devices .....	72
■ Setting Up Anynet+ .....	73
■ Scanning and Switching between Anynet+ Devices .....	73
■ Recording .....	74
■ Listening through a Receiver .....	75
■ Check Points before Requesting Service .....	75

## APPENDIX

■ Troubleshooting .....	76
■ Installing the Wall Mount Kit .....	77
■ How to assemble the Stand-Base (depending on the model) .....	78
■ Specifications .....	78
■ Dimensions (HP-T4264) .....	79
■ Dimensions (HP-T5064) .....	80

## Symbols



Press



One-Touch  
Button



Note

# General Information

## List of Features

- Adjustable picture settings that can be stored in the TV's memory.
- Automatic timer to turn the TV on and off.
- A special sleep timer.
- V-Chip function.
- Excellent Digital Interface & Networking :  
With a built-in HD digital tuner, non-subscription HD broadcasts can be viewed with no Set-Top Box needed.
- Remote Control  
The supplied remote can be used to operate the TV as well as most DVD players, Set-top boxes, Cable Boxes and VCRs.
- Excellent Picture Quality  
- DNIe technology provides life-like clear images.
- SRS TruSurround XT  
- SRS TruSurround XT provides a virtual Dolby surround system.

## Accessories

Please make sure the following items are included with your TV. If any items are missing, contact your dealer.

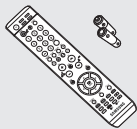

Remote Control  
(BN59-00599A) /  
AAA Batteries  
(4301-000103)



Power Cord  
(3903-000144)



Owner's Instructions /  
Quick Setup Guide



Warranty Card /  
Registration Card /  
Safety Guide Manual



Cloth-Clean

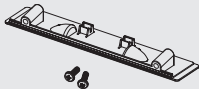

Cover-Bottom /  
Screws (2ea)  
(Refer to page 78)



Ferrite Core for  
Power Cord  
(3301-001110)



Ferrite Core for  
Side-AV / S-VIDEO  
(3301-001305)



Ferrite Core for  
Headphone  
(3301-001456)

The following parts are sold separately and are available at most electronics stores.



S-VIDEO Cable (BN39-00149A)



HDMI Cable (BN39-00641A)

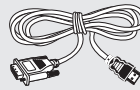

HDMI/DVI cable (BN39-00643A)

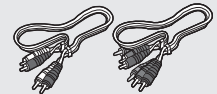

Component Cables (RCA)  
(BN39-00279A)



PC Cable (BN39-00115A)



PC Audio Cable (BN39-00061B)



Optical Cable



Antenna Cable (BN39-00333A)

### ➤ Ferrite Core (Power Cord, Audio/Video Cable, S-Video Cable, Headphone)

The ferrite cores are used to shield the cables from interference. When connecting a cable, open the ferrite core and clip it around the cable near the plug.

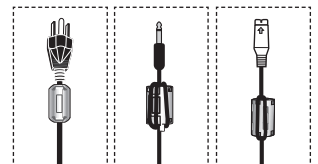

## Viewing the Control Panel

### Buttons on the Lower-Right Part of the Panel

The buttons on the lower-right panel control your TV's basic features, including the on-screen menu. To use the more advanced features, you must use the remote control.

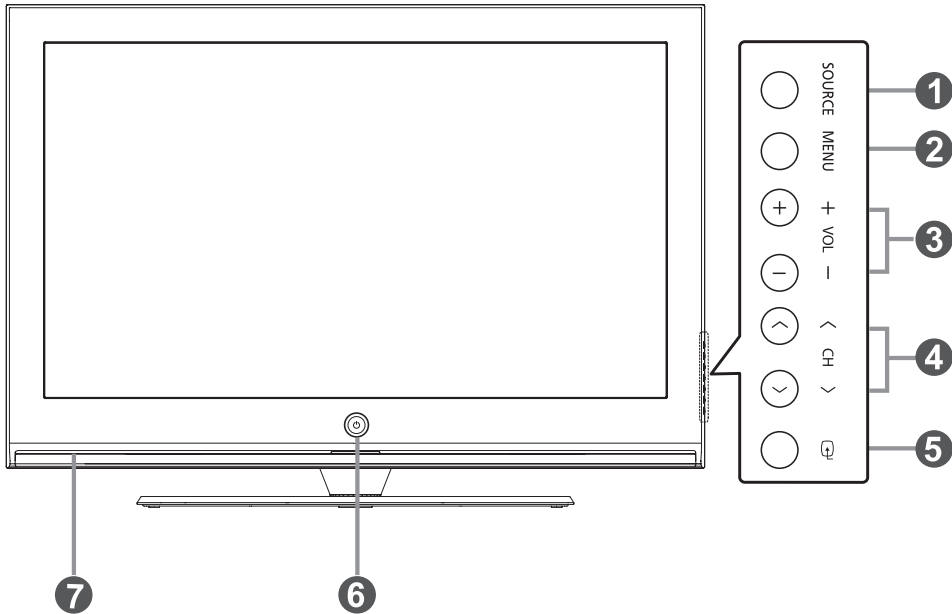

➤ The product color and shape may vary depending on the model.

#### 1 SOURCE

Toggles between all the available input sources (TV, AV1, AV2, S-Video1, S-Video2, Component1, Component2, PC, HDMI1, HDMI2, or HDMI3).

#### 2 MENU

Press to see an on-screen menu of your TV's features.

#### 3 + VOL -

Press to increase or decrease the volume. In the on-screen menu, use the + VOL - buttons as you would use the ◀ and ▶ buttons on the remote control.

#### 4 ^ CH v

Press to change channels. In the on-screen menu, use the ^ CH v buttons as you would use the ▲ and ▼ buttons on the remote control.

#### 5 (ENTER)

Press to confirm a selection.

#### 6 POWER

Press to turn the TV on and off.

#### Power Indicator

Blinks and turns off when the power is on and lights up in stand-by mode.

#### Remote Control Sensor

Aim the remote control towards this spot on the TV.

#### 7 Speakers

## Viewing the Connection Panel

### Rear Panel Jacks

Use the rear panel jacks to connect A/V components that will be connected continuously, such as VCR or DVD players. For more information on connecting equipment, see pages 9-14. The product color and shape may vary depending on the model.

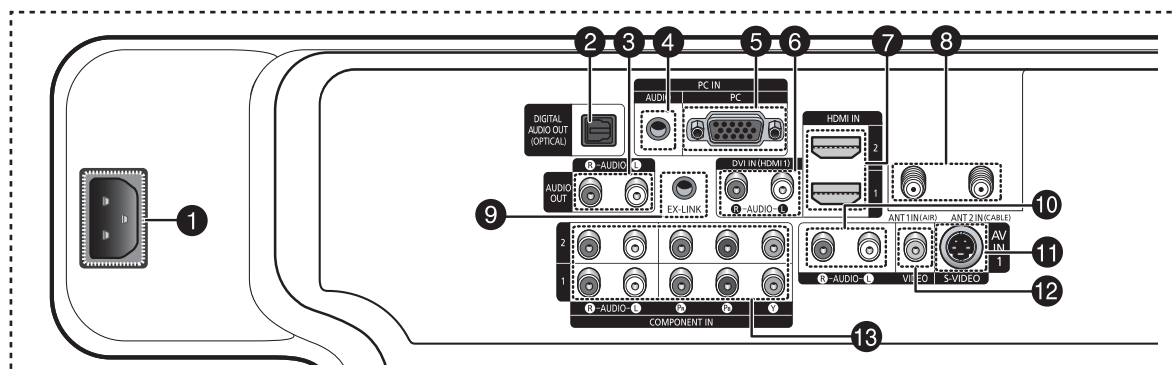

- 1 POWER IN**  
Connect the supplied power cord.
- 2 DIGITAL AUDIO OUT (OPTICAL)**  
Connect to a Digital Audio component.
- 3 AUDIO OUT (R/L)**  
Audio outputs to external devices.
- 4 PC AUDIO IN**  
Connect to the audio output jack on your PC.
- 5 PC IN**  
Connect to the video output jack on your PC.
- 6 DVI IN (HDMI 1) (AUDIO-R/L)**  
Connect to the DVI audio output jack of an external device.
- 7 HDMI IN 1, 2**  
Connect to the HDMI jack of a device with HDMI output. (Only HDMI 1 can support HDMI-DVI IN and PC.) This input can also be used as a DVI connection with separate analog audio inputs. An optional HDMI/DVI cable will be necessary to make this connection. When using an optional HDMI/DVI adapter, the DVI analog audio inputs on your TV allow you to receive left and right audio from your DVI device. (Not compatible with PC)
- 8 ANT 1 IN(AIR)/ANT 2 IN(CABLE)**  
75Ω Coaxial connector for Air/Cable Network.
- 9 EX-LINK**  
Connect this to the jack on the optional wall mount bracket. This will allow you to adjust the TV viewing angle using your remote control.
- 10 AUDIO-R/L (AV IN 1)**  
Audio inputs for external devices, such as a camcorder or VCR.
- 11 S-VIDEO (AV IN 1)**  
S-Video input for external devices with an S-Video output, such as a camcorder or VCR.
- 12 VIDEO (AV IN 1)**  
Video input for external devices, such as a camcorder or VCR.
- 13 COMPONENT IN 1, 2**  
Component video (Y/P<sub>B</sub>/P<sub>R</sub>) and audio (R-AUDIO-L) inputs.

### Side Panel Jacks

Use the right side panel jacks to connect a component that is used only occasionally, such as a camcorder or video game. The product color and shape may vary depending on the model.

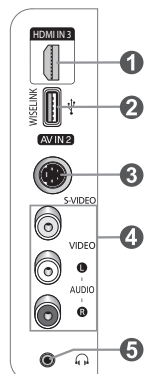

- 1 HDMI IN 3**  
Connect to the HDMI jack of a device with HDMI output.
- 2 WISELINK**  
Connect an USB mass storage device to view photo files (JPEG) and play audio files (MP3).
- 3 S-VIDEO IN 2**  
S-Video input for external devices with an S-Video output.
- 4 AV IN 2**  
Video and audio inputs for external devices.
- 5 HEADPHONE**  
You can connect a set of headphones if you wish to watch a television program without disturbing other people in the room.

# Remote Control

You can use the remote control up to a distance of about 23 feet from the TV. When using the remote, always point it directly at the TV. You can also use your remote control to operate your VCR, Cable box, DVD player, or Set-Top Box.

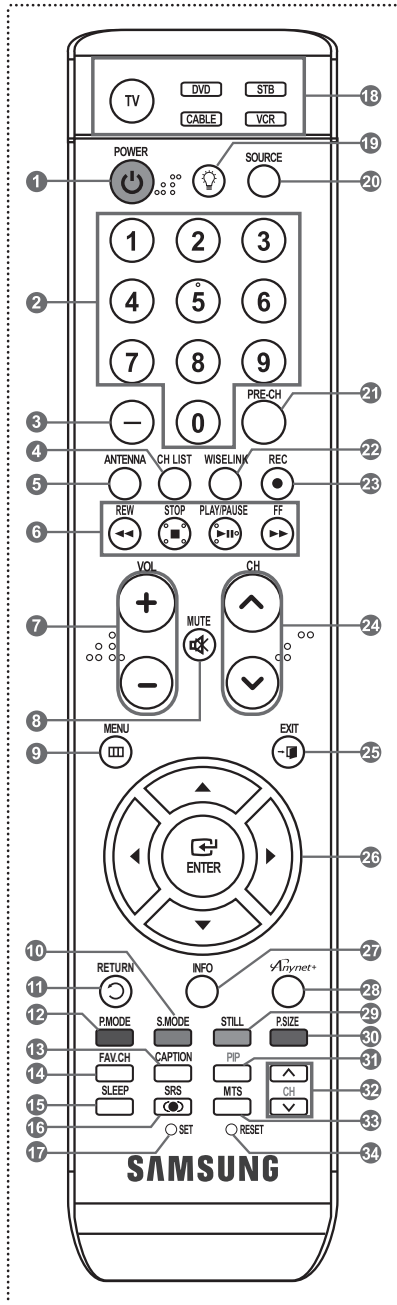

- This is a special remote control for the visually impaired, and has Braille points on the **POWER**, Channel, Volume, **STOP**, and **PLAY/PAUSE** buttons.
- The performance of the remote control may be affected by bright light.

- 1 POWER**  
Turns the TV on and off.
- 2 NUMERIC BUTTONS**  
Press to directly select a channel.
- 3 -**  
Press to select additional channels (digital and analog) being broadcast by the same station. For example, to select channel "54-3", press "54", then press "-" and "3".
- 4 CH LIST**  
Used to display Channel Lists on the screen.
- 5 ANTENNA**  
Press to select "AIR" or "CABLE".
- 6 VCR/DVD Functions**  
- Rewind  
- Stop  
- Play/Pause  
- Fast/Forward
- 7 + VOL -**  
Press to increase or decrease the volume.
- 8 MUTE**  
Press to temporarily cut off the sound.
- 9 MENU**  
Displays the main on-screen menu.
- 10 S.MODE**  
Press to select the sound mode.
- 11 RETURN**  
Returns to the previous menu.
- 12 P.MODE**  
Press to select the picture mode.
- 13 CAPTION**  
Controls the caption decoder.
- 14 FAV.CH**  
Press to switch to your favorite channels.
- 15 SLEEP**  
Press to select a preset time interval for automatic shut off.
- 16 SRS**  
Selects SRS TruSurround XT mode.
- 17 SET**  
Sets the remote to control your TV, VCR, Cable, DVD, or Set-Top Box.
- 18 TV/DVD/STB/CABLE/VCR**  
Press to operate your TV, DVD, STB, CABLE (box), or VCR.
- 19** Press to backlight the VOL, CH, and active source button (TV, DVD, CABLE, STB, VCR) on the remote.
- 20 SOURCE**  
Press to display all of the available video sources.
- 21 PRE-CH**  
Tunes to the previous channel.
- 22 WISELINK**  
This function enables you to view and play photo (JPEG) and audio files (MP3) from an external device. (Refer to page 63 (JPEG), 69 (MP3))
- 23 REC**  
This remote can be used to control recording on Samsung recorders. (Refer to page 74)
- 24 ^ CH v**  
Press to change channels.
- 25 EXIT**  
Press to exit the menu.
- 26 UP ▲/DOWN ▼/LEFT ◀/RIGHT ▶/ENTER** Use to select on-screen menu items and change menu values.
- 27 INFO**  
Press to display information on the TV screen.
- 28 Anynet+**  
Runs the Anynet+ view functions and sets up Anynet+ devices.
- 29 STILL**  
Press to stop the action during a particular scene. Press again to resume normal video.
- 30 P.SIZE**  
Press to change the screen size.
- 31 PIP**  
Picture-in Picture ON/OFF.
- 32 CH ^/v**  
Displays the available channels in sequence. (These buttons change channels in the PIP window only.)
- 33 MTS**  
Press to choose stereo, mono or Separate Audio Program (SAP broadcast).
- 34 RESET**  
When your remote does not work, change the batteries and press the RESET button for 2-3 seconds before use.



## Installing Batteries in the Remote Control

- 1 Lift the cover at the back of the remote control upward as shown in the figure.
  - 2 Install two AAA size batteries.
    - Make sure to match the “+” and “-” ends of the batteries with the diagram inside the compartment.
    - Do not mix battery types, i.e. alkaline and manganese.
  - 3 Close the cover as shown in the figure.
    - Remove the batteries and store them in a cool, dry place if you won't be using the remote control for a long time. The remote control can be used up to about 23 feet (7m) from the TV. (Assuming typical TV usage, the batteries last for about one year.)
- **If the remote control doesn't work, check the following:**
1. Is the TV power on?
  2. Are the plus and minus ends of the batteries reversed?
  3. Are the batteries drained?
  4. Is there a power cut, or is the power cord unplugged?
  5. Is there a special fluorescent light or a neon sign nearby?

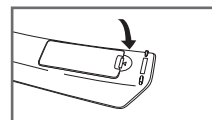
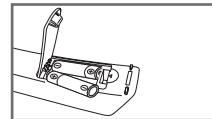
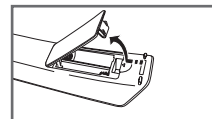

## Connections

### Connecting VHF and UHF Antennas

If your antenna has a set of leads that look like this, see “Antennas with 300  $\Omega$  Flat Twin Leads” below.

If your antenna has one lead that looks like this, see “Antennas with 75  $\Omega$  Round Leads”.  
If you have two antennas, see “Separate VHF and UHF Antennas”.

#### Antennas with 300 $\Omega$ Flat Twin Leads

If you are using an off-air antenna (such as a roof antenna or “rabbit ears”) that has 300  $\Omega$  twin flat leads, follow the directions below.

- 1 Place the wires from the twin leads under the screws on a 300-75  $\Omega$  adaptor (not supplied). Use a screwdriver to tighten the screws.
- 2 Plug the adaptor into the ANT 1 IN (AIR) or ANT 2 IN (CABLE) terminal on the back of the TV.

#### Antennas with 75 $\Omega$ Round Leads

- 1 Plug the antenna lead into the ANT 1 IN (AIR) or ANT 2 IN (CABLE) terminal on the back of the TV.

#### Separate VHF and UHF Antennas

If you have two separate antennas for your TV (one VHF and one UHF), you must combine the two antenna signals before connecting the antennas to the TV. This procedure requires an optional combiner-adaptor (available at most electronics shops).

- 1 Connect both antenna leads to the combiner.
- 2 Plug the combiner into the ANT 1 IN (AIR) or ANT 2 IN (CABLE) terminal on the bottom of the back panel.

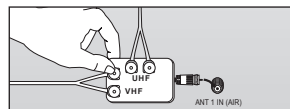
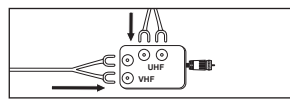
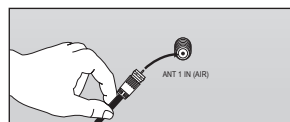
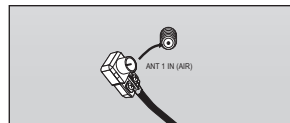
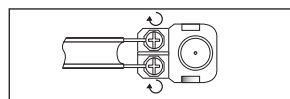
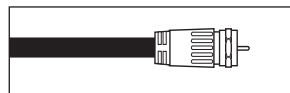
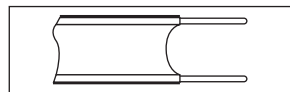

# Connecting Cable TV

To connect to a cable TV system, follow the instructions below.

## Cable without a Cable Box

- 1 Plug the incoming cable into the ANT 2 IN(CABLE) terminal on the back of the TV.
  - Because this TV is cable-ready, you do not need a cable box to view unscrambled cable channels.

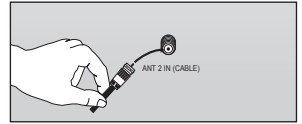

## Connecting to a Cable Box that Descrambles All Channels

- 1 Find the cable that is connected to the ANT OUT terminal on your cable box.
  - This terminal might be labeled “ANT OUT”, “VHF OUT” or simply, “OUT”.
- 2 Connect the other end of this cable to the ANT 2 IN(CABLE) terminal on the back of the TV.

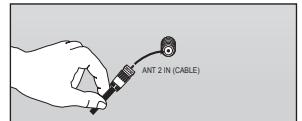
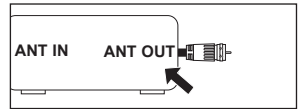

## Connecting to a Cable Box that Descrambles Some Channels

If your cable box descrambles only some channels (such as premium channels), follow the instructions below. You will need a two-way splitter, an RF (A/B) switch, and four lengths of Antenna cable. (These items are available at most electronics stores.)

- 1 Find and disconnect the cable that is connected to the ANT IN terminal on your cable box.
  - This terminal might be labeled “ANT IN”, “VHF IN” or simply, “IN”.
- 2 Connect this cable to a two-way splitter.
- 3 Connect an Antenna cable between an OUTPUT terminal on the splitter and the IN terminal on the cable box.
- 4 Connect an Antenna cable between the ANT OUT terminal on the cable box and the B-IN terminal on the RF(A/B) switch.
- 5 Connect another cable between the other OUT terminal on the splitter and the A-IN terminal on the RF (A/B) switch.
- 6 Connect the last Antenna cable between the OUT terminal on the RF (A/B) switch and the ANT 2 IN (CABLE) terminal on the rear of the TV.

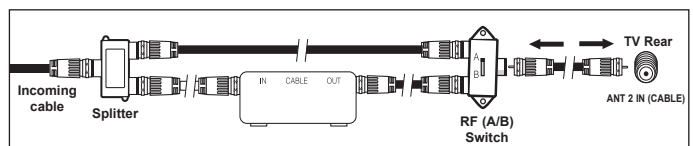
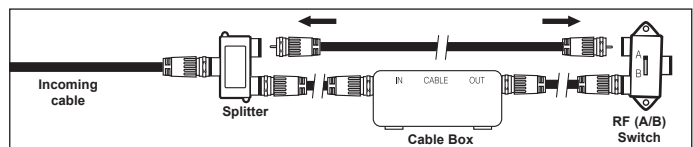
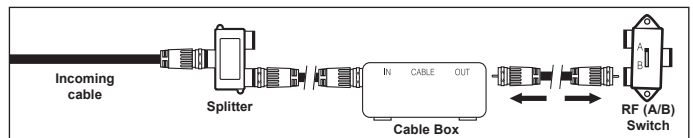
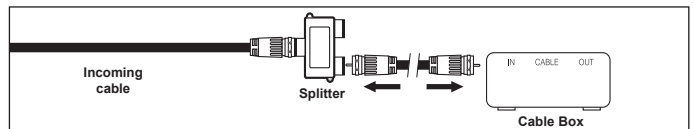
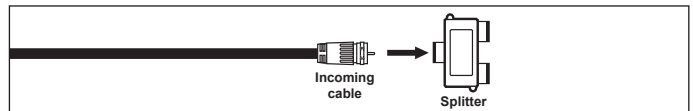
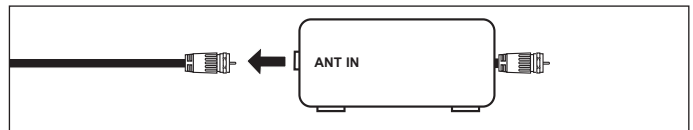

After you have made this connection, set the A/B switch to the “A” position for normal viewing. Set the A/B switch to the “B” position to view scrambled channels. (When you set the A/B switch to “B”, you will need to tune your TV to the cable box’s output channel, which is usually channel 3 or 4.)

# Connecting a VCR

## Video Connection

These instructions assume that you have already connected your TV to an antenna or a cable TV system (according to the instructions on pages 9~10). Skip step 1 if you have not yet connected to an antenna or a cable system.

- 1 Unplug the cable or antenna from the back of the TV.
- 2 Connect the cable or antenna to the ANT IN terminal on the back of the VCR.
- 3 Connect an Antenna Cable between the ANT OUT terminal on the VCR and the ANT 1 IN(AIR) or ANT 2 IN (CABLE) terminal on the TV.
- 4 Connect a Video Cable between the VIDEO OUT jack on the VCR and the AV IN 1 [VIDEO] jack on the TV.
- 5 Connect Audio Cables between the AUDIO OUT jacks on the VCR and the AV IN 1 [R-AUDIO-L] jacks on the TV.

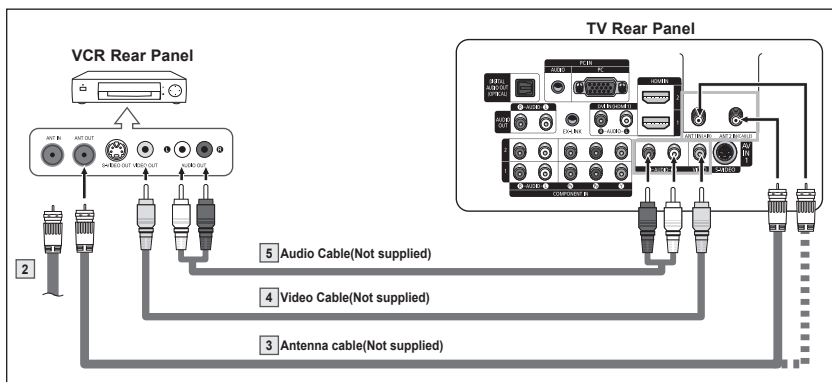
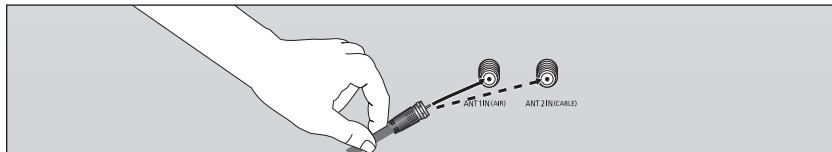

- If you have a “mono” (non-stereo) VCR, use a Y-connector (not supplied) to hook up to the right and left audio input jacks of the TV. If your VCR is stereo, you must connect two cables.

- Each VCR has a different back panel configuration.
- When connecting a VCR, match the color of the connection terminal to the cable.

## S-Video Connection

Your Samsung TV can be connected to the S-Video jack of a VCR. (This connection delivers a better picture when compared to the regular Video connection above.)

- 1 To begin, follow steps 1–3 in the previous section to connect the antenna or cable to your VCR and your TV.
- 2 Connect an S-Video Cable between the S-VIDEO OUT jack on the VCR and the AV IN 1 [S-VIDEO] jack on the TV.
- 3 Connect Audio Cables between the AUDIO OUT jacks on the VCR and the AV IN 1 [R-AUDIO-L] jacks on the TV.

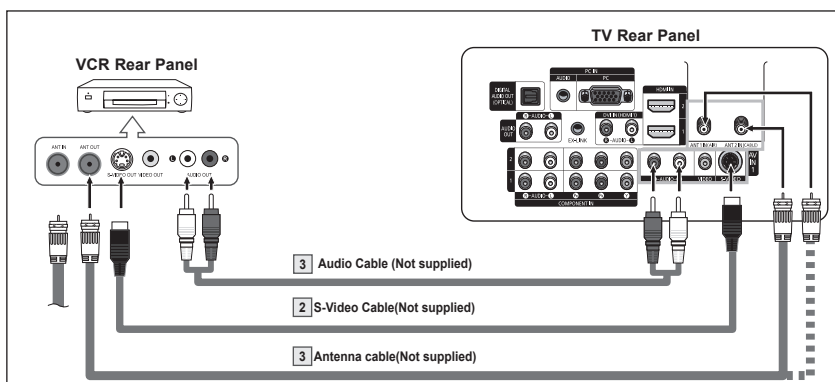

An S-Video may be included with your VCR. (If not, check your local electronics store.)

- Each VCR has a different back panel configuration.
- When connecting a VCR, match the color of the connection terminal to the cable.

## Connecting a Camcorder

The side panel jacks on your TV make it easy to connect a camcorder to your TV. They allow you to view the camcorder tapes without using a VCR

- 1 Connect a Video Cable (or S-Video Cable) between the AV IN 2 [VIDEO] (or S-VIDEO) jack on the TV and the VIDEO OUT jack on the Camcorder.
- 2 Connect Audio Cables between the AV IN 2 [L-AUDIO-R] jacks on the TV and the AUDIO OUT jacks on the Camcorder.

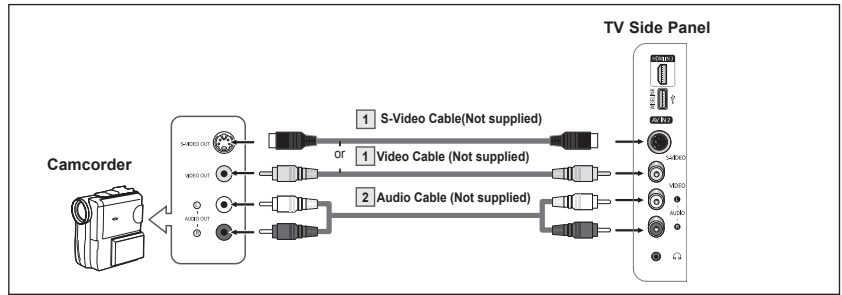

- Each Camcorder has a different back panel configuration.
- When connecting a Camcorder, match the color of the connection terminal to the cable.

## Connecting a DVD Player/Set-Top Box

The rear panel jacks on your TV make it easy to connect a DVD Player/Set-Top Box to your TV.

- 1 Connect Component Cables between the COMPONENT IN 1 [Y, P<sub>B</sub>, P<sub>R</sub>] (or COMPONENT IN 2 [Y, P<sub>B</sub>, P<sub>R</sub>]) jacks on the TV and the COMPONENT OUT [Y, P<sub>B</sub>, P<sub>R</sub>] jacks on the DVD Player/Set-Top Box.
- 2 Connect Audio Cables between the COMPONENT IN 1 [R-AUDIO-L] (or COMPONENT IN 2 [R-AUDIO-L]) jacks on the TV and the AUDIO OUT jacks on the DVD Player/Set-Top Box.

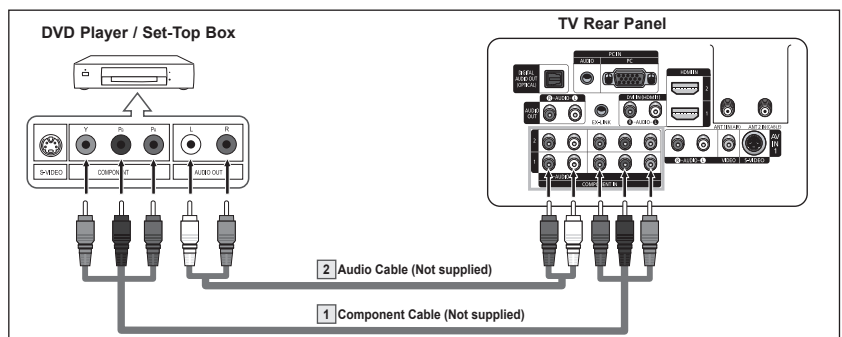

- Component video separates the video into Y (Luminance (brightness)), P<sub>B</sub> (Blue) and P<sub>R</sub> (Red) for enhanced video quality. Be sure to match the component video and audio connections. For example, if connecting the video cable to COMPONENT IN, connect the audio cable to COMPONENT IN also.
- Each DVD Player/Set-Top box has a different back panel configuration.
- When connecting a DVD Player/Set-Top box, match the color of the connection terminal to the cable.

## Connecting a DVD Player/Set-Top Box via HDMI

This connection can only be made if there is an HDMI Output jack on the external device. This connection will provide the highest quality picture.

- 1 Connect an HDMI Cable between the HDMI IN 2 on the TV and the HDMI OUT on the DVD Player/Set-Top Box.

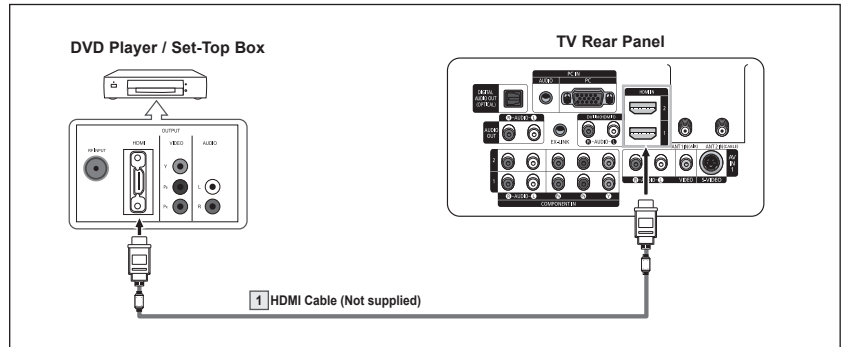

What is HDMI?

- HDMI, or high-definition multimedia interface, is an interface that enables the transmission of digital audio and video signals using a single cable without compression.
- The difference between HDMI and DVI is that the HDMI device is smaller in size and has the HDCP (High Bandwidth Digital Copy Protection) coding feature installed.
  - Each DVD Player/Set-Top box has a different back panel configuration.
  - When connecting a DVD Player/Set-Top box, match the color of the connection terminal to the cable.
  - When connecting via HDMI, you do not need to connect Audio Cables. You only need to connect Audio cables when connecting via HDMI/DVI.

## Connecting a DVD Player/Set-Top Box via DVI

This connection can only be made if there is a DVI Output jack on the external device.

- 1 Connect a HDMI/DVI Cable or DVI-HDMI Adapter between the [HDMI IN 1] jack on the TV and the DVI jack on the DVD Player/Set-Top Box.
- 2 Connect Audio Cables between the DVI IN (HDMI 1) [R-AUDIO-L] jack on the TV and the AUDIO OUT jacks on the DVD Player/Set-Top Box.

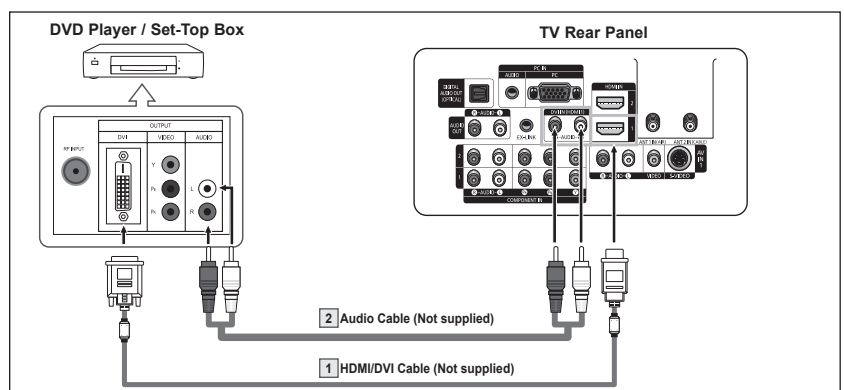

- Each DVD Player/Set-Top box has a different back panel configuration.
- When connecting a DVD Player/Set-Top box, match the color of the connection terminal to the cable.
- Only HDMI IN 1 can support HDMI and DVI.

## Connecting a Digital Audio System

The rear panel jacks on your TV make it easy to connect a Digital Audio System to your TV.

- 1 Connect an Optical Cable between the DIGITAL AUDIO OUT (OPTICAL) jacks on the TV and the Digital Audio Input (OPTICAL) jacks on the Digital Audio System.

When a Digital Audio System is connected to the "DIGITAL AUDIO OUT (OPTICAL)" terminal:  
Decrease the gain (volume) of the TV, and adjust the volume level with the system's volume control.

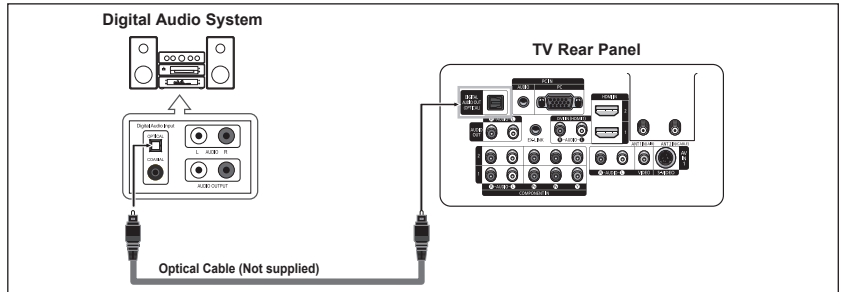

What is OPTICAL?

- Converts the electric signal into an optical light signal, and transmits it through glass fibers. S/PDIF is a transmission system of digital audio in the form of a light wave that uses a glass conductor.
- 5.1CH audio is possible when the TV is connected to an external device supporting 5.1CH.
- Each external input source device has a different back panel configuration.
- If you have an external device (DVD, Cable/Set-top box) connected via HDMI to the TV, audio is not output from the Optical jack.

## Connecting an Amplifier/DVD Home Theater

- 1 Connect Audio Cables between the AUDIO OUT [R-AUDIO-L] on the TV and AUDIO IN [L-AUDIO-R] on the Amplifier/DVD Home Theater.

When an audio amplifier is connected to the "AUDIO OUT [R-AUDIO-L]" terminals:  
Decrease the gain (volume) of the TV, and adjust the volume level with the Amplifier's volume control.

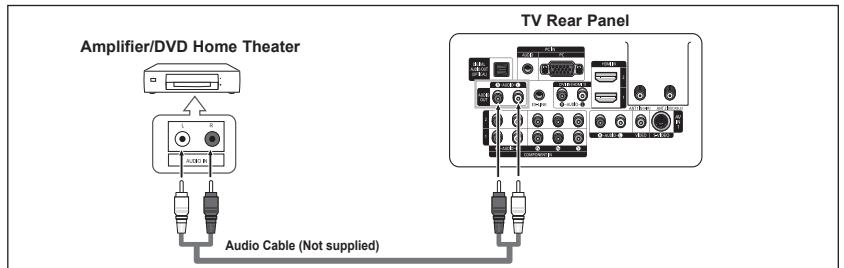

- Each Amplifier/DVD Home Theater has a different back panel configuration.
- When connecting an Amplifier/DVD Home Theater, match the color of the connection terminal to the cable.

## Connecting a PC

### Using the D-Sub Cable

- 1 Connect a D-Sub Cable between PC IN [PC] jack on the TV and the PC output jack on your computer.
- 2 Connect a PC Audio Cable between PC IN [AUDIO] jack on the TV and the Audio Out jack of the sound card on your computer.

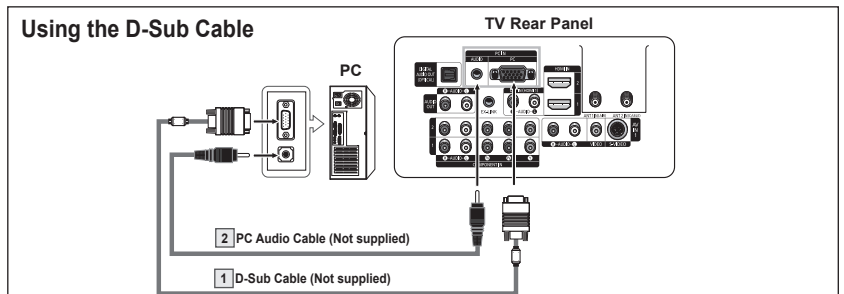

### Using the HDMI/DVI Cable

- 1 Connect a HDMI/DVI cable between the [HDMI IN 1] jack on the TV and the PC output jack on your computer.
- 2 Connect a 1Stereo/2RCA cable between the DVI IN (HDMI 1) [R-AUDIO-L] jack on the TV and the Audio Out jack of the sound card on your computer.

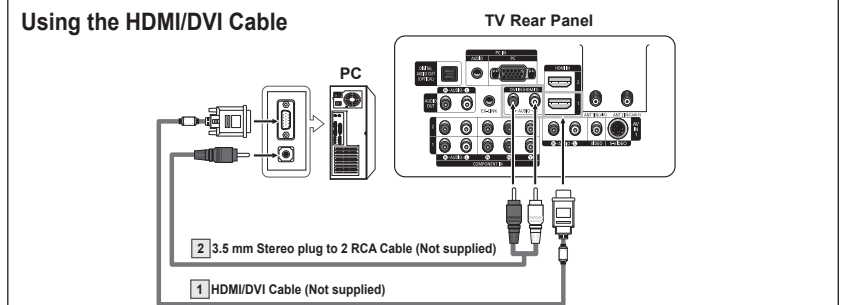

- Each PC has a different back panel configuration.
- When connecting a PC, match the color of the connection terminal to the cable.
- When using an HDMI/DVI cable connection, you must use the HDMI IN1 terminal.

# Operation

## Turning the TV On and Off

Press the **POWER** button on the remote control.  
You can also use the **POWER** button on the TV.

- It may take a while when your TV starts.

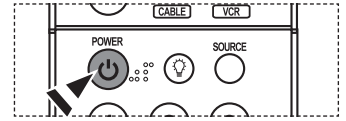

## Plug & Play Feature

When the TV is initially powered On, basic settings proceed automatically and subsequently:

- 1 Press the **POWER** button on the remote control.  
The message **Menu language, Shop Mode, Channels and Time will be set.** is displayed.
- 2 Press the **ENTER** button to enter the language.  
Press the **▲** or **▼** button to select language, then press the **ENTER** button.  
The message **Select Home Mode when installing this TV at home.** is automatically displayed.
- 3 Press the **◀** or **▶** button to select **Shop** or **Home**, then press the **ENTER** button.
  - The default selection is Home.
  - We recommend setting the TV to Home mode for the best picture in your home environment.
  - Shop mode is only intended for use in retail environments.
  - If the unit is accidentally set to Shop mode and you want to return to Dynamic (Home) mode, press the Volume button and then hold down the **MENU** button for five seconds on the TV panel.
- 4 Press the **▲** or **▼** button to memorize the channels of the selected connection.  
Press the **ENTER** button to select **Start**.
  - If the antenna is connected to ANT1 IN(AIR), select **Air** and if it is connected to ANT 2 IN(CABLE), select **Cable**.
  - If both ANT 1 IN(AIR) and ANT 2 IN(CABLE) are connected, select the **Air + Cable**.
  - In Cable mode, select the correct analog signal cable system source from among STD, HRC, and IRC by pressing the **▲** or **▼** button, then press the **ENTER** button. If you have Digital cable TV, select the cable system signal source for both Analog and Digital. Contact your local cable company to identify the type of cable system that exists in your particular area. To memorize the channels, press the **▶** button to select **Start**, then press the **ENTER** button.  
Contact your local cable company to identify the type of cable system that exists in your particular area.

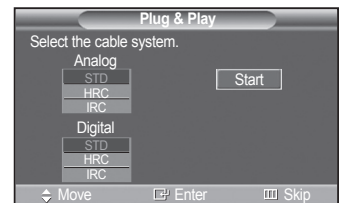
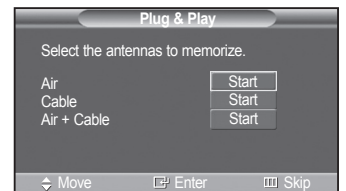
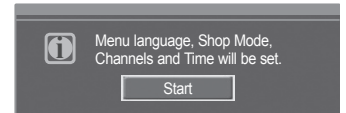

*Continued...*

- 5 The TV will begin memorizing all of the available channels. After all the available channels are stored, the Auto program menu reappears. Press the **ENTER** button when channel memorization is complete. **Clock Mode** menu is automatically displayed.

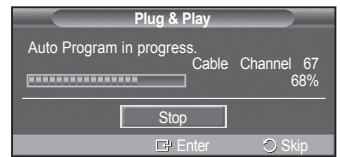

- To stop the search before it has finished, press the **ENTER** button with Stop selected.

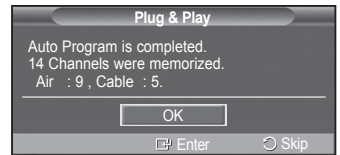

- 6 Press the **ENTER** button. Press the **▲** or **▼** button to select **Manual** if you want to set the current time manually, then press the **ENTER** button. **Set current date and time.** is displayed.

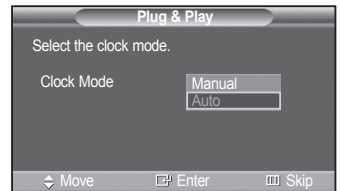

- If you select **Auto**, **Set to daylight savings time.** is displayed, then go to step 9.

- 7 Press the **◀** or **▶** button to move to **Month, Day, Year, Hour, Minute,** or **am/pm.** Set the date and time you want by pressing the **▲** or **▼** button, then press the **MENU** button.

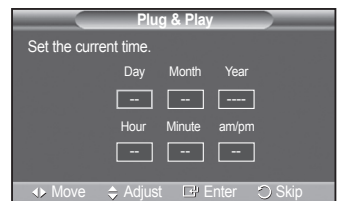

- You can set the **Month, Day, Year, Hour,** and **Minute** directly by pressing the number buttons on the remote control.

- 8 The message **Enjoy your watching.** is displayed. When you have finished, press the **ENTER** button.

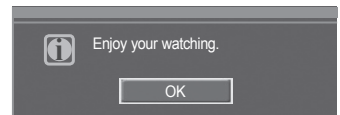

- Even if the **ENTER** button is not pressed, the message will automatically disappear after several seconds.

### Setting the Clock Automatically

- 9 Press the **ENTER** button. Press the **▲** or **▼** button to select **On** or **Off**, then press the **ENTER** button. **Select the time zone in which you live.** menu is automatically displayed.

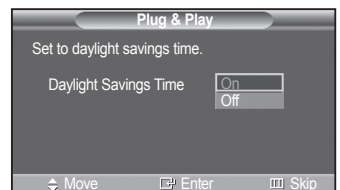

- 10 Press the **▲** or **▼** button to highlight the time zone for your local area (and to move the highlight to the appropriate time zone on the map of the United States).



- Press the **ENTER** button. If clock is not automatically set, see page 48 to set the clock.

- 11 The message **Enjoy your watching.** is displayed. When you have finished, press the **ENTER** button.

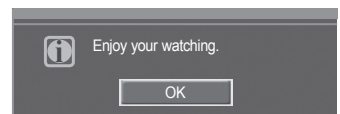

- Even if the **ENTER** button is not pressed, the message will automatically disappear after several seconds.

*Continued...*



### If you want to reset this feature...

- 1 Press the **MENU** button to display the menu.  
Press the **▲** or **▼** button to select **Setup**, then press the **ENTER** button.
- 2 Press the **ENTER** button to select **Plug & Play**. For further details on setting up options, refer to the page 15~16.
  - The Plug & Play feature is only available in the TV and DTV mode.



## Changing Channels

### Using the Channel Buttons

- 1 Press the **CH ▲** or **CH ▼** button to change channels.
  - When you press the **CH ▲** or **CH ▼** button, the TV changes channels in sequence. You will see all the channels that the TV has memorized. (The TV must have memorized at least three channels). You will not see channels that were either erased or not memorized. See page 19 to memorize channels.

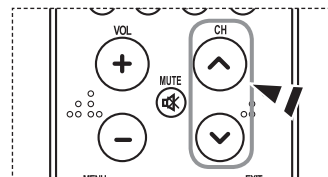

### Using the Number Buttons

- 1 Press the number buttons to go directly to a channel. For example, to select channel 27, press **2**, then **7**.  
The TV will change channels when you press the second number.

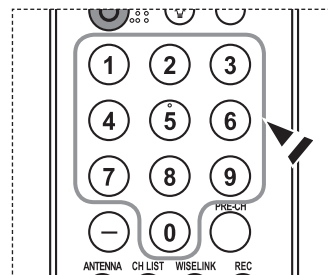

### Using the “-” Button

The “-” button is used to select stations that broadcast a digital signal.

- 1 For example, for Channel 7-1, press **7**, then **-**, then **1**.
  - HD indicates the TV is receiving a Digital High Definition signal.
  - SD indicates the TV is receiving a Standard Definition signal.
  - For quick channel change, press the number buttons, then press the **ENTER** button.

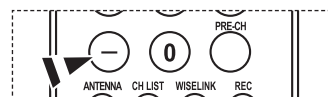

### Using the PRE-CH Button to select the Previous Channel

Use the number buttons to quickly tune to any channel.

- 1 Press the **PRE-CH** button. The TV will switch to the last channel viewed.
  - To quickly switch between two channels that are far apart, tune to one channel, then use the number button to select the second channel. Then use the **PRE-CH** button to quickly alternate between them.

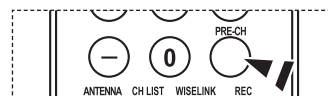

## Adjusting the Volume

### Using the Volume Buttons

- 1 Press the **VOL +** or **VOL -** button to increase or decrease the volume.

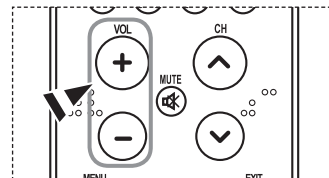

### Using the Mute Button

At any time, you can cut off the sound using the **MUTE** button.

- 1 Press **MUTE** and the sound cuts off.  
The word "Mute" will appear in the lower-left corner of the screen.
- 2 To turn mute off, press the **MUTE** button again, or simply press the **VOL +** or **VOL -** button.



## Viewing the Display

The display identifies the current channel and the status of certain audio-video settings.

- 1 Press the **INFO** button on the remote control.  
The TV will display the channel, the type of sound, and the status of certain picture and sound settings.  
 Press the **INFO** button once more or wait approximately 10 seconds and it disappears automatically.

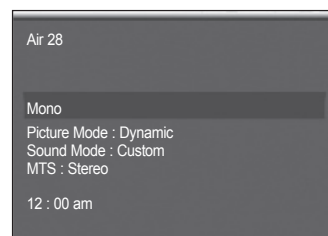

## Viewing the Menus

- 1 With the power on, press the **MENU** button.  
The main menu appears on the screen. Its left side has five icons: **Picture**, **Sound**, **Channel**, **Setup**, **Input**.
  - 2 Use the **▲** or **▼** button to select one of the five icons.  
Then press the **ENTER** button to access the icon's sub-menu.
  - 3 Press the **EXIT** button to exit.
- It takes about one minute until the on-screen menu disappears.

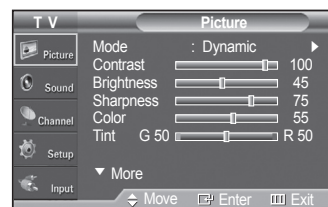

## Memorizing the Channels

Your TV can memorize and store all of the available channels for both “off-air” (air) and cable channels. After the available channels are memorized, use the CH  $\wedge$  or CH  $\vee$  button to scan through the channels. This eliminates the need to change channels by entering the channel digits. There are three steps for memorizing channels: selecting a broadcast source, memorizing the channels (automatic) and adding and deleting channels (manual).

### Selecting the Video Signal-source

Before your television can begin memorizing the available channels, you must specify the type of signal source that is connected to the TV (i.e. an air or a cable system).

- 1 Press the **MENU** button to display the menu.  
Press the  $\blacktriangle$  or  $\blacktriangledown$  button to select **Channel**, then press the **ENTER** button.
- 2 Press the **ENTER** button select **Antenna**.  
Press the  $\blacktriangle$  or  $\blacktriangledown$  button to select **Air** or **Cable**, then press the **ENTER** button.  
Press the **EXIT** button to exit.

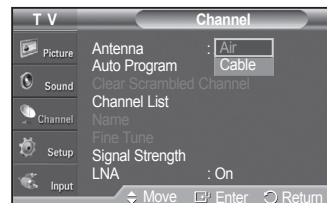

### Storing Channels in Memory (Automatic Method)

- 1 Press the **MENU** button to display the menu.  
Press the  $\blacktriangle$  or  $\blacktriangledown$  button to select **Channel**, then press the **ENTER** button.
- 2 Press the  $\blacktriangle$  or  $\blacktriangledown$  button to select **Auto Program**, then press the **ENTER** button.
- 3 Press the  $\blacktriangle$  or  $\blacktriangledown$  button to select the antenna connection, then press the **ENTER** button.
  - **Air**: “Air” antenna signal.
  - **Cable**: “Cable” antenna signal.
  - **Air+Cable**: “Air” and “Cable” antenna signals.
  - If the antenna is connected to ANT 2 IN (CABLE), select **Cable** and if it is connected to ANT 1 IN (AIR), select **Air**.
  - If both ANT 1 IN and ANT 2 IN are connected, select the **Air + Cable**.
  - If you selected **Air**, then go to step 5.
- 4 Press the  $\blacktriangle$  or  $\blacktriangledown$  to select the correct analog signal cable system source from among STD, HRC, and IRC, then press the **ENTER** button. If you have Digital cable TV, select the cable system signal source for both Analog and Digital.
  - If you have Digital cable TV, select the signal source for both Analog and Digital.
  - STD, HRC, and IRC identify various types of cable TV systems. Contact your local cable company to identify the type of cable system that exists in your particular area. At this point the signal source has been selected.
- 5 The TV begins memorizing all available stations.  
If you want to stop Auto Programming, press the **ENTER** button. The **Stop Auto Program?** message will be displayed. Select **Yes** by pressing the  $\blacktriangleleft$  or  $\blacktriangleright$  button.

Press the **EXIT** button to exit.

- The TV must be connected to antenna/cable in order to receive digital TV signals. Even if a particular channel is deleted from the memory, you can always tune to that channel directly by using the number buttons on the remote control.
- • All available DTV and analog channels are automatically stored in memory.
- It takes approximately 3 to 10 minutes to memorize channels.

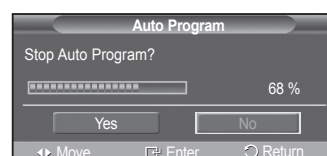
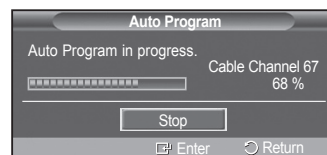
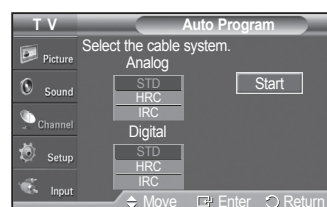
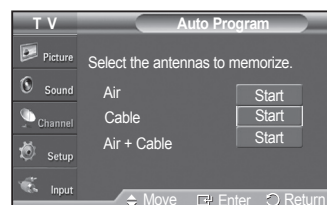

## Setting Up Your Remote Control

After your remote control has been properly set up, your remote control can operate in five different modes: TV, VCR, Cable, DVD, or Set-Top Box. Pressing the corresponding button on the remote control allows you to switch among these modes, and control whichever piece of equipment you choose.

➤ The remote control might not be compatible with all DVD Players, VCRs, Cable boxes, and Set-Top Boxes.

### Setting Up the Remote to Operate Your VCR

- 1 Turn off your VCR.
- 2 Press the **VCR** button on your TV's remote control.
- 3 Press the **SET** button on your TV's remote control.
- 4 Using the number buttons on your remote control, enter three digits of the VCR code listed on page 22 of this manual for your brand of VCR. Make sure you enter three digits of the code, even if the first digit is a "0". (If more than one code is listed, try the first one.)
- 5 Press the **POWER** button on the remote control. Your VCR should turn on if your remote is set up correctly.

If your VCR does not turn on after set-up, repeat steps 2, 3 and 4, but try one of the other codes listed for your brand of VCR. If no other codes are listed, try each VCR code, 000 through 080.

Note on Using Remote Control Modes: VCR

When your remote control is in **VCR** mode, the volume buttons still control your TV's volume.

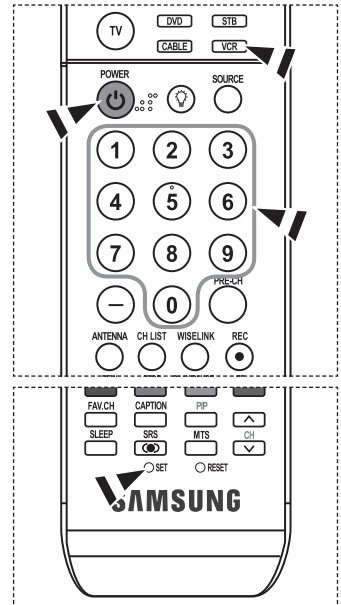

### Setting Up the Remote to Operate Your Cable Box

- 1 Turn off your cable box.
- 2 Press the **CABLE** button on your TV's remote control.
- 3 Press the **SET** button on your TV's remote control.
- 4 Using the number buttons on your remote control, enter three digits of the cable box code listed on page 23 of this manual for your brand of cable box. Make sure you enter three digits of the code, even if the first digit is a "0". (If more than one code is listed, try the first one.)
- 5 Press the **POWER** button on the remote control. Your cable box should turn on if your remote is set up correctly.

If your cable box does not turn on after set-up, repeat steps 2, 3 and 4, but try one of the other codes listed for your brand of cable box. If no other codes are listed, try each code, 000 through 046.

Note on Using Remote Control Modes: Cable Box

When your remote control is in **CABLE** mode, the volume buttons still control your TV's volume.

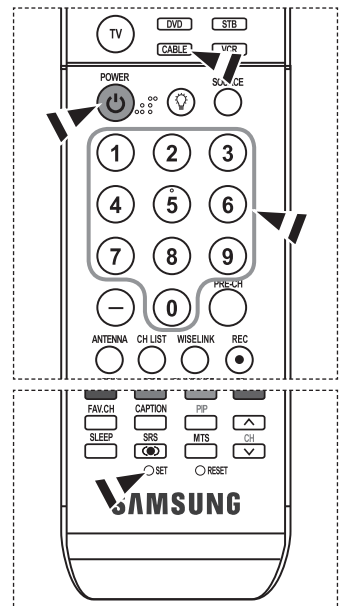

*Continued...*

## Setting Up the Remote to Operate Your DVD

- 1 Turn off your DVD.
- 2 Press the **DVD** button on your TV's remote control.
- 3 Press the **SET** button on your TV's remote control.
- 4 Using the number buttons on your remote control, enter three digits of the DVD code listed on page 24 of this manual for your brand of DVD. Make sure you enter three digits of the code, even if the first digit is a "0". (If more than one code is listed, try the first one.)
- 5 Press the **POWER** button on the remote control.  
Your DVD should turn on if your remote is set up correctly.

If your DVD does not turn on after set-up, repeat steps 2, 3 and 4, but try one of the other codes listed for your brand of DVD. If no other codes are listed, try each code, 000 through 141.

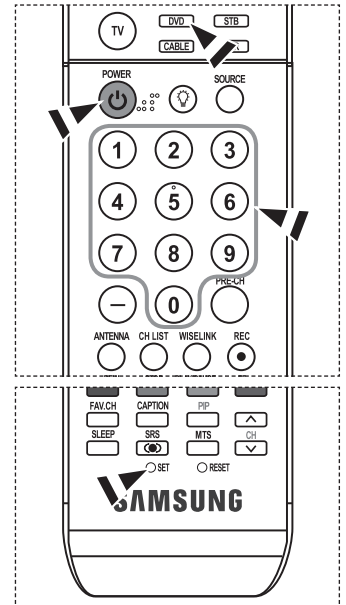

### Note on Using Remote Control Modes: DVD

When your remote control is in **DVD** mode, the volume buttons still control your TV's volume.

## Setting Up the Remote to Operate Your Set Top Box

- 1 Turn off your STB.
- 2 Press the **STB** button on your TV's remote control.
- 3 Press the **SET** button on your TV's remote control.
- 4 Using the number buttons on your remote control, enter three digits of the STB code listed on page 23 of this manual for your brand of STB. Make sure you enter three digits of the code, even if the first digit is a "0". (If more than one code is listed, try the first one.)
- 5 Press the **POWER** button on the remote control.  
Your STB should turn on if your remote is set up correctly.

If your STB does not turn on after set-up, repeat steps 2, 3 and 4, but try one of the other codes listed for your brand of STB. If no other codes are listed, try each code, 000 through 074.

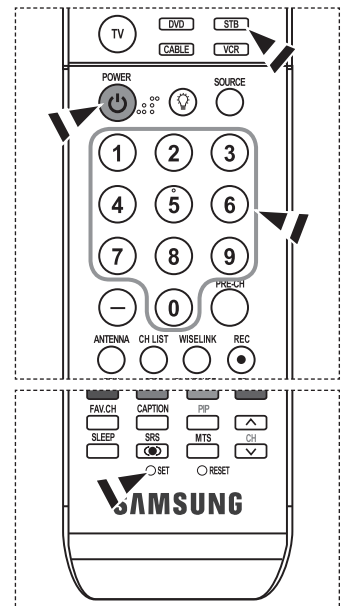

### Note on Using Remote Control Modes: STB

When your remote control is in **STB** mode, the volume buttons still control your TV's volume.

## Remote Control Codes

### VCR

Brand	Code
SAMSUNG	000 001 002 003 004 005 077 078 079
ADMIRAL	020
AIWA	025
AKAI	004 027 032
AUDIO DYNAMICS	007 026
BELL&HOWELL	018
BROKSONIC	022
CANDLE	002 003 006 008 015 055
CANON	021 056
CITIZEN	002 003 006 008 015 055
COLORTYME	007
CRAIG	002 024
CURTIS MATHES	002 007 008 017 021 025 056 064 066
DAEWOO	003 010 011 012 013 014 015 016
DB	007 026
DIMENSIA	017
DYNATECH	025
ELECTROHOME	034
EMERSON	001 003 006 021 022 025 030 032 034 040 047 050 052 060 063 065 066 067 069 073
FISHER	018 024 028 029 048 051 061
FUNAI	025
GENERAL ELECTRIC	002 005 017 021 056
GO VIDEO	002
LG(Goldstar)	006 007 008 009 010
HARMAN KARDON	007
HITACHI	019 025 041 042 074
INSTANT REPLAY	021
JC PENNEY	002 007 018 019 021 026 037 041 054 056
JCL	007 008 018 021 026 037
KENWOOD	007 008 018 026 037
KLH	070
LLOYD	025
LOGIK	038
LXI	025
JVC	081 082 083
MAGNAVOX	021 056 059
MARANTZ	007 008 018 021 026 037 062
MARTA	006
KONIA	036
ORION	073 074 075 076
MEI	021
MEMOREX	006 021 024 025
MGA	034
MIDLAND	005
MINOLTA	019 041 075

Brand	Code
mitsubishi	019 034 041 046
MONTGOMERY WARD	020
MTC	002 025
MULTITECH	002 005 025 038
NEC	007 008 018 026 037 062 064
OPTIMUS	020
PANASONIC	021 056 071 072
PENTAX	019 041 075
PENTEX RESEARCH+	008
PHILCO	021 056 059
PHILIPS	021 080
PIONEER	019 026 039 053
PORTLAND	015 049 055
PROSCAN	017
QUARTZ	018
QUASAR	021 056
RADIO SHACK/	006 018 020 021 024 025 029 034
REALISTIC	048 056
RCA	002 017 019 021 035 041 043 057 068 076
SANSUI	026
SANYO	018 024
SCOTT	003 047 052 067
SEARS	006 018 019 024 028 029 041 048 051
SHARP	020 034 045 015
SHIMTOM	027 033 038 058
SIGNATURE	025
SONY	027 033 044
SYLVANIA	021 025 056 059
SYMPHONIC	025
TANDY	018 025
TASHIKA	006
TATUNG	037
TEAC	025 037 068
TECHNICS	021
TEKNIKA	006 021 025 031
TMK	066
TOSHIBA	003 019 029 051 052
TOTEVISION	002 006
UNITECH	002
VECTOR RESEARCH	007 026
VICTOR	026
VIDEO CONCEPTS	007 026
VIDEOSONIC	002
WARDS	002 003 006 019 020 021 024 025 034 038 041
YAMAHA	007 008 018 026 037
ZENITH	023 027 033

*Continued...*

## CABLE BOX

Brand	Code
SAMSUNG	000 001 002 003 004 005 006 007
GI	041
HAMLIN	003 024 031
HITACHI	025 030
JERROLD	038 039
MACOM	025 030
MAGNAVOX	019 023 028
OAK	026
PANASONIC	003 022 027 037 044
PHILIPS	019 021 023 028
PIONEER	004 018 020 044
RCA	014 022 040
REGAL	003

Brand	Code
REGENCY	015 023
SA	042 043
SCIENTIFIC ATLAN	042 043
SPRUCER	022
STARGATE 2000	036
SYLVANIA	016
TEXSCAN	016
TOCOM	032
UNIVERSAL	033 034
VIEWSTAR	019 021 023 028
WARNER AMEX	046
ZENITH	017 029 035 037 045

## SAMSUNG SET-TOP BOX

Product	Code
Ground wave STB	001 002
Satellite STB	003
CABLE STB	004
STB DVD COMBO	008
Satellite STB HDD COMBO Standard	009

Product	Code
Satellite STB HDD COMBO Premium	010
CABLE STB HDD COMBO Standard	011
CABLE STB HDD COMBO Premium	012
Ground wave STB HDD COMBO Standard	013
Ground wave STB HDD COMBO Premium	014

## SET-TOP BOX

Brand	Code
ALPHASTAR	023
ANAM	043
CHANNEL MASTER	018 034
CROSSDIGITAL	019
CHAPARRAL	035
DIRECT TV	015 016 017 019 022 045 060 061 062 065 066 067 068
DAEWOO	074
DISH NETWORK SYSTEM	069 070
DISHPRO	069
DRAKE	018 024 032
DX ANTENNA	027
ECHOSTAR	025 069 070 071
EXPRESSVU	069
GOI	069
GE	065
GENERAL INSTRUMENT	046 047 048 063 064
HTS	069
HOME CABLE	056
HITACHI	022
HUGHES NETWORK	015 017
IQ	020
IQ PRISM	020
JANEIL	059
JERROLD	063
JVC	069 070

Brand	Code
LG(Goldstar)	044 073
MAGNAVOX	016 021 036 038 039 040 041 042
MEMOREX	016
MOTOROLA	064
MACOM	018
MITSUBISHI	015
NEXT LEVEL	047 048 064
PHILIPS	015 016 017 021 023 036 038 039 040 041 042 067
PRIMESTAR	046 049 050 063
PANASONIC	058 059 061 062
PAYSAT	016
PROSCAN	065 066
RCA	051 052 053 065 066
RADIOSHACK	064
REALISTIC	057
STS	020 027
STAR TRAK	026
SKY	031
SKY LIFE	005 006 007
SHACK	064
STAR CHOICE	064
SONY	054 060
TOSHIBA	015 017 028 029 030 072
ULTIMATE TV	060 066
UNIDEN	016 021 037 055 056 057
ZENITH	024 031 068

*Continued...*

## SAMSUNG DVD

Product	Code
DVD	000 001 002
DVDR	003 004
BD Record	005 006
VCR COMBO	007 008 009 010 011
VCR Record	012
DHR COMBO	013

Product	Code
Home Theater VCR COMBO	014 015 016
HDD Record COMBO	017
TWIN TRAY COMBO	018
STB DVD COMBO	019
DVD Receiver	020
AV Receiver	021

## DVD

Brand	Code
ANAM	030
AUDIOVOX	075
AUDIOLOGIC	085
ANABA	072
APEX DIGITAL	070 071 074 086 083 084 088 111 112
AIWA	114
BROKSONIC	062
BLAUPUNKT	074
B&K	122 123
CURTIS MATHES	027
CYBER HOME	065 077 078 079 082
CLARION	080 125
CIRRUS	081
CINEVISION	095
DAEWOO	066
DENON	146
FARENHEIT	067 068
FISHER	090
GPX	060
GO VIDEO	061 089 133 135
GE	069 074
GREENHILL	074
HITACHI	064 113
HITEKER	071
HOYO	073
HARMAN / KARDON	091 110
IRT	089
INTEGRA	092
JBL	091
JVC	022 033 115 116
JATON	073
KENWOOD	051 108 109
KISS	073
KONKA	059 100 106 107
KLH	074 075
LG(Goldstar)	025 031
LOEWE	057
LASONIC	058
MOBILE AUTHORITY	054
MEMOREX	055
MALATA	056
MAGNAVOX	076 093
MINTEK	074 094
MONYKA	073

Brand	Code
NORCENT	048 049 050
NEXT BASE	052
NEC	053
NANTAUS	144
NESA	074
OPTOMEDIA ELECTRONICS	105
OPTIVIEW	072
ONKYO	076 092 119
PHILCO	044 045
PRINCETON	046 047
PROSCAN	023
PANASONIC	024 034 124 134 136 137 138
PHILIPS	036 076
ROTEL	117 118
RIO	120
RCA	023 035 074 075 131 132
RAITE	073
ROWA	038
SAMPO	104
SONY	026 029 126 127 128 129 130 141
SHERWOOD	039 041
SVA	042
SYLVANIA	043 093
SHARP	140
SANSUI	062
SANYO	062
SHINSONIC	094
SANYO	090
THOMSON	145
TOSHIBA	028 062 076
TECHNICS	139
TVIEW	072
TOKAI	073
TEAC	096
TECHWOOD	097
TREDEX	098 099 101
URBAN CONCEPTS	076
VENTURER	075
VOCOPRO	102
YAMAHA	032 063
YAMAKAWA	040 073
XWAVE	103
ZENITH	076 121



## To Select the Source

Use to select TV or other external input sources such as DVD players or Set-top/Cable boxes connected to the TV.  
Use to select the input source of your choice.

- 1 Press the **MENU** button to display the menu.  
Press the **▲** or **▼** button to select **Input**, then press the **ENTER** button.
- 2 Press the **ENTER** button to select **Source List**.  
Press the **▲** or **▼** button to select signal source, then press the **ENTER** button.
  - You can choose between the following sets of jacks: AV1, S-Video1, Component1, Component2, PC, HDMI1, or HDMI2 on the TV's rear panel and AV2, S-Video2, or HDMI3 on the TV's side panel.
  - HDMI1, HDMI2, or HDMI3 input can only be selected when the external device is turned on and connected via HDMI.
  - You can choose only those external devices that are connected to the TV.

 You can also press the **SOURCE** button on the remote control to view an external signal source.

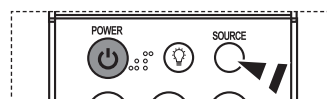
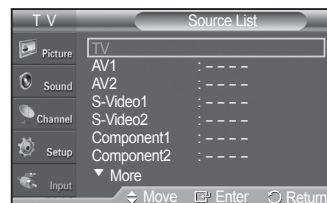
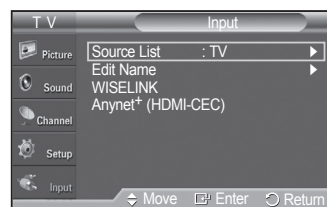

## To Edit the Input Source Name

You can name the device connected to the input jacks to make your input source selection easier.

- 1 Press the **MENU** button to display the menu.  
Press the **▲** or **▼** button to select **Input**, then press the **ENTER** button.  
Press the **▲** or **▼** button to select **Edit Name**, then press the **ENTER** button.
- 2 Press the **▲** or **▼** button to select **AV1, AV2, S-Video1, S-Video2, Component1, Component2, PC, HDMI1, HDMI2, or HDMI3** input jack, then press the **ENTER** button.
- 3 Press the **▲** or **▼** button to select **VCR, DVD, D-VHS, Cable STB, HD STB, Satellite STB, PVR STB, AV Receiver, DVD Receiver, Game, Camcorder, DVD Combo, PC, VOD STB, or TV** input source, then press the **ENTER** button.  
Press the **EXIT** button to exit.

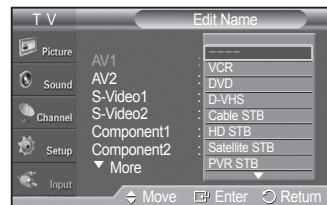
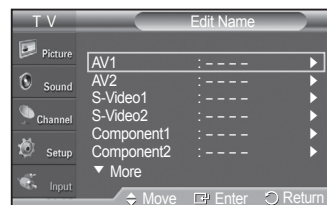
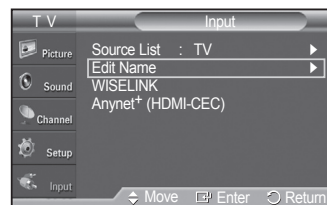

# Picture Control

## Using Automatic Picture Settings

Your TV has three automatic picture settings (“Dynamic”, “Standard”, and “Movie”) that are preset at the factory. You can activate either Dynamic, Standard, or Movie by making a selection from the menu.

- 1 Press the **MENU** button to display the menu.  
Press the **▲** or **▼** button to select **Picture**, then press the **ENTER** button.

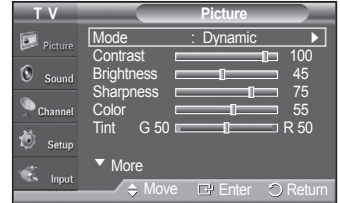

- 2 Press the **ENTER** button to select **Mode**.  
Press the **▲** or **▼** button to select the **Dynamic**, **Standard**, or **Movie** picture setting, then press the **ENTER** button.

- Choose **Dynamic** to increase the clarity and sharpness of the picture.
- Choose **Standard** for general TV watching mode.
- Choose **Movie** when watching movies.

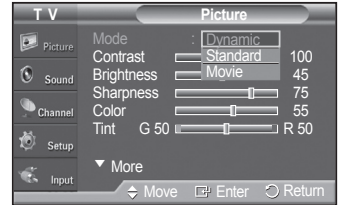

-  Press the **P.MODE** button on the remote control to select one of the standard picture settings.

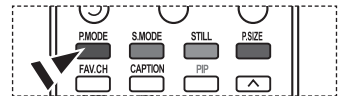

- 3 Press the **▲** or **▼** button to select **Contrast**, **Brightness**, **Sharpness**, **Color**, or **Tint**, then press the **ENTER** button.

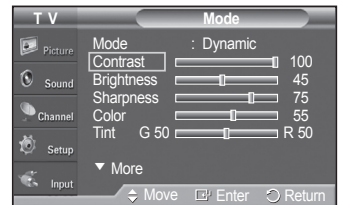

- 4 Press the **◀** or **▶** button to decrease or increase the value of a particular item.  
Press the **ENTER** button.
  - • **Tint** doesn't operate in PC mode.
  - In PC mode, only the **Contrast** and **Brightness** can be selected.
  - Each adjusted setting will be stored separately according to its input mode.
  - When you make changes to **Contrast**, **Brightness**, **Sharpness**, **Color**, or **Tint**. OSD color will also be adjusted accordingly.

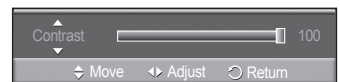

*Continued...*

- 5 Press the **ENTER** button to return to **Picture**.
- 6 Press the **▲** or **▼** button to select **Color Tone**, then press the **ENTER** button.
- 7 Press the **▲** or **▼** button to select **Cool2**, **Cool1**, **Normal**, **Warm1**, or **Warm2**, then press the **ENTER** button.
  - When the picture mode is set to **Dynamic** or **Standard**, **Warm1** and **Warm2** cannot be selected.

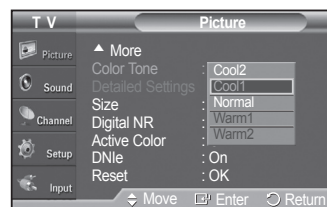
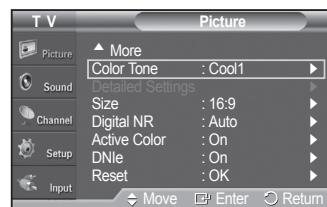

### Resetting the Picture Settings to the Factory Defaults

- 8 Press the **▲** or **▼** button to select **Reset**, then press the **ENTER** button. Press the **▲** or **▼** button to select **OK**, then press the **ENTER** button. Press the **EXIT** button to exit.
  - Each picture mode can be reset.

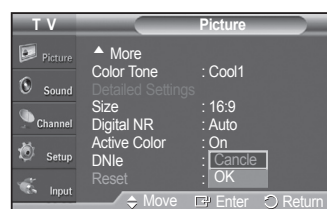

## Digital Noise Reduction

If the broadcast signal received by your TV is weak, you can activate the Digital Noise Reduction feature to help reduce any static and ghosting that may appear on the screen.

- 1 Press the **MENU** button to display the menu. Press the **▲** or **▼** button to select **Picture**, then press the **ENTER** button.
- 2 Press the **▲** or **▼** button to select **Digital NR**, then press the **ENTER** button.
- 3 Press the **▲** or **▼** button to select **Off**, **Low**, **Mediumm**, **High**, or **Auto**, then press the **ENTER** button. Press the **EXIT** button to exit.
  - The Digital NR function is available in all modes except PC.

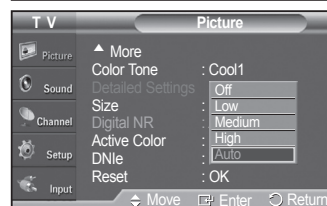
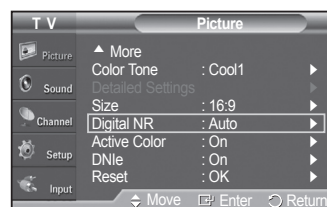

# Changing the Screen Size

Screen size selection depends on the type of video input.

- 1 Press the **MENU** button to display the menu.  
Press the **▲** or **▼** button to select **Picture**, then press the **ENTER** button.
- 2 Press the **▲** or **▼** button to select **Size**, then press the **ENTER** button.
- 3 Press the **▲** or **▼** button to select the screen format you want.  
Press the **ENTER** button.

Press the **EXIT** button to exit.

- **16:9** : Sets the picture to 16:9 wide mode.
- **Zoom1** : Magnifies the size of the picture on the screen.
- **Zoom2** : Expands the Zoom1 format picture.
- **Wide Fit** : Enlarges the aspect ratio of the picture to fit the entire screen.
- **4:3** : Sets the picture to 4:3 normal mode.
- **Just Scan** : Use this function to see the full image without any cutoff when DTV or HDMI 720p/1080i signals are input.

 Press the **P.SIZE** button on the remote control to change the picture size.

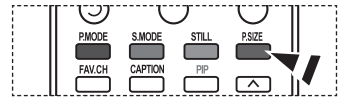
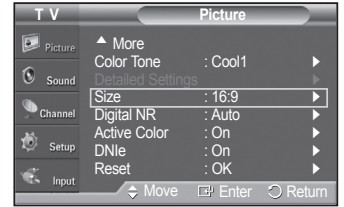

## 16:9

Sets the picture to 16:9 wide mode.

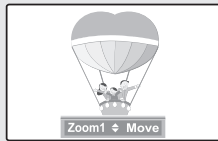

## Zoom1

The screen size when Wide screen is vertically enlarged.

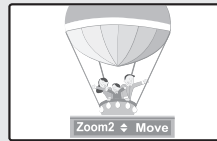

## Zoom2

The screen size when the Zoom1 screen is vertically enlarged.



## Wide Fit

Enlarges the aspect ratio of the picture to fit the entire screen.

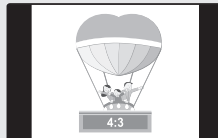

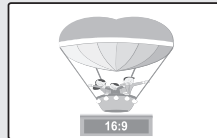

## 4:3

Sets the picture to 4:3 normal mode.



## Just Scan

Use this function to see the full image without any cutoff when DTV or HDMI 720p/1080i signals are input.

- In TV, VIDEO, S-VIDEO, and COMPONENT(480i, 480p) modes, all screen modes can be selected. (16:9 → Zoom1 → Zoom2 → 4:3)
- In COMPONENT(720p, 1080i) or HDMI(720p, 1080i) mode, 16:9, 4:3 and **Wide Fit** can be selected.
- In Zoom1, Zoom2 and Wide Fit modes, you can move the picture on the screen by pressing the **▲** or **▼** button.
- You can not change the picture size when PIP is set to Double.
- When Double (, ) mode has been set in PIP, the Picture Size cannot be set.
- Wide Fit can be used when watching a Digital HD (High Definition) signal. Wide Fit sets the optimum picture format by expanding it both horizontally and vertically. For example, you can reset the picture in 4:3 format to 16:9. Wide Fit does not support all external devices (DVD, VCR etc.).

# Making Detailed Picture Settings

You can set detailed picture settings.

- 1 Press the **MENU** button to display the menu.  
Press the **▲** or **▼** button to select **Picture**, then press the **ENTER** button.
  - 2 Press the **▲** or **▼** button to select **Detailed Settings**, then press the **ENTER** button.
  - 3 Select the desired Detailed Settings option by pressing the **▲** or **▼** button, then press the **ENTER** button.
  - 4 When you are satisfied with your setting, press the **ENTER** button.  
Press the **EXIT** button to exit.
- When the picture mode is set to **Dynamic**, **Detailed Settings** cannot be selected.

## **Black Adjust: Off/Low/Medium/High**

You can directly select the black level on the screen to adjust the screen depth.

## **Dynamic Contrast: Off/Low/Medium/High**

You can adjust the screen contrast so that the optimal contrast is provided.

## **Gamma: -3 ~ 3**

You can adjust the middle brightness of pictures.

Press the **◀** or **▶** button until you reach the optimal setting.

## **Color Space: Auto/Wide**

Color space is a color matrix composed of red, green, and blue colors. Select your favorite color space and experience the most natural color.

You can set the color reproduction space for the input signal to **Auto** or **Wide**.

## **White Balance: R-Offset/G-Offset/B-Offset/R-Gain/G-Gain/B-Gain/Reset**

You can adjust the color temperature for more natural picture colors.

**R-Offset/G-Offset/B-Offset/R-Gain/G-Gain/B-Gain:** Changing the adjustment value will refresh the adjusted screen. Select the desired option by pressing the **▲** or **▼** button, then press the **ENTER** button. Press the **◀** or **▶** button until you reach the optimal setting.

**Reset:** The previously adjusted white balance will be reset to the factory defaults.

## **My Color Control: Pink/Green/Blue/White/Reset**

This setting can be adjusted to suit your personal preferences.

**Pink/Green/Blue/White:** Select the desired color by pressing the **▲** or **▼** button, then press the **ENTER** button. Press the **◀** or **▶** button until you reach the optimal setting.

➤ When using the My Color Control Feature, the current picture remains in movement.

**Reset:** The previously adjusted colors will be reset to the factory defaults.

## **Edge Enhancement: Off/On**

You can emphasize object boundaries.

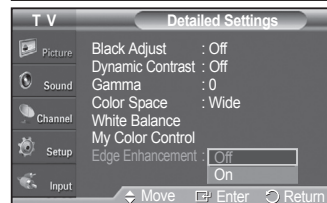
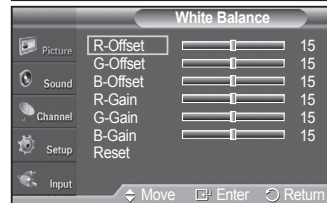
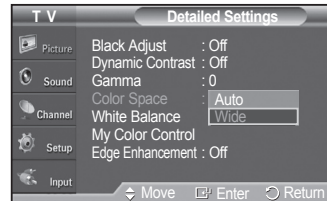
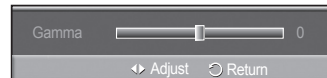
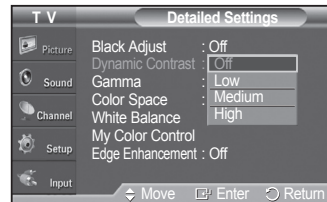
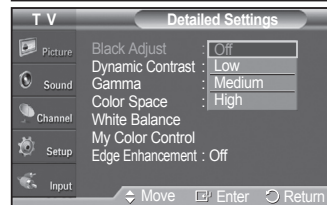
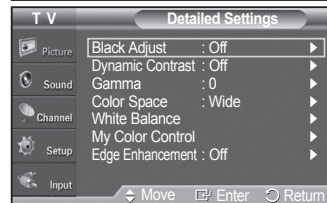
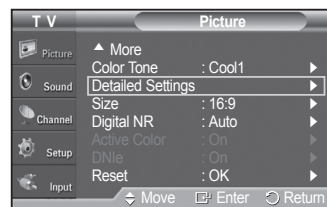

## Active Color

If you turn on this option, the colors of the sky and grass will be stronger and clearer for a more vivid on-screen picture.

- 1 Press the **MENU** button to display the menu.  
Press the **▲** or **▼** button to select **Picture**, then press the **ENTER** button.
  - 2 Press the **▲** or **▼** button to select **Active Color**, then press the **ENTER** button.
  - 3 Press the **▲** or **▼** button to select **Off** or **On**, then press the **ENTER** button.  
Press the **EXIT** button to exit.
- This function is not available in PC mode.
- When you select Standard or Movie in Picture Mode, the Active Color automatically changes to Off and it is deactivated.  
When the Picture Mode is set to Dynamic, the Active Color is activated regardless of the Picture Mode settings.

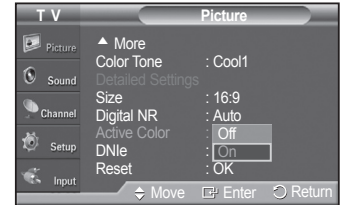
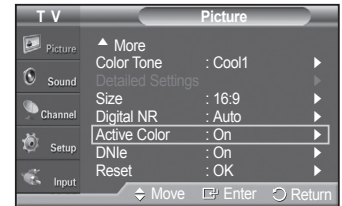

## DNle (Digital Natural Image engine)

This TV includes the DNle function to provide high visual quality. If you set DNle to on, you can view the screen with the DNle feature activated. If you set the DNle to Demo, you can view the applied DNle and normal pictures on the screen, for demonstration purposes. Using this function, you can view the difference in the visual quality.

- 1 Press the **MENU** button to display the menu.  
Press the **▲** or **▼** button to select **Picture**, then press the **ENTER** button.
- 2 Press the **▲** or **▼** button to select **DNle**, then press the **ENTER** button.  
➤ This function doesn't work when the Input Source is PC.
- 3 Press the **▲** or **▼** button to select **Off**, **DNle** or **On**, then press the **ENTER** button.

Press the **EXIT** button to exit.

- **Off**: Switches off the DNle mode.
- **DNle**: The screen before applying DNle appears on the left and the screen after applying DNle appears on the right.
- **On**: Switches on the DNle mode.

- The DNle function is not supported in the Standard and Movie mode.  
(It is inactivated.)

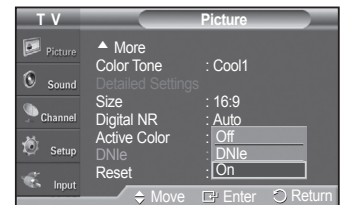
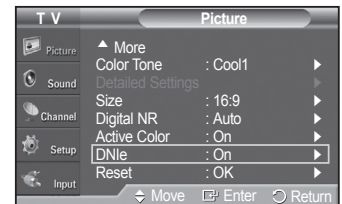

## Selecting the Film Mode

Automatically senses and processes film signals from all sources and adjusts the picture for optimum quality.

- 1 Press the **MENU** button to display the menu.  
Press the **▲** or **▼** button to select **Setup**, then press the **ENTER** button.
- 2 Press the **▲** or **▼** button to select **Film Mode**, then press the **ENTER** button.
- 3 Press the **▲** or **▼** button to select **Off** or **On**, then press the **ENTER** button.  
Press the **EXIT** button to exit.

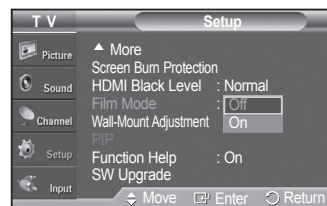
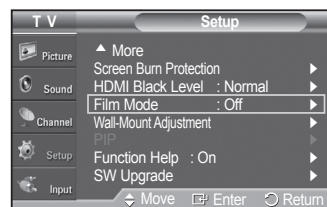

## Setting the Blue Screen Mode

If no signal is being received or the signal is very weak, a blue screen automatically replaces the noisy picture background. If you wish to continue viewing the poor picture, you must set the “Blue Screen” mode to “Off”.

- 1 Press the **MENU** button to display the menu.  
Press the **▲** or **▼** button to select **Setup**, then press the **ENTER** button.
- 2 Press the **▲** or **▼** button to select **Blue Screen**, then press the **ENTER** button.
- 3 Press the **▲** or **▼** button to select **Off** or **On**, then press the **ENTER** button.  
Press the **EXIT** button to exit.
  - Blue Screen is displayed when there is no signal from an external device, regardless of the Blue Screen Setting.

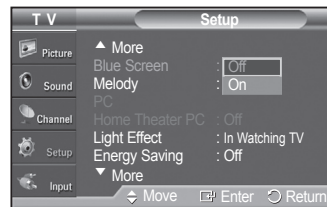
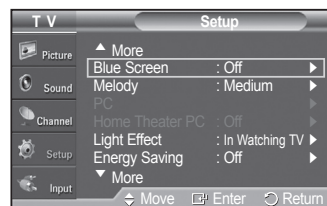

## Setting the HDMI Black Level

Use this function to adjust the Black Level of the picture while in HDMI mode.

- 1 Press the **MENU** button to display the menu.  
Press the **▲** or **▼** button to select **Setup**, then press the **ENTER** button.
- 2 Press the **▲** or **▼** button to select **HDMI Black Level**, then press the **ENTER** button.
- 3 Press the **▲** or **▼** button to select **Normal** or **Low**, then press the **ENTER** button.  
Press the **EXIT** button to exit.
  - This function is active only when the external input connects to HDMI(RGB signals).

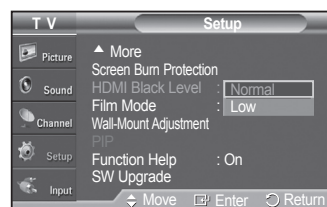
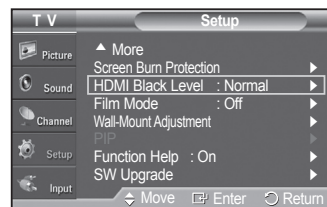

## Viewing Picture-in-Picture

This product has one built-in tuner, which does not allow PIP to function in the same mode. For example, you cannot watch one TV channel in the main screen, and a different one in the PIP screen. Please see 'PIP Settings' below for details. You can use the PIP feature to simultaneously watch two video sources. (See page 37 to select the PIP picture sound.)

➤ While V-Chip is in operation, the PIP function cannot be used. (Refer to page 56)

### Activating Picture-in-Picture

- 1 Press the **MENU** button to display the menu.  
Press the **▲** or **▼** button to select **Setup**, then press the **ENTER** button.  
Press the **▲** or **▼** button to select **PIP**, then press the **ENTER** button.



- 2 Press the **ENTER** button again.  
Press the **▲** or **▼** button to select **On**, then press the **ENTER** button.
  - If you turn the TV off while watching in PIP mode and turn it on again, the PIP window will disappear.

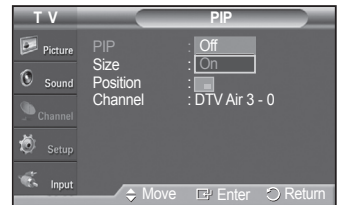

 Press the **PIP** button on the remote control to activate or deactivate the PIP.

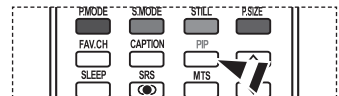

➤ Analog TV signals can be viewed on the PIP screen while viewing the picture from an external source (DVD, Set-top box, PC etc.) connected to the Component 1, 2, PC and HDMI 1, 2, 3 jacks on the main screen.

### Changing the Size of the PIP Window



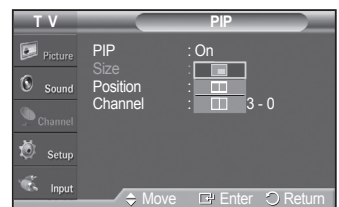

- 3 Press the **▲** or **▼** button to select **Size**, then press the **ENTER** button.  
Press the **▲** or **▼** button to select the desired size of the PIP window, then press the **ENTER** button.
  - If main picture is in PC and HDMI 1 modes, Size is not available.
  - You may notice that the picture in the PIP window becomes slightly unnatural when you use the main picture to view a game or karaoke.



*Continued...*



## Changing the Position of the PIP Window

- 4 Press the ▲ or ▼ button to select **Position**, then press the **ENTER** button. Press the ▲ or ▼ button to select the desired PIP window position, then press the **ENTER** button.
  - In Double Window (  ) and Double Wide (  ) modes, Position cannot be selected.
  - If the PIP window is set to Double Window (  ) or Double Wide (  ) mode, the screen size or alignment may slightly differ depending on the signal type.

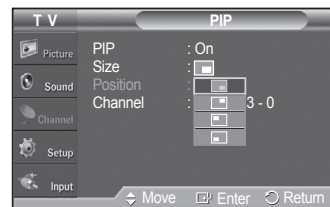

## Changing the PIP Channel

- 5 Press the ▲ or ▼ button to select **Channel**, then press the **ENTER** button. Press the ▲ or ▼ button at the bottom of the remote to select the desired channel in the PIP window, then press the **ENTER** button.
    - The channel can be active when the sub picture is set to TV.
- Press the **EXIT** button to exit.
-  Press the **PIP CH ▲** and **CH ▼** and buttons on the remote control to change the PIP channel.

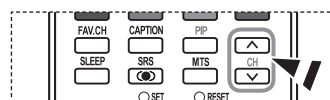
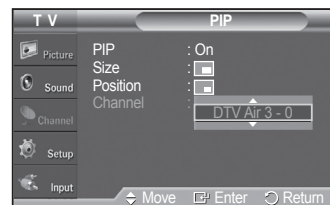

## Freezing the Current Picture

- 1 Press the **STILL** button to freeze a moving picture.
  - Normal sound will still be heard. Press again to cancel.
  - To prevent screen burn-in, this function will automatically cancel after 5 minutes.

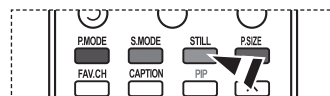

# Sound Control

## Using Automatic Sound Settings

Your TV has automatic sound settings (“Standard”, “Music”, “Movie”, “Speech”, and “Custom”) that are preset at the factory. Or, you can select “Custom”, which automatically recalls your personalized sound settings.

- 1 Press the **MENU** button to display the menu.  
Press the **▲** or **▼** button to select **Sound**, then press the **ENTER** button.
- 2 Press the **ENTER** button to select **Mode**. Press the **▲** or **▼** button to select **Standard**, **Music**, **Movie**, **Speech**, or **Custom** sound setting, then press the **ENTER** button.

Press the **EXIT** button to exit.

- Choose **Standard** for the standard factory settings.
- Choose **Music** when watching music videos or concerts.
- Choose **Movie** when watching movies.
- Choose **Speech** when watching a show that is mostly dialog (i.e., news).
- Choose **Custom** to recall your personalized settings (see Customizing the Sound).

-  Press the **S.MODE** button on the remote control to select one of the standard sound settings.

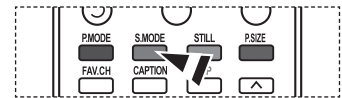
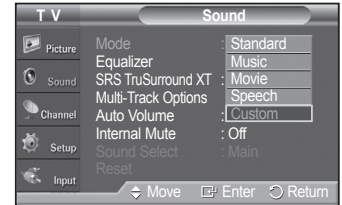

## Customizing the Sound

The sound settings can be adjusted to suit your personal preference. (Alternatively, you can use one of the “automatic” settings.)

- 1 Press the **MENU** button to display the menu.  
Press the **▲** or **▼** button to select **Sound**, then press the **ENTER** button.
- 2 Press the **▲** or **▼** button to select **Equalizer**, then press the **ENTER** button.
- 3 Press the **◀** or **▶** button to select a particular frequency to adjust.  
Press the **▲** or **▼** button to increase or decrease the level of the particular frequency, then press the **ENTER** button.

Press the **EXIT** button to exit.

- **R/L Sound Balance Adjustment:** To adjust the sound balance of the R/L speakers.
- **Frequency Adjustment (100Hz, 300Hz, 1KHz, 3KHz, 10KHz):** To adjust the level of different frequencies.
- If you make any changes to the equalizer settings, the sound mode is automatically switched to the **Custom** mode.

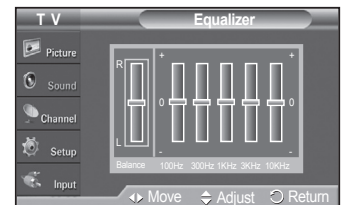
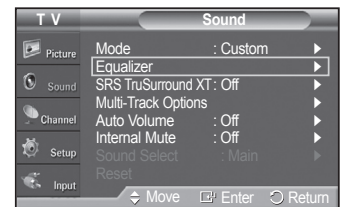

### Resetting the Equalizer Settings to the Factory Defaults

To operate the Reset function, the Game mode must be set to On. (Refer to page 49)

- 1 Press the **MENU** button to display the menu.  
Press the **▲** or **▼** button to select **Sound**, then press the **ENTER** button.
- 2 Press the **▲** or **▼** button to select **Reset**, then press the **ENTER** button.
  - The equalizer resets to the factory defaults.

Press the **EXIT** button to exit.

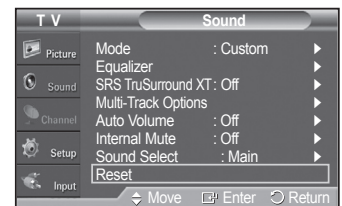

## Setting the TruSurround XT

TruSurround XT is a patented SRS technology that solves the problem of playing 5.1 multichannel content over two speakers. TruSurround delivers a compelling, virtual surround sound experience through any two-speaker playback system, including internal television speakers. It is fully compatible with all multi channel formats.

- 1 Press the **MENU** button to display the menu.  
Press the **▲** or **▼** button to select **Sound**, then press the **ENTER** button.
  - 2 Press the **▲** or **▼** button to select **SRS TruSurround XT**, then press the **ENTER** button.
  - 3 Press the **▲** or **▼** button to select **Off** or **On**, then press the **ENTER** button.  
Press the **EXIT** button to exit.
-  Press the **SRS** button on the remote control to select **On** or **Off**.

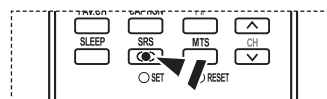
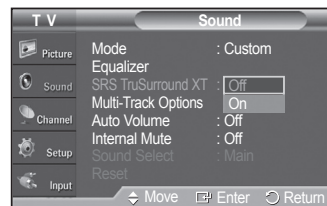

### TRADEMARK & LABEL LICENSE NOTICE



TruSurround XT, SRS and  Symbol are trademarks of SRS Labs, Inc.  
TruSurround XT technology is incorporated under license from SRS Labs, Inc.

## Choosing a Multi-Channel Sound (MTS) Track - Digital

The digital-TV broadcast system is capable of simultaneous transmission of many audio tracks (for example, simultaneous translations of the program into foreign languages). The availability of these additional "multitracks" depends upon the program.

### Preferred language

- 1 Press the **MENU** button to display the menu.  
Press the **▲** or **▼** button to select **Sound**, then press the **ENTER** button.
  - 2 Press the **▲** or **▼** button to select **Multi-Track Options**, then press the **ENTER** button.
  - 3 Press the **ENTER** button to select **Preferred Language**.  
Press the **▲** or **▼** button to choose the language (**English**, **Spanish**, or **French**) you want, then press the **ENTER** button.  
Press the **EXIT** button to exit.  
➤ You can only select the language from among the actual languages being broadcast.
-  Press the **MTS** button on the remote control to listen in a language other than the preferred language.

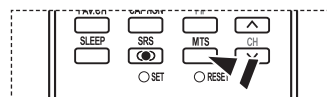
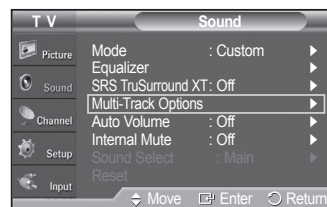

## Choosing a Multi-Channel Sound (MTS) Track - Analog

Depending on the particular program being broadcast, you can listen to Mono, Stereo or SAP.

### Multi-Track Sound

- 1 Press the **MENU** button to display the menu.  
Press the **▲** or **▼** button to select **Sound**, then press the **ENTER** button.
- 2 Press the **▲** or **▼** button to select **Multi-Track Options**, then press the **ENTER** button.
- 3 Press the **▲** or **▼** button to select **Multi-Track Sound**, then press the **ENTER** button.  
Press the **▲** or **▼** button to select a setting you want, then press the **ENTER** button.  
Press the **EXIT** button to exit.

- Choose **Mono** for channels that are broadcasting in mono, or if you are having difficulty receiving a stereo signal.
- Choose **Stereo** for channels that are broadcasting in stereo.
- Choose **SAP** to listen to the Separate Audio Program, which is usually a foreign-language translation.

 Press the **MTS** buttons on the remote control to select **Mono**, **Stereo**, or **SAP**.

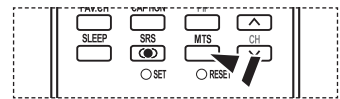
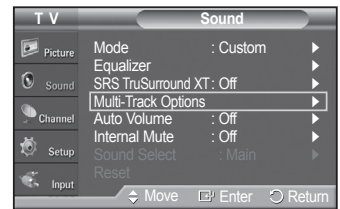

## Automatic Volume Control

Reduces the difference in volume level among broadcasters.

- 1 Press the **MENU** button to display the menu.  
Press the **▲** or **▼** button to select **Sound**, then press the **ENTER** button.
- 2 Press the **▲** or **▼** button to select **Auto Volume**, then press the **ENTER** button.
- 3 Press the **▲** or **▼** button to select **Off** or **On**, then press the **ENTER** button.  
Press the **EXIT** button to exit.

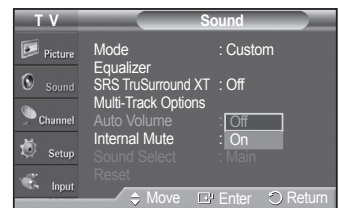
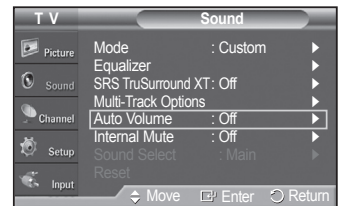

## Selecting the Internal Mute

Sound output from the TV speakers is muted. This is useful when you want to listen to audio through your sound system instead of the TV.

- 1 Press the **MENU** button to display the menu.  
Press the **▲** or **▼** button to select **Sound**, then press the **ENTER** button.
- 2 Press the **▲** or **▼** button to select **Internal Mute**, then press the **ENTER** button.

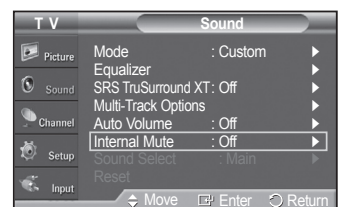

*Continued...*

- Press the **▲** or **▼** button to select **Off** or **On**, then press the **ENTER** button.

Press the **EXIT** button to exit.

- When Internal Mute is set to On, Sound menus except Multi-track Options cannot be adjusted.
- The left/right audio outputs and digital audio outputs (Optical) remain enabled.
- The **VOL +**, **VOL -** and **MUTE** buttons do not operate when the Internal Mute is set to On.

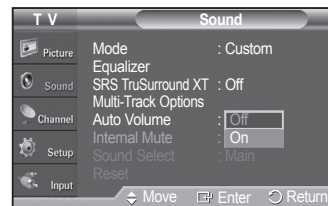

	TV's Internal Speakers			Audio Out Optical (R/L Out) to Sound System		
	TV	AV, S-Video	Component, PC, HDMI	TV	AV, S-Video	Component, PC, HDMI
<b>Internal Mute Off</b>	Speaker Output	Speaker Output	Speaker Output	Sound Output	Sound Output	Sound Output
<b>Internal Mute On</b>	Mute	Mute	Mute	Sound Output	Sound Output	Sound Output
<b>Video No Signal</b>	Mute	Mute	Mute	Mute	Mute	Mute

When Internal Mute is set to On, Sound menus except Multi-Track Options cannot be adjusted.

## Adjusting the Melody Sound

The TV power on/off melody sound volume can be adjusted.

- Press the **MENU** button to display the menu. Press the **▲** or **▼** button to select **Setup**, then press the **ENTER** button.
- Press the **▲** or **▼** button to select **Melody**, then press the **ENTER** button.
- Press the **▲** or **▼** button to select **Off**, **Low**, **Medium**, or **High**, then press the **ENTER** button. Press the **EXIT** button to exit.

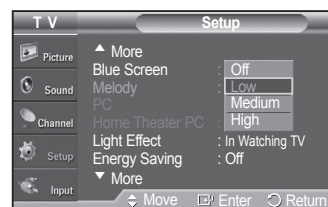
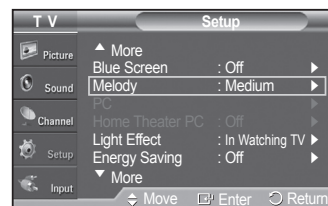

### TRADEMARK & LABEL LICENSE NOTICE

**DOLBY** Manufactured under license from Dolby Laboratories. Dolby and the double-D DIGITAL symbol are trademarks of Dolby Laboratories.

## Listening to the Sound of the Sub (PIP) Picture

When the PIP feature is activated, you can listen to the sound of the sub (PIP) picture.

- Press the **MENU** button to display the menu. Press the **▲** or **▼** button to select **Sound**, then press the **ENTER** button.
- Press the **▲** or **▼** button to select **Sound Select**, then press the **ENTER** button.
- Press the **▲** or **▼** button to select **Sub**, then press the **ENTER** button. Press the **EXIT** button to exit.

- Main**: Used to listen to the sound of the main picture.
- Sub**: Used to listen to the sound of the sub picture.

- You can select this option when PIP is set to On.

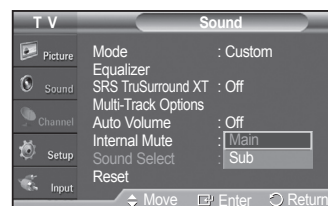
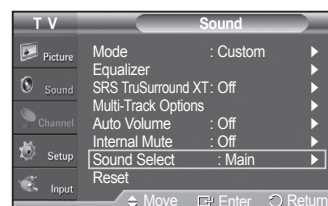

# Channel Control

## Selecting the Antenna

- 1 Press the **MENU** button to display the menu.  
Press the **▲** or **▼** button to select **Channel**, then press the **ENTER** button.
  - 2 Press the **ENTER** button to select **Antenna**.  
Press the **▲** or **▼** button to select **Air** or **Cable**, then press the **ENTER** button.  
Press the **EXIT** button to exit.
-  Press the **ANTENNA** button on the remote control to select **Air** or **Cable**.

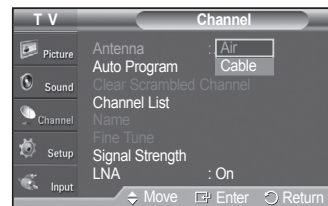

➤ If the antenna is connected to ANT1 IN(AIR), select **Air** and if it is connected to ANT2 IN(CABLE), select **Cable**.



➤ If both ANT1 IN(AIR) and ANT2 IN(CABLE) are connected, select the antenna input you want. If the antenna input is not selected properly, noise may appear on the screen.

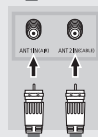

## Adding and Erasing Channels

You can add or delete a channel to display the channels you want. To use the Channel List function, first run Auto Program (see page 19).

- 1 Press the **MENU** button to display the menu.  
Press the **▲** or **▼** button to select **Channel**, then press the **ENTER** button.
- 2 Press the **▲** or **▼** button to select **Channel List**, then press the **ENTER** button.
- 3 Press the **▲** or **▼** button to select **Added**, then press the **ENTER** button.
- 4 Press the **▲/▼/◀/▶** buttons to select a channel to add, then press the **ENTER** button.  
Press the **▲** or **▼** button to select **Add**, then press the **ENTER** button to add the channel.  
Press the **MENU** button to return.  
➤ All added channels will be shown on **Added** menu.

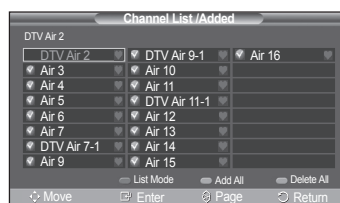

*Continued...*

- Press the ▲/▼/◀/▶ buttons to select a channel to delete, then press the **ENTER** button.  
Press the ▲ or ▼ button to select **Delete**, then press the **ENTER** button to delete the channel.

Press the **EXIT** button to exit.

- **Red (P.MODE) button:** Press repeatedly to select **All**, **Added**, or **Favorite**.
- **Green (S.MODE) button:** Press to add all channels deleted.
- **Yellow (STILL) button:** Press to delete all channels memorized.



## Setting Your Favorite Channels

You can set channels you watch frequently as favorites.

- Press the **MENU** button to display the menu.  
Press the ▲ or ▼ button to select **Channel**, then press the **ENTER** button.
- Press the ▲ or ▼ button to select **Channel List**, then press the **ENTER** button.
- Press the ▲ or ▼ button to select **All** or **Added**, then press the **ENTER** button.
- Press the ▲/▼/◀/▶ buttons to select a channel as a favorite channel, then press the **ENTER** button.  
Press the **CH** ^ and **CH** v button to display the next channel list page.



- Press the ▲ or ▼ button to select **Favorite**, then press the **ENTER** button.  
The “♥” symbol will be highlighted and the channel will be set as a Favorite.  
To cancel your Favorite channel selection, press the **ENTER** button until the “♥” symbol disappears.

Press the **EXIT** button to exit.

- Only memorized channels can be set as favorite channels.
- All favorite channels will be shown on the **Favorite** menu.

To select the favorite channels you have set up, press the **FAV.CH** button on the remote control.

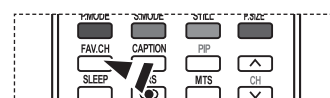
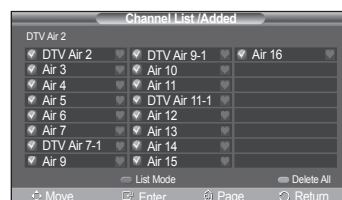

## Viewing the Channel Lists

You can display a list of all channels, added channels or your favorite channels.

- 1 Press the **MENU** button to display the menu.  
Press the **▲** or **▼** button to select **Channel**, then press the **ENTER** button.
- 2 Press the **▲** or **▼** button to select **Channel List**, then press the **ENTER** button.
- 3 Press the **▲** or **▼** button to select **All**, **Added** or **Favorite**, then press the **ENTER** button.

To toggle between your all channels, added channels, or favorite channels, use the red (P.MODE) button on the remote control.

- **Red (P.MODE) button:** Press repeatedly to select **All**, **Added**, or **Favorite**.
- **Yellow (STILL) button:** Press to delete all channels memorized.

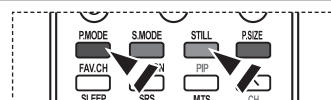
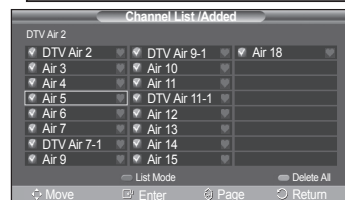
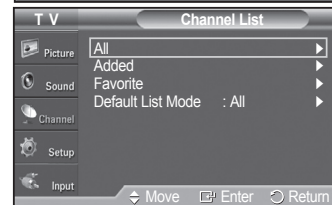

## Setting the Default Channel List Mode

You can set All, Added, or Favorite to be the Default List that appears when you press the CH LIST button.

- 1 Press the **MENU** button to display the menu.  
Press the **▲** or **▼** button to select **Channel**, then press the **ENTER** button.
- 2 Press the **▲** or **▼** button to select **Channel List**, then press the **ENTER** button.
- 3 Press the **▲** or **▼** button to select **Default List Mode**, then press the **ENTER** button.  
Press the **▲** or **▼** button to select **All**, **Added**, or **Favorite**, then press the **ENTER** button.
  - Select the Channel list you want to appear when you press the **CH LIST** button.

- **All:** Shows All the channels when you press the **CH LIST** button on the remote control.
- **Added:** Shows Added channels when you press **CH LIST** button on the remote control.
- **Favorite:** Shows Favorite channels when you press **CH LIST** button on the remote control.

Press the **EXIT** button to exit.

-  Press the **CH LIST** button on the remote control to bring up the Channel Lists.

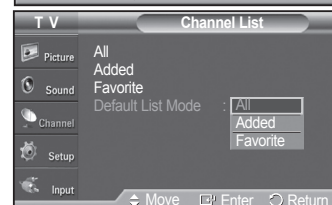



## Labeling Channels

Channels can be labeled so that their call letters appear whenever the channel is selected.

- 1 Press the **MENU** button to display the menu.  
Press the **▲** or **▼** button to select **Channel**, then press the **ENTER** button.  
Press the **▲** or **▼** button to select **Name**, then press the **ENTER** button.
- 2 Press the **▲** or **▼** button to select the channel to be assigned a new name, then press the **ENTER** button.
- 3 Press the **▲** or **▼** button to select a letter, a number or a blank (Results in this sequence: A~Z, 0~9, +, -, \*, /, blank).  
Press the **▶** button to switch to the next field, which will be selected.  
Select a second letter or digit by pressing the **▲** or **▼** button, as above.  
Repeat the process to select the last three digits. When you have finished, press the **ENTER** button to assign the new name.  
To erase the assigned new name, select **Clear** by pressing the **◀** or **▶** button, then press the **ENTER** button.

Press the **EXIT** button to exit.

- The names of digital broadcasting channels are automatically assigned and thus cannot be assigned by users.



## Fine Tuning Analog Channels

Use fine tuning to manually adjust a particular channel for optimal reception.

- 1 Press the **MENU** button to display the menu.  
Press the **▲** or **▼** button to select **Channel**, then press the **ENTER** button.
- 2 Press the **▲** or **▼** button to select **Fine Tune**, then press the **ENTER** button.
- 3 Press the **◀** or **▶** button to adjust the fine tuning.
- 4 To store the fine tuning setting in the TV's memory, press the **ENTER** button.  
To reset the fine tuning setting, press the **▼** button to select **Reset**, then press the **ENTER** button.

Press the **EXIT** button to exit.

- Only analog TV channels can be fine tuned.
- “ \* ” will appear next to the number of fine-tuned channels.

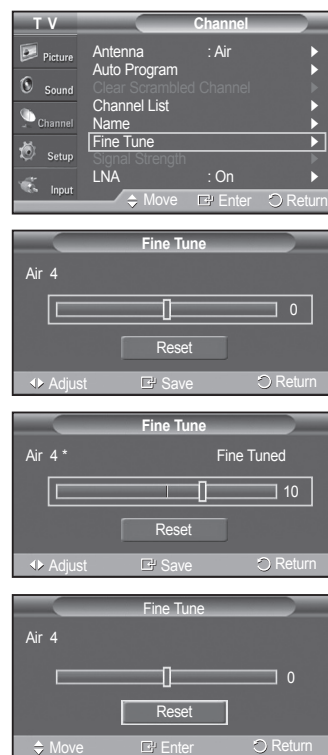

## Checking the Digital-Signal Strength

Unlike analog channels, which can vary in reception quality from “snowy” to clear, digital (HDTV) channels have either perfect reception quality or you will not receive them at all. So, unlike analog channels, you cannot fine tune a digital channel. You can, however, adjust your antenna to improve the reception of available digital channels.

- 1 Press the **MENU** button to display the menu.  
Press the **▲** or **▼** button to select **Channel**, then press the **ENTER** button.
- 2 Press the **▲** or **▼** button to select **Signal Strength**, then press the **ENTER** button. If the signal strength meter indicates that the signal is weak, physically adjust your antenna to increase the signal strength.  
Continue to adjust the antenna until you find the best position with the strongest signal.

Press the **EXIT** button to exit.

You can also press the **ENTER** button to select **OK** then press the **EXIT** button to exit the menu.

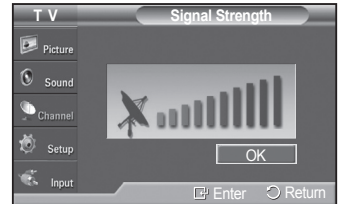

## LNA (Low Noise Amplifier)

If the TV is operating in a weak-signal area, sometimes the LNA function can improve the reception (a low-noise preamplifier boosts the incoming signal).

- 1 Press the **MENU** button to display the menu.  
Press the **▲** or **▼** button to select **Channel**, then press the **ENTER** button.
- 2 Press the **▲** or **▼** button to select **LNA**, then press the **ENTER** button.
- 3 Press the **▲** or **▼** button to select **Off** or **On**, then press the **ENTER** button.

Press the **EXIT** button to exit.

- LNA functions only when antenna is set to Air.  
(See “Selecting the Antenna” on page 38)
- If the picture is noisy with the LNA set to **On**, select **Off**.
- The LNA setting must be made separately for each channel.



# PC Display

## Using Your TV as a Computer (PC) Display

### Setting Up Your PC Software (Based on Windows XP)

The Windows display-settings for a typical computer are shown below. The actual screens on your PC will probably be different, depending upon your particular version of Windows and your particular video card. However, even if your actual screens look different, the same basic set-up information will apply in almost all cases. (If not, contact your computer or Video Card manufacturer.)

- 1 First, click on **Control Panel** on the Windows start menu.
- 2 When the control panel window appears, click on **Appearance and Themes** and a display dialog-box will appear.
- 3 When the control panel window appears, click on **Display** and a display dialog-box will appear.
- 4 Navigate to the **Settings** tab on the display dialog-box.

The correct size setting (resolution)  
Optimum: 1024 x 768 pixels

If a vertical-frequency option exists on your display settings dialog box, the correct value is **60** or **60 Hz**. Otherwise, just click **OK** and exit the dialog box.

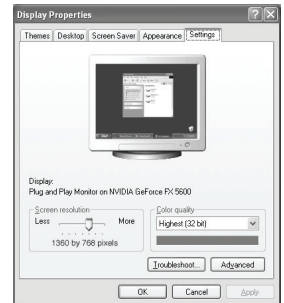

## Display Modes

If the signal from the system equals the standard signal mode, the screen is adjusted automatically. If the signal from the system doesn't equal the standard signal mode, adjust the mode by referring to your videocard user guide; otherwise there may be no video. For the display modes listed below, the screen image has been optimized during manufacture.

### D-Sub Input

Resolution	Vertical Frequency (Hz)	Horizontal Frequency (kHz)	Vertical Polarity	Horizontal Polarity	HP-T4264	HP-T5064	
VGA	720 x 400	70.087	31.469	N	P	✓	✓
		59.940	31.469	N	N	✓	✓
	640 x 480	72.809	37.861	N	N	✓	✓
		75.000	37.500	N	N	✓	✓
SVGA	800 x 600	60.317	37.879	P	P	✓	✓
		72.188	48.077	P	P	✓	✓
		75.000	46.875	P	P	✓	✓
XGA	1024 x 768	60.004	48.363	N	N	✓	✓
		70.069	56.476	N	N	✓	✓
		75.029	60.023	P	P	✓	✓
WXGA	1360 x 768	60.015	47.712	P	P	✓	✓

### HDMI/DVI Input

Resolution	Vertical Frequency (Hz)	Horizontal Frequency (kHz)	Vertical Polarity	Horizontal Polarity	HP-T4264	HP-T5064	
VGA	720 x 400	70.087	31.469	N	P	✓	✓
	640 x 480	59.940	31.469	N	N	✓	✓
SVGA	800 x 600	60.317	37.879	P	P	✓	✓
XGA	1024 x 768	60.004	48.363	N	N	✓	✓
WXGA	1360 x 768	60.015	47.712	P	P	✓	✓

- The interlace mode is not supported.
- The TV operates abnormally if a non-standard video format is selected.
- The table above conforms to IBM/VESA regulations and is based on using the Analog Input.
- “✓” mark means that this mode can be supported.
- • For the HP-T4264, PC text quality is optimum in XGA mode (1024 x 768@60Hz).
- For the HP-T5064, PC text quality is optimum in WXGA mode (1360 x 768@60Hz). (Three pixels on left, right, top and bottom will be grayed out at the resolution setting of 1360x768@60Hz. This is not a mechanical problem but a result caused by the pixel difference between the standard resolution and the PDP panel.)
- When this TV is used as a PC display, 32-bit color is supported.
- Depending on the manufacturer, your PC display screen might appear different. (and depending on your particular version of Windows.) Check your PC instruction book for information about connecting your PC to a TV.
- If a vertical and horizontal frequency-select mode exists, select 60Hz (vertical) and 48.4KHz (horizontal).
- In some cases, abnormal signals (such as stripes) might appear on the TV screen when the PC power is turned off (or if the PC is disconnected). If so, press the **SOURCE** button on the remote control or TV panel to enter a VIDEO mode. Also, make sure that the PC is connected.

## Setting up the TV with your PC

Use the Auto Adjust function to have the TV set automatically adjust the video signals it receives from the PC. The function also automatically fine-tunes the settings and adjusts the frequency values and positions.

### How to Auto Adjust

- 1 Press the **MENU** button to display the menu.  
Press the **▲** or **▼** button to select **Setup**, then press the **ENTER** button.  
Press the **▲** or **▼** button to select **PC**, then press the **ENTER** button.
- 2 Press the **▲** or **▼** button to select **Auto Adjustment**, then press the **ENTER** button. The message **Auto Adjustment in progress. Please wait.** appears on the screen and the picture adjustments are automatically activated.

Press the **EXIT** button to exit.

- This function does not work in DVI-Digital mode.
- Change to the PC mode first.

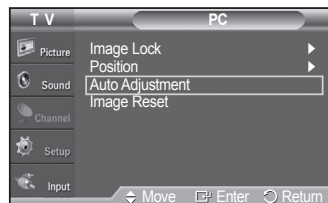
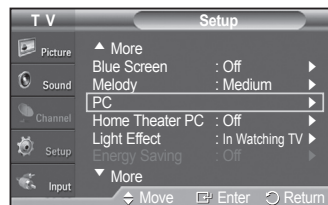

Auto Adjustment in progress. Please wait.

### Adjusting the Screen Quality

The purpose of the picture quality adjustment is to remove or reduce picture noise. If the noise is not removed by fine tuning alone, then do the frequency adjustments to the utmost and fine tune again. After the noise has been reduced, re-adjust the picture so that it is aligned on the center of the screen.

- Change to the PC mode first.

- 1 Press the **MENU** button to display the menu.  
Press the **▲** or **▼** button to select **Setup**, then press the **ENTER** button.  
Press the **▲** or **▼** button to select **PC**, then press the **ENTER** button.
- 2 Press the **ENTER** button to select **Image Lock**.
- 3 Press the **▲** or **▼** button to select **Coarse** or **Fine**, then press the **ENTER** button.  
Press the **◀** or **▶** button to adjust the screen quality, then press the **ENTER** button.

Press the **EXIT** button to exit.

- This feature may change the width of the image. If necessary, adjust the position to center.

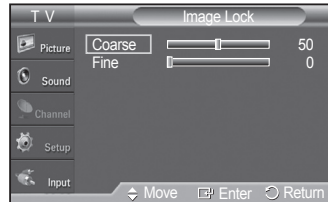

*Continued...*

## Changing the Screen Position

After connecting the TV to your PC, adjust the position of the screen if it is not well-aligned.

➤ Change to the PC mode first.

- 1 Press the **MENU** button to display the menu.  
Press the **▲** or **▼** button to select **Setup**, then press the **ENTER** button.  
Press the **▲** or **▼** button to select **PC**, then press the **ENTER** button.
- 2 Press the **▲** or **▼** button to select **Position**, then press the **ENTER** button.
- 3 Press the **▲** or **▼** button to adjust the V-Position.  
Press the **◀** or **▶** button to adjust the H-Position.  
Press the **ENTER** button.  
Press the **EXIT** button to exit.

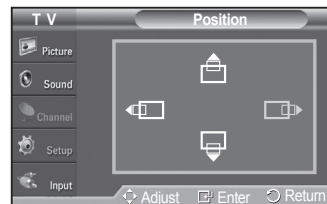
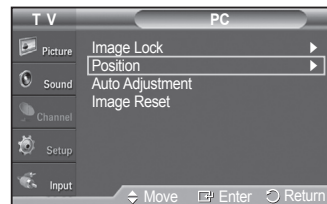

## Initializing the Screen Position

➤ Change to the PC mode first.

- 1 Press the **MENU** button to display the menu.  
Press the **▲** or **▼** button to select **Setup**, then press the **ENTER** button.  
Press the **▲** or **▼** button to select **PC**, then press the **ENTER** button.
- 2 Press the **▲** or **▼** button to select **Image Reset**, then press the **ENTER** button.  
The message **Image Reset is completed.** appears on the screen.  
Press the **EXIT** button to exit.  
➤ The previously adjusted settings will be reset to the factory defaults.

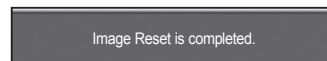
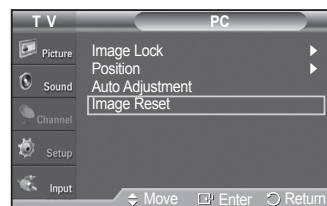

## Setting the Home Theater PC

This function enables you to view higher quality pictures while in PC Mode. After setting the Home Theater PC function to On, you can go into the Detailed Settings menu and make adjustments without affecting settings in the regular TV mode.

- 1 Press the **MENU** button to display the menu.  
Press the **▲** or **▼** button to select **Setup**, then press the **ENTER** button.  
Press the **▲** or **▼** button to select **Home Theater PC**, then press the **ENTER** button.
  - 2 Press the **▲** or **▼** button to select **Off** or **On**, then press the **ENTER** button.  
Press the **EXIT** button to exit.
- This function is available only in PC mode.

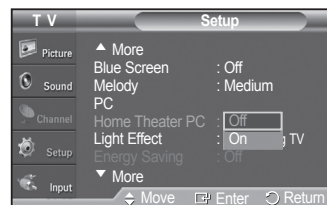
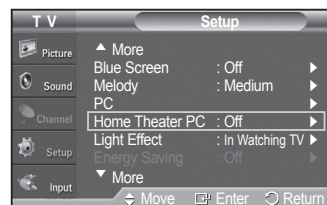

# Time Setting

## Setting the Time

Setting the clock is necessary in order to use the various timer features of the TV. Also, you can check the time while watching the TV. (Just press the INFO button.)

### Option 1: Setting the Clock Manually

- 1 Press the **MENU** button to display the menu.  
Press the **▲** or **▼** button to select **Setup**, then press the **ENTER** button.  
Press the **▲** or **▼** button to select **Time**, then press the **ENTER** button.
- 2 Press the **ENTER** button to select **Clock**.
- 3 Press the **ENTER** button to select **Clock Mode**.  
Press the **▲** or **▼** button to select **Manual**, then press the **ENTER** button.
- 4 Press the **▲** or **▼** button to select **Clock Set**, then press the **ENTER** button.
- 5 Press the **◀** or **▶** button to move to **Month**, **Day**, **Year**, **Hour**, **Minute**, or **am/pm**. Set the date and time you want by pressing the **▲** or **▼** button, then press the **ENTER** button.  
Press the **EXIT** button to exit.
  - The current time will appear every time you press the **INFO** button.
  - You can set the **Month**, **Day**, **Year**, **Hour**, and **Minute** directly by pressing the number buttons on the remote control.

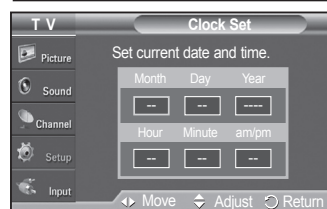

*Continued...*

## Option 2: Setting the Clock Automatically

The Clock can be set automatically if you are receiving a digital signal.

- 1 Press the **MENU** button to display the menu.  
Press the **▲** or **▼** button to select **Setup**, then press the **ENTER** button.  
Press the **▲** or **▼** button to select **Time**, then press the **ENTER** button.
- 2 Press the **ENTER** button to select **Clock**.
- 3 Press the **ENTER** button to select **Clock Mode**.  
Press the **▲** or **▼** button to select **Auto**, then press the **ENTER** button.
- 4 Press the **▲** or **▼** button to select **Time Zone**, then press the **ENTER** button.
- 5 Press the **▲** or **▼** button to highlight the time zone for your local area (and to move the highlight to the appropriate time zone on the map of the United States), then press the **ENTER** button.
- 6 Press the **▲** or **▼** button to select **DST** (Daylight Saving Time), then press the **ENTER** button.  
Press the **▲** or **▼** button to select **On** or **Off**, then press the **ENTER** button.  
Press the **EXIT** button to exit.
  - Depending on the broadcast station and signal, the auto time may not be set correctly. If this occurs, set the time manually.
  - Antenna or Cable must be connected in order to set the time automatically.

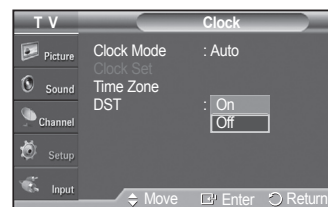
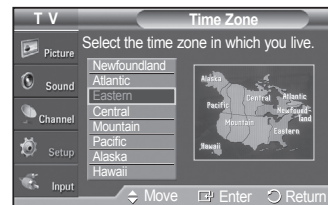
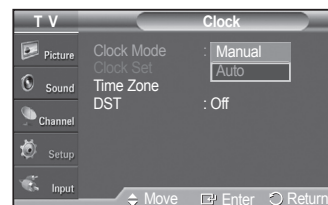

Continued...

## Setting the On/Off Timer

Use this feature to set the TV to turn on or off at a desired time. You must set the clock first.

- 1 Press the **MENU** button to display the menu.  
Press the **▲** or **▼** button to select **Setup**, then press the **ENTER** button.  
Press the **▲** or **▼** button to select **Time**, then press the **ENTER** button.
- 2 Press the **▲** or **▼** button to select **Timer1**, **Timer2**, or **Timer3**, then press the **ENTER** button. The timer menu is displayed.  
Press the **▲** or **▼** button to adjust hour, then press the **▶** button to move to the next step. Set other items using the same method as above.
- 3 Press the **◀** or **▶** button to select the desired item below.  
Press the **▲** or **▼** button to adjust the setting.

Press the **EXIT** button to exit.

- **On Time:** Select hour, minute, **am/pm**, and **Inactivated/Activated**.  
(To activate the On Time, set to **Activated**.)
- **Off Time:** Select hour, minute, **am/pm**, and **Inactivated/Activated**.  
(To activate Off time, set to **Activated**.)
- **Repeat:** Select **Once**, **Everyday**, **Mon-Fri**, **Mon-Sat**, or **Sat-Sun**.
- **Volume:** Select the volume level you want the TV to be at when it turns on with the Timer.
- **Contents:** When the On Timer is active, you can turn on a specific channel or play back contents such as photo or audio files. (Make sure that an USB device is connected to your TV.)

➤ You can set the hour, and minute directly by pressing the number buttons on the remote control.

### ➤ Auto Power Off

When you set the timer **On**, the television will eventually turn off, if no controls are operated for 3 hours after the TV was turned on by timer. This function is only available in timer **On** mode and prevents overheating, which may occur if a TV is on for too long time.

## Setting the Sleep Timer

The sleep timer automatically shuts off the TV after a preset time (30, 60, 90, 120, 150 and 180 minutes).

- 1 Press the **MENU** button to display the menu.  
Press the **▲** or **▼** button to select **Setup**, then press the **ENTER** button.  
Press the **▲** or **▼** button to select **Time**, then press the **ENTER** button.
- 2 Press the **▲** or **▼** button to select **Sleep Timer**, then press the **ENTER** button.
- 3 Press the **▲** or **▼** button to select the minute.  
Setting the Timer sets the **Activation** to **On** automatically.  
**To cancel the set sleep timer:**  
Press the **▶** button to select **Activation**.  
Press the **▲** or **▼** button to select **Off**, then press the **ENTER** button.

Press the **EXIT** button to exit.

-  Press the **SLEEP** button on the remote control until the appropriate time interval appears (any of the preset values from 30 min to 180 min).

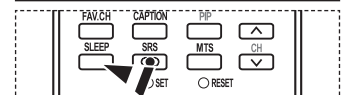
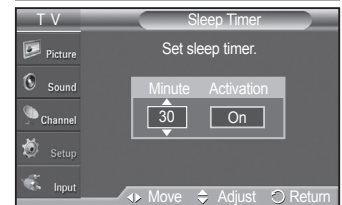
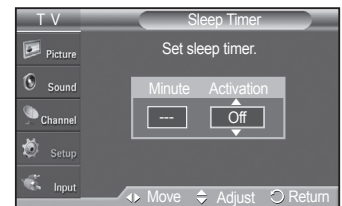
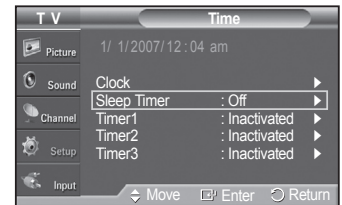
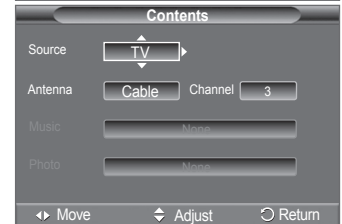
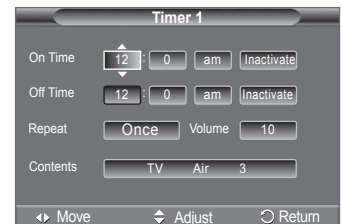
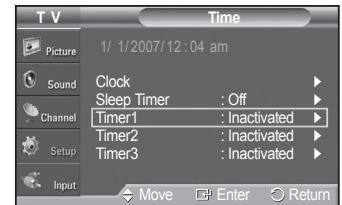



# Function Description

## Selecting a Menu Language

Setting the clock is necessary in order to use the various timer features of the TV. Also, you can check the time while watching the TV. (Just press the INFO button.)

- 1 Press the **MENU** button to display the menu.  
Press the **▲** or **▼** button to select **Setup**, then press the **ENTER** button.  
Press the **▲** or **▼** button to select **Language**, then press the **ENTER** button.
- 2 Press the **▲** or **▼** button to select the appropriate language: **English**, **Español**, or **Français**, then press the **ENTER** button.  
Press the **EXIT** button to exit.

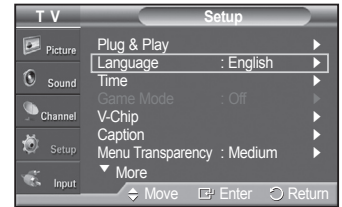

## Using the Game Mode

When connecting to a game console such as PlayStation™ or Xbox™, you can enjoy a more realistic gaming experience by selecting game menu.

- 1 Press the **MENU** button to display the menu.  
Press the **▲** or **▼** button to select **Setup**, then press the **ENTER** button.
- 2 Press the **▲** or **▼** button to select **Game Mode**, then press the **ENTER** button.
- 3 Select **Off** or **On** by pressing the **▲** or **▼** button, then press the **ENTER** button.
- 4 Press the **EXIT** button to exit.
  - **Restrictions on Game mode (Caution)**
    - To disconnect the game console and connect another external device, set Game to Off in the setup menu.
    - If you display the TV menu in Game mode, the screen shakes slightly.
    - The mark (🎮) appears on the screen which means that Game Mode is on with the selected source.
  - **If Game Mode is On**
    - Picture Mode is automatically changed to Game and cannot be changed.
    - Sound Mode in the Sound menu is deactivated. Adjust the sound using the equalizer.
    - The Reset in the Sound menu is activated. Reset function initializes the Equalizer settings to the factory default setting.
  - Game Mode is not available in regular TV/Antenna mode.
  - If the picture is poor when external device is connected to TV, check if Game Mode is On. Set Game Mode to Off and connect external devices.

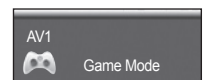
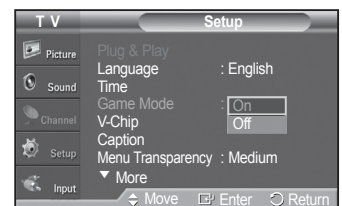

# Viewing Closed Captions (On-Screen Text Messages) - Digital

The Digital Captions function operates on digital channels.

- 1 Press the **MENU** button to display the menu.  
Press the **▲** or **▼** button to select **Setup**, then press the **ENTER** button.
- 2 Press the **▲** or **▼** button to select **Caption**, then press the **ENTER** button.
- 3 Press the **ENTER** button to select **Caption**.  
Press the **▲** or **▼** button to select **On**, then press the **ENTER** button.
- 4 Press the **▲** or **▼** button to select **Caption Mode**, then press the **ENTER** button.  
Press the **▲** or **▼** button to select submenu (**Default**, **Service1~Service6**, **CC1~CC4** or **Text1~Text4**) you want, then press the **ENTER** button.
5. Press the **▲** or **▼** button to select **Caption Options**, then press the **ENTER** button.
- 6 Press the **▲** or **▼** button to select **Size**, then press the **ENTER** button.  
Press the **▲** or **▼** button to select the desired caption option, then press the **ENTER** button.  
Press the **▲** or **▼** button to select the desired sub-menu options (see options below), then press the **ENTER** button.

Press the **EXIT** button to exit.

- The availability of captions depends on the program being broadcast.
- **Default** means to follow the standard set by the broadcaster.
- Foreground and Background cannot be set to have the same color.
- Foreground Opacity and Background Opacity cannot be both set to Transparent.

- **Size:** This option consists of **Default**, **Small**, **Standard**, and **Large**. The default is **Default**.
- **Font Style:** This option consists of **Default**, **Style0 ~ Style7**. You can change the font you want. The default is **Default**.
- **Foreground Color:** This option consists of **Default**, **White**, **Black**, **Red**, **Green**, **Blue**, **Yellow**, **Magenta**, and **Cyan**. You can change the color of the letter. The default is **Default**.
- **Background Color:** This option consists of **Default**, **White**, **Black**, **Red**, **Green**, **Blue**, **Yellow**, **Magenta**, and **Cyan**. You can change the background color of the caption. The default is **Default**.
- **Foreground Opacity:** This option consists of **Default**, **Transparent**, **Translucent**, **Solid**, and **Flashing**. You can change the opacity of the letter.
- **Background Opacity:** This option consists of **Default**, **Transparent**, **Translucent**, **Solid**, and **Flashing**. You can change the background opacity of the caption.
- **Return to Default:** This option sets each of **Size**, **Font Style**, **Foreground Color**, **Background Color**, **Foreground Opacity**, and **Background Opacity** to its default.

 Press the **CAPTION** button on the remote control to select **On** or **Off**.

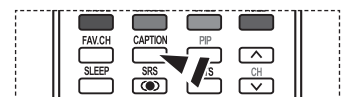
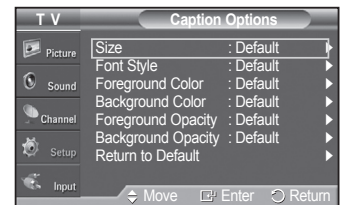
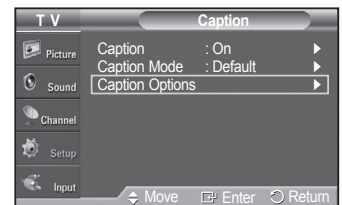
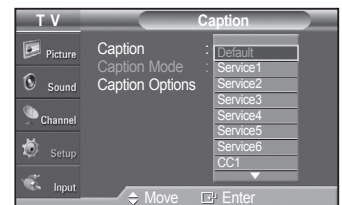
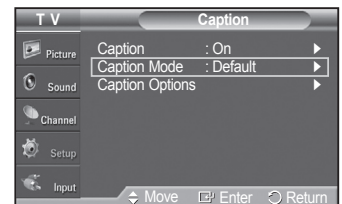
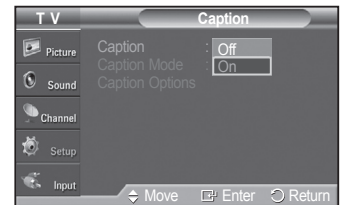

## Viewing Closed Captions (On-Screen Text Messages) - Analog

The Analog Caption function operates in either analog TV channel mode or external signal mode. (Depending on the broadcasting signal, the Analog Caption function may operate on digital channels.)

- 1 Press the **MENU** button to display the menu.  
Press the **▲** or **▼** button to select **Setup**, then press the **ENTER** button.
- 2 Press the **▲** or **▼** button to select **Caption**, then press the **ENTER** button.



- 3 Press the **ENTER** button to select **Caption**.  
Press the **▲** or **▼** button to select **On**, then press the **ENTER** button.

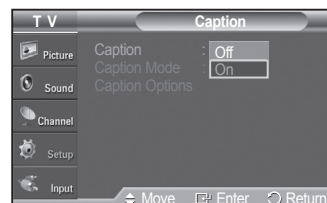

- 4 Press the **▲** or **▼** button to select **Caption Mode**, then press the **ENTER** button. Press the **▲** or **▼** button to select submenu (**CC1~CC4** or **Text1~Text4**) you want, then press the **ENTER** button.



Press the **EXIT** button to exit.

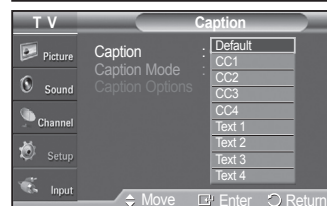

- The default is **Default**.
- **CC1**: The Primary Synchronous Caption Service. These are captions in the primary language that must be in sync with the sound, preferably matched to a specific frame.
- **CC2**: The Special Non-Synchronous Use Captions. This channel carries data that is intended to augment information carried in the program.
- **CC3**: Secondary Synchronous Caption Service.  
Alternate program-related caption data, typically second language captions.
- **CC4**: Special Non-Synchronous Use Captions. Similar to CC2.
- **Text1**: First Text Service. This may be various non-program related data.
- **Text2**: Second Text Service. Additional data, usually not program related.
- **Text3/Text4**: Third and Fourth Text Services. These data channels should be used only if Text1 and Text2 are not sufficient.

- • The Caption feature doesn't work in COMPONENT, PC, HDMI(DVI) modes.
- The availability of captions depends on the program being broadcast.

 You can also press the **CAPTION** button on the remote control to select Captions **On** or **Off**.

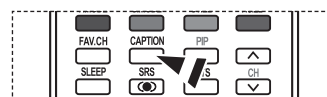

## Menu Transparency Level

Adjusts the transparency of the menu screen.

- 1 Press the **MENU** button to display the menu.  
Press the **▲** or **▼** button to select **Setup**, then press the **ENTER** button.
- 2 Press the **▲** or **▼** button to select **Menu Transparency**, then press the **ENTER** button.
- 3 Press the **▲** or **▼** button to select level, then press the **ENTER** button.  
Press the **EXIT** button to exit.



## Setting the Light Effect

You can turn the blue LED on the front of TV on/off.

- 1 Press the **MENU** button to display the menu.  
Press the **▲** or **▼** button to select **Setup**, then press the **ENTER** button.
- 2 Press the **▲** or **▼** button to select **Light Effect**, then press the **ENTER** button.  
Press the **▲** or **▼** button to select **Off**, **In Standby**, **In Watching TV**, or **Always**, then press the **ENTER** button.  
Press the **EXIT** button to exit.

- **Off**: The LED is always off.
- **In Standby**: The LED lights while in Standby mode and it turns off when your TV is turned on.
- **In Watching TV**: The LED lights when watching TV and it turns off when your TV is turned off.
- **Always**: The LED is always lit.

- Set the Light Effect to Off to reduce the power consumption.

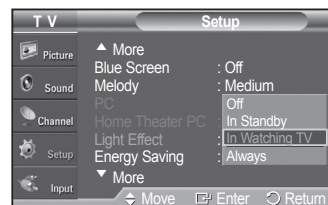
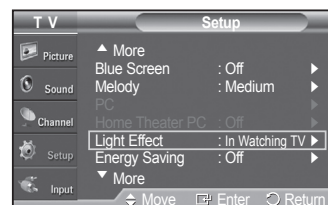

## Using the Energy Saving Feature

This feature adjusts the power consumption of the unit in order to save energy.

- 1 Press the **MENU** button to display the menu.  
Press the **▲** or **▼** button to select **Setup**, then press the **ENTER** button.
- 2 Press the **▲** or **▼** button to select **Energy Saving**, then press the **ENTER** button.  
Press the **▲** or **▼** button to select **Off**, **Low**, **Medium**, or **High**, then press the **ENTER** button.

Press the **EXIT** button to exit.

- **Off:** Switches off the Energy Saving mode.
- **Low:** Operates in standard mode.
- **Medium:** Enters medium power saving mode.
- **High:** Enters maximum power saving mode.

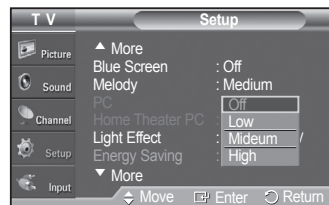
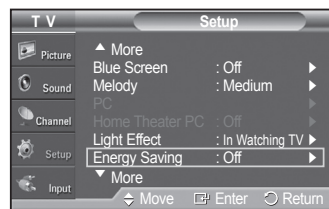

## Preventing Screen Burn-in

To reduce the possibility of screen burn, this unit is equipped with screen burn prevention technology. This technology enables you to set picture movement up/down (Vertical Line) and side to side (Horizontal Dot). The Time setting allows you to program the time between movement of the picture in minutes.

- 1 Press the **MENU** button to display the menu.  
Press the **▲** or **▼** button to select **Setup**, then press the **ENTER** button.
- 2 Press the **▲** or **▼** button to select **Screen Burn Protection**, then press the **ENTER** button.
- 3 Press the **ENTER** button to select **Pixel Shift**, then press the **ENTER** button.  
Pressing the **▲** or **▼** button will alternate between **On** and **Off**.  
You will also see the items **Horizontal Dot**, **Vertical Line** and **Time**.

- **Pixel Shift:** Using this function, you can minutely move pixels on the PDP in horizontal or vertical direction to prevent after-images on the screen.

- 4 Press the **▲** or **▼** button to select the item you wish to change, then press the **ENTER** button.  
Press the **▲** or **▼** button to change the value of the item, then press the **ENTER** button.

- Optimum condition for pixel shift;

	PC	TV/AV1/AV2/S-Video/ Component/HDMI
<b>Horizontal Dot</b>	1	2
<b>Vertical Line</b>	1	2
<b>Time(min)</b>	2	2

Press the **EXIT** button to exit.

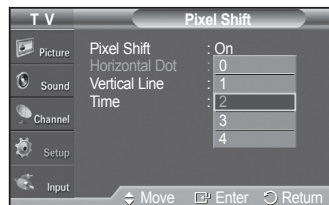
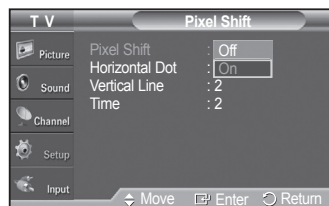
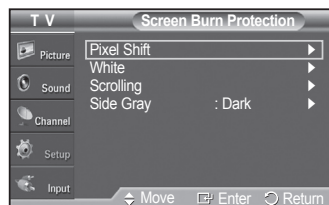
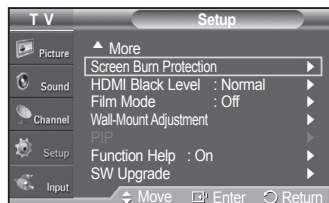

## Reducing the Effects of Screen Burn

If screen burn has occurred, you can select a white screen or scrolling to help remove screen burn artifacts.

- 1 Press the **MENU** button to display the menu.  
Press the **▲** or **▼** button to select **Setup**, then press the **ENTER** button.
- 2 Press the **▲** or **▼** button to select **Screen Burn Protection**, then press the **ENTER** button.
- 3 Press the **▲** or **▼** button to select **White**, **Scrolling**, or **Side Gray** then press the **ENTER** button.  
Press the **EXIT** button to exit.

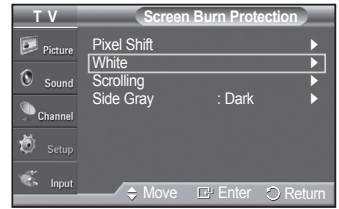

### White

This function removes after-images on the screen by changing the color of pixels to white. Use this function when there are remaining after-images or symbols on the screen especially when you displayed a still image on the screen for a long time.

### Scrolling

This function removes after-images on the screen by moving all the pixels on the PDP according to a pattern. Use this function when there are remaining after-images or symbols on the screen especially when you displayed a still image on the screen for a long time.

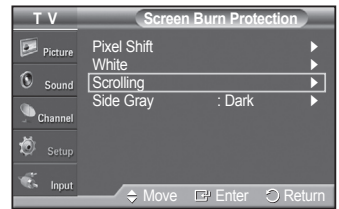

### Side Gray

When you watch TV with the screen ratio of 4:3, the screen is prevented from any damage by adjusting the white balance on both extreme left and right sides. To prevent the screen burn from happening, select Dark or Light.



- **Dark:** When you set the screen ratio to 4:3, it darkens the left and right sides.
- **Light:** When you set the screen ratio to 4:3, it brightens the left and right sides.

- To remove after-images on the screen, use either the **White** or **Scrolling** function. Although both functions remove after-images on the screen, **Scrolling** is more effective.
- The after-image removal function has to be executed for a long time (approximately 1 hour) to effectively remove after-images on the screen. If the after-image is not removed after performing the function, repeat the function again.
- Press any key on the remote control to cancel this feature.

## Setting the Function Help

Displays help on the menu functions.

- 1 Press the **MENU** button to display the menu.  
Press the **▲** or **▼** button to select **Setup**, then press the **ENTER** button.
- 2 Press the **▲** or **▼** button to select **Function Help**, then press the **ENTER** button.
- 3 Press the **▲** or **▼** button to select **Off** or **On**, then press the **ENTER** button.  
Press the **EXIT** button to exit.
  - The Function Help default setting is **On**.

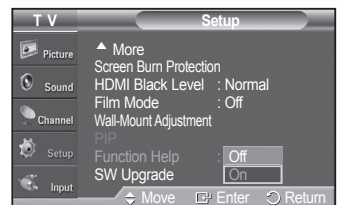
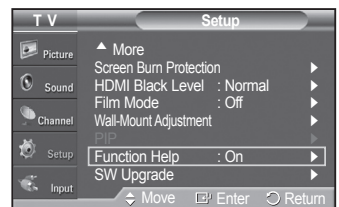

## Wall-mount adjustment (Sold separately)

Once the wall mount is installed, the position of your TV can be easily adjusted.

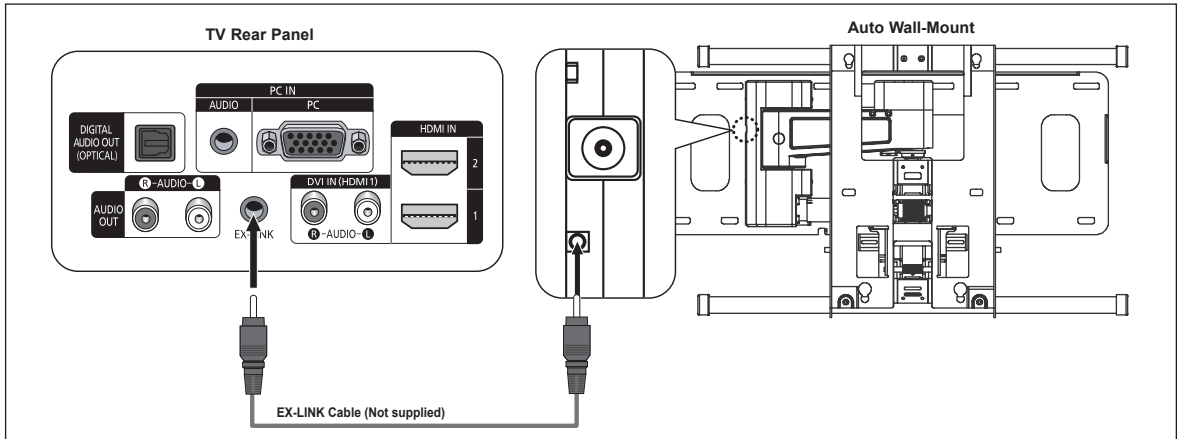

### Entering the menu

- 1 Press the **MENU** button to display the menu.  
Press the **▲** or **▼** button to select **Setup**, then press the **ENTER** button.
  - 2 Press the **▲** or **▼** button to select **Wall-Mount Adjustment**, then press the **ENTER** button.
  - 3 Adjust to the desired position using the **▲/▼/◀/▶** buttons.  
Press the **EXIT** button to exit.
- If you press an arrow button when no OSD is displayed on the TV screen, the Adjustment screen appears.
  - When you turn the power off, your TV moves to the initial installation position.  
When you turn the power on, your TV moves to the last remembered position you adjusted.

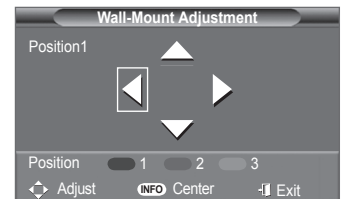
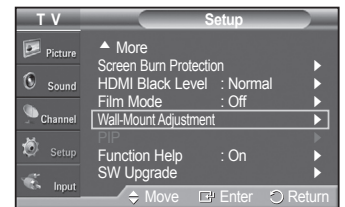

### Using the remote Control Buttons

Button	Operations	
	Wall-mount angle adjustment	Tilt Up, Tilt Down, Move right, Move left
	Reset	Moves to the initial installation position
	Remembering the position and moving to the remembered position	Remembers 3 positions with the Red, Green and Yellow buttons. Moves to the remembered position using these 3 color buttons.

- For installation, refer to the Installation Manual provided.
- For product installation and the installation and moving of the wall mount, make sure to consult a specialized installation company.
- This installation manual is to be used when attaching the wall mount to a wall.  
When attaching to other building materials, please contact your nearest dealer

## Upgrading the Software

Samsung may offer upgrades for your TV's firmware in the future. Please contact the Samsung call center at 1-800-SAMSUNG to receive information about downloading upgrades and using a USB drive. Upgrades will be possible by connecting a USB drive to the USB Upgrade Port located on the side of your TV.

- 1 Insert a USB drive containing the firmware upgrade into the USB Upgrade Port on the side of the TV.
- 2 Press the **MENU** button to display the menu. Press the **▲** or **▼** button to select **Setup**, then press the **ENTER** button.
- 3 Press the **▲** or **▼** button to select **SW Upgrade**, then press the **ENTER** button.
- 4 Press the **▲** or **▼** button to select **USB**, then press the **ENTER** button. The message **Scanning for USB... It may take up to 30 seconds.** is displayed.
- 5 If the firmware on the USB is properly recognized, the message **Upgrade version xxxx to version xxxx? The system would be reset after upgrade.** is displayed. Press the **◀** or **▶** button to select **OK**, then press the **ENTER** button. The upgrade starts.

Please be careful to not disconnect the power or remove the USB drive while upgrades are being applied.

The TV will shut off and turn on automatically after completing the firmware upgrade.

Please check the firmware version after the upgrades are complete.

➤ The firmware and upgrade process may be different by country and region.

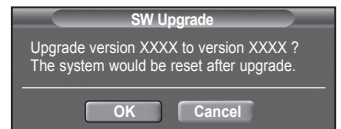
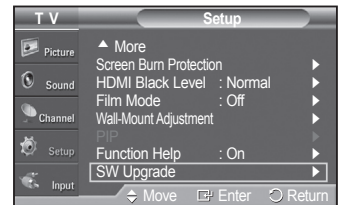
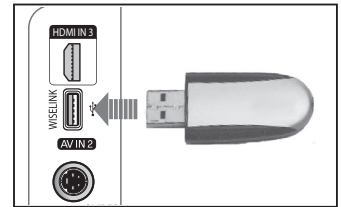

## Using the V-Chip

U.S.A Only

This product is covered by the following U.S. patents : US4,930,158 US4,930,160

The V-Chip feature automatically locks out programs that are deemed inappropriate for children. The user must enter a PIN (personal ID number) before any of the V-Chip restrictions are set up or changed.

- When the V-Chip feature is activated, the PIP features do not function.
- The V-Chip does not work if the input is Digital TV (HD or SD).
- V-Chip function is not available in HDMI or component mode.

### Setting Up Your Personal ID Number (PIN)

- 1 Press the **MENU** button to display the menu. Press the **▲** or **▼** button to select **Setup**, then press the **ENTER** button.
- 2 Press the **▲** or **▼** button to select **V-Chip**, then press the **ENTER** button. The message **Enter PIN** will appear. Enter your 4 digit PIN number.
  - The default PIN number of a new TV set is **0-0-0-0**.

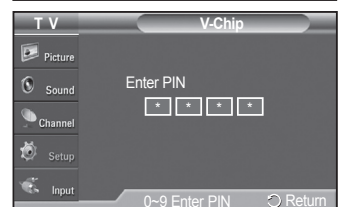
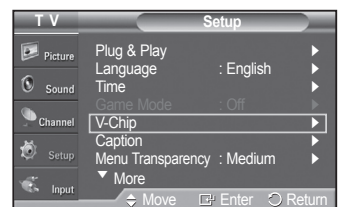

*Continued...*



- The **V-Chip** screen will appear. Press the **▲** or **▼** button to select **Change PIN**, then press the **ENTER** button. The Change PIN screen will appear. Choose any 4 digits for your PIN and enter them. Re-enter the same 4 digits. When the message **PIN is changed successfully.** is displayed, your PIN has been memorized.

Press the **EXIT** button to exit.

- If you forget the PIN, press the remote-control buttons in the following sequence, which resets the pin to 0-0-0-0 : Power Off. → MUTE → 8 → 2 → 4 → Power On.



<for USA models only>



<for Canada models only>

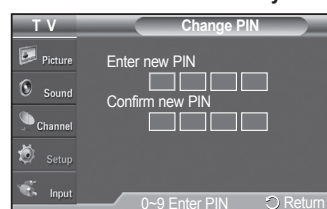

### How to Enable/Disable the V-Chip

- Press the **MENU** button to display the menu. Press the **▲** or **▼** button to select **Setup**, then press the **ENTER** button.
- Press the **▲** or **▼** button to select **V-Chip**, then press the **ENTER** button. The message **Enter PIN** will appear. Enter your 4 digit PIN number.
- The **V-Chip** screen will appear. To enable the V-Chip feature, press the **ENTER** button so that the **V-Chip Lock** field is **On**. (Pressing the **▲** or **▼** button will alternate between **On** and **Off**.) Press the **ENTER** button.
  - While V-Chip is in operation, the Still function cannot be used. Press the **EXIT** button to exit.

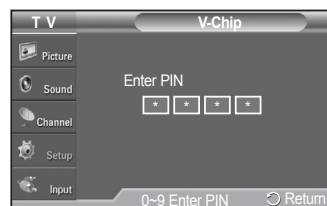

### How to Set up Restrictions Using “TV Parental Guidelines”

First, set up a personal identification number (PIN), and enable the V-Chip. (See previous section.) Parental restrictions can be set up using either of two methods: The TV guidelines or the MPA A rating.

- Press the **MENU** button to display the menu. Press the **▲** or **▼** button to select **Setup**, then press the **ENTER** button.
- Press the **▲** or **▼** button to select **V-Chip**, then press the **ENTER** button. The message **Enter PIN** will appear. Enter your 4 digit PIN number.

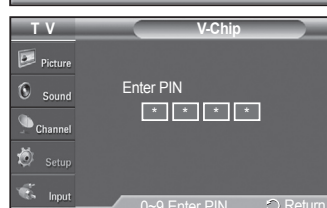

*Continued...*

3 The **V-Chip** screen will appear. Press the ▲ or ▼ button to select **TV Parental Guidelines**, then press the **ENTER** button.

4 The **TV Parental Guidelines** screen will appear. Press the ▲ or ▼ button to select one of the six aged based categories:

- **TV-Y:** All children. The themes and elements in this program are specifically designed for a very young audience, including children from ages two to six.
- **TV-Y7:** Directed to older children. The themes and elements in this program may include mild physical or comedic violence, or may frighten children under the age of seven.
- **TV-G:** General audience. It contains little or no violence, no strong language, and little or no sexual dialog or situations.
- **TV-PG:** Parental guidance suggested. This program may contain infrequent coarse language, limited violence, some suggestive sexual dialog and situations.
- **TV-14:** Parents strongly cautioned. This program may contain sophisticated themes, sexual content, strong language and more intense violence.
- **TV-MA:** Mature audiences only. This program may contain mature themes, profane language, graphic violence and explicit sexual content.



5 At this point, one of the TV-Ratings is selected. Press the **ENTER** button. Depending on your existing setup, the “🔒” symbol will be selected. (Blank = Unblocked, 🔒 = Blocked) While “🔒” is selected, press the **ENTER** button to block or unblock the category.

To select a different TV-Rating, press the ▲ or ▼ button and then repeat the process.

- **Allow all:** Press to unlock all TV ratings.
- **Block all:** Press to lock all TV ratings.
- The TV-Y, TV-Y7, TV-G, TV-PG, TV-14 and TV-MA have additional options. See the next step to change any of the following sub-ratings:

- **FV:** Fantasy violence.
- **D:** Sexually suggestive dialog.
- **L:** Adult language.
- **S:** Sexual situation.
- **V:** Violence.

- The V-Chip will automatically block certain categories that are “more restrictive”. For example, if you block **TV-Y** category, then TV-Y7 will automatically be blocked. Similarly, if you block the TV-G category, then all the categories in the “young adult” group will be blocked (TV-G, TV-PG, TV-14, and TV-MA). The subratings (D, L, S, V) work together similarly. (See next section.)

6 How to set the FV, D, L, S and V sub-ratings. First, select one of these TV-Ratings: TV-Y, TV-Y7, TV-G, TV-PG, TV-14, or TV-MA (See Step 4), and press the **ENTER** button. The “🔒” symbol will be displayed for each sub-rating. While “🔒” is selected, press the ► button to go to a sub rating. Press the **ENTER** to block the sub rating. To select a different TV-Rating, press the ▲ or ▼ button and then repeat the process.

7 Press the **EXIT** button to clear all the screens. (Or proceed to the next section, and set up additional restrictions based on the MPAA codes.)

- These categories consist of two separate groups: TV-Y and TV-Y7 (young children through age 7), and TV-G through TV-MA (everybody else). The restrictions for these two groups work independently: If a household includes very young children as well as young adults, the TV guidelines must be set up separately for each age group.

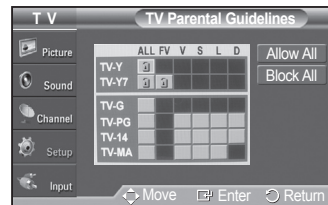

*Continued...*

## How to Set up Restrictions Using “MPAA Ratings” (G, PG, PG-13, R, NC-17, X, NR)

The MPAA rating system uses the Motion Picture Association of America (MPAA) system, and its main application is for movies. When the V-Chip lock is on, the TV will automatically block any programs that are coded with objectionable ratings (either MPAA or TV-Ratings).

- 1 Press the **MENU** button to display the menu.  
Press the **▲** or **▼** button to select **Setup**, then press the **ENTER** button.
- 2 Press the **▲** or **▼** button to select **V-Chip**, then press the **ENTER** button.  
The message **Enter PIN** will appear. Enter your 4 digit PIN number.
- 3 The **V-Chip** screen will appear. Press the **▲** or **▼** button to select **MPAA Rating**, then press the **ENTER** button.
- 4 Press the **▲** or **▼** button to select an appropriate restriction.  
Press the **ENTER** button to activate the restriction selected.  
The “**🔒**” symbol is indicated. While “**🔒**” is selected, press the **ENTER** button to block or unblock the category.

Press the **EXIT** button to exit.

- **Allow all:** Press to unlock all TV ratings.
- Block all:** Press to lock all TV ratings.

- **G:** General audience (no restriction).
- **PG:** Parental guidance suggested.
- **PG-13:** Parents strongly cautioned.
- **R:** Restricted. Children under 17 should be accompanied by an adult.
- **NC-17:** No children under age 17.
- **X:** Adults only.
- **NR:** Not rated.

- The V-Chip will automatically block any category that is “more restrictive”.  
For example, if you block the PG-13 category, then R, NC-17 and X will automatically be blocked also.

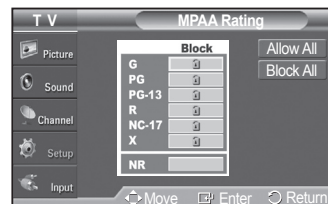
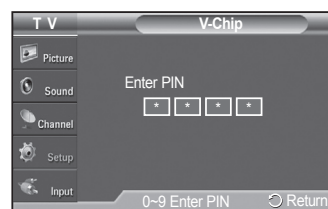

## How to Set up Restrictions Using “Canadian English” (for Canada Models)

- 1 Press the **MENU** button to display the menu.  
Press the **▲** or **▼** button to select **Setup**, then press the **ENTER** button.
- 2 Press the **▲** or **▼** button to select **V-Chip**, then press the **ENTER** button.  
The message **Enter PIN** will appear. Enter your 4 digit PIN number.

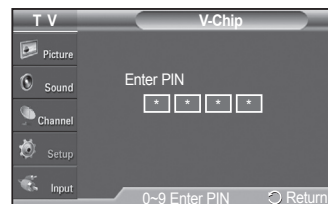

*Continued...*

- 3 The **V-Chip** screen will appear. Press the **▲** or **▼** button to select **Canadian English**, then press the **ENTER** button

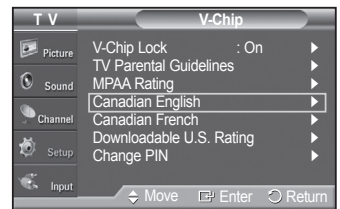

- 4 Press the **▲** or **▼** button to select an appropriate restriction. Press the **ENTER** button to activate the restriction selected. The “**🔒**” symbol is indicated.

Press the **EXIT** button to exit.

- **Allow all:** Press to unlock all TV ratings.
- Block all:** Press to lock all TV ratings.

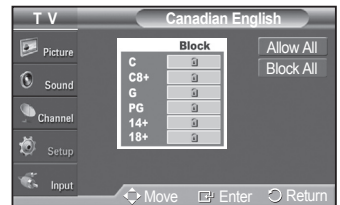

- **C:** Programming intended for children under age 8.
- **C8+:** Programming generally considered acceptable for children 8 years and over to watch on their own.
- **G:** General programming, suitable for all audiences.
- **PG:** Parental guidance.
- **14+:** Programming contains themes or content which may not be suitable for viewers under the age of 14.
- **18+:** Adult programming.

- The V-Chip will automatically block any category that is “more restrictive”. For example, if you block G category, then PG, 14+ and 18+ will automatically be blocked also.

### How to Set up Restrictions Using “Canadian French” (for Canada Models)

- 1 Press the **MENU** button to display the menu. Press the **▲** or **▼** button to select **Setup**, then press the **ENTER** button.
- 2 Press the **▲** or **▼** button to select **V-Chip**, then press the **ENTER** button. The message **Enter PIN** will appear. Enter your 4 digit PIN number.
- 3 The **V-Chip** screen will appear. Press the **▲** or **▼** button to select **Canadian French**, then press the **ENTER** button.
- 4 Press the **▲** or **▼** button to select an appropriate restriction. Press the **ENTER** button to activate the restriction selected. The “**🔒**” symbol is indicated.

Press the **EXIT** button to exit.

- **Allow all:** Press to unlock all TV ratings.
- Block all:** Press to lock all TV ratings.



- **G:** General.
- **8 ans+:** Not recommended for young children.
- **13 ans+:** Programming may not be suitable for children under the age of 13.
- **16 ans+:** Programming is not suitable for children under the age of 16.
- **18 ans+:** Programming restricted to adults.

- The V-Chip will automatically block any category that is “more restrictive”. For example, if you block 8 ans+ category, then 13 ans+, 16 ans+ and 18 ans+ will automatically be blocked also.

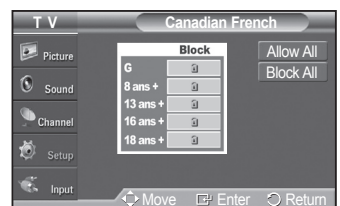
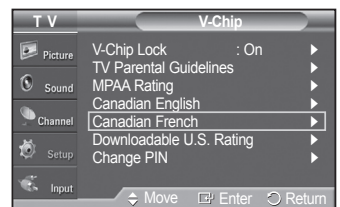

## Using the V-Chip for Digital channels

Parental restriction information can be used while watching DTV channels.

- 1 Press the **MENU** button to display the menu.  
Press the **▲** or **▼** button to select **Setup**, then press the **ENTER** button.
- 2 Press the **▲** or **▼** button to select **V-Chip**, then press the **ENTER** button.  
The message **Enter PIN** will appear. Enter your 4 digit PIN number.
- 3 The **V-Chip** screen will appear. Press the **▲** or **▼** button to select **Downloadable U.S. Rating**, then press the **ENTER** button.
  - If information is not downloaded from the broadcasting station, the **Downloadable U.S. Rating** menu is deactivated.
  - Parental restriction information is automatically downloaded while watching DTV channels. It may take several seconds.
  - The **Downloadable U.S. Rating** menu is available for use after information is downloaded from the broadcasting station. However, depending on the information from the broadcasting station, it may not be available for use.
- 4 Press the **▲** or **▼** button to select an appropriate restriction  
Press the **ENTER** button to activate the restriction selected.  
The “**🔒**” symbol is indicated.

Press the **EXIT** button to exit.

- **Allow all:** Press to unlock all TV ratings.
- **Block all:** Press to lock all TV ratings.
- Parental restriction levels differ depending on the broadcasting station.
- The default menu name and downloadable US rating changes depending on the downloaded information.
- Even if you set the on-screen display to your desired language, the **Downloadable U.S. Rating** menu will appear in English only.
- The rating will automatically block certain categories that are more restrictive.
- The rating titles (for example: Humor Level..etc) and TV ratings (for example: DH,MH,H..etc) may differ depending on the broadcasting station.

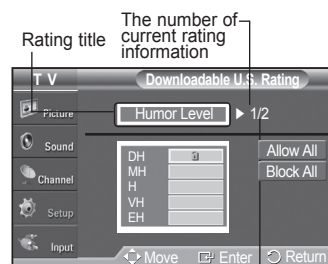
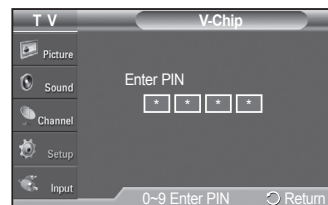

Rating title  
The number of current rating information

The number of all the rating information

## How to Reset the TV after the V-Chip Blocks a Channel (“Emergency Escape”)

If the TV is tuned to a restricted channel, the V-Chip will block it. The screen will go blank and the following message will appear:

- 1 Enter your PIN.  
To resume normal viewing, tune to a different channel using **CH ▲** or **CH ▼** button. Under certain conditions (depending on the rating of the local TV programs) the V-Chip might lock out all the channels. In this case, use the V-Chip function for an “emergency escape”:
- 1 Press the **MENU** button. Press the **▲** or **▼** button to select **Setup**, then press the **ENTER** button.
- 2 Press the **▲** or **▼** button to select **V-Chip**, then press the **ENTER** button.
- 3 Enter your PIN, then press the **ENTER** button, and press the **▲** or **▼** button to temporarily disable the V-Chip Lock.
  - If you forget the PIN, press the remote-control buttons in the following sequence, which resets the pin to 0-0-0-0 : Power Off. → MUTE → 8 → 2 → 4 → Power On.

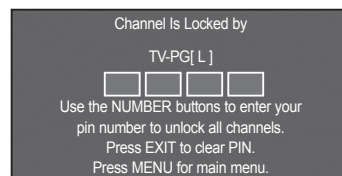
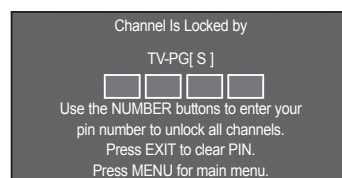

## Using the WISELINK Function

This function enables you to view and listen to photo (BASELINE, JPEG) and audio files (MP3) saved on a memory device.

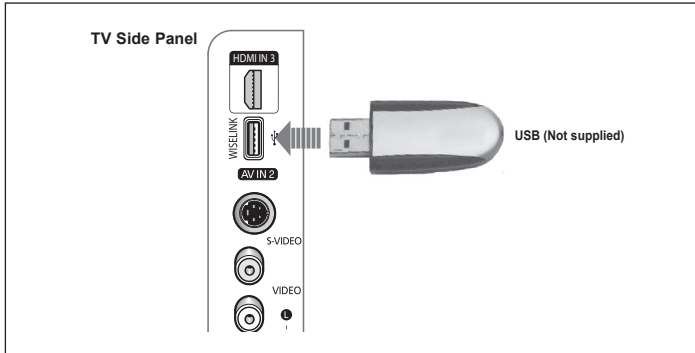

Insert an USB device containing JPEG and/or MP3 files into the WISELINK jack (USB jack) on the side of the TV.

- Do not apply excessive force when you insert/eject the memory card or USB device.
- Do not place the memory card or USB device near a strong electro-magnetic device.
- Do not allow metal substances to come in contact with the terminals on the memory card.
- Do not bend, drop or apply strong shock to memory cards or USB devices.
- Only alphanumeric characters must be used as a filename (photo, music). The filename with non-alphanumeric characters is displayed with “???”.
- If a filename is too long, the filename is represented as follows: “filename...+.jpg” or “filename...+.mp3”.
- The file system supports FAT16/32, not NTFS.
- Certain types of USB Digital camera and audio devices may not be compatible with this TV.
- WISELINK only supports USB Mass Storage Class devices (MSC). MSC is a Mass Storage Class Bulk-Only Transport device. Examples of MSC are Thumb drives and Flash Card Readers. It does not support USB HDD and HUB.
- Before inserting your memory card or USB device into the TV, please back up your files. SAMSUNG is not responsible for any data file damage or data loss.
- The data files in memory cards might be erased due to electrostatic discharge (EST), loose contact, or dust.
- Some memory devices may not be recognized when the TV is turned on and switched to WISELINK Mode. If this occurs, remove and reinstall the memory device in question.
- This product supports USB devices that have only 512byte data block size.
- Directly connect the USB device to the USB jack on your TV. Compatibility problems may occur when using an USB hub.
- We recommended using the sequential JPEG format. If the progressive JPEG mode is used, decoding may fail due to use of much memory.
- When the loading (⏳ Loading) icon is displayed, don't pull off the USB device.
- PTP (Picture Transfer Protocol) or MTP (Media Transfer Protocol) is not supported on this TV.
- USB devices that require their own driver CDs may not be recognized. (When the USB device is connected to the PC, Windows searches the eligible driver for the device. But the USB device is not the bulk-only device so you cannot use it on the PC.)

## Using the WISELINK Mode

- 1 Press the **MENU** button to display the menu.  
Press the **ENTER** button to select **Input**.  
Press the **▲** or **▼** button to select **WISELINK**, then press the **ENTER** button.

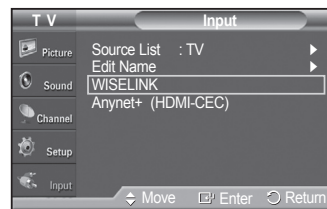

- 2 Press the **▲** or **▼** button to select a corresponding memory device, then press the **ENTER** button.  
A menu for selecting the Photo or Music files or setup function on a selected memory device will be displayed.

- The WISELINK menu differs depending on the USB Memory Device connected to TV.



- 3 Press the **◀** or **▶** button to select an icon (**Photo**, **Music** or **Setup**), then press the **ENTER** button.

To exit WISELINK mode, press the **WISELINK** button on the remote control.

- Exit the screen by pressing the WISELINK button on the remote control, and enter the WISELINK screen again.



- 4 Press the **WISELINK** button on the remote control to turn on the WISELINK mode.



### Using the Remote Control Button in WISELINK Menu

Button	Operations
	Move the cursor and select an item
	Select the currently selected item.
	Play or pause the Slide Show or MP3 file.
	Return to the previous menu.
	Stop the current function and return to the previous high-level menu.
	Run various functions from the Photo and Music menus.
	Stop the current slide show or MP3 file.
	Page Up or Down (file list item)

## Using the Photo (JPEG) List

You can play back the JPEG files saved on a memory device in various ways.

- 1 After switching the mode to WISELINK, select a memory device that you have installed. (Refer to page 63)
  - 2 Press the ◀ or ▶ button to select **Photo**, then press the **ENTER** button. JPEG files and existing folders are displayed.
  - 3 Press the ▲/▼/◀/▶ buttons to select a file, then press the **ENTER** button.
    - Pressing the button over a photo icon displays the currently selected photo in full screen. However, JPEG files smaller than 640x480 pixels are zoomed-in at 4 times their original size. (e.g. If a photo's original size is 200x200 pixels It is displayed at 800x800 pixels)
    - Press the **INFO** button and select **View** to view a photo image at its original size.
    - Pressing the button over a folder icon shows the JPEG files included in the folder.
    - While a full screen is displayed, ◀ or ▶ buttons will let you see another photo image in the same folder.
    - Press the **PLAY/PAUSE** button when a Photo icon is selected to start a Slide Show.
- To exit WISELINK mode, press the **WISELINK** button on the remote control.
- Moving to a photo may take a few seconds because the file needs to be loaded. At this point, the icon will appear.
  - This menu shows only the files whose extension is jpeg (or jpg). Files with other formats such as gif or tiff will not be displayed.
  - Fifteen thumbnail photos are displayed per page.
  - The thumbnails are numbered from left to right and from top to bottom, from 1 to 15.
  - Folders are displayed first and they are followed by all JPEG files in the current folder. The folders and JPEG files are sorted in alphabetical order.
  - If the photo is displayed in full screen, you can zoom in and out or rotate the photo on the screen. (Refer to pages 68~69)
  - It takes a while to show JPEG files as thumbnail images.
  - WISELINK for this product supports JPEG files up to 8K x 8K pixels. For progressive JPEG files or files whose size exceeds 8MB, the photo will be displayed as a thumbnail only. When trying to view a progressive JPEG file, the **Not supported mode** message will appear. When trying to view a file exceeding 8MB, the **This file is too large to decode** message will appear.
  - The higher the image resolution advances, the longer the display time takes.
  - You cannot decode images beyond a horizontal resolution of 5000.
  - You cannot decode images beyond a vertical resolution of 4000.



 : Folder icon

 : Photo icon

 : Move to the previous folder stage icon

 Press the **WISELINK** button on the remote control to turn on the WISELINK mode.





## Using the Options Menu

### **Start Slide Show:**

Starts a slide show.

(Refer to **Viewing a Slide Show** on page 66)



### **Rotate:**

You can rotate images in full screen mode.

Images are rotated in the order of 90°, 180°, 270° and 0° (original state).

(Refer to **Rotating** on page 68)

- You cannot save a rotated image.
- It may take long time to rotate the large-size file.



### **Zoom:**

You can zoom into images in full screen mode.

Images are zoomed in the order of X2, X4 and X1 (original size).

(Refer to **Zooming-In** on page 69)

- You cannot save a zoomed-in image.
- When the JPEG image resolution is greater than the screen size, you cannot use the Zoom function.
- Zoom function is not available for the image files that have the resolution of 1280x720 or greater.



### **List:**

Displays the stored files, folders and file info.

- The **File Error** message appears on the screen in the following situations:
  - When the file actually has an error
  - If the target memory cannot be written to when copying files
  - If the target memory does not have enough space when copying files



*Continued...*

## Viewing a Slide Show

- 1 After switching the mode to WISELINK, select a memory device that you have installed. (Refer to page 63)
  - 2 Press the ◀ or ▶ button to select **Photo**, then press the **ENTER** button. JPEG files and existing folders are displayed.
  - 3 Press the **INFO** button to display the option (**Start Slide Show, Deselect All**).
  - 4 Press the ▲ or ▼ button to select **Start Slide Show**, then press the **ENTER** button.
    - Slide show displays all JPEG files in the selected folder at a pre-set speed.
    - During the slide show, files are displayed in order from the currently shown file.
    - MP3 files can be automatically played during the slide show if the **Default Background Music** is set to **On**. To enable this function, MP3 files and other photo files must be located in the same folder on the memory device.
    - To run the slide show repeatedly, change the setting by referring to page 71.
    - Press the **PLAY/PAUSE** button when a Photo icon is selected to start a Slide Show.
  - 5 Press the **INFO** button during slide show to set the option (**Slide show Speed, Background Music, Background Music Setting, List**).
  - 6 Press the ▲ or ▼ button to select the option, then press the **ENTER** button.
-  Press the **WISELINK** button on the remote control to turn on the WISELINK mode.



*Continued...*

## Using the Menu during a Slide Show

### Slide show Speed:

Select to control the slide show speed. Each time the **ENTER** button is pressed, the speed changes repeatedly. (Normal → Slow → Fast)

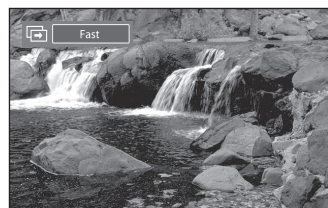

### Background Music:

Select to choose whether you want to play MP3 file during a slide show. Each time the **ENTER** button is pressed, the background music activation changes repeatedly. (On → Off)

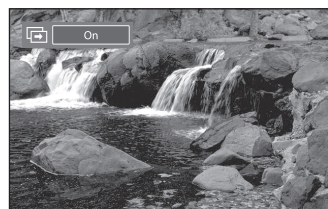

### Background Music Setting:

While the slide show is in progress, MP3 files and folders under the same directory are displayed.

Select a folder using the ▲ or ▼ buttons and press the **ENTER** button.

The selected folder will be highlighted.

Press the **RETURN** button again to return to the slide show screen.

The selected background music is played.

- If you turn Off the Background Music, even if the Background Music Settings have been set up, the background music will not be played.

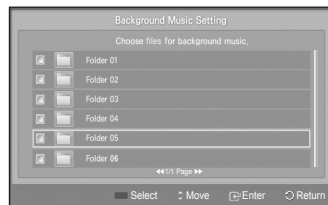

### List:

JPEG files and existing folders are displayed. To exit WISELINK mode, press the **WISELINK** button on the remote control. Press the **EXIT** button to switch to the WISELINK start screen where another memory card can be selected.

- When selecting a photo file, the photo file information is displayed on the left in the TV screen, such as the resolution, the size, the date modified and the order of the file in the current directory.

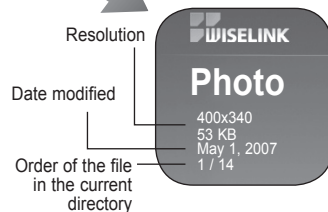

Continued...

## Rotating

- 1 After switching the mode to WISELINK, select a memory device that you have installed. (Refer to page 63)
- 2 Press the ◀ or ▶ button to select **Photo**, then press the **ENTER** button. JPEG files and existing folders are displayed.
- 3 Press the ▲/▼/◀/▶ buttons to select a file, then press the **ENTER** button. Pressing the button over a photo icon shows the currently selected photo in full screen.
- 4 Press the **INFO** button to display the option (**Start Slide Show, Rotate, Zoom, List**). Press the ▲ or ▼ button to select **Rotate**, then press the **ENTER** button. Each time the **ENTER** button is pressed, the photo rotates repeatedly. (90° → 180° → 270° → 0°)
  - Rotating directly from 90 degrees to 270 degrees is not possible.
  - When rotating a photo, the edge of the photo may not be displayed on the screen.

To exit WISELINK mode, press the **WISELINK** button on the remote control.

  - The rotated file is not saved.

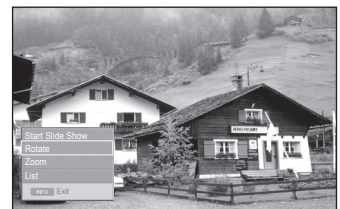

### The Rotating function information icon (Displayed at the top left of the screen).

Icon	Current OSD	Function
	Rotating (90°)	To rotate a photo by 90 degrees
	Rotating (180°)	To rotate a photo by 180 degrees
	Rotating (270°)	To rotate a photo by 270 degrees
	Rotating (0°)	To rotate a photo by original

Press the **WISELINK** button on the remote control to turn on the WISELINK mode.



*Continued...*

## Zooming-In

- 1 After switching the mode to WISELINK, select a memory device that you have installed. (Refer to page 63)
- 2 Press the ◀ or ▶ button to select **Photo**, then press the **ENTER** button. JPEG files and existing folders are displayed.



- 3 Press the ▲/▼/◀/▶ buttons to select a file, then press the **ENTER** button. Pressing the button over a photo icon shows the currently selected photo in full screen.



- 4 Press the **INFO** button to display the option (**Start Slide Show, Rotate, Zoom, List**).

Press the ▲ or ▼ button to select **Zoom**, then press the **ENTER** button. Each time the **ENTER** button is pressed, the photo size increases. (X1 → X2 → X4)

- **X1**: Restore the photo to its original size.
- **X2**: Zoom-in to the photo X2.
- **X4**: Zoom-in to the photo X4.

To move the enlarged photo image up/down/left/right, press the ▲/▼/◀/▶ buttons.

To exit WISELINK mode, press the **WISELINK** button on the remote control.



### Zoom function information icon (Displayed at the top left of the screen).

Icon	Current OSD	Function
	Zoom (x 2)	Zoom-in to a photo x2.
	Zoom (x 4)	Zoom-in to a photo x4.
	Zoom (x 1)	Restore a photo to its original size.
	Pan Down	Pan down to view the lower part of a zoomed-in photo.
	Pan Up	Pan up to view the upper part of a zoomed-in photo.
	Pan Right	Pan right to view the right side of a zoomed-in photo.
	Pan Left	Pan left to view the left side of a zoomed-in photo.
	Pan Down (END)	Pan to the bottom of a zoomed-in photo
	Pan Up (END)	Pan to the top of a zoomed-in photo.
	Pan Right (END)	Pan to the right-most part of a zoomed-in photo.
	Pan Left (END)	Pan to the left-most part of a zoomed-in photo.

- Press the **WISELINK** button on the remote control to turn on the WISELINK mode.

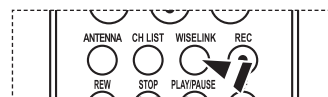

# Using the Music (MP3) List

You can play back the MP3 files saved on a memory device in various ways.

- 1 After switching the mode to WISELINK, select a memory device that you have installed. (Refer to page 63)
- 2 Press the ◀ or ▶ button to select **Music**, then press the **ENTER** button. MP3 files and existing folders are displayed.
- 3 Press the ▲ or ▼ buttons to select a file to be played, then press the **ENTER** button.
  - Pressing the **ENTER** button while a music file is highlighted immediately plays the music file.
  - Pressing the **ENTER** button while a folder is highlighted shows the music files in the folder.
  - To select a file on the next page, press the **REW** or **FF** button.
- 4 To select all files, press the **INFO** button to display the music menu. Press the ▲ or ▼ button to select **Play All Files**, then press the **ENTER** button. All the MP3 files under the same folder will be played.
  - To play back the files repeatedly, change the setting by referring to page 71.
- 5 Press the **PLAY/PAUSE** button while playing an MP3 file to pause the file. Press the **STOP** button to stop playback.
 

To exit WISELINK mode, press the **WISELINK** button on the remote control.

  - This menu shows only the files whose extension is mp3. Files with other extensions are not displayed, even if they have been saved on the same memory device.
  - The selected file is displayed on the top of the screen with its playing time.
  - To adjust the music volume, press the **VOL+** or **VOL-** button on the remote control.

To mute the sound, press the **MUTE** button on the remote control.

  - FF and REW functions do not work during the play. When those buttons are pressed, the play stops.
  - The playing time of each MP3 file can be found in the file information. When not found, it may be displayed as 00:00:00.

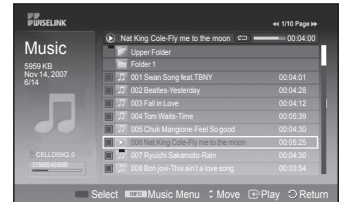
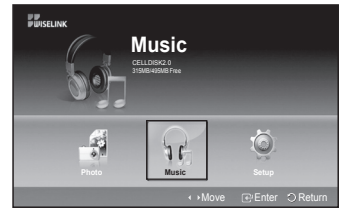

: Folder icon

: Music list icon

: Move to the previous folder stage icon

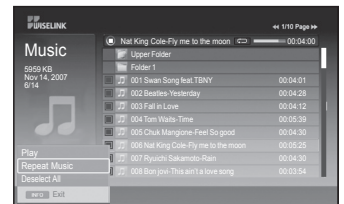

## Music function information icon (Displayed at the top left of the screen).

Icon	Current OSD	Function
	(Music) All Repeat	When all music files in the folder are repeated.
	(Music) All	When all music files in the folder are played once.
	(Music) Play/Pause	When pressing the <b>PLAY/PAUSE</b> button on the remote control while music is playing. The music stops and the 'Play' text appears at the top of the screen.
	(Music) Stop	When pressing the <b>STOP</b> button on the remote control when music is stopped. The music resumes and the 'Stop' text appears at the top of the screen.

Press the **WISELINK** button on the remote control to turn on the WISELINK mode.



# Using the Setup Menu

Setup displays the user settings of the WISELINK menu

- 1 After switching the mode to WISELINK, select a memory device that you have installed. (Refer to page 63)
- 2 Press the ◀ or ▶ button to select **Setup**, then press the **ENTER** button. The Setup menu is displayed.
- 3 Press the ▲ or ▼ button to select an item you want, then press the **ENTER** button.
- 4 Press the ▲ or ▼ button to select the option, then press the **ENTER** button.

## Slide Show Speed:

Select to control the slide show speed. You can select **Fast**, **Normal** or **Slow**.

## Background Music:

Select to determine whether to play an MP3 file during a slide show. You can select Background Music **On** or Music **Off**.

## Background Music Setting:

While the slide show is in progress, use the Background Music Setting to select a music file to listen to. Select an MP3 file as the background music.

## Repeat Music:

- **On:** Plays back a music file or all music files repeatedly.
- **Off:** Doesn't play back repeatedly.

## Screen Saver:

Select to set the waiting time before the screen saver is run when no button is pressed. You can select Screen Saver **5 min** or Screen Saver **10 min**.

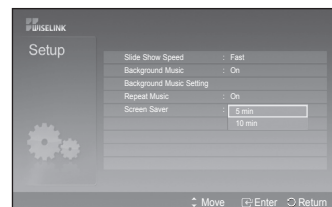
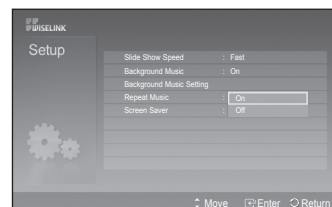
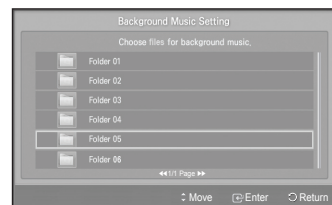
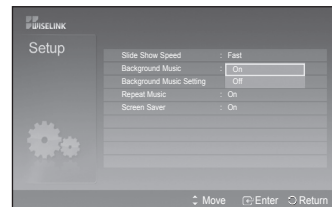
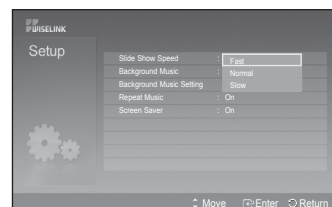
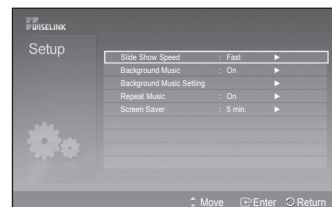

 Press the **WISELINK** button on the remote control to turn on the WISELINK mode.



# About Anynet+

## What is Anynet+?

Anynet+ is an AV network system that enables you to control all connected Samsung AV devices with your Samsung TV's remote.

## Connecting Anynet+ Devices

The Anynet+ system can be used only with Samsung AV devices that have the Anynet+ feature. To be sure your Samsung AV device has this feature, check if there is an Anynet+ mark on it.

### To directly connect to TV

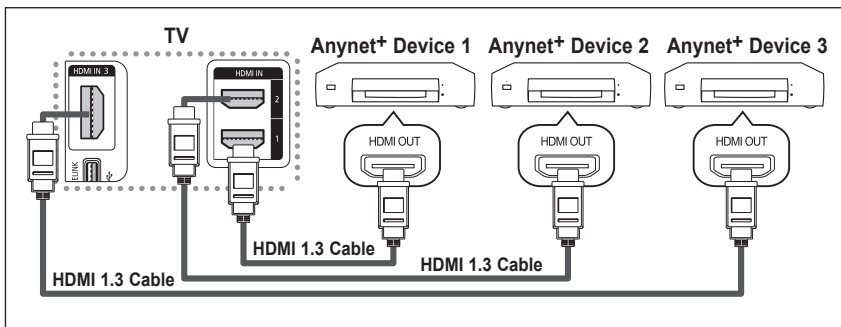

Connect the [HDMI 1], [HDMI 2] or [HDMI 3] jack on the TV and the HDMI OUT jack of the corresponding Anynet+ device using the HDMI cable.

### To connect to Home Theater

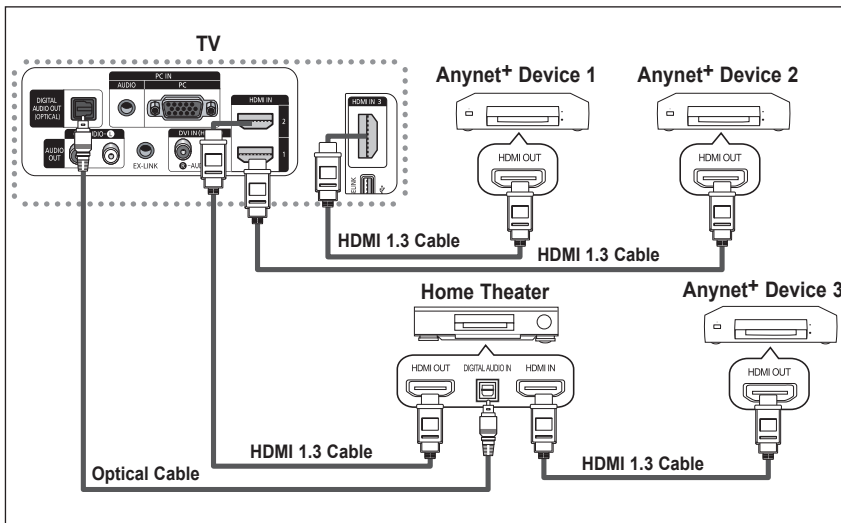

1. Connect the [HDMI 1], [HDMI 2] or [HDMI 3] jack on the TV and the HDMI OUT jack of the corresponding Anynet+ device using the HDMI cable.
2. Connect the HDMI IN jack of the home theater and the HDMI OUT jack of the corresponding Anynet+ device using the HDMI cable.

- Connect the Optical cable between [Digital Audio Out (Optical)] on your TV and Digital Audio Input on the Home Theater.
- Connect only one Home Theater.
- You can listen to 5.1 channel sound through the home theater's speakers. Otherwise, you can only listen to 2 channel stereo sound in other cases. Make sure to connect the Digital Audio IN (Optical) of the home theater and the TV correctly to listen to TV sound through the home theater. However, you cannot listen to sound from the BD recorder that is sent to the home theater via the TV in 5.1 channel sound because the TV outputs only 2 channel stereo sound. Please see the manual for the home theater.
- You can connect an Anynet+ device using the HDMI 1.3 cable. Some HDMI cables may not support Anynet+ functions.
- Anynet+ works when the AV device supporting Anynet+ is in the Standby or On status.
- Anynet+ supports up to 12 AV devices in total.



## Setting Up Anynet+

The following settings are to use Anynet+ functions.

### To use the Anynet+ Function, Anynet+ (HDMI-CEC) must be set to On

- 1 Press the **Anynet+** button.  
Press the **▲** or **▼** button to select **Setup**, then press the **ENTER** button.
- 2 Press the **ENTER** button to select **Anynet+ (HDMI-CEC)**, then press the **ENTER** button.
- 3 Press the **▲** or **▼** button to select **On**, then press the **ENTER** button.
  - The Anynet+ (HDMI-CEC) function is enabled.
  - If you select **Off**, Anynet+ (HDMI-CEC) is disabled.
  - When the Anynet+ (HDMI-CEC) function is disabled, all the Anynet+ related operations are deactivated.

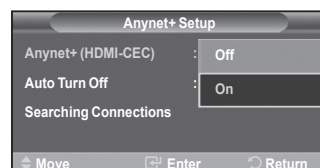

### Setting an Anynet+ Device to turn Off Automatically when the TV is Turned Off

- 2 Press the **▲** or **▼** button to select **Auto Turn Off**, then press the **ENTER** button.
- 3 Press the **▲** or **▼** button to select **On**, then press the **ENTER** button.
  - The Auto turn off function is enabled.
  - If you select **Off**, the Auto turn off function is canceled.

Press the **EXIT** button to exit.

- The Select Device setting of the TV remote control is to be set to TV to use the Anynet+ function.
- If you set Auto Turn Off to On, connected external devices are also turned off when the TV is turned off. However, if the device is recording, it may not be turned off.

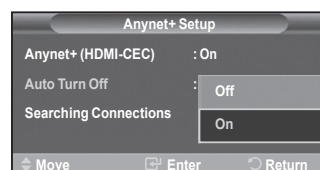

## Scanning and Switching between Anynet+ Devices

- 1 Press the **Anynet+** button.
  - Anynet+ devices connected with the TV are listed.
- 2 Press the **▲** or **▼** button to select a particular device and press the **ENTER** button. It is switched to the selected device.
- 3 If you cannot find a device you want, press the **▲** or **▼** button to select **Searching Connections**, then press the **ENTER** button.

The message **Configuring Anynet+ connection...** is displayed.  
When searching devices completes, the connected devices are listed in the Anynet+ menu.

- Switching to the selected devices may take up to 2 minutes. You cannot cancel the operation during the switching operation.
- The time required to scan for devices is determined by the number of connected devices.
- When the device scan is complete, the number of found devices is not displayed.
- Although the TV automatically scans devices when it is turned on using the **POWER** button, devices connected when the TV is already on are not displayed in the device list. In this case, select the Searching Connections menu to search devices.
- If you have selected external AV device by pressing the **SOURCE** button, you cannot use the Anynet+ function. Make sure to switch to an Anynet+ device by using the Anynet+ button.

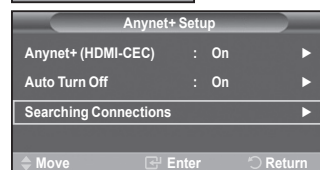

*Continued...*

## Anynet+ Menu

The Anynet+ menu changes depending on the type and status of the Anynet+ devices connected to the TV.

Anynet+ Menu	Description
View TV	Switches from Anynet+ to TV broadcast mode.
Record	Starts a recording. (This menu works only for a device supporting recording.)
(Device_Name) Menu	Shows the menu of the connected device. Example: When a DVD Recorder is connected, the DVD Recorder's title menu appears.
(Device_Name) Operation	Shows the play control menu of the connected device. Example: When a DVD Recorder is connected, the play control menu of the DVD Recorder appears.
Connect (Device_Name)	Your TV connects to the corresponding device.
Receiver	Sound is output through the receiver (home theater). A audio stream in HDMI is one way only from Device to TV. But there's SPDIF output in TV. So TV sound can be sent to HT.
Setup	You can set the Anynet+ (HDMI-CEC), auto turn off, and searching connections for using Anynet+.

## TV Remote Control Buttons Available in Anynet+ Mode

Device Type	Operating Status	Available Buttons
Anynet+ Device	After switching to the device, when the menu of the corresponding device is displayed on the screen.	Numeric buttons ▲/▼/◀/▶/ENTER buttons Color buttons EXIT button
	After switching to the device, while playing a file	◀◀ (Backward search) ▶▶ (Forward search) ■ (Stop) ▶   (Play/Pause)
Device with built-in Tuner	After switching to the device, when you are watching a TV program	CH ▲/▼ button
Audio Device	When Receiver is activated	VOL +/- button MUTE button
Anyview2	When watching TV	▶   (Play/Pause)

- The Anynet+ function only works when the remote control is set to TV.
- The **REC** button works only while in the recordable state.
- You cannot control Anynet+ devices using the buttons on the side of the TV. You can control Anynet+ devices only using the TV remote control.
- The TV remote control may not work under certain conditions. In this case, re-select the Anynet+ device.
- The Anynet+ functions don't operate for the products from other manufacturers.
- The Anynet+ functions do not work with other manufacturers' products.
- The ◀◀, ▶▶ operations may differ depending on the device.

## **Recording**

You can make a recording of a TV program using a recorder.

Press the **REC** button.

Recording begins. (Only when the Anynet+ enabled recording device is connected.)

- You can also record the source streams by selecting **Record** after pressing the Anynet+ button.
- The current TV program is recorded in the Watching TV status. If you are watching video from another device, the video from the device is recorded.
- Before recording, check whether the antenna jack is properly connected to the recording device. For the antenna connection to the recording device, refer to its user manual.

## Listening through a Receiver (Home theater)

You can listen to sound through a receiver instead of the TV speaker.

- 1 Press the **Anynet+** button.  
Press the **▲** or **▼** button to select **Receiver**, then press the **ENTER** button.
  - 2 Press the **◀** or **▶** button to select to **On**, then press the **ENTER** button.  
Now you can listen to sound through the receiver.
  - 3 Press the **EXIT** button to exit.
- When the receiver is set to On, you can listen to the TV sound through the 2-channel(Stereo) Sound. This is not always true. When TV is displaying DTV(air) TV can send out 5.1 channel sound through SPDIF. But when the source is DVD(for example), TV can receive only 2 channel sound using HDMI. In that case, 2 channel sound is only transmitted to the Receiver through SPDIF.
- If the receiver is exclusively for a home theater only (supporting audio only), it may not appear in the device list.
- Only when you have connected the optical jack of the TV and the receiver properly, does Receiver work.
- In case of a content with copyright problem, listening through the receiver may not properly operate.
- When executing WISELINK, the listening through the receiver may not work properly.
- When listening through the receiver, there are restrictions for using the PIP and audio-related menu.



## Check Points before Requesting Service

Symptom	Solution
Anynet+ does not work.	<ul style="list-style-type: none"> <li>■ Check if the device is an Anynet+ device. The Anynet+ system supports Anynet+ devices only.</li> <li>■ Connect only one receiver (home theater).</li> <li>■ Check if the Anynet+ device power cord is properly connected.</li> <li>■ Check the Anynet+ device's Video/Audio/HDMI 1.3 cable connections.</li> <li>■ Check whether Anynet+ (HDMI-CEC) is set to On in the Anynet+ setup menu.</li> <li>■ Check whether the TV remote control is in TV mode.</li> <li>■ Check whether it is Anynet+ exclusive remote control.</li> <li>■ Anynet+ doesn't work at a certain condition. (Searching channels, Operating WISELINK)</li> <li>■ When connecting or removing the HDMI 1.3 cable, please make sure to search devices again or restart your TV.</li> <li>■ Check if the Anynet+ Function of Anynet+ device is set on.</li> </ul>
I want to start Anynet+.	<ul style="list-style-type: none"> <li>■ Check if the Anynet+ device is properly connected to the TV and check if the Anynet+ (HDMI-CEC) is set to On in the Anynet+ Setup menu.</li> <li>■ Press the <b>TV</b> button on the TV remote control to switch to TV. Then press the <b>Anynet+</b> button to show the Anynet+ menu and select a menu you want.</li> </ul>
I want to exit Anynet+.	<ul style="list-style-type: none"> <li>■ Select <b>View TV</b> in Anynet+ menu.</li> <li>■ Press the <b>SOURCE</b> button on the TV remote control and select a device other than Anynet+ devices.</li> <li>■ Press any of <b>CH</b>, <b>CH LIST</b>, <b>PRE-CH</b>, and <b>FAV.CH</b> to change to the TV mode. (Note that the channel button operates only when an Anynet+ device with a built-in tuner is not connected.)</li> </ul>
The Connecting to Anynet+ device... message appears on the screen.	<ul style="list-style-type: none"> <li>■ You cannot use the remote control when you are configuring Anynet+ or switching to a view mode.</li> <li>■ Use the remote control when the Anynet+ setting or switching to view mode is complete.</li> </ul>
The Anynet+ device does not play.	You cannot use the play function when Plug & Play is in progress.
The connected device is not displayed.	<ul style="list-style-type: none"> <li>■ Check whether or not the device supports Anynet+ functions.</li> <li>■ Check whether or not the HDMI 1.3 cable is properly connected.</li> <li>■ Check whether Anynet+ (HDMI-CEC) is set to On in the Anynet+ setup menu.</li> <li>■ Search Anynet+ devices again.</li> <li>■ You can connect an Anynet+ device using the HDMI 1.3 cable only. Some HDMI cables may not support Anynet+ functions.</li> </ul>
The TV program cannot be recorded.	Check whether the antenna jack on the recording device is properly connected.
The TV sound is not output through the receiver.	Connect the optical cable between TV and the receiver.

# Appendix

## Troubleshooting

If the TV seems to have a problem, first try this list of possible problems and solutions.  
If none of these troubleshooting tips apply, call your nearest Samsung service center.

Problem	Possible Solution
Poor picture quality.	Try another channel. Adjust the antenna. Check all wire connections.
Poor sound quality.	Try another channel. Adjust the antenna.
No picture or sound.	Try another channel. Press the <b>SOURCE</b> button. Make sure the TV is plugged in. Check the antenna connections. Make sure the <b>MUTE</b> button is off.
No sound or sound is too low at maximum volume.	First, check the volume of units connected to your TV (digital broadcasting receiver, DVD, cable broadcasting receiver, VCR, etc.). Then, adjust the TV volume accordingly.
Picture rolls vertically.	Check all connections.
The TV operates erratically.	Unplug the TV for 30 seconds, then try operating it again.
The TV won't turn on.	Make sure the wall outlet is working.
Remote control malfunctions	Replace the remote control batteries. Clean the upper edge of the remote control (transmission window). Check the battery terminals. Press the <b>TV</b> button to put your remote control in the TV mode. Make sure the remote has batteries. Check that the "+" and "-" ends of the batteries are inserted correctly.
Digital broadcasting screen problem.	Please check the digital signal strength and input antenna.
The image is too light or too dark.	Adjust the Brightness and Contrast. Adjust the Fine tuning.
The image is too large or too small.	Adjust the Size settings.
The visual qualities of digital channels vary.	The visual qualities of digital channels may vary depending on the original production method (analog or digital). - If the original production method is digital: High visual quality. - If the original production method is analog: The digital program displayed on the screen is originally an analog program which has been converted to digital. The visual quality is of an SD(Standard Definition) grade.
Screen is black and power indicator light blinks steadily.	On your computer; check the Power and Signal Cable. The TV is using its power management system. Move the computer's mouse or press any key on the keyboard. On your equipment check (STB, DVD, etc) ; Power and Signal Cable. The TV is using its power management system. Press the Source button on the panel or remote control. Turn the TV off and on.
Although the TV caption shows HD, the visual quality is not satisfactory.	The HD(High Definition) caption that appears when switching channels or when pressing the Information button on the remote control means the selected channel is a digital channel. If the broadcasting station converts an analog signal into digital and transmits the signal, the visual quality may not be perfect.

## Installing the Wall Mount Kit

This installation is to be used when attaching the wall mount to a wall.  
When attaching to other building materials, please contact your nearest dealer.

### Wall Mount Kit Specifications ( VESA )

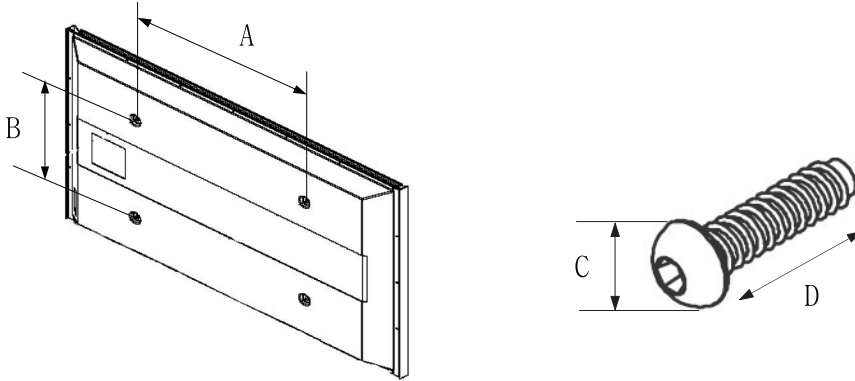

Product Family	inch	VESA Spec. (A * B)	Standard Screw (C * D)	Quantity
LCD-TV	23 ~ 26	200 * 100	M4 * L10	4
	32 ~ 40	200 * 200	M6 * L10	4
	46 ~ 52	600 * 400	M8 * L15	4
	57	700 * 400		
PDP-TV	42 ~ 50	600 * 400	M8	6
	63	No VESA		

- 1 We provide the standard dimensions for wall mount kits as shown in the table above.
- 2 When purchasing our wall mount kit, a detailed installation manual and all parts necessary for assembly are provided.
- 3 Do not use screws longer than the standard dimension, as they may cause damage to the inside of the TV set.

## How to assemble the Stand-Base (depending on the model)

Using the 6 screws for securing the stand base and the monitor, firmly attach the monitor to the stand base.  
(The exterior of the set may be different than the picture.)

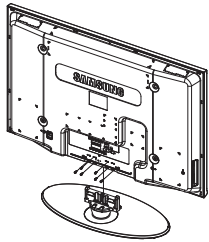

### Warning

Firmly secure the stand to the TV before moving it, as the stand may fall and could cause serious injury.

- Two or more people should carry the TV. Never lay the TV on the floor because of possible damage to the screen. Always store the TV upright.

When mounting your TV on a wall, install the cover (1) on the stand-base using two screws.

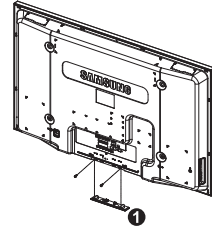

## Specifications

Model Name	HP-T4264	HP-T5064
Screen Size (Diagonal)	42 inch	50 inch
PC Resolution	1024 x 768 @ 60 Hz	1360 x 768 @ 60 Hz
Sound (Output)	10 W	15 W
Dimension (W x H x D) Body With stand	41.5 X 4.1 X 27.5 inches (1059.5 X 757 X 316 mm)	41.5 X 13.4 X 30.5 inches (1231 X 848.5 X 316 mm)
Weight Body With stand	67.6 lbs (30.7 kg) 73.8 lbs (33.5 kg)	91.4 lbs (41.5 kg) 97 lbs (44 kg)
Environmental Considerations Operating Temperature Operating Humidity Storage Temperature Storage Humidity	50 °F to 104 °F (10 °C to 40 °C) 10% to 80%, non-condensing -4 °F to 113 °F (-20 °C to 45 °C) 5% to 95%, non-condensing	

- This device is a Class B digital apparatus.
- Design and specifications are subject to change without prior notice.
- For the power supply, refer to the label attached to the product.

Stand Swivel (Left / Right)	HP-T4264/HP-T5064
<p>-20° ~ 20°</p>	Yes

# Dimensions (HP-T4264)

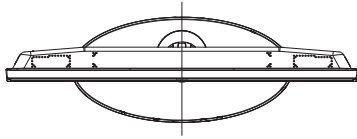

TOP VIEW

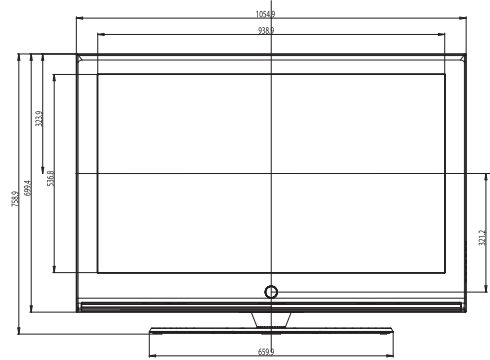

FRONT VIEW

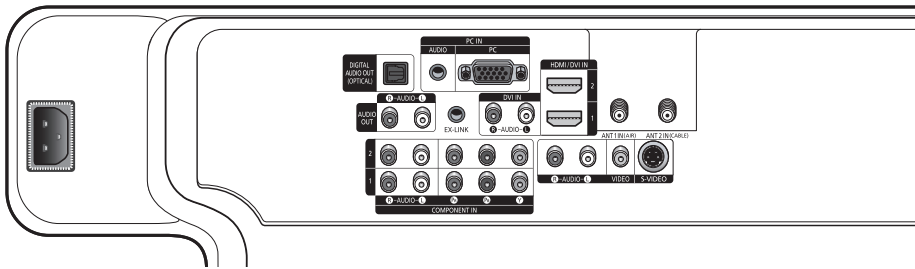

JACK PANEL DETAIL 2 1/4"H x 18 3/4"W @ 5 3/4" UP FROM BOTTOM

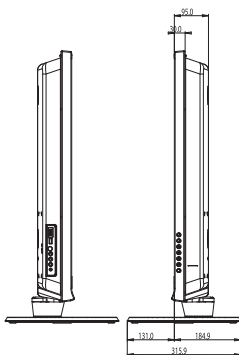

SIDE VIEW

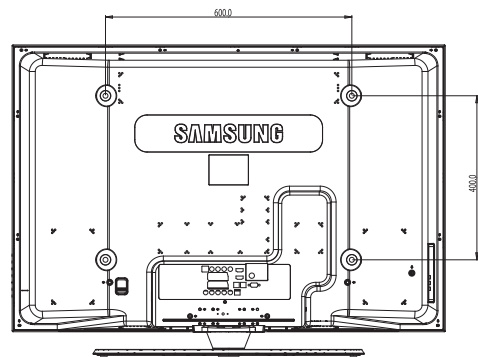

REAR VIEW

NOTE: All drawings not necessarily to scale. Some dimensions are subject to change without prior notice. Refer to dimensions on each unit prior to performing any carpentry. Not responsible for typographical or printed errors.  
© 2007 Samsung Electronics America, Inc.

# Dimensions (HP-T5064)

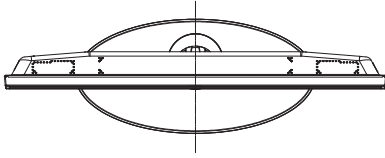

TOP VIEW

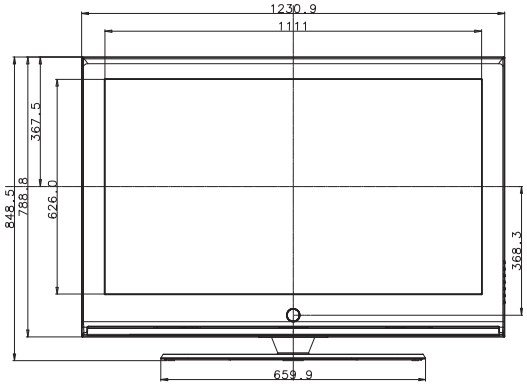

FRONT VIEW

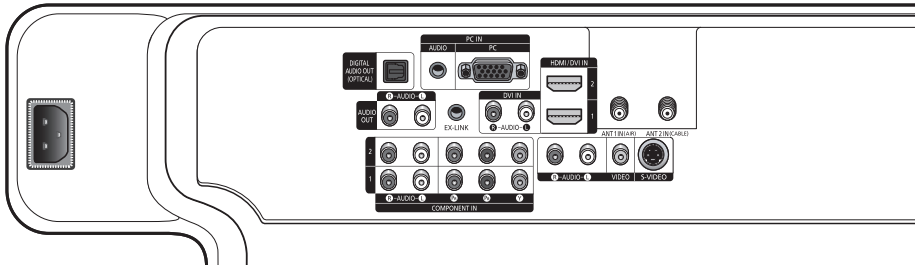

JACK PANEL DETAIL 2 1/4"H x 18 3/4"W @ 5 3/4" UP FROM BOTTOM

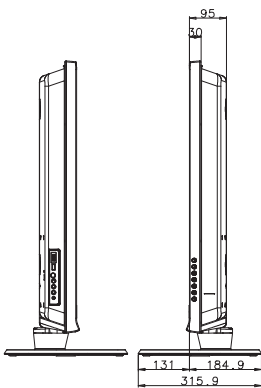

SIDE VIEW

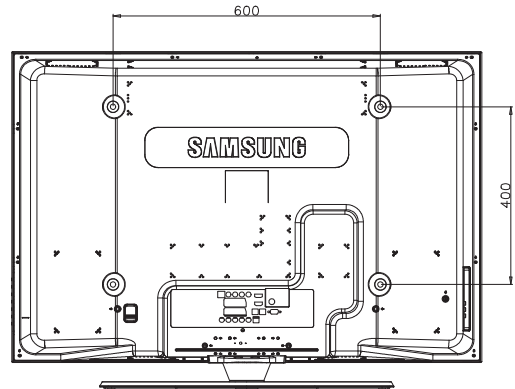

REAR VIEW

NOTE: All drawings not necessarily to scale. Some dimensions are subject to change without prior notice. Refer to dimensions on each unit prior to performing any carpentry. Not responsible for typographical or printed errors.  
© 2007 Samsung Electronics America, Inc.



***This page is intentionally  
left blank.***

***This page is intentionally  
left blank.***