

SAMSUNG

OWNER'S INSTRUCTIONS

AW069CB	AW06ECB7
AW089CB	AW08ECB7
AW109CB	AW10ECB7
AW129CB	AW12ECB7
AW149CB	AW15ECB7
AW189CB	AW18ECB7
	AW25ECB7

Window-type Room Air Conditioner (Cooling)

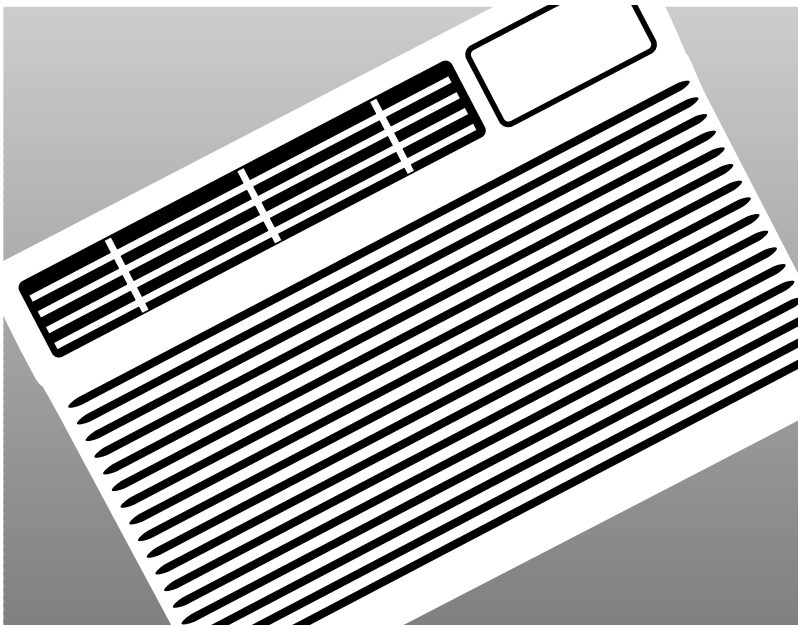

Safety Precautions

The following safety precautions must be taken when using your air conditioner.



WARNING

Risk of electric shock. • Can cause injury or death. • Disconnect all remote electric power supplies before servicing, installing or cleaning. • This must be done by the manufacturer or its service agent or a similar qualified person in order to avoid a hazard.

DURING OPERATION

- ◆ Users of this product are cautioned not to attempt repair of this product at their own discretion. Instead, they are requested to directly contact a designated service center or the outlet at which the product was purchased.
- ◆ Never spill any kind of liquid into the unit. Should this happen, unplug or switch the unit off and contact an authorized service center.
- ◆ Do not insert anything between the air outlet blades because the inner fan may be damaged and could cause injury. Keep children away from the unit.
- ◆ Do not place any obstacles in front of the unit.
- ◆ Do not spray liquid of any kind into the unit. Should this happen, switch off the breaker used for your air conditioner and contact your installation specialist.
- ◆ Make sure that the unit is correctly ventilated at all times: Do not place clothing or other materials over it.
- ◆ If the wireless remote control will not be used for a long time, remove the batteries. (If applicable)
- ◆ When using the wireless remote control, the distance should not be more than 7 meters from the air conditioner. (If applicable)
- ◆ The air conditioner must be plugged into its own specific power source, which must be installed in compliance with national wiring, grounding and safety regulations.
- ◆ If the power cord is damaged in any way, it must be replaced by the manufacturer, its service agent, or a similarly qualified person in order to avoid a hazard.
- ◆ This device must be installed according to the national electrical rules.
- ◆ After installing the appliance, the plug should be easily accessible.
- ◆ The breaker of the air conditioner should be all-pole switch; and the distance between its two contacts should be no less than 3.5mm. Such means for disconnection must be incorporated in the fixed wiring.

DISPOSING OF THE UNIT

- ◆ Before throwing out the device, it is necessary to remove the battery cells and recycle them.
- ◆ When you are ready to dispose of the unit, consult your dealer first. If pipes are removed incorrectly, refrigerant may blow out and come into contact with your skin, causing injury. Releasing refrigerant into the atmosphere also damages the environment.
- ◆ Please recycle or dispose of the packaging material for this product in an environmentally responsible manner.

OTHERS

- ◆ Never store or ship the air conditioner upside down or sideways to avoid damage to the compressor.
- ◆ The appliance is not intended for use by young children or ill persons without supervision; young children should be supervised to ensure that they do not play with the appliance.
- ◆ Max current is measured according to IEC standard for safety and current is measured according to ISO standard for energy efficiency.

Contents

◆ PREPARING YOUR AIR CONDITIONER	
■ Safety Precautions	2
■ Description of Each Component	4
■ Remote Control - Buttons	5
■ Getting Started	6
■ Inserting the Remote Control Batteries	7
◆ OPERATING YOUR AIR CONDITIONER	
■ Cooling Your Room	8
■ Airing Your Room	9
■ Removing Excess Humidity	10
■ Adjusting the Air Flow Direction Horizontally	11
■ Adjusting the Air Flow Direction Vertically	11
◆ PROGRAMMING YOUR AIR CONDITIONER	
■ Setting the On Timer	12
■ Setting the Off Timer	13
■ Setting the Sleep Timer	14
■ Selecting Energy Saving mode	15
◆ RECOMMENDATIONS FOR USE	
■ Temperature and Humidity Ranges	16
■ Cleaning Your Air Conditioner	17
■ Solving Common Problems	18
■ Technical Specifications	19
◆ INSTALLATION	20

Description of Each Component

* The design and shape are subject to change.

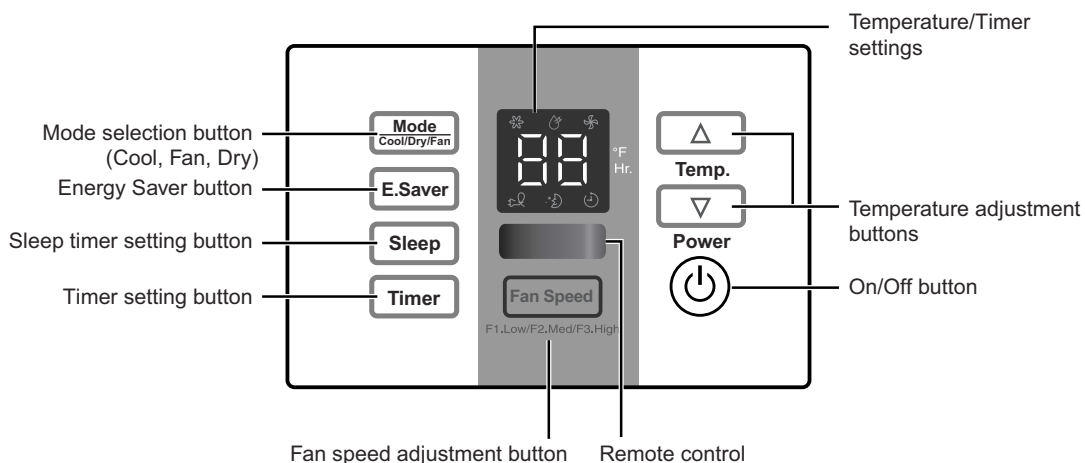
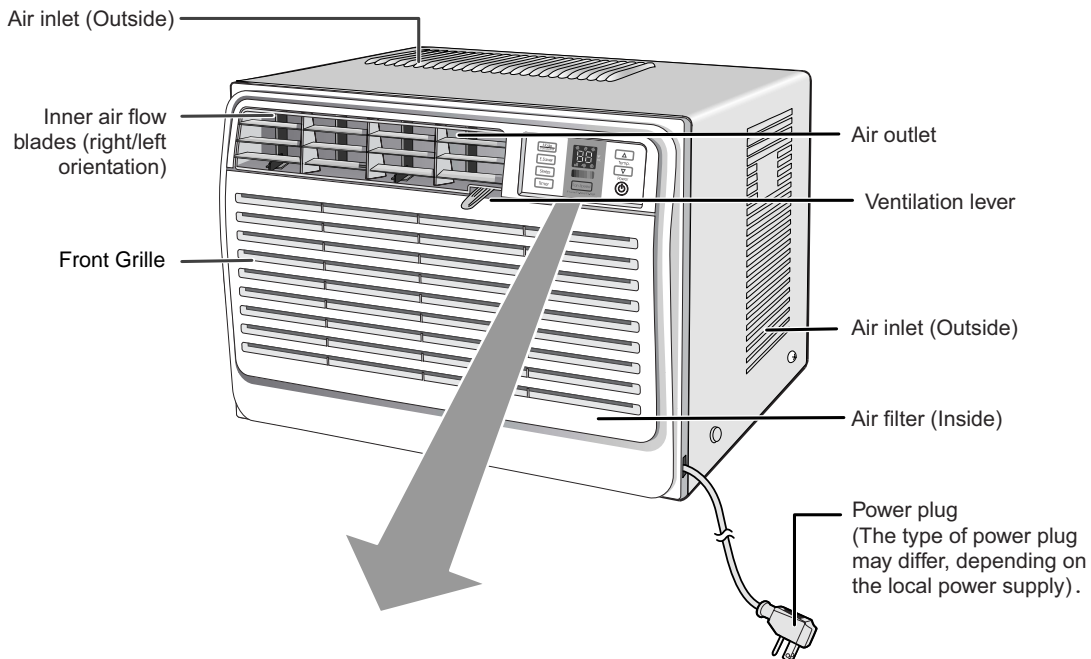

CAUTION

The power plug contains a Reset button that will automatically shut down the air conditioner in the event of a power surge. To restart the unit, press the Reset button and the unit will return to normal operation in 2-3 minutes.

Remote Control - Buttons

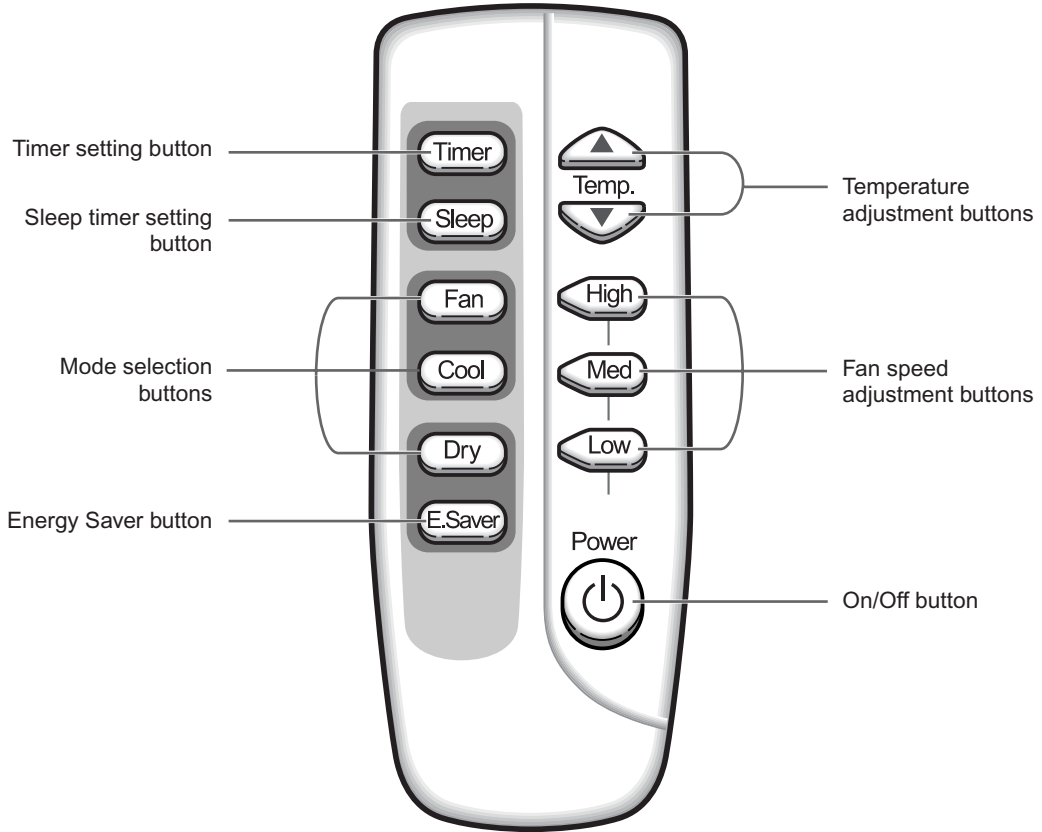

Getting Started

You have just purchased a Samsung window-type Room Air Conditioner which should be installed by following your installation manual.

Your Owner's Instructions contain valuable information on using your air conditioner. Please take the time to read them as they will help you take full advantage of the unit's features.

The booklet is organized as follows.

◆ *The following figures are shown on pages 4 and 5:*

- *Description of Each Component*
- *Remote control (buttons)*

They will help you find the buttons and understand the symbols displayed.

◆ *In the manual, you will find a series of step-by-step procedures for each function available.*

The illustrations in the step-by-step procedures use four different symbols:

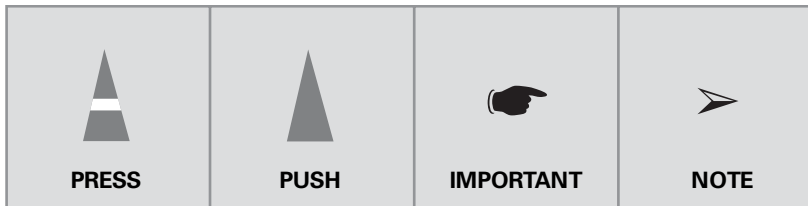

Inserting the Remote Control Batteries

You must insert or replace the remote control batteries when :

- ◆ **You purchase the air conditioner**
- ◆ **The remote control does not work correctly**

-
- ◆ Use two AAA, LR03 1.5V batteries.
 - ◆ Do not use old batteries or different kinds of batteries together.
 - ◆ Batteries may be completely discharged after 12 months, even if they have not been used.

-
- 1 Push the battery cover on the rear of the remote control with your thumb in the direction of the arrow and remove it.
-
- 2 Insert the two batteries, taking care to respect the polarities :
 - ◆ + on the battery with + on the remote control.
 - ◆ - on the battery with - on the remote control.
-
- 3 Close the cover by sliding it back until it clicks into place.
-

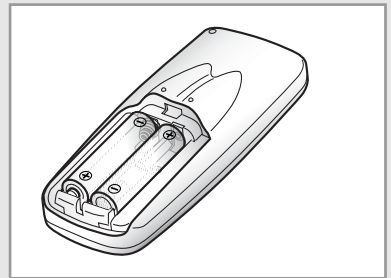
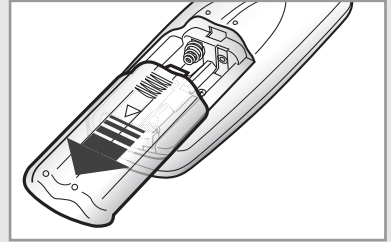

Cooling Your Room

Remote Control

Control Panel

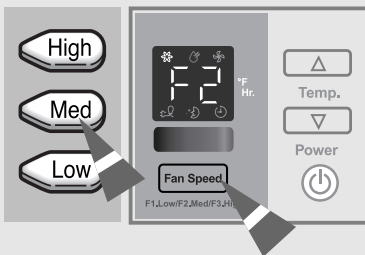
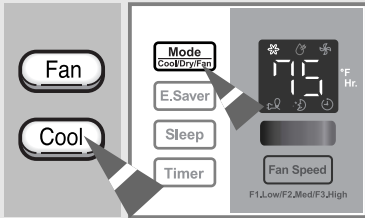

You must select the Cool mode if you wish to lower the temperature in your room. You can also set the Fan speed.

- 1 Press the (On/Off) button.

Result: ◆ The air conditioner starts up in the Cool mode.
◆ The unit beeps twice.

The air conditioner is fitted with a protection mechanism to prevent the unit from being damaged when it is started immediately after being:

- ◆ Plugged in
- ◆ Stopped

It will begin to cool after three minutes

- 2 If the temperature is not displayed on the control panel:

◆ Press the button on the remote control

or

◆ Press the button on the unit one or more times until is displayed.

Result: ◆ The unit beeps each time you press the / button.
◆ The air conditioner starts up in the Cool mode.

➤ You can change modes at any time.

- 3 To adjust the temperature, press the or buttons on the remote control or unit one or more times until the desired temperature is displayed.

The temperature can be set between 64°F and 86°F.

Result: ◆ Each time you press the or buttons:
– The temperature is adjusted by 1°F and displayed on the control panel
– The unit beeps

◆ If the room temperature is higher than the selected temperature, the air conditioner starts cooling.

◆ If the room temperature reaches the set temperature, the air conditioner stops cooling, but the fan still operates.

- 4 To set the fan speed:

◆ Press the , or button on the remote control as desired.

or

◆ Press the button on the unit one or more times until the desired Fan speed (F1, F2 or F3) is displayed.

- 5 To control the direction of the air flow, refer to page 11.



Airing Your Room



If you want to provide air circulation without cooling, you can use the Fan mode.

1 If necessary, press the  (On/Off) button.

- Result:**
- ◆ The air conditioner starts up in the Cool mode.
 - ◆ The unit beeps twice.





2 If the fan speed(F1, F2 or F3) is not displayed on the control panel:

- ◆ Press the  button on the remote control
- or
- ◆ Press the  button on the unit one or more times until the fan speed (F1, F2 or F3) is displayed.

- Result:**
- ◆ The unit beeps each time you press the  /  button.
 - ◆ The air conditioner starts up in Fan mode.

- You can change modes at any time.
When the air conditioner is in the Fan mode, the temperature cannot be set or displayed.

3 To set the fan speed:

- ◆ Press the ,  or  button on the remote control as desired.
- or
- ◆ Press the  button on the unit one or more times until the desired fan speed(F1, F2 or F3) is displayed.

4 To control the direction of the air flow, refer to page 11.

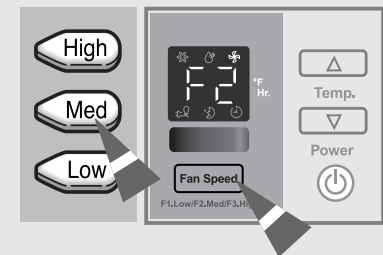
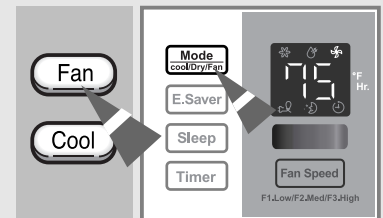
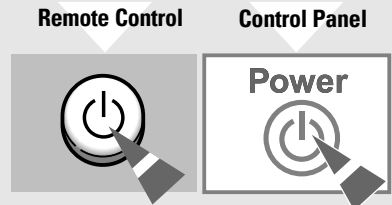

Removing Excess Humidity

Remote Control

Control Panel

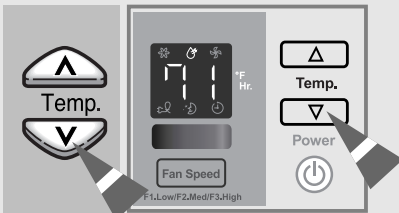
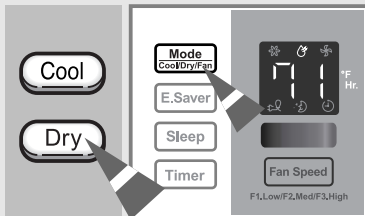

If the atmosphere in your room is very humid or damp, you can remove excess humidity without lowering the room temperature too much.

1 If necessary, press the (On/Off) button.

- Result:
- ◆ The air conditioner starts up in the Cool mode.
 - ◆ The unit beeps.

The air conditioner is fitted with a protection mechanism to prevent the unit from being damaged when it is started immediately after being:

- ◆ Plugged in
- ◆ Stopped

It will begin to cool after three minutes.

2 If the temperature is not displayed on the control panel:

- ◆ Press the button on the remote control

OR

- ◆ Press the button on the unit one or more times until is displayed.

- Result:
- ◆ The unit beeps each time you press the / button.
 - ◆ The air conditioner starts up in the Cool mode.

➤ You can change modes at any time.

3 To adjust the temperature, press the or buttons one or more times until the required temperature is displayed.

The temperature can be set between 64°F and 86°F.

Result:

- ◆ Each time you press the or buttons:
 - The temperature is adjusted by 1°F
 - The unit beeps
- ◆ The air conditioner starts removing the excess humidity; the quality of air is adjusted automatically.

4 To control the direction of the air flow, refer to page 11.

Adjusting the Air Flow Direction Horizontally

Depending on the position of the unit in your room, you can adjust the orientation of the inner air flow blades on the unit.

Adjust the inner air flow blades to the desired position by sliding them side to side.

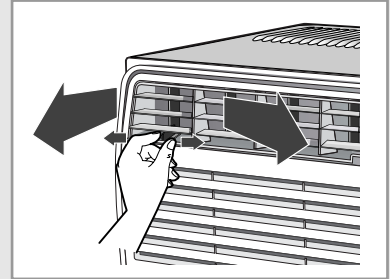

Adjusting the Air Flow Direction Vertically

The outer air flow blades can be adjusted to control the vertical air flow direction.

RECOMMENDATION	When...	Adjust the blades to face...
	Cooling	Upwards.

Adjust the outer air flow blades to the desired position, by pushing them upwards or downwards.



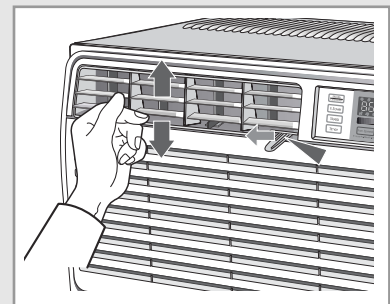

- If you position the outer air flow blades downward while the unit operates in Cool mode for long periods of time, dew may:
- Form on the surface of the blades
 - Drip from the blades

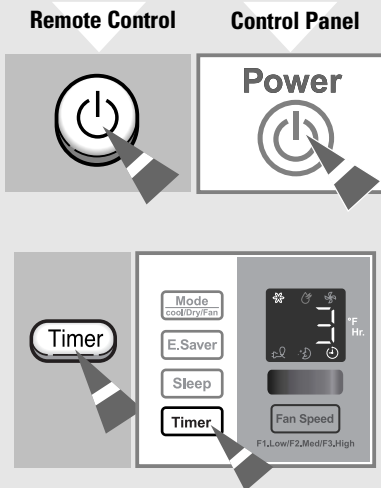

Setting the On Timer



The On Timer enables you to switch on the air conditioner automatically after a given time. You can select the On timer only when the air conditioner is off.

- 1 Check that the air conditioner has been switched off; if necessary, press the  (On/Off) button.
 - 2 Set the desired amount of time in hours before the unit will come on by pressing the  button on the remote control or  button on the unit one or more times. The countdown time can be set between 1 and 24 hours.
Result:
 - ◆ Each time you press the  button:
 - The time is adjusted by 1 hour and displayed on the control panel
 - The unit beeps
 - ◆ The countdown time is displayed and decreases automatically to indicate the remaining time.
 - ◆ The air conditioner starts up in the Cool or Dry mode automatically when the countdown time reaches zero.
- You can select the fan speed, temperature and Energy Saving mode after setting the On timer mode. You also can change the Cool or Dry mode without cancelling the On timer mode.

To Cancel the On Timer

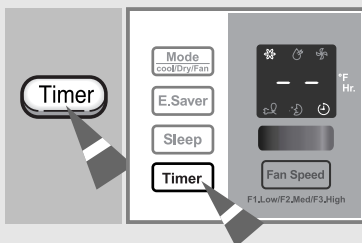



To cancel the timer, press:

- ◆ Timer on the remote control or unit one or more times until "--" is displayed.
or
- ◆ The  (On/Off) button on the remote control or unit
(The Air Conditioner returns to the previously selected operation mode.)

Setting the Off Timer

The Off Timer enables you to switch off the air conditioner automatically after a given time. You can select the Off timer only when the air conditioner is on.

- 1 Check that the air conditioner has been switched on; if necessary, press the  (On/Off) button.

- 2 Set the desired amount of time before the unit will turn off by pressing the  button on the remote control or  button on the unit one or more times until the desired time is displayed. The countdown time can be set between 1 and 24 hours.

- Result:**
- ◆ Each time you press the  button:
 - The time is adjusted by 1 hour and displayed on the control panel
 - The unit beeps
 - ◆ The countdown time is displayed and decreases automatically to indicate the remaining time.
 - ◆ The air conditioner switches off automatically when the countdown time reaches zero.

- You can select the fan speed, temperature and Energy saving mode after setting the Off timer mode. However, when you change to the fan speed mode, the Off timer mode is canceled.

Remote Control



Control Panel

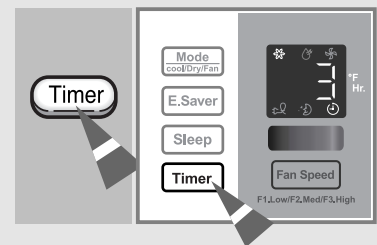

To Cancel the Off Timer

To cancel the timer, press:

- ◆ Timer on the remote control or unit one or more times until "--" is displayed.
- or
- ◆ The  (On/Off) button on the remote control or unit.

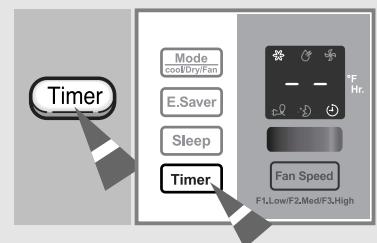

Selecting Sleep Mode

The Sleep mode can be used when you are cooling your room to switch the air conditioner off automatically after 8 hours.

➤ *The Sleep function can be set whether the air conditioner is switched on or off, and this function can be selected for any mode.*

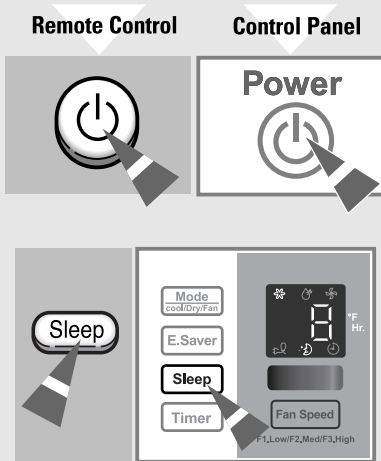

Press the **Sleep** button on the remote control
or
press the **Sleep** button on the unit.

- Result:**
- ◆ Each time you press a button, the unit beeps.
 - ◆ The $\cdot\text{D}$ indicator and " D " will be displayed.
 - ◆ The remaining time is decreased and displayed in 1 hour segments.
 - ◆ If Sleep is selected after switching on the unit, the air conditioner will run in Cool mode. During this period, the temperature displayed is the one you set for the Cool mode. If Sleep is selected before switching on the unit, the air conditioner starts runs in Cool mode and the temperature is set to 79°F.
 - ◆ The fan runs in low mode (F1), and you can adjust the speed.

To Cancel the Sleep Mode

If you no longer wish to use the Sleep mode that you have set, you can cancel it at any time.

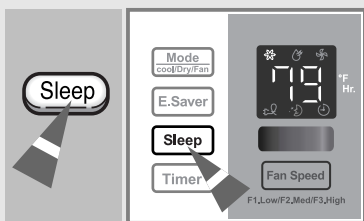

- 1 Press the **Power** button on the remote control
or
press the **Power** button on the unit
to switch off the air conditioner.
- 2 To cancel the selected Sleep mode, you can also press the **Sleep**, **E.Saver**, **Timer**, **Fan** or **Dry** button on the remote control
or
press the **Sleep**, **E.Saver**, **Mode** or **Timer** button on the unit.

- Result:**
- ◆ The unit beeps.
 - ◆ The $\cdot\text{D}$ indicator is no longer displayed.
 - ◆ The air conditioner operates in the last selected mode.

➤ If you select the Energy Saving mode in the Sleep mode, the Sleep mode will be cancelled and the air conditioner will start up in the Energy Saving mode.

Selecting Energy Saving Mode

If you wish to save energy when using your air conditioner, select the energy saving mode.

- 1 To select the energy saving mode, press the **E.Saver** button on the remote control or **E.Saver** button on the unit one or more times until the Energy Saver indicator lights up.

Result:

- ◆ The fan and compressor cycle on and off together.
- ◆ The fan will continue to run for a short time after the compressor cycles off.

- If you would like the air conditioner to run in Dry mode, do not press the **E.Saver** button. You cannot use the Dry mode in the energy saving mode.

- 2 To stop the energy saving mode, press the **E.Saver** button on the remote control or **E.Saver** button on the unit again.

Result: The fan runs at all times, while the compressor cycles on and off.

- If you select the Sleep Timer in the Energy Saving mode, the Energy Saving will be cancelled and the air conditioner will start up in the Sleep Timer mode.

Remote Control

Control Panel

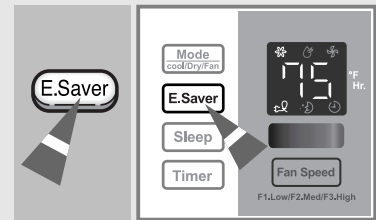

Temperature and Humidity Ranges

The following table indicates the air conditioner's temperature and humidity operation range.

Mode	Indoor Temperature	Outdoor Temperature	Indoor Humidity
Cooling	70°F to 90°F approx.	70°F to 110°F approx.	80% or less

If the air conditioner is used at...	Then...
Higher temperatures	The automatic protection feature may be triggered and the air conditioner will stop.
Lower temperatures	A water leakage or some other malfunction may happen if the heat exchanger freezes.
Higher humidity levels	Water may condense on and drip from the surface of the unit if it is used for long periods.

Cleaning Your Air Conditioner

Be sure to clean the air filter periodically to keep the air conditioner operating at optimum level.

 **When cleaning the air conditioner, turn it off and pull out the power plug.**

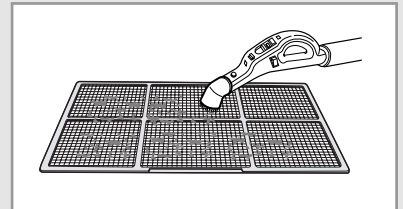
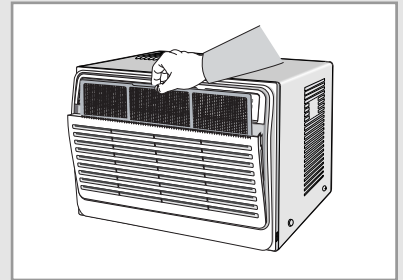
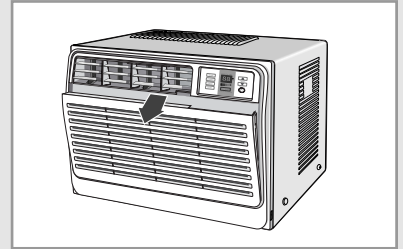

- 1 Open the front grille by pulling the tabs on both sides of the front grille. Then lift it up slightly to open the front grille completely.
- 2 Grab the tabs on the air filter and pull it up and out.
- 3 Remove all dust on the air filter with a vacuum cleaner or brush.
- 4 When you have finished, insert the air filter back into its original position.
- 5 Wipe the surface of the unit with a neutral detergent and then wipe it again with a dry cloth. (Be sure not to use benzene, solvent or other chemical products.)



 If you...	Then...
Will not be using the air conditioner for a long period of time	<ul style="list-style-type: none">◆ Switch the fan on for a few hours to thoroughly dry the inside of the air conditioner.◆ Switch the air conditioner off and unplug it from the wall socket.◆ Clean the filter and outer surfaces.
Have not used the air conditioner for a long period of time	Switch the fan on for a few hours to thoroughly dry the inside of the air conditioner.

Solving Common Problems

Before contacting a Samsung authorized service center, perform the following simple checks. They may save you the time and expense of an unnecessary call.

Problem	Explanation / Solution
The air conditioner does not operate at all	<ul style="list-style-type: none">◆ Check that the circuit breaker used for the air conditioner has not been triggered.◆ Check that the power cable is plugged into a wall socket and the socket is switched on, if necessary.◆ Check that the temperature indicator on the unit is lit; if necessary, press the  (On/Off) button on the remote control or unit.
The air conditioner does not operate with the remote control	<ul style="list-style-type: none">◆ Check that there are no obstacles between you and the unit.◆ Replace the remote control batteries if necessary.◆ Check that you are close enough to the unit (seven meters/yards or less).
No beep is heard when you press the  (On/Off) button on the remote control	<ul style="list-style-type: none">◆ Check that you are pointing the remote control at the remote control sensor on the unit.◆ Replace the remote control batteries if necessary.
The air conditioner does not cool	<ul style="list-style-type: none">◆ Check that the correct operating mode has been selected(Cool).◆ The room temperature may be too low.◆ Dust may be blocking the air filter; refer to page 17 for cleaning instructions.◆ Check that there is no obstacle blocking the air flow into or out of the unit.
The timer is not correctly triggered	<ul style="list-style-type: none">◆ Check that the timer has been programmed correctly; refer to pages 12~14.
Odors are permeating the room during air conditioning	<ul style="list-style-type: none">◆ Ventilate the room.

Technical Specifications

Design and specifications are subject to change without notice.

Model	Power Supply
AW069CB AW06ECB7 AW089CB AW08ECB7 AW109CB AW10ECB7 AW129CB AW12ECB7 AW149CB AW15ECB7	115V~, 60Hz
AW189CB AW18ECB7 AW25ECB7	230-208V~, 60Hz

INSTALLATION MANUAL



Window-Type room air conditioner

INTRODUCTION

- ◆ This brief procedure guide was prepared to supplement the user manual in helping to correctly install your room air conditioner.
- ◆ You should consider seeking a professional installation specialist if you are unsure of installing the air conditioner after reading this supplement.
- ◆ The weight and size of the unit may make it too difficult for you to install by yourself.
- ◆ If you feel you can install the air conditioner, this guide will assist you towards a safe installation. **However, please note: We are not responsible for any accident caused as a result of your attempt to install the air conditioner on your own.**
- ◆ The illustrations shown in this guide may not exactly match your air conditioner.

The following icons represent “IMPORTANT” and “NOTE” text:



IMPORTANT



NOTE

- ◆ This air conditioner should be installed in a window. To ensure product quality and safety, do not install the air conditioner in a wall.

Preparation for Installation

- ◆ Always have an assistant to help you. Never attempt to install any air conditioner alone.
- ◆ You risk the possibility of hurting yourself or injuring others by attempting to install it alone.

Checkpoints Prior to Installation

- 1 Carefully remove the unit from the packing case, lay it on the floor and check that all accessories (as indicated) are enclosed.
- 2 Check the cabinet and front grille of the unit for any defects such as scratches.
- 3 Be sure to check the power supply.
 - ◆ Refer to the specifications on the label attached to the unit.

Installation Conditions

1 Electrical Requirements

For personal safety:

- ◆ This appliance must be properly grounded.
- ◆ Do not, under any circumstances, cut or remove the third grounding prong from the power cord.
- ◆ We recommend that you do not use an extension cord or an adapter plug with this appliance.
- ◆ Do not change the plug on the power cord of this appliance.
- ◆ Follow national electrical codes or local codes and ordinances.

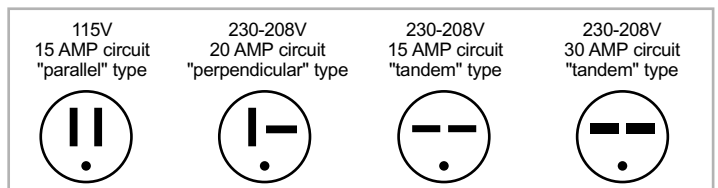

- ◆ If the electric supply provided does not meet the above specifications, call a licensed electrician.
- ◆ Aluminum house wiring may pose special problems - consult a qualified electrician.
- ◆ This unit requires a separate circuit, serving only this appliance.

Window Type Requirements

- ◆ A standard double-hung window with an actual opening width of "X." The installation will need to be modified for windows other than the standard double hung type.
- ◆ Clear a vertical opening of "Y" minimum, from bottom of sash to sill.
- ◆ Install the air conditioner in a window where there will be enough clearance around the cabinet to allow ample circulation of air through the unit.
- All supporting parts should be secured to firm wood, masonry, or metal.

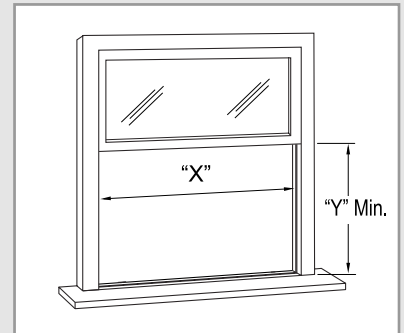

Type	Width Models	"X"	"Y"
A	AW069CB AW06ECB7	61.7cm to 91.9cm (24 3/10" to 36 1/5")	34.0cm (13 3/8")
B1	AW089CB AW08ECB7	63cm to 92cm (24 7/10" to 36 1/5")	38.0cm (14 3/4")
B2	AW109CB AW129CB AW10ECB7 AW12ECB7	66.2cm to 100cm (26" to 39 1/2")	41.0cm (16 1/8")
C	AW149CB AW18ECB7 AW189CB AW15ECB7	72.2cm to 100cm (28 2/5" to 39 2/5")	44.2cm (17 3/8")
	AW25ECB7	76.2cm to 104cm (30" to 41")	46.7cm (18 2/5")

Tools Needed (Not Supplied)

- ◆ Philips head screwdriver
- ◆ Ruler or tape measure
- ◆ Adjustable wrench
- ◆ Pencil
- ◆ Scissors

A Type AW069CB/AW06ECB7 Installation

The illustrations shown in this section may not exactly match your air conditioner.

Parts Furnished

The following accessories may be not supplied depending on the model.

Type A(Qty-6)

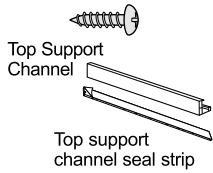

Type B(Qty-10)

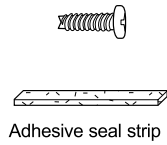

Type C(Qty-2)



Window filler panel

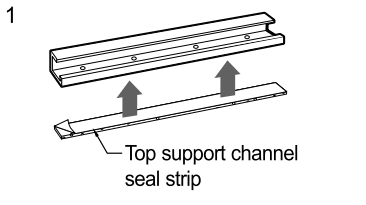

- 1 Remove the backing from the top support channel seal strip and attach it to the bottom of the top support channel.

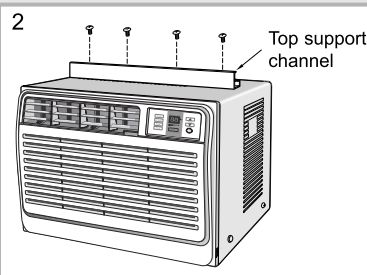

- 2 Install the top support channel with four Type B screws provided.

The screw holes are of larger gauge on the channel and smaller on the cabinet. The top support channel is "L" shaped. The high side of the channel must always face inwards.

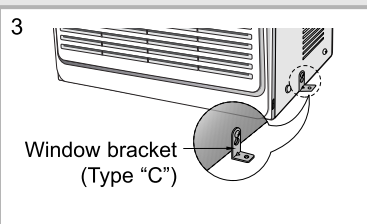

- 3 Assemble the window brackets on the cabinet.
 - 3-1 Loosen the lower screw slightly on each side of the cabinet and install the **Type C window bracket**.
 - 3-2 Tighten the screws securing the brackets.

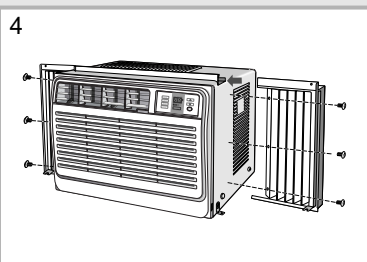

- 4 Attach the window filler panels to the unit.
 - 4-1 Slide the window filler panels and their frames into the channels on the top and bottom of the cabinet.
 - 4-2 Assemble the window filler panels to the cabinet using **six Type B screws**.

A Type AW069CB/AW06ECB7 Installation(cont.)

5 Attach the seal strip to the window.

- 5-1 Cut the adhesive-backed foam seal strip gasket to the window width.
- 5-2 Remove the backing from the adhesive seal strip and attach the strip to the underside of the bottom window.

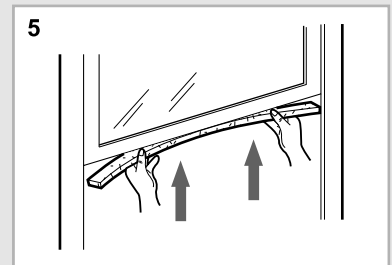

6 Install the unit in the window.

- 6-1 Place the air conditioner cabinet into the window with the top support channel positioned just in front of the bottom sash.
- 6-2 Center the cabinet, side to side in the window then pull the window down until it rests on the air conditioner, just behind the mounting channel front flange on top of the cabinet.
- 6-3 **Make sure the cabinet maintains a slightly downward slant to the outside. A 1/4" slant cabinet from front to rear is desirable to help prevent water from entering the room.**

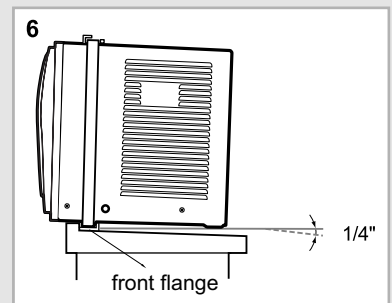

7 Extend the window filler panels.

- 7-1 Secure the window brackets to the ledge using the **Type A screw** at each side.
- 7-2 Extend the window filler panels into the window sash tracks on both sides. When the window is pulled down, the window should rest on the unit just behind the window filler panel frames.
- 7-3 Slide the window filler panels outward until they touch the sides of the window. Secure the panels by putting **four Type A screws** through the mounting holes in the panels and driving them into the window ledge and sash.

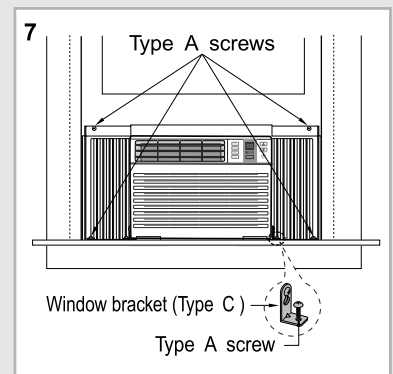

A Type AW069CB/AW06ECB7 Installation(cont.)

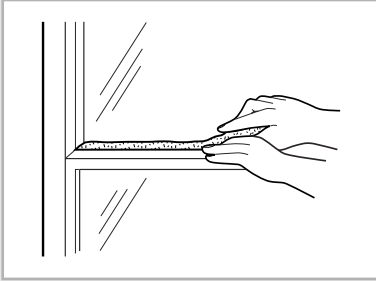

-
- 8** Install the window gasket.
Cut the foam window gasket to the window width and stuff it between the window and the glass to prevent air and insects from getting into the room.

-
- 9** Check for air leaks and seal.

-
- 10** Plug in the power cord connected to the air conditioner. Turn the air conditioner on and operate it in Cool mode.
Check to make sure there are no unusual vibrations.
- After several minutes, the unit will blow out cold air.
If the unit does not, please return it to the dealer.
-

A Type AW069CB/AW06ECB7 Installation(cont.)

Removal of the Front Grille

If you need to remove the front grille for replacement, follow the steps below.

- 1 Open the front grille by pulling the tabs on both sides of the grille. Then lift it up slightly to open the front grille completely.
- 2 Remove the screw that holds the grille in place.
 - Remove the shipping tape before pulling out the air filter, if necessary.
- 3 Disassemble the front grille.
 - 3-1 Press both sides of the cabinet in the direction of the arrow as shown in the figure.
 - 3-2 Pull the lower part of the front grille slightly forward.
 - Do not pull the bottom edge of the grille towards you more than 7.6cm(3"). Doing so may cause damage to the grille's two top tabs.
 - 3-3 Grasp the grille at both sides near the bottom and carefully lift it straight up to disengage the grille's two top tabs from slots near the top of the cabinet.
- 4 Re-install the front grille.
 - 4-1 Fix the upper front grille.
 - 4-2 Slide one side of the lower part of the front grille slightly backward.
 - 4-3 Slide the other side backward.
 - 4-4 Re-install the screw and the air filter.

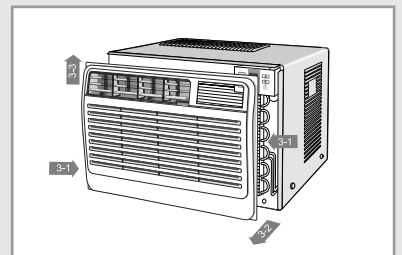
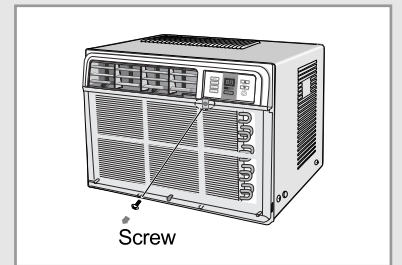
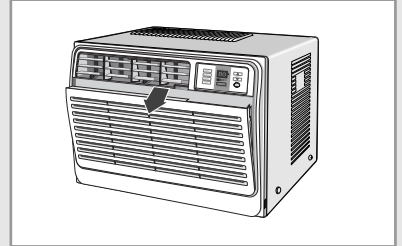

B Type

AW089CB/AW109CB/AW129CB/AW08ECB7/AW10ECB7/AW12ECB7 Installation

The illustrations shown in this section may not exactly match your air conditioner.

Parts Furnished

The following accessories may be not supplied depending on the model.

Type A(Qty-8)



Top Support Channel



Top support channel seal strip

Type B(Qty-18 or 19)



Type C(Qty-2)



Window Filler Panel

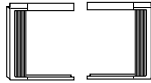

Type D(Qty-2)



Security bracket



Window sash seal

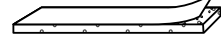

Window gasket



Bottom gasket



1

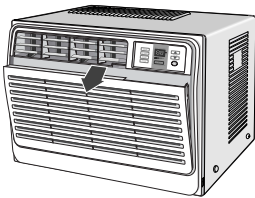

1 Open the front grille depending on the model. If necessary, refer to your owner's instructions.

2

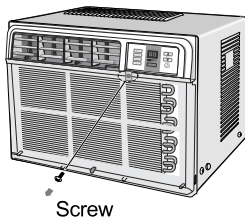

Screw

2 Remove the screw located at the lower section of the front grille. It is secured in the  section depending on the model.

3

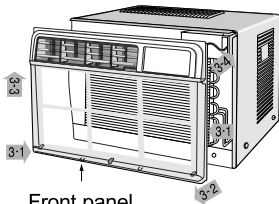

Front panel

3 Remove the front panel.

3-1 Press both sides of the cabinet in the direction of the arrow as shown in the figure.

3-2 Pull the lower part of the front panel slightly forward.
(no more than 7.6cm/3 inches)

3-3 Lift the front panel upward.

3-4 Disconnect a connector of the front panel.

➤ Applying excessive force to remove the front panel may cause damage to the tab; be sure not to use excessive force.

4

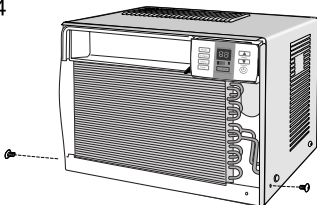

4 Remove two or four screws on the lower right and left sides of the unit.

B Type

AW089CB/AW109CB/AW129CB/AW08ECB7/AW10ECB7/AW12ECB7 Installation(cont.)

5 Carefully remove the chassis from the cabinet by pulling it forward .
(A little careful leverage with a screwdriver may help to slide the unit out.)

- Now would be an good time to inspect the fan for damage caused by shipment . Rotate the fan blade with your hands.
 - It should revolve freely without any scratching or unusual noise.
 - If such a noise exists, pack the unit up and return it to your dealer.
 - The unit may have been misaligned due to shipping abuse.

***The empty cabinet without the chassis is now relatively light.
If you have common Double Hung Windows, proceed to install the
top support channel on the cabinet.***

6 Remove the backing from the top support channel seal strip and
attach it to the bottom of the top support channel.

7 Install the top support channel with **four or five Type B screws** provided.

- Make sure to screw from the top of the cabinet onto the channel.
- The top support channel is "L" shaped. The high side of the channel must always face inwards.

8 Attach the window filler panels to the cabinet.

8-1 Slide the window filler panels and their frames into the channels on the
top and bottom of the cabinet.

8-2 Attach the window filler panels to the cabinet using **six Type B screws**.

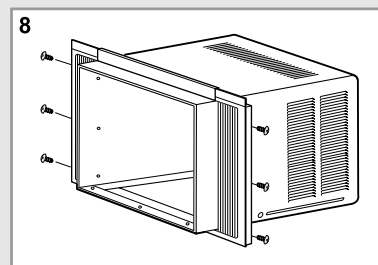
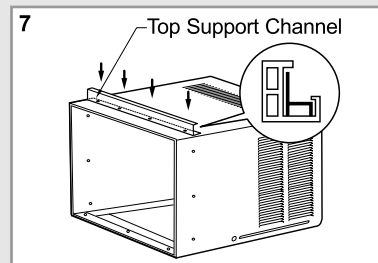
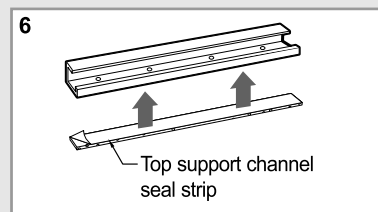
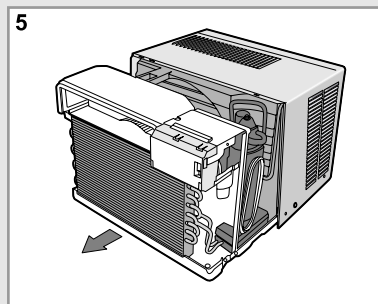

B Type

AW089CB/AW109CB/AW129CB/AW08ECB7/AW10ECB7/AW12ECB7 Installation

**Now position the cabinet centrally into the window.
Make sure you have about a five degree downward slant
to the outside for proper drainage of condensation.**

9-1

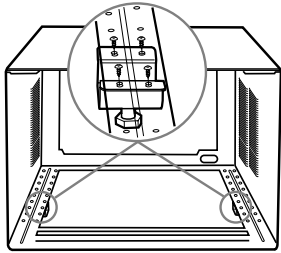

9 Attach the support brackets to the cabinet in order to adjust the pitch.

9-1 Select the **Type D support bracket** position that will place the bracket near the outermost point on the window sill. In most cabinets this will be the first set of holes. Using **eight Type B screws**, attach the support brackets to each side of the cabinet bottom.

9-2 Thread the **Type C bolts** into the support brackets, making sure the cabinet maintains a slightly downward slant to the outside.

> Some windows do not have a sufficient outside window ledge.
in such cases the brackets serve no useful purpose.

9-2

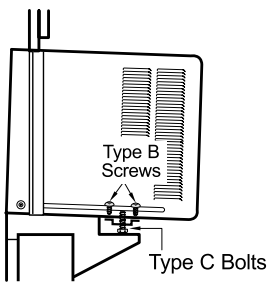

10

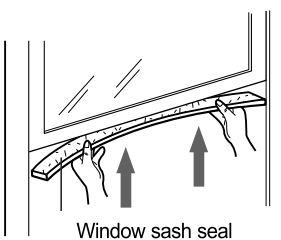

10 Attach the window sash seal to the window.

10-1 Cut the window sash seal to the window width.

10-2 Remove the backing from the window sash seal and attach it to the underside of the bottom of the window.

B Type

AW089CB/AW109CB/AW129CB/AW08ECB7/AW10ECB7/AW12ECB7 Installation(cont.)

11 Install the cabinet in the window.

- 11-1 Place the cabinet into the window with the top support channel positioned just in front of the bottom sash.
 - 11-2 Pull the window down until it rests on the cabinet, just behind the top support channel.
 - 11-3 Locate three screw holes along the cabinet bottom front edge. Center the cabinet, side to side, in the window and mount it to the window stool using three **Type A screws**.
- For safety, always make sure the bottom channel rests securely on the inside front edge of the window. If your window sill dimensions are such that this is not possible, you may need to drill three additional holes equally spaced on the bottom channel to properly secure the cabinet.
 - For some windows, it may be necessary to install 5cm(2") wide strips of hard wood positioned along the width of the window to obtain the proper alignment and pitch. The wooden strip must be screwed down securely before resting the cabinet on top of it. **Neglecting to ensure such security may risk having the air conditioner fall out of the window and hurting someone.**

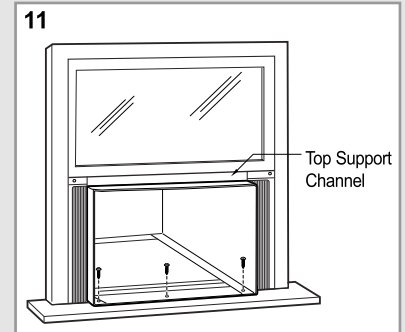

12 Extend the window filler panels.

- 12-1 When the window is pulled down, the window should rest on the cabinet just behind the window filler panel frames.
- 12-2 Slide the filler panels outward until they touch the sides of the window. Secure the panels by putting **four Type A screws** through the mounting holes in the panels and driving them into the window stool and sash.

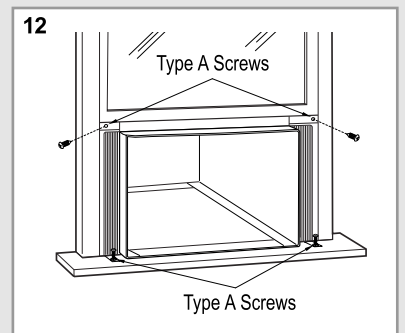

13 Attach the security bracket with a Type A screw.

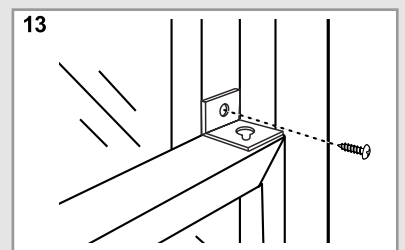

B Type

AW089CB/AW109CB/AW129CB/AW08ECB7/AW10ECB7/AW12ECB7 Installation(cont.)

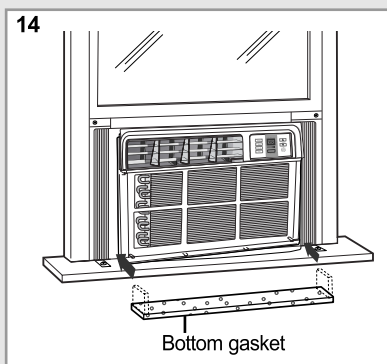

14 Slide the chassis into the cabinet.

14-1 Carefully slide the air conditioner back into the cabinet.

14-2 Place the bottom gasket between the bottom of the chassis and the inside bottom of the cabinet. Fold up the ends on both sides of the bottom gasket and push them in.

14-3 Reinstall the chassis-to-cabinet retaining screws removed on page 11.

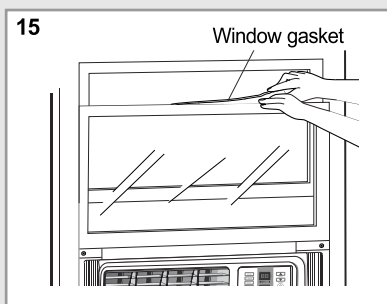

15 Install the window gasket.

Cut the window gasket to the window width and stuff it between the window and the glass to prevent air and insects from getting into the room.

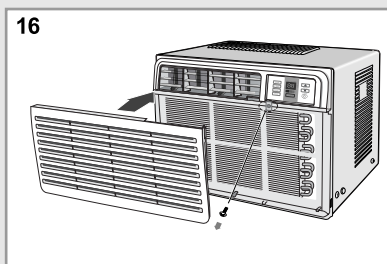

16 Reinstall the panel and grille.

16-1 Fix the upper front panel.

16-2 Slide one side of the lower part of the front panel slightly backward.

16-3 Slide the other side backward.

16-4 Reinstall the front grille to the cabinet after replacing the screw removed in step 2.

17 Check for air leaks and seal.

➤ Some installations may require additional sealing around the window and air conditioner.

18 Plug in the power, turn the air conditioner on and operate it in Cool mode and check for unusual vibrations.

➤ After several minutes the unit will be blowing out cold air. If the unit does not, please return it to the dealer.

C Type

AW149CB/AW189CB/AW15ECB7/AW18ECB7/AW25ECB7 Installation

The illustrations shown in this section may not exactly match your air conditioner.

Parts Furnished

The following accessories may be not supplied depending on the model.

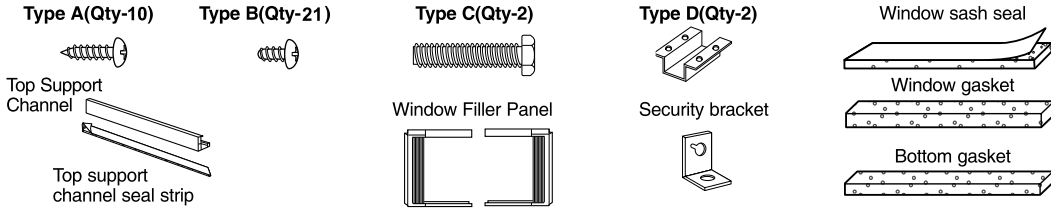

1 Open the front grille. If necessary, refer to your owner's instructions.

2 Remove the screw located at the lower section of the front grille. It is secured in the  section depending on the model.

3 Remove the front panel.

3-1 Press both sides of the cabinet in the direction of the arrow as shown in the figure.

3-2 Pull the lower part of the front panel slightly forward.
(no more than 7.6cm/3 inches)

3-3 Lift the front panel upward.

3-4 Disconnect a connector of the front panel .

➤ Applying excessive force to remove the front panel may cause damage to the tab; be sure not to use excessive force.

4 Remove four screws on the lower right and left sides of the unit.

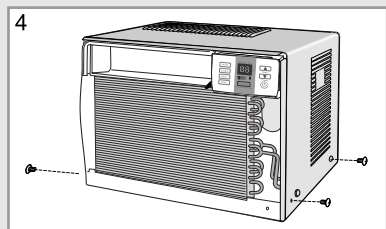
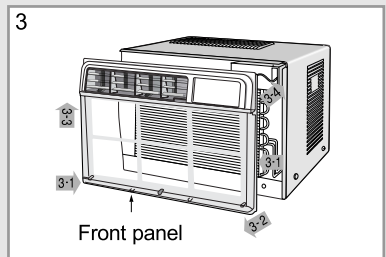
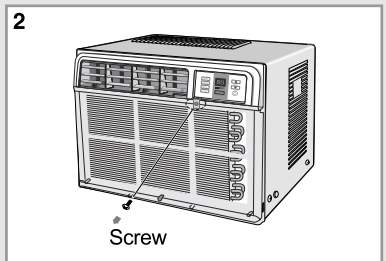
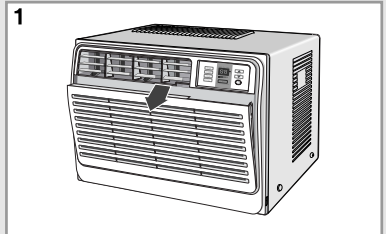

C Type

AW149CB/AW189CB/AW15ECB7/AW18ECB7/AW25ECB7 Installation(cont.)

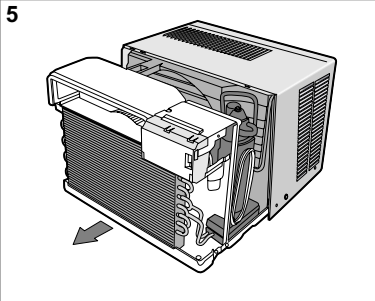

5 Carefully remove the chassis from the cabinet by pulling it forward towards you. (A little careful leverage with a screwdriver may help to slide the unit out.)

- Now would be a good time to inspect the fan for damage caused by shipment. Rotate the fan blade with your hands.
 - It should revolve freely without any scratching or unusual noise. If such a noise exists, pack the unit up and return it to your dealer. The unit may have been misaligned due to shipping abuse.

The empty cabinet without the chassis is now relatively light. If you have common Double Hung Windows, proceed to install the top support channel on the cabinet.

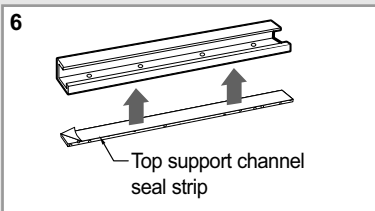

6 Remove the backing from the top support channel seal strip and attach it to the bottom of the top support channel.

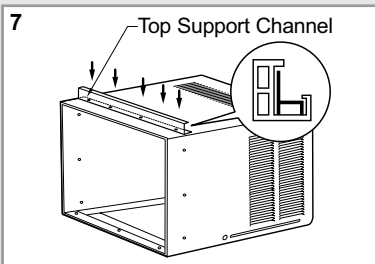

7 Install the top support channel with **five Type B screws** provided.

- Make sure to screw from the top of the cabinet onto the channel.
- The top support channel is "L" shaped. The high side of the channel must always face inwards.

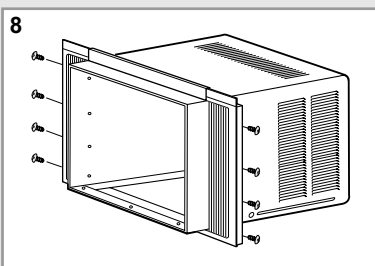

8 Attach the window filler panels to the cabinet.

8-1 Slide the window filler panels and their frames into the channels on the top and bottom of the cabinet.

8-2 Attach the window filler panels to the cabinet using **eight Type B screws**.

C Type

AW149CB/AW189CB/AW15ECB7/AW18ECB7/AW25ECB7 Installation(cont.)

**Now position the cabinet centrally into the window.
Make sure you have about a five downward slant towards
the outside backwards for proper drainage of condensation.**

9 Attach the support brackets to the cabinet for adjusting the pitch.

- 9-1 Select the **Type D support bracket** position that will place the bracket near the outermost point on the window sill. In most cabinets this will be the first set of holes. Using **eight Type B screws**, attach the support brackets to each side of the cabinet bottom.
 - 9-2 Thread the **Type C bolts** into the support brackets, making sure the cabinet maintains a slightly downward slant to the outside.
- Some windows do not have sufficient window ledge on the outside edge of the window, in such cases the brackets serve no useful purpose.

9-1

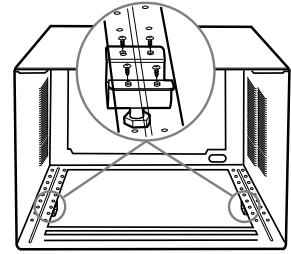

9-2

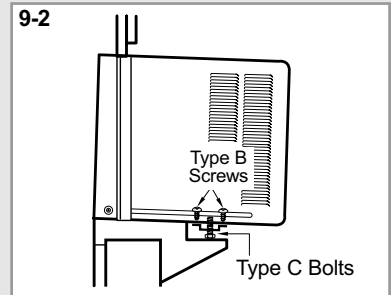

10 Attach the window sash seal to the window.

- 10-1 Cut the window sash seal to the window width.
- 10-2 Remove the backing from the window sash seal and attach it to the underside of the bottom of the window.

10

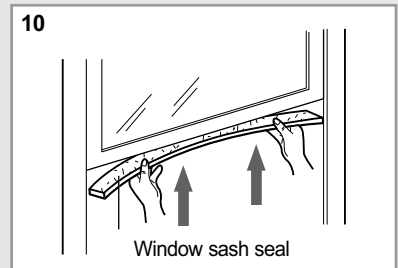

C Type

AW149CB/AW189CB/AW15ECB7/AW18ECB7/AW25ECB7 Installation(cont.)

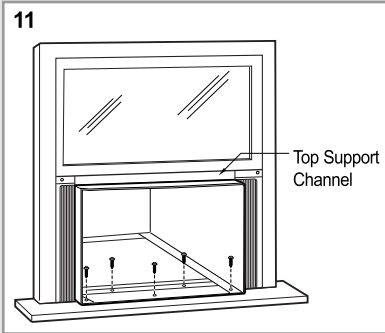

11 Install the cabinet in the window.

11-1 Place the cabinet into the window with the top support channel positioned just in front of the bottom sash.

11-2 Pull the window down until it rests on the cabinet, just behind the top support channel.

11-3 Locate five screw holes along the cabinet bottom front edge. Center the cabinet, side to side, in the window and mount it to the window stool using **five Type A screws**.

> For safety, always make sure the bottom channel rests securely on the inside front edge of the window. If your window sill dimensions are such that this is not possible, you may need to drill three additional holes equally spaced on the bottom channel to properly secure the cabinet.

> For some windows, it may be necessary to install 5cm(2") wide strips of hard wood positioned along the width of the window to obtain the proper alignment and pitch. The wooden strip must be securely screwed down before resting the cabinet on top of it. **Neglecting to ensure such security may risk having the air conditioner fall out of the window and hurting someone.**

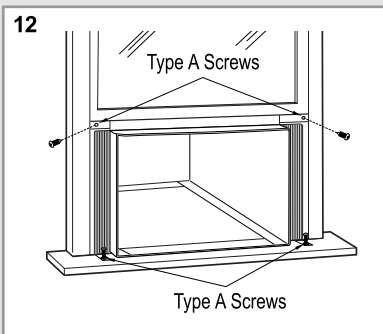

12 Extend the window filler panels.

12-1 When the window is pulled down, the window should rest on the cabinet just behind the window filler panel frames.

12-2 Slide the filler panels outward until they touch the sides of the window. Secure the panels by putting **four Type A screws** through the mounting holes in the panels and driving them into the window stool and sash.

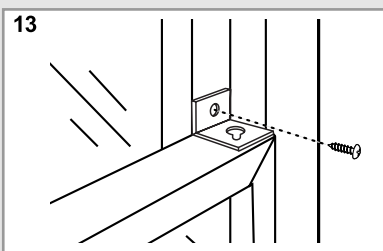

13 Attach the security bracket with a Type A screw.

C Type

AW149CB/AW189CB/AW15ECB7/AW18ECB7/AW25ECB7 Installation(cont.)

14 Slide the chassis into the cabinet.

- 14-1 Carefully slide the air conditioner back into the cabinet.
- 14-2 Place the bottom gasket between the bottom of the chassis and the inside bottom of the cabinet. Fold up the ends on both sides of the bottom gasket and push them in.
- 14-3 Reinstall 2 front screws on the side of unit among the removed screws in page 17.

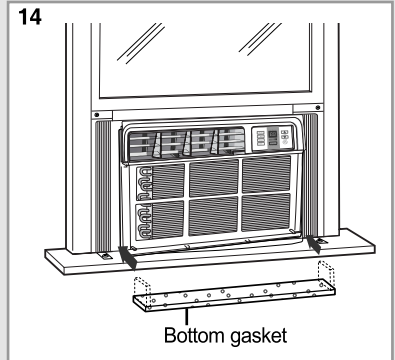

15 Install the window gasket.

Cut the window gasket to the window width and stuff it between the window and the glass to prevent air and insects from getting into the room.

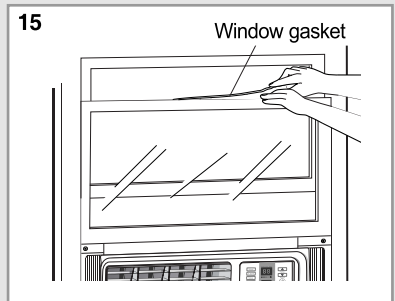

16 Reinstall the panel and grille.

- 16-1 Fix the upper front panel.
- 16-2 Slide one side of the lower part of the front panel slightly backward.
- 16-3 Slide the other side backward.
- 16-4 Reinstall the front grille to the cabinet after replacing the screw removed in step 2.

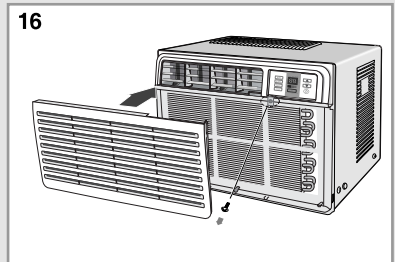

17 Check for air leaks and seal.

- Some installations may require additional sealing around the window and air conditioner.

18 Plug in the power, turn the air conditioner on, operate it in Cool mode and check for unusual vibrations.

- After several minutes the unit will be blowing out cold air. If the unit does not, please return it to the dealer.
-

SAMSUNG ROOM AIR CONDITIONER

LIMITED WARRANTY TO ORIGINAL PURCHASER

This SAMSUNG brand product, as supplied and distributed by SAMSUNG ELECTRONICS AMERICA, INC. (SAMSUNG) and delivered new, in the original carton to the original consumer purchaser, is warranted by SAMSUNG against manufacturing defects in materials and workmanship for a limited warranty period of:

Five (5) Years Parts, Labor and Compressor Warranty

This limited warranty begins on the original date of purchase, and is valid only on products purchased and used in the United States. Warranty repairs must be performed by SAMSUNG's authorized service center. To receive warranty service, the original dated bill of sale must be presented upon request as proof of purchase to SAMSUNG or SAMSUNG's authorized service center.

SAMSUNG will repair or replace any part found to be defective at no charge, as stipulated herein, with new or reconditioned parts during the limited warranty period specified above. To request warranty service, the purchaser must contact SAMSUNG for problem determination and service procedures. SAMSUNG does not warrant uninterrupted or error-free operation of the product. All replaced parts and products become the property of SAMSUNG and must be returned to SAMSUNG. Replacement parts and products assume the remaining original warranty, or ninety (90) days, whichever is longer.

In - Home Service :

During the warranty labor period, in-home service will be provided subject to availability within the contiguous United States. In-home service is not available in all areas. If during in-home service repair can not be completed, it may be necessary to remove, repair and return the product. If in-home service is unavailable, SAMSUNG may elect, at our option, to provide for transportation of our choice to and from a SAMSUNG authorized service center. Otherwise, transportation to and from the SAMSUNG authorized service center is the responsibility of the purchaser.

This limited warranty covers manufacturing defects in materials and workmanship encountered in normal, noncommercial use of this product and shall not apply to the following, including, but not limited to: delivery and installation; damage which occurs in shipment; applications and uses for which this product was not intended; failures or problems which are caused by products or equipment not supplied by SAMSUNG; accidents, misuse, abuse, neglect, misapplication, fire, water, lightning or other acts of nature; incorrect electrical line voltage, fluctuations or surges; damage caused by improper or faulty installation; product alteration or modification; improper or unauthorized repair; cosmetic damage or exterior finish; product with altered serial numbers; failure to follow operating and environmental instructions that are covered and prescribed in the instruction book; customer adjustments, routine maintenance and cleaning; consumable items such as filters; use of non-SAMSUNG or unauthorized parts, supplies, accessories or equipment which damage this product or result in service problems.

THERE ARE NO EXPRESS WARRANTIES OTHER THAN THOSE LISTED AND DESCRIBED ABOVE, AND NO WARRANTIES WHETHER EXPRESS OR IMPLIED, INCLUDING, BUT NOT LIMITED TO, ANY IMPLIED WARRANTIES OF MERCHANTABILITY OR FITNESS FOR A PARTICULAR PURPOSE, SHALL APPLY AFTER THE EXPRESS WARRANTY PERIODS STATED ABOVE, AND NO OTHER EXPRESS WARRANTY OR GUARANTY GIVEN BY ANY PERSON, FIRM OR CORPORATION WITH RESPECT TO THIS PRODUCT SHALL BE BINDING ON SAMSUNG. SAMSUNG SHALL NOT BE LIABLE FOR LOSS OF REVENUE OR PROFITS, FAILURE TO REALIZE SAVINGS OR OTHER BENEFITS, OR ANY OTHER SPECIAL, INCIDENTAL OR CONSEQUENTIAL DAMAGES CAUSED BY THE USE, MISUSE OR INABILITY TO USE THIS PRODUCT, REGARDLESS OF THE LEGAL THEORY ON WHICH THE CLAIM IS BASED, AND EVEN IF SAMSUNG HAS BEEN ADVISED OF THE POSSIBILITY OF SUCH DAMAGES. NOR SHALL RECOVERY OF ANY KIND AGAINST SAMSUNG BE GREATER IN AMOUNT THAN THE PURCHASE PRICE OF THE PRODUCT SOLD BY SAMSUNG AND CAUSING THE ALLEGED DAMAGE. WITHOUT LIMITING THE FOREGOING, PURCHASER ASSUMES ALL RISK AND LIABILITY FOR LOSS, DAMAGE OR INJURY TO PURCHASER AND PURCHASERS PROPERTY AND TO OTHERS AND THEIR PROPERTY ARISING OUT OF THE USE, MISUSE OR INABILITY TO USE THIS PRODUCT SOLD BY SAMSUNG NOT CAUSED DIRECTLY BY THE NEGLIGENCE OF SAMSUNG. THIS LIMITED WARRANTY SHALL NOT EXTEND TO ANYONE OTHER THAN THE ORIGINAL PURCHASER OF THIS PRODUCT. IT IS NON-TRANSFERABLE AND STATES YOUR EXCLUSIVE REMEDY.

Some states do not allow limitations on how long an implied warranty lasts, or the exclusion or limitation of incidental or consequential damages, so the above limitations or exclusions may not apply to you. This warranty gives you specific legal rights, and you may also have other rights which vary from state to state.

To obtain warranty service, please contact SAMSUNG at

SAMSUNG ELECTRONICS AMERICA, INC. - CONSUMER ELECTRONICS CUSTOMER SERVICE
105 Challenger Road Ridgefield Park, NJ 07660-0511
1-800-SAMSUNG (1-800-726-7864)
www.samsung.com